

THIS DRAWING IS UNPUBLISHED. RELEASED FOR PUBLICATION 20
 © COPYRIGHT 20 BY - ALL RIGHTS RESERVED.

REVISIONS					
P	LTR	DESCRIPTION	DATE	DWN	APVD
	A	INITIAL RELEASE	29MAY2019	OL	SZ

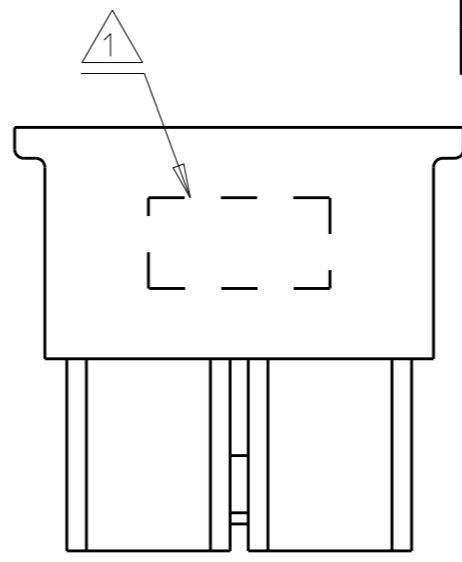

- NOTES:
1. PART NUMBER AND DATE CODE.
 2. MATERIAL: THERMO PLASTIC, UL94 V-0, COLOR: SEE PART NUMBER LIST.
 3. THIS RECEPTACLE HOUSING TO BE USED WITH RECEPTACLE TERMINAL 2204749.
 4. PACKAGED IN BULK BY BAG.

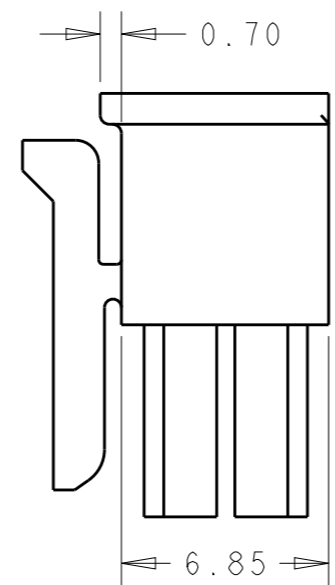
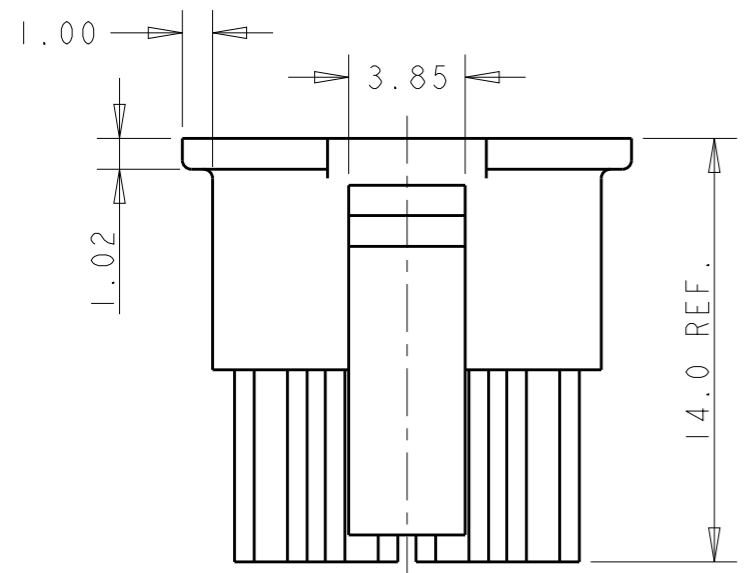
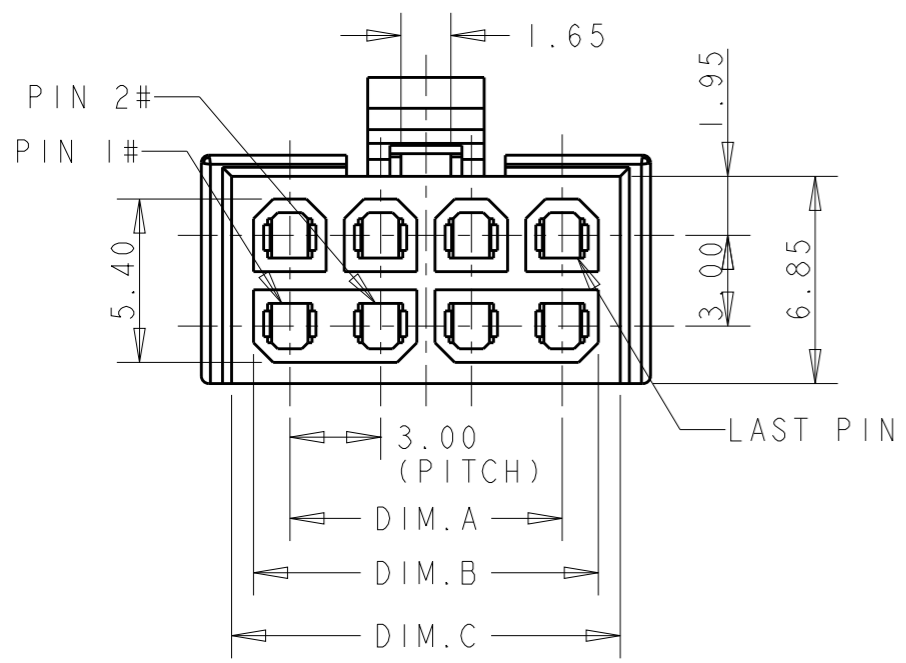

36.85	35.40	33.00	NATURE	24	2-2204748-4
33.85	32.40	30.00	NATURE	22	2-2204748-3
30.85	29.40	27.00	NATURE	20	2-2204748-2
27.85	26.40	24.00	NATURE	18	2-2204748-1
24.85	23.40	21.00	NATURE	16	2-2204748-0
21.85	20.40	18.00	NATURE	14	1-2204748-9
18.85	17.40	15.00	NATURE	12	1-2204748-8
15.85	14.40	12.00	NATURE	10	1-2204748-7
12.85	11.40	9.00	NATURE	8	1-2204748-6
9.85	8.40	6.00	NATURE	6	1-2204748-5
6.85	5.40	3.00	NATURE	4	1-2204748-4
3.85	2.40	N/A	NATURE	2	1-2204748-3
DIM.C	DIM.B	DIM.A	COLOR	CIRCUIT	PART NUMBER

36.85	35.40	33.00	BLACK	24	1-2204748-2
33.85	32.40	30.00	BLACK	22	1-2204748-1
30.85	29.40	27.00	BLACK	20	1-2204748-0
27.85	26.40	24.00	BLACK	18	2204748-9
24.85	23.40	21.00	BLACK	16	2204748-8
21.85	20.40	18.00	BLACK	14	2204748-7
18.85	17.40	15.00	BLACK	12	2204748-6
15.85	14.40	12.00	BLACK	10	2204748-5
12.85	11.40	9.00	BLACK	8	2204748-4
9.85	8.40	6.00	BLACK	6	2204748-3
6.85	5.40	3.00	BLACK	4	2204748-2
3.85	2.40	N/A	BLACK	2	2204748-1
DIM.C	DIM.B	DIM.A	COLOR	CIRCUIT	PART NUMBER

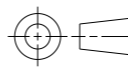
THIS DRAWING IS A CONTROLLED DOCUMENT.		DWN 9-Aug-18 RADAR SUN	 TE Connectivity	
DIMENSIONS: mm		CHK 9-Aug-18 SUNY ZHAO		
TOLERANCES UNLESS OTHERWISE SPECIFIED:		APVD 9-Aug-18 SUNY ZHAO	NAME ELCON MICRO POWER CONNECTOR, RECEPTACLE, HOUSING, 3.00MM PITCH, 2XN CIRCUITS	
 0 PLC ± 1 PLC ±0.30 2 PLC ±0.20 3 PLC ± 4 PLC ± ANGLES ±		PRODUCT SPEC 108-128068	SIZE CAGE CODE DRAWING NO RESTRICTED TO	
MATERIAL		APPLICATION SPEC	A300779 C-2204748	
FINISH		WEIGHT	SCALE 4:1 SHEET 1 OF 2 REV A	
		CUSTOMER DRAWING		

REVISIONS

P	LTR	DESCRIPTION	DATE	DWN	APVD
	-	SEE SHEET 1	-	-	-

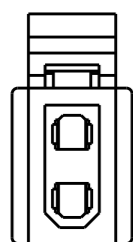

CIRCUIT SIZE:2

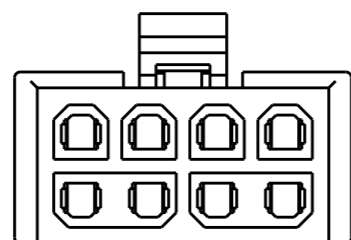

CIRCUIT SIZE:8

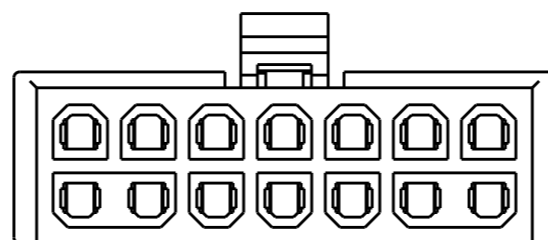

CIRCUIT SIZE:14

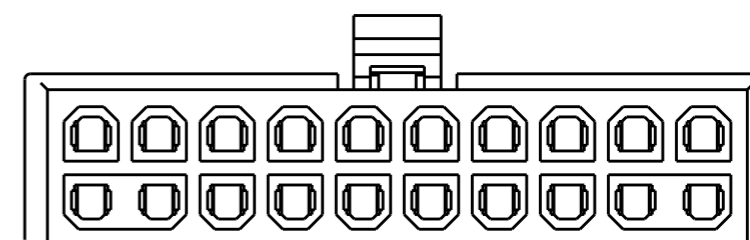

CIRCUIT SIZE:20

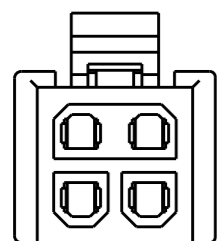

CIRCUIT SIZE:4

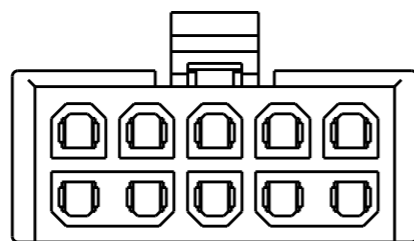

CIRCUIT SIZE:10

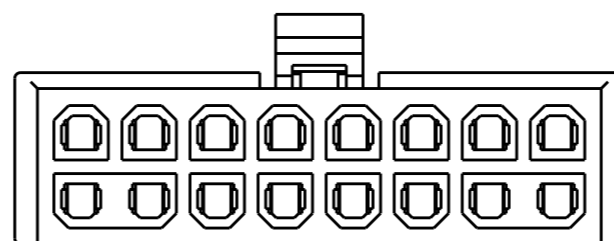

CIRCUIT SIZE:16

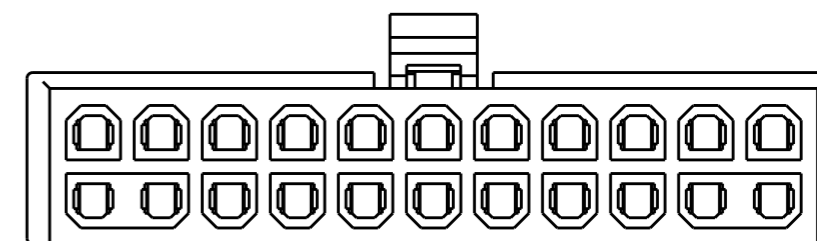

CIRCUIT SIZE:22

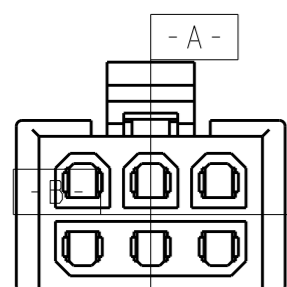

CIRCUIT SIZE:6

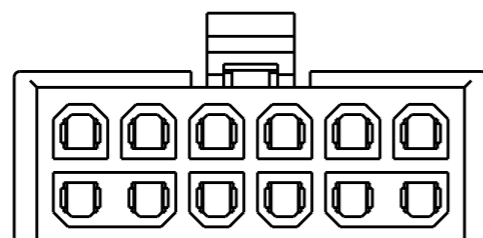

CIRCUIT SIZE:12

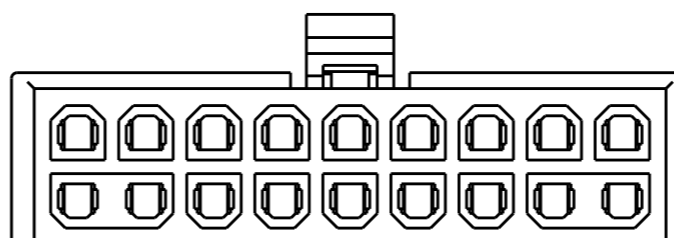

CIRCUIT SIZE:18

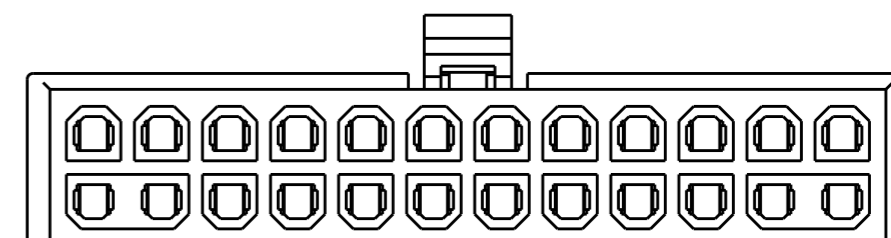

CIRCUIT SIZE:24

THIS DRAWING IS A CONTROLLED DOCUMENT.

DIMENSIONS:

mm

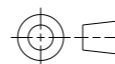

TOLERANCES UNLESS OTHERWISE SPECIFIED:

- 0 PLC ±-
- 1 PLC ±±0.30
- 2 PLC ±±0.20
- 3 PLC ±-
- 4 PLC ±-
- ANGLES ±-

MATERIAL

-

FINISH

-

DWN 9-Aug-18

RADAR SUN

CHK 9-Aug-18

SUNY ZHAO

APVD 9-Aug-18

SUNY ZHAO

PRODUCT SPEC

108-128068

APPLICATION SPEC

-

WEIGHT

-

CUSTOMER DRAWING



TE Connectivity

NAME
 ELCON MICRO POWER CONNECTOR,
 RECEPTACLE, HOUSING,
 3.00MM PITCH, 2XN CIRCUITS

SIZE	CAGE CODE	DRAWING NO	RESTRICTED TO
------	-----------	------------	---------------

A3	00779	C-2204748	-
----	-------	-----------	---

SCALE	SHEET	OF	REV
3:1	2	2	A

Mouser Electronics

Authorized Distributor

Click to View Pricing, Inventory, Delivery & Lifecycle Information:

[TE Connectivity:](#)

[2204748-8](#)