

Power Matters.

RF & Microwave Diode and Transistor Products



Microsemi RFIS Integrated Solutions

RF & Microwave Diode and Transistor Products

Within this short form catalog are the combined product selection guides for Microsemi RF Integrated Solutions (RFIS) business unit RF & microwave diodes and power transistors. RFIS diode products are primarily designed, manufactured, and tested at our Lowell Massachusetts facility and the power transistors are primarily designed, manufactured, and tested at our Santa Clara California facility. For sales and technical assistance consult our website, manufacturer's representative or distributor in your area, or contact the appropriate organization directly:

Diode Products:

Microsemi Corporation
RF Integrated Solutions
75 Technology Drive
Lowell, MA 01851-5293
+1.978.442.5600
+1.978.937.3748

Power Transistor Products:

Microsemi Corporation
RF Integrated Solutions
3000 Oakmead Village Drive
Santa Clara, CA 95051-0808
+1.408.986.8031
+1.408.986.8120

www.microsemi.com

email: sales.support@microsemi.com

Table of Contents

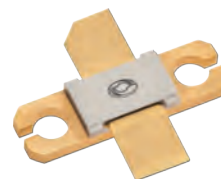

Diode Products

Overview: Diode Products	4
PIN Diodes Selection Guide	5
Power Handling Reference	6
GC4200 Series: Small Signal/High Speed Switching	7
GC4400 Series: Large Signal Switching/Attenuator	7
GC4700 Series: Limiter PIN Diodes	8
GC4800 Series: Planar Beam Lead PIN's	8
GC4900 Series: Mesa Beam Lead PINs	8
SM Ceramic MELF PINs	9
RoHS and MRI Models	9
Monolithic Microwave Surface Mount PIN Diodes	10
MRI PIN Diode Selector Guide	11
Power PIN Diodes for Switching and Attenuation	12
Schottky Diodes Selector Guide	13
Enhanced Performance Surface Mount Products	14
Varactor Performance Guide	15
Tuning Varactor Selector Guide	16
MMSM Varactor Diodes	17
GaAs Varactor Diodes	18
Gunn Diodes	19
Comb Generators	20
Surface Mount Limiter	20
Pin Diode Limiter Assemblies	21
Switch Components	22
RF, Microwave & mmWave Packages	23-25

Power Transistor Products

About RF & Microwave Power Transistor Products	26-27
GaN & SiC & SiC Wide Band Gap	28
Pulsed High Power Pallets	29
Pulsed Primary Radar	30-31
Avionics	32-33
High Reliability Transistorsb	34-35
HF/VHF/UHF Communications	36-37
Broadcast / TV	38
Microwave	38
General Purpose & Small Signal	39
Linear Class A & AB	40
Bias Devices	40
Transistor Case Styles	41-42

RF & Microwave Diode and Control Components

Microsemi's RF diode and control component operations, located in Lowell, Massachusetts, brings over 30 years experience in manufacturing of high reliability RF and microwave products. We supply a full range of Silicon and Gallium Arsenide diodes, including PIN and limiter diodes, tuning and multiplier varactors, noise diodes, Schottky-barrier diodes, MNS chip capacitors and Gunn Diodes. We are able to leverage these best in class products in our solid state control components and sensor products. Our extensive product base allows us to support frequencies from 100 Hz through millimeter wave.

With high volume wafer fabrication now in place to meet the competitive needs of our growing commercial and medical customer base, Microsemi's Lowell facility can deliver more cost-effective components faster than ever for our longstanding military customers as well.

From our closely controlled RF/microwave diode inventory we can match characteristics precisely to maintain consistent component performance levels over the full life of your system designs.

Our Lowell operation builds RF and microwave PIN diode switches, limiters, comb generators, attenuators, phase shifters, and detectors in frequency ranges to 40 GHz. All can be hermetically sealed to meet the most stringent military or space requirements and can be combined to include several functions in a single high reliability package. Typical of these integrated packages are switch/limiters, limiter/detectors, switch matrices and switched filters..

Integrated packages can provide higher performance benefits at lower cost than by designing with individual components. To assure the engineering expertise that will attain your desired performance levels, Microsemi only provides assemblies where we can control the high-risk components. In that way, we're able to develop custom packaging that meets your most demanding specifications.

In addition, we are continuing to develop low cost surface mount PIN and Limiter solutions which offer performance more often associated with expensive chip and wire bonding assemblies. They are available in several reflow friendly configurations which allow the customer new opportunities for economical designs.

Microsemi also can offer a significant number of existing configurations to minimize your NRE and provides many customers with microwave components no longer available from their original suppliers. Our extensive library of products and designs gives us the ability to respond quickly with solutions to meet your needs, quickly and cost effectively.

PIN Diodes

- Microsemi has a wide variety of GaAs and Silicon PIN diodes to suit your requirements
- From ultra-low C_j , Beam Lead PIN diodes for broadband switching to high power PIN diodes
- Designed for low frequency, low intermod switching and attenuation

PIN Diode Selection Guide

HIGH SPEED MICROWAVE SWITCHING: Chips & Beam Leaded							
Max Freq (GHz)	Typical C_j (@ V_{pt}) (pF)	40V	50V	70V/75V	100V	250V	Outline
40	0.01					MP61001	GaAs Chip
24	0.03	MP6250	GC4946		GC4801		Beam Leads / GaAs Flip Chip
18	0.06			GC4270	GC4210	GC4220	Chips
12	0.1			GC4271	GC4211	GC4221	Chips
8	0.2		MPP4203	GC4272	GC4212	GC4222	Chips / MMSM™
4	0.50			GC4273	GC4213	GC4223	Chips
2	0.75			GC4275	GC4215	GC4225	Chips

HIGH SPEED MICROWAVE SWITCHING: Packaged							
Max Freq (GHz)	Typical C_T (@ V_{pt}) (pF)	25V	40V/50V	70V/75V	100V	200V/250V	Pkg Type
40	0.02		MP6250				Flip Chip GaAs
24	0.03					MP61001	Ceramic GaAs
18	0.06				MP61004		Ceramic / GaAs
12	0.1		MPP4203	GC4270	GC4210	GC4220	Ceramic / MMSM™
8	0.2	MPP4204		GMP4201	GMP4211	GC4221	Ceramic / GigaMite
4	0.50			GMP4202	GMP4212	GC4222	Ceramic / GigaMite / EPSM
2	0.75			GC4273	GMP4215	GMP4235	Ceramic / GigaMite / EPSM
1	1.2			GC4275	GC4215	GC4225	Ceramic / GigaMite / EPSM

MED - HIGH POWER RF SWITCHING & ATTENUATION: CHIPS							
Max Freq (GHz)	Typical C_j (@ V_{pt}) (pF)	100V	300V	500V	750V	1500V	Outline
18							
12	0.1	GC4410	GC4430		GC4490		Chips
8	0.2	GC4411	GC4431		GC4491		Chips
4	0.5	GC4412	GC4432		GC4492		Chips
2	1	GC4413	GC4433		GC4493		Chips
1	2				GC4494	GC4600	Chips
0.5	4.0					GC4601	Chips

MED - HIGH POWER RF SWITCHING & ATTENUATION: Packaged										
Max Freq (GHz)	Typical C_T (@ V_{pt}) (pF)	100V	300V	500V	600V	750V	1000V	1500V	2000V	Pkg Type
12										
8	0.2	GC4410	GC4430			GC4490				Ceramic
4	0.5	GC4411	GC4431	SM0502	UM6006	GC4491				Ceramic
2	1	GC4413	GC4433	SM0509	UM6606	GC4493		GC4600		Ceramic/MELF/Leaded/Stud
1	2	UM4301			UM4306		UM4310	GC4601		Ceramic/MELF/Leaded/Stud
0.5	4.0						HUM2010	HUM2015	HUM2020	Ceramic/MELF/Leaded/Stud

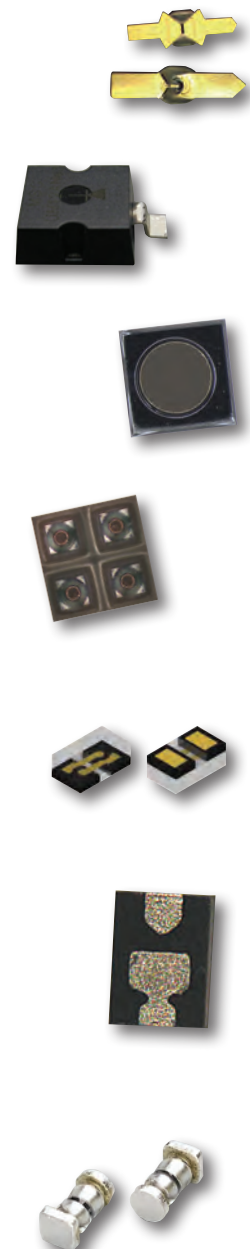

PIN Diode Power Handling

Typical PIN Diode Power Handling (CW)

PIN Family	Frequency Band (GHz)							
	0.1-0.5	0.5-1.0	1.0-2.0	2.0- 4.0	4.0-12	12-18	18-40	> 40
	HUM Series	UM / GC4600 Series	UM / GC4600 GC4700 Series	GC4400 GC4200 GC4700 Series	GC4400 GC4200 GC4700 Series	GC4200 GC4700 GC4900 Series	GC4800 / GaAs MP Series	GaAs MP Series
Typ. Junction Capacitance	4 pF	2 pF	1 pF	0.5 pF	0.2 pF	0.1 pF	0.05 pF	< 0.05 pF
Incident Power								
+60 dBm	OK	MARGINAL	NO	NO	NO	NO	NO	NO
+50 dBm	OK	OK	MARGINAL	MARGINAL	NO	NO	NO	NO
+40 dBm	OK	OK	OK	OK	MARGINAL	NO	NO	NO
+30 dBm	OK	OK	OK	OK	OK	MARGINAL	MARGINAL	NO
+20 dBm	OK	OK	OK	OK	OK	OK	OK	MARGINAL
+10 dBm	OK	OK	OK	OK	OK	OK	OK	OK

Packaging for Power Handling

Package Type	Lp	Cp	Rs	Thermal Performance (θ_p)	Cost	Max Frequency (GHz)	Hermetic	Comments
Ceramic	Excellent	Excellent	Excellent	Excellent	High	18	Yes	Most products available
MELF	Good	Fair	Excellent	Very Good	Moderate	2	Yes	Only select PIN diodes available
MMSM	Very Good	Very Good	Good	Good	Low	8	No	Only select PINs and varactors
Giga Mite	Good	Very Good	Good	Very Good	Low	6	No	Only select PINs, varactors and Schottkys
EPSM	Good	Good	Good	Good	Moderate	6	No	Most products available
Stripline	Good	Good	Good	Fair	Moderate	8	Yes or No	Most products available
Glass Axial	Fair	Good	Good	Poor	Moderate	1.5	Yes	Only select PINs, varactors, and Schottkys
Plastic	Poor	Fair	Fair	Poor	Low	2	No	Only select PINs, varactors, and Schottkys

PIN Diodes

GC4200 Series/Small Signal/High Speed Switching Chip Electrical Specifications: T_A 25°C

MODEL NUMBER	BREAKDOWN VOLTAGE V_B @ 10 μ A (MIN)(V)	JUNCTION CAPACITANCE ¹ C_J @-10V (MAX) (pF)	SERIES RESISTANCE ² (R_s @20mA, 1 GHz) (MAX) (Ohms)	CARRIER LIFETIME T_L ($I_R=6$ mA, $I_F=10$ mA) (Typ) (nS)	THERMAL RESISTANCE (MAX) (°C/W)
GC4270	70	0.06	1.5	100	80
GC4271	70	0.1	1	100	70
GC4272	70	0.2	0.8	100	70
GC4273	70	0.3	0.7	100	60
GC4274	70	0.4	0.6	100	50
GC4275	70	0.5	0.5	100	40
GC4210	100	0.06	1.5	200	80
GC4211	100	0.1	1	200	70
GC4212	100	0.2	0.75	200	70
GC4213	100	0.3	0.6	200	60
GC4214	100	0.4	0.5	200	50
GC4215	100	0.5	0.35	200	40
GC4220	250	0.06	2.5	500	80
GC4221	250	0.1	2	500	70
GC4222	250	0.2	1.5	500	70
GC4223	250	0.3	1	500	60
GC4224	250	0.4	0.8	500	50
GC4225	250	0.5	0.6	500	40

GC4400 Series/Large Signal Switching/Attenuator Chip Electrical Specifications: T_A 25°C

MODEL NUMBER	BREAKDOWN VOLTAGE V_B @ 10 μ A (MIN)(V)	JUNCTION CAPACITANCE ¹ C_J @-50V (MAX) (pF)	SERIES RESISTANCE ² (R_s @100mA, 100 MHz) (MAX) (Ohms)	CARRIER LIFETIME T_L ($I_R=6$ mA, $I_F=10$ mA) (Typ) (μ S)	THERMAL RESISTANCE (MAX) (°C/W)
GC4410	100	0.1	0.6	0.4	40
GC4411	100	0.25	0.5	0.6	25
GC4412	100	0.5	0.4	0.8	20
GC4413	100	0.75	0.3	1.2	10
GC4430	300	0.1	1.5	0.6	40
GC4431	300	0.25	1.2	1.2	30
GC4432	300	0.5	1	1.5	20
GC4433	300	0.75	0.8	2	10
GC4490	750	0.1	1.5	1	30
GC4491	750	0.25	1.2	2	25
GC4492	750	0.5	1	3	20
GC4493	750	0.75	0.8	4	10
GC4494	750	1.3	0.35	5	7
GC4495	750	2.5	0.3	6	5

Notes:

1. Capacitance is measured at 1 MHz and -10 volts.
2. Resistance is measured using transmission loss techniques.
3. These devices are not available in all case styles. Please consult the factory for specific package styles offered

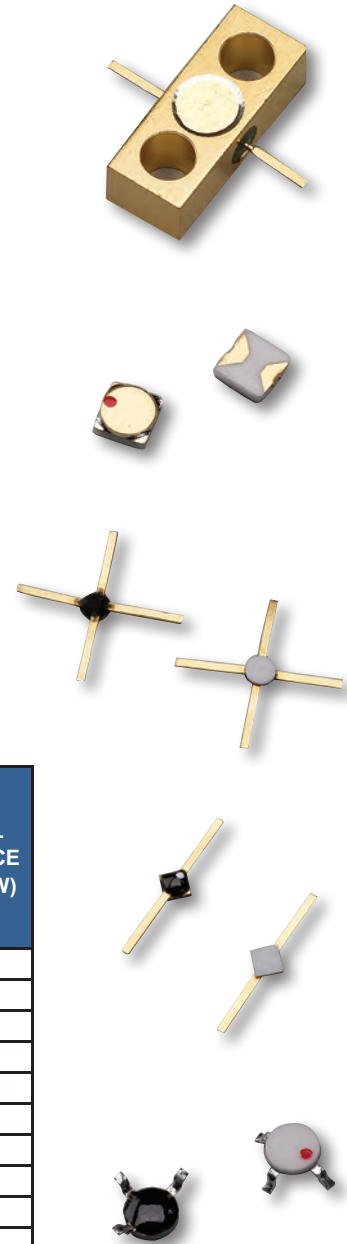

PIN Diodes

GC4700 Series/Large Signal Switching/Attenuator Chip Electrical Specifications: T_A 25°C

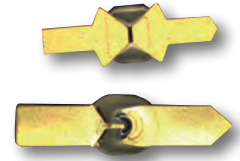

MODEL NUMBER	BREAKDOWN VOLTAGE V _B @ 10uA (MIN)(V)	JUNCTION CAPACITANCE C _J @ 0V (Typ) (pF)	JUNCTION CAPACITANCE C _J @ -6V (Max) (pF)	JUNCTION CAPACITANCE C _J @ -50V (Max) (pF)	SERIES RESISTANCE ² (R _s @10mA, 1 GHz) (MAX) (Ohms)	CARRIER LIFETIME T _L (I _R =6 mA, I _F =10 mA) (T _{VP}) (uS)	THERMAL RESISTANCE (Typ) (°C/W)
GC4701	20	0.2	0.15	1.5	1.5	5	20
GC4702	20	0.5	0.3	1.2	1.2	10	12
GC4711	45	0.2	0.15	1.5	1.5	10	15
GC4712	45	0.5	0.3	1.2	1.2	15	10
GC4713	45	0.7	0.5	1	1	20	6
GC4721	120	0.2	0.15	1.5	1.5	50	1.2
GC4722	120	0.6	0.3	1	1	50	0.5
GC4723	120	0.8	0.5	0.5	0.5	100	0.3
GC4731	15	0.12	0.1	20	20	5	30
GC4732	15	0.2	0.15	1.5	1.5	5	20
GC4741	30	0.12	0.1	2	2	7	20
GC4742	30	0.2	0.15	1.5	1.5	7	15
GC4750 ³	250			0.25	3.0 @50mA	300	4

Notes: 1. Pulse length 1 microsecond. 2. As measure in style 30 package. 3. Supplied as -002 style, dual mesa.

GC4800 Series/Planar Beam Lead PINs Electrical Specifications: T_A 25°C

MODEL NUMBER	BREAKDOWN VOLTAGE V _B @ 10uA (MIN)(V)	CAPACITANCE ¹ C _T @-10V (Typ/Max) (pF)	CAPACITANCE ¹ C _T @-50V (Typ/Max) (pF)	SERIES RESISTANCE ¹ (R _s @20mA) (Typ/Max) (Ohms)	SERIES RESISTANCE ¹ (R _s @50mA) (Typ/Max) (Ohms)	CARRIER LIFETIME T _L (I _R =6 mA, I _F =10 mA) (T _{VP}) (uS)	SWITCHING SPEED T _S (Max) (nS)
GC4800A - 14	80	0.016 / 0.020	--	4.5 / 6.5		150	30
GC4801 - 14	80	0.020	0.018 / 0.020		3.5 / 4.0	150	30
GC4802 - 14	100		0.060 / 0.070		2.2 / 3.0	150	30
GC4810 - 16	150		0.025 / 0.035		3.0 / 4.0	300	50

Notes: 1. RS and CT are determined using Loss and Isolation measurements at F = 2.2 GHz.

GC4900 Series/Mesa Beam Lead PINs Electrical Specifications: T_A 25°C

MODEL NUMBER	BREAKDOWN VOLTAGE V _B @ 10uA (MIN)(V)	CAPACITANCE C _T @-10V (Typ/Max) (pF)	DC PERFORMANCE			RF PERFORMANCE TYP ¹	
			SERIES RESISTANCE (R _s @10mA, F=2.2GHz) (Max) (Ohms)	SERIES RESISTANCE (R _s @50mA, F=2.2GHz) (Max) (Ohms)	CARRIER LIFETIME T _L (I _R =6 mA, I _F =10 mA) (T _{VP}) (uS)	Isol (dB) @VR=10V F=2.2 GHz	IL (dB) IF=10mA F=2.2 GHz
GC4902 - 12	100	0.025		3	80		
GC4903 - 12	100	0.030		2.5	80		
GC4941 - 12	50	0.060	1.5		50	22	0.14
GC4942 - 12	50	0.040	2		45	26	0.17
GC4943 - 12	50	0.030	3		40	27.5	0.27
GC4944 - 12	50	0.025	3.5		35	29	0.3
GC4945 - 12	50	0.022	5.5		40	30.5	0.45
GC4946 - 12	50	0.020	6.5		40	32	0.51

Notes: 1. Insertion loss and Isolation are test at F = 2.2 GHz using transmission loss techniques.

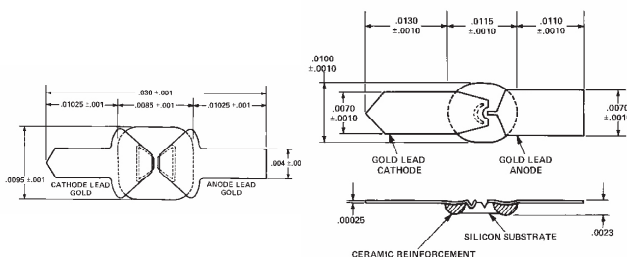

PIN Diodes



SM Series Ceramic MELF PINs

Electrical Specifications: T_A 25°C

PART NUMBER	CASE STYLE SUGGESTED	BREAKDOWN VOLTAGE V_B @ 10 μ A (MIN)(V)	TOTAL CAPACITANCE ¹ C_T @ -50V (Max) (pF)	SERIES RESISTANCE ² (R_s @100mA) (MAX) (Ohms)	SERIES RESISTANCE ² (R_s @200mA) (MAX) (Ohms)	T_L ($I_R=6$ mA $I_F=10$ mA) (Typ) (μ S)	THERMAL RESISTANCE (Typ) ($^{\circ}$ C/W)
SM0502	M1	500	0.50	0.70	0.55	1.0	35
SM0504	M1	500	0.60	0.60	0.45	1.5	20
SM0508	M1	500	0.90	0.40	0.25	2.0	15
SM0509	M1	500	1.20	0.35	0.20	2.5	15
SM0511	M1	500	1.25	0.30	0.15	3.0	15
SM0512	M1	500	1.50	0.25	0.12	3.5	15
SM0812	M1	700	1.30	0.40	0.25	4.0	15
SM1001	M1	700	1.30	0.35	0.20	4.5	15
SM1002	M1	50	1.20	.75 @ 50mA	0.20	4.0	15
SM1003	M1	35	1.2 @ 20V	.50 @ 10mA	0.10	0.6	25

Notes: 1. Total Capacitance measured at F=1 MHz. 2. Series Resistance measured at F=100 MHz.

RoHS and MRI Models

Base Model	RoHS Compliant PN	Non-Mag. / RoHS PN
SM0502 – M1	SMX0502 – M1	SMX0502MR – M1
SM0504 – M1	SMX0504 – M1	SMX0504MR – M1
SM0508 – M1	SMX0508 – M1	SMX0508MR – M1
SM0509 – M1	SMX0509 – M1	SMX0509MR – M1
SM0511 – M1	SMX0511 – M1	SMX0511MR – M1
SM0512 – M1	SMX0512 – M1	SMX0512MR – M1
SM1002 – M1	SMX1002 – M1	SMX1002MR – M1
SM1003 – M1	SMX1003 – M1	SMX1003MR – M1

+ 'Non Magnetic' refers to any products that are designed with low and ultra low magnetic materials for use in MRI systems

++ RoHS versions are supplied with a matte tin finish.

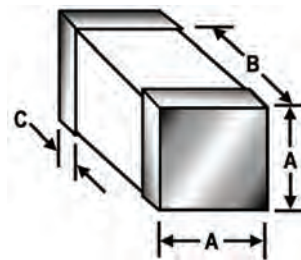

DIM	M1	
	INCHES	
	MIN	MAX
A	0.080	0.095
B	0.115	0.135
C	0.008	0.030

Monolithic Microwave Surface Mount (MMSM) PIN Diodes

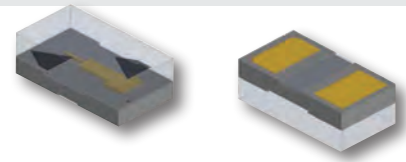

This series of surface mount PIN diodes utilize new and unique monolithic MMSM technology. The technology is a package/device integration accomplished at the wafer fabrication level. Since the cathode and anode interconnections utilize precision photolithographic techniques rather than wire bonds, parasitic package inductance is tightly controlled. The package parasitics provide smooth non-resonant functionality through 12GHz.

Key Features

- Tape and Reeled for Automatic Assembly
- Low Series Inductance (<0.2nH typical)
- Low Parasitic Capacitance (0.06 pf typical)
- Meets All Commercial Qualification Requirements
- 0204 Outline
- Low thermal resistance

Applications Benefits

- 2.4 GHz PCS communications
- 5.7 GHz Wireless LANS
- Solid State Switches, Attenuators, Limiters
- Phase Shifters
- Widest bandwidth of any commercial surface mounted devices
- Ultra tight parametric distribution

Electrical Specifications: T_A 25°C

PART NUMBER	OUTLINE	BREAKDOWN VOLTAGE V _B @ 10uA (Min)(V)	TOTAL CAPACITANCE ¹ C _T @ -10V (Max) (pF)	SERIES RESISTANCE ² (R _s @0.01mA) (Typ) (Ohms)	SERIES RESISTANCE ² (R _s @1mA) (Ohms)	SERIES RESISTANCE ² (R _s @10mA) (Max) (Ohms)	T _L (I _R =6 mA I _F =10 mA) (Typ) (nS)	APPLICATION
MPP4201	206	70	0.2				150	Attenuator
MPP4202	206	50	0.15				50	MRI
MPP4203	206	50	0.1				50	High Isolation Switch
MPP4204	206	25	0.15			2	20	High Speed Switch
MPP4205	206	70	0.15	250	7-16	5	150	Attenuator
MPP4206	206	200	0.15		5 (Typ)	2.5	500	Attenuator/Switch
MPL4700	206	25	0.15		2	2.0 ^A	20	Receiver Protection
MPL4701	206	15				2.5 ^A	10	Receiver Protection
MPL4702	406	50 ^B			12	2	30	Anti-parallel Pair MRI Surface Coil Detune

Notes:

1. Total Capacitance measured at F=1 MHz.
2. Series Resistance measured at F=100 MHz.

MRI Applications Matrix



Volume/Bird Cage Coils—Switching Diodes

(End ring resonant/anti-resonant Switching Diodes)

Model #	VBR	CT(pF)	Wi (um)	$\tau(\mu\text{s})$	$R_s(\Omega)^1$	@IF(mA)	Application
HUM2015	1500	3.5	275	20	0.1	500	Switching
HUM2020	2000	3.5	275	20	0.1	500	Switching

Surface Coil—Receive Array PIN Diodes

(Loop Array or Strip Array 4 Channels and NX4 Channels)

Model #	VBR	CT(pF)	Wi (um)	$\tau(\mu\text{s})$	$R_s(\Omega)^1$	@IF(mA)	Application
UMX5601	100	2.5	175	5	0.75	50	ULTRA-Low Magnetic Receive Array
UM7201	100	2.2	50	1.5	0.25	100	Receive Array
UM9701	100	1.8	50	1.5	0.8	10	Receive Array
UM9995	100	1.2	100	2	0.6	100	ULTRA-Low Magnetic Receive Array
UMX5101	100	1.2	125	2.5	0.8	50	ULTRA-Low Magnetic Receive Array
UM9989AP ³	75	1.2 ²	--	0.004	2	100	Low Magnetic Receive Array
MPL4702 ³	50	1.2 ²	--	0.03	2	10	Low Magnetic Receive Array

Transmit/Receiver Control Boards

Model #	VBR	CT(pF)	Wi (um)	$\tau(\mu\text{s})$	$R_s(\Omega)^1$	@IF(mA)	Application
UM4001	100	3	175	5	0.25	500	T/R Control
UM4301	100	2.2	325	6	1.5	100	T/R Control
UM7301	100	0.7	325	4	3	100	T/R Control
SMX0512MR	500	1.5	50	3.5	0.35	100	T/R Control
UM7101	100	1.2	100	2	0.6	100	T/R Control
UM6201	100	1.1	50	0.6	0.4	100	T/R Control
UM9415	50	3	175	5	0.75	50	T/R Control

Receiver Protection Circuits

Model #	VBR	CT(pF)	Wi (um)	$\tau(\mu\text{s})$	$R_s(\Omega)^1$	@IF(mA)	Application
UM9989	75	1.2	--	0.006	2	100	Receiver Protection
UM1089	75	1.5	--	0.015	0.8	100	Receiver Protection
UM7201	100	2.2	50	1.5	0.25	100	Receiver Protection
SMX0509MR	500	1.2	50	2.5	0.2	200	Receiver Protection
MPP4204	25	0.15	--	0.02	2	10	Receiver Protection
MPL4702 ³	50	1.22	--	0.03	2	10	Receiver Protection
UM9415	50	3	175	5	0.75	50	Receiver Protection

Notes:

1. Series Resistance (RS) is measured at 100MHz.
2. Nominal Ct per Diode.
3. Anti-parallel Pairs

Power PIN Diodes

Power PIN Diodes for Switching and Attenuation

Featuring fast switching products through High Power / Low IM products for TR switching control

Category	CT@100V (Typ) (pF)	CT@50V (Typ) (pF)	R _p @100V (Min) (kOhms)	R _p @30V (Min) (kOhms)	TL (Min/Typ) (uS)	Rs@100 mA (Max) (Ohms)	RoHS Available	Low Mag	V _b (Min) (V)	PN
HIGH POWER PIN DIODE Up to 2000V	3.4		200	100	10 / 30		Yes		200 500 1000 2000	HUM2002 HUM2005 HUM2010 HUM2020
ULTRA LOW MAGNETING MED Power Switching Up to 1500V		2.6		100	5 / 15	0.5	Yes	Yes	100 500 1000 1500	UMX5601 UMX5605 UMX5610 UMX5515
SWITCHING / ATTENUATION MED Power Up to 1000V		2.2	200		6	1.5	Yes		100 200 600 1000	UM4301 UM4302 UM4306 UM4310
SWITCHING / ATTENUATION MED Power Up to 1000V		0.7	150		4	3	Yes		100 200 600 1000	UM7301 UM7302 UM7306 UM7310

Category	CT@0V (Typ) (pF)	CT@50V (Typ) (pF)	G @0V (Max) (uS)		TL (Typ) (nS)	Rs@100 mA (Typ) (Ohms)	RoHS Available	Low Mag	V _b (Min) (V)	PN
FAST TURN ON RECIEVER PROTECTION	1.2		40		6	2	Yes	Yes	75	UM9989
ANTI PARALLEL CONFIGURATION	2.4									UM9989AP
FAST TURN ON RECIEVER PROTECTION	1.5		40		15	0.8	Yes	Yes	75	UM9989

Category	CT@50V (Typ) (pF)	CT@100 V (Max) (pF)	R _p @0V (Min) (kOhms)	R _p @100V (Min) (kOhms)	TL (Typ) (uS)	Rs@100 mA (Typ) (Ohms)	RoHS Available	Low Mag	V _b (Min) (V)	PN
SURFACE MOUNT SWITCHING DIODE	0.75		5		4	0.5	Yes	Yes	75	UM9989
POWER PIN DIODES		0.4		300	2	2.2	Yes		100 200 600 1000	UM6601 UM6602 UM6606 UM6610



Schottky Diodes



Schottky Mixer Diodes

- Monolithic design for lowest parasitics
- Low Conversion Loss
- Suitable for applications to 26.5 GHz
- Excellent Noise Figure
- Can be supplied as monolithic or as packaged device
- Single, T & Quad configurations available
- RoHS Compliant

Freq. Range	PART NUMBER	Barrier	BREAKDOWN VOLTAGE V_B @ 10uA (Min)(V)	TOTAL CAPACITANCE C_T @ 0V (Max) (pF)	FORWARD VOLTAGE V_F @ 1mA (Max) (mV)	R_d @ $I_F = 5mA$ (Max) (Ohms)	NF ssbs Typ (dB)	Zif (Typ) (Ohms)
Ku-Ka	GC9901	ULTRA-LOW	2	0.10	310	18	6.5	140
X	GC9902			0.15	280	14	6	
C	GC9903			0.3	270	12	5.5	
S	GC9904			0.5	250	10	5.5	
Ku-Ka	GC9911	LOW	2	0.10	360	18	6.5	170
X	GC9912			0.15	350	14	6	
C	GC9913			0.3	340	12	5.5	
S	GC9914			0.5	330	10	5.5	
Ku-Ka	GC9921	LOW-MED	2	0.10	440	18	6.5	200
X	GC9922			0.15	430	14	6	
C	GC9923			0.3	410	12	5.5	
S	GC9924			0.5	390	10	5.5	
Ku-Ka	GC9931	MEDIUM	3	0.10	540	18	6.75	250
X	GC9932			0.15	530	14	6.25	
C	GC9933			0.3	520	12	5.75	
S	GC9934			0.5	500	10	5.5	
Ku-Ka	GC9941	HIGH	4	0.10	650	20	7	300
X	GC9942			0.15	630	16	6.25	
C	GC9943			0.3	620	12	5.75	
S	GC9944			0.5	600	10	5.75	

GaAs Schottky Barrier Diodes

Electrical Specifications: T_A 25°C

PART NUMBER	JUNCTION CAPACITANCE C_J @ 0V (Typ) (pF)	R_s (Max) (Ohms)	Typical LO Freq (GHz)	NF ssbs (Typ) (dB)	Zif (Typ) (Ohms)	V_B @ 10uA (Min)(V)
MS8001	0.12	6	9.375	5.6	250-500	5
MS8002	0.1	6	16	5.6	250-500	5
MS8003	0.07	6	24	6.5	250-500	5
MS8004	0.06	6	36	6.5	250-500	5

Flip Chip GaAs Schottky Barrier Diodes

Electrical Specifications: T_A 25°C

PART NUMBER	CAPACITANCE C_J @ 0V (Max) (pF)	R_s @10mA (Max) (Ohms)	V_F @10mA (mV)	Delta V_F (mV)	V_B @ 10uA (Min)(V)	Description
MS8150-P2613	0.08	7	650 - 750	na	3	Low R_s Flip Chip - Single
MS8151-P2613	0.06	9	600 - 800	na	3	Low C_t Flip Chip - Single
MS8250 - P2920	0.08	7	650 - 750	10	3	Low R_s Flip Chip - Antiparallel
MS8251 - P2920	0.06	9	600 - 800	10	3	Low C_t Flip Chip - Antiparallel



Enhanced Performance Surface Mount

EPISM PIN Diodes

For Switching and Attenuation

PART NUMBER	BREAKDOWN VOLTAGE V_B @ 10 μ A (Min)(V)	TOTAL CAPACITANCE C_T @ V_R (Max) (pF)	R_s @ I_F (Max) (Ohms)	T_L ($I_R=6$ mA $I_F=10$ mA) (Typ) (nS)	Application
LSP1000	35	0.28 @ 5V	2.5 @ 5mA	80 nS	Switch
LSP1002	100	0.32 @ 50V	4.0 @ 100mA	1500 nS	Attenuator
LSP1004	35	0.75 @ 20V	0.6 @ 10mA	150 nS	Switch
LSP1011	200	0.35 @ 50V	2.0 @ 100mA	2000 nS	Attenuator
LSP1012	20	0.35 @ 10V	1.8 Ohms @ 10mA	5 nS	Limitter

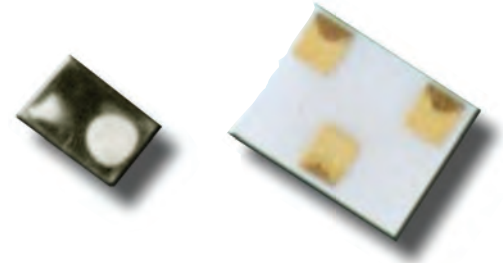

EPISM Super Hyperabrupt 12V

Varactors for Low Voltage VCOs

PART NUMBER	TOTAL CAPACITANCE C_T @ -1.0V (Min) (pF)	TOTAL CAPACITANCE C_T @ -2.5V (Min - Max) (pF)	TOTAL CAPACITANCE C_T @ -4V (Max) (pF)	TOTAL CAPACITANCE C_T @ -8V (Max) (pF)	Q (4V/50MHz) min
KV1913A	36 pF	18 - 27	12	6.20	400
KV1953A	26 pF	13 - 20	9	4.7	500
KV1923A	17 pF	8.5 - 13	6	3.2	600
KV1933A	13 pF	6.5 - 10	4.5	2.7	750
KV1943A	9 pF	4.5 - 6.5	3	1.7	900
KV1963A	4 pF	2.0 - 3.0	1.5	1	1200
KV1973A	1.8 pF	1.1 - 1.5	0.8	0.55	1400
KV1983A	1.2 pF	0.8 - 1.1	0.6	0.45	1600
KV1993A	0.6 pF	0.5 - 0.8	0.4	0.35	1800

Microwave Hyperabrupt 22V Varactors

for Wide Bandwidth VCOs

PART NUMBER	TOTAL CAPACITANCE C_T @ 0V (Typ) (pF)	TOTAL CAPACITANCE C_T @ -4.0V (Min - Max) (pF)	TOTAL CAPACITANCE C_T @ -20V (Max) (pF)	Q (4V/50M Hz) min
KV2163	26 pF	8.75 - 10.80	2.5	400
KV2153	13.5 pF	4.45 - 5.50	1.3	600
KV2143	7 pF	2.65 - 3.30	0.9	700
KV2133	5 pF	1.75 - 2.20	0.7	850
KV2123	3 pF	1.30 - 1.65	0.55	1000
KV2113	2 pF	0.85 - 1.10	0.45	1200

Microwave Abrupt 30V Varactors

for Moderate Bandwidth, Low Noise VCOs

PART NUMBER	CT0/CT4 (min)	TOTAL CAPACITANCE C_T @ -4.0V (+ / - 10%) (pF)	CT4/CT30 (min)	Q (4V/50M Hz) min
GC1300	1.5	0.8	1.45	3900
GC1301	1.6	1.0	1.55	3800
GC1302	1.7	1.2	1.6	3700
GC1303	1.8	1.5	1.65	3600
GC1304	1.9	1.8	1.7	3500
GC1305	2	2.2	1.75	3400
GC1306	2	2.7	1.8	3300
GC1307	2.1	3.3	1.85	3100
GC1308	2.1	3.9	1.85	2700
GC1309	2.1	4.7	1.85	2600
GC1310	2.1	5.6	1.85	2500

Tuning Varactors

Varactor Category Performance Guide

Category	Model Number or Family	Max Voltage	Typical Ratio	Mod Sens Linearity	Relative Q or VCO Phase Noise
Abrupt GaAs	MV20000	15V	3:1	Poor; Exponential	Best
	MV21000	30V	4:1		
Abrupt Silicon	GC1200; GC1300; GC1500; 1N5400	30V	4:1		
	GC1600; 1N5400	45V	5:1		
	GC1700; 1N5100	60V	6:1		
Hyperabrupt GaAs	MV34000;	15V	6:1		
	MV30000; MV31000 MV32000	30V	11:1		
Hyperabrupt Silicon	KV2100; MPV2100	22V	11:1		
	GMV2100				
	KV2101				
	KV2201				
	KV2301				
	KV2401				
	KV2501				
	KV2601				
	KV2701				
	KV2801				
	KV3201; KV31S1 KV3901; KV38S2	30V	11:1	Good (Mid Range)	Very Good
Low "S" Linear FLTVARS	GC15000	22V	6:1	Excellent	Excellent
High "S" Linear FLTVARS	GC15000	22V	11:1	Excellent	Excellent
Silicon Super Hyperabrupts	KV1905A	12V	3:1	Good (Mid-Range)	Very Good
	KV1925A				
	KV1935A				
	KV1945A				
	KV1965A; MPV1965				
	KV1975A	12V	4:1	Good (Mid-Range)	Very Good
	KV1911A-KV1991A	12V	6:1	Good (Mid-Range)	Very Good
	KV1912A-KV1932A				
	KV1913A-KV1993A	12V	13:1	Good (Mid-Range)	Good
	KV1400				
	KV1500				
KV1600					
KV1700					
KV1800					

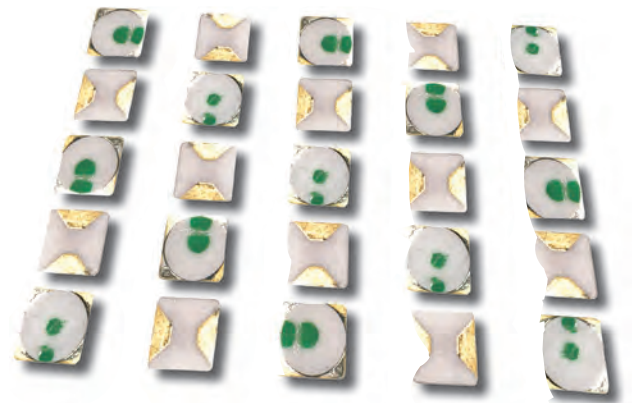

Tuning Varactors

Varactor Diode Selector Guide

Material	Silicon	Silicon	Silicon	Silicon	Silicon	Silicon	Silicon	GaAs	GaAs	GaAs	GaAs	GaAs	GaAs	GaAs
Freq. Band	Super Hyper Vb=12V P/N Series	Hjgh "S" Linear Vb=22V P/N	Low "S" Linear Vb=22V P/N	Hyper Vb=22V P/N Series	Abrupt Vb=30V Chip Ceramic Glass*	Abrupt Vb=30V EPSM	Abrupt Vb=30V SOT-23	Hyper Chips** VB=22V Low Gamma	Hyper Chips** VB=22V Medium Gamma	Hyper Chips** VB=22V High Gamma	Hyper Chips** VB=15V Very High Gamma	Hyper Flip Chip Vb=18V Medium Gamma	Abrupt Chips** Vb=15V	Abrupt Chips** Vb=30V
Microwave to 40 GHz								MV32001	MV30011	MV31011	MV34001		MV20001	MV21001
								MV32002	MV30012	MV31012	MV34002		MV20002	MV21002
								MV32003	MV30013	MV31013	MV34003		MV20003	MV21003
								MV32004	MV30014	MV31014	MV34004		MV20004	MV21004
								MV32005	MV30015	MV31015	MV34005		MV20005	MV21005
								MV32006	MV30016	MV31016	MV34006		MV20006	MV21016
								MV32007	MV30017	MV31017	MV34007		MV20007	MV21007
								MV32008	MV30018	MV31018	MV34008		MV20008	MV21008
								MV32009	MV30019	MV31019	MV34009		MV20009	MV21009
								MV32010	MV30020	MV31020	MV34010		MV20010	MV21010
Microwave to 18 GHz					GC1500A	GC1300				MV31021		MV39001		
				MPV2100	GC1500B	GC1301						MV39002		
	KV199x			KV211x	GC1500	GC1302				MV31022		MV39003		
	KV198x	GC15006	GC15001	KV212x	GC1501	GC1303								
	KV197x	GC15007	GC15002	KV213x	GC1502	GC1304				MV31023				
	KV196x	GC15008	GC15003	KV214x	GC1503	GC1305	GC1202							
	KV194x	GC15009	GC15004	KV215x	GC1504	GC1306	GC1203			MV31024				
	KV193x	GC15010	GC15005	KV216x	GC1505	GC1307	GC1204							
		GMV5007		GMV2114	GC1506	GC1308	GC1205			MV31025				
				GMV2134	GC1507	GC1309	GC1206							
			GMV2154	GMV1542	GC1310	GC1207			MV31026					
UHF to 1.0 GHz					GC1508			GC1208						
				KV2101	GC1509			GC1209						
				KV2101	GC1509			GC1210						
	KV192x	GC15011	GC15014	KV3201	GC1510	N/A		GC1211						
	KV195x	GC15012	GC15015	KV3901	GC1511			GC1212						
KV191x	GC15013	GC15016	KV2801	GC1512			GC1213							
				GC1513			GC1214							
VHF to 250 MHz				KV2001	1N5441			GC1215						
	KV1401	N/A	N/A	KV2201	1N5476	N/A		GC1216						
	KV1501			KV2301	thru			GC1217						
HF 1 - 50 MHz				KV2401										
	KV1601			KV2501										
	KV1701	N/A	N/A	KV2601	N/A	N/A	N/A							
	KV1801			KV2701										

MMSM Varactor Diodes

Monolithic Microwave Surface Mount (MMSM) Varactor Diodes

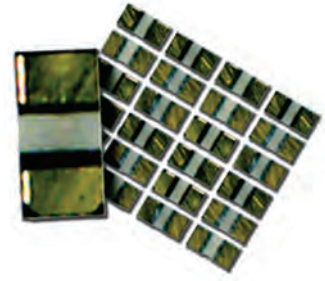

This series of surface mount PIN diodes utilize new and unique monolithic MMSM technology. The technology is a package/device integration accomplished at the wafer fabrication level. Since the cathode and anode interconnections utilize precision photolithographic techniques rather than wire bonds, parasitic package inductance is tightly controlled. The package parasitics provide smooth non-resonant functionality through 12GHz.

Key Features:

- Tape and Reeled for Automatic Assembly
- Low Series Inductance (<0.2nH typical)
- Low Parasitic Capacitance (0.06 pf typical)
- Meets All Commercial Qualification Requirements
- 0204 Outline

Applications/Benefits

- 2.4 GHz PCS
- 5.7 GHz Wireless LANS
- VCO's (Voltage Controlled Oscillator)
- Tunable Filter
- Widest bandwidth of any commercial surface mounted devices
- Ultra tight parametric distribution

Electrical Specifications: T_A 25°C

PART NUMBER	V _b @10uA (Min) (V)	TOTAL CAPACITANCE C _T @ -1.0V (Min - Max) (pF)	RATIO C _T 1V/C _T 3V	RATIO C _T 1V/C _T 6V	Q (4V/50MHz) (Min)	Outline Dwg Number	Application
MPV1965	15	2.6-3.8	1.4-2.2	2.6-3.6	1500	206	Low Voltage VCO

PART NUMBER	V _b @10uA (Min) (V)	TOTAL CAPACITANCE C _T @ 0V (Typ) (pF)	TOTAL CAPACITANCE C _T @ -4.0V (Min - Max) (pF)	TOTAL CAPACITANCE C _T @ -20V (Min - Max) (pF)	Q (4V/50MHz) (Min)	Outline Dwg Number	Application
MPV2100	22	3.25	0.9-1.5	0.2-0.5	1500	206	Wide Bandwidth VCO

GaAs Varactor Diodes

Microsemi's GaAs varactors are available as Abrupt Junction and Hyperabrupt Junction. Our computer controlled epitaxy provide the optimal C-V characteristics for your application. GaAs varactors feature extremely high Q and lowest phase noise for critical applications/

Electrical Specifications: T_A 25°C

15 Volt Abrupt Junction Varactors, Gamma = 0.6					30 Volt Abrupt Junction Varactors, Gamma = 0.6				
PART NUMBER	TOTAL CAPACITANCE C _T @ -4.0V (+/- 10%) (pF)	RATIO C _T 0V/C _T V _{BR}	V _b @10 uA (Min) (V)	Q (4V/50MHz) (Min)	PART NUMBER	TOTAL CAPACITANCE C _T @ -4.0V (+/- 10%) (pF)	RATIO C _T 0V/C _T V _{BR}	V _b @10 uA (Min) (V)	Q (4V/50MHz) (Min)
MV20001	0.3	2.4	15	8000	MV21001	0.3	2.8	30	8000
MV20002	0.4	2.6	15	7500	MV21002	0.4	3.1	30	7500
MV20003	0.5	2.8	15	7000	MV21003	0.5	3.4	30	7000
MV20004	0.6	2.9	15	6500	MV21004	0.6	3.6	30	6500
MV20005	0.8	3	15	6000	MV21005	0.8	3.8	30	6000
MV20006	1	3.1	15	5700	MV21006	1	4	30	5700
MV20007	1.2	3.2	15	5000	MV21007	1.2	4.2	30	5000
MV20008	1.5	3.3	15	5000	MV21008	1.5	4.3	30	5000
MV20009	1.8	3.4	15	5000	MV21009	1.8	4.5	30	5000
MV20010	2.2	3.4	15	4000	MV21010	2.2	4.6	30	4000

Electrical Specifications: T_A 25°C

15 Volt Hyperabrupt Varactors - Gamma = 1.00					22 Volt Hyperabrupt Varactors - Gamma = 1.00				
PART NUMBER	TOTAL CAPACITANCE C _T @ -4.0V (+/- 10%) (pF)	RATIO C _T 2V/C _T 12V	V _b @10 uA (Min) (V)	Q (4V/50MHz) (Min)	PART NUMBER	TOTAL CAPACITANCE C _T @ -4.0V (+/- 10%) (pF)	RATIO C _T 2V/C _T 12V	V _b @10 uA (Min) (V)	Q (4V/50MHz) (Min)
MV30001	0.6	2.5	15	4000	MV30011	0.6	3.1	22	4000
MV30002	1	3.1	15	3000	MV30012	1	4.1	22	3000
MV30003	1.2	3.2	15	3000	MV30013	1.2	4.3	22	3000
MV30004	1.5	3.4	15	3000	MV30014	1.5	4.8	22	3000
MV30005	1.8	3.5	15	3000	MV30015	1.8	5	22	3000
MV30006	2.2	3.6	15	3000	MV30016	2.2	5.3	22	3000
MV30007	2.5	3.7	15	2500	MV30017	2.5	5.5	22	2500
MV30008	3	3.8	15	2500	MV30018	3	5.7	22	2500
MV30009	3.6	3.8	15	2000	MV30019	3.6	5.9	22	2000
MV30010	4.5	3.9	15	1500	MV30020	4.5	6.1	22	1500

Electrical Specifications: T_A 25°C

15 Volt Hyperabrupt Varactors - Gamma = 1.25					22 Volt Hyperabrupt Varactors - Gamma = 1.25				
PART NUMBER	TOTAL CAPACITANCE C _T @ -4.0V (+/- 10%) (pF)	RATIO C _T 2V/C _T 12V	V _b @10 uA (Min) (V)	Q (4V/50MHz) (Min)	PART NUMBER	TOTAL CAPACITANCE C _T @ -4.0V (+/- 10%) (pF)	RATIO C _T 2V/C _T 12V	V _b @10 uA (Min) (V)	Q (4V/50MHz) (Min)
MV31001	0.6	3	15	4000	MV31011	0.5	3.2	22	4000
MV31002	1	3.7	15	3000	MV31012	0.7	4	22	4000
MV31003	1.2	3.9	15	3000	MV31013	1	5	22	3000
MV31004	1.5	4.2	15	3000	MV31014	1.2	5.4	22	3000
MV31005	1.8	4.4	15	3000	MV31015	1.5	6	22	3000
MV31006	2.2	4.6	15	3000	MV31016	1.8	6.4	22	3000
MV31007	2.5	4.7	15	2000	MV31017	2	6.6	22	3000
MV31008	3	4.8	15	2000	MV31018	2.2	6.8	22	3000
MV31009	3.6	4.9	15	2000	MV31019	2.7	7.2	22	2000
MV31010	4.5	5	15	1500	MV31020	3.3	7.6	22	2000

Additional Gamma and Capacitance values are available. Consult the factory or www.microsemi.com.

Gunn Diodes

MG1001 - MG1060 Cathode Heat Sink

- 5.9-95GHz, CW designs to 500mW and pulsed designs to 10W
- High reliability, low phase noise, and low 1/f noise
- Transmitters and receivers, beacons, radars, radiometers, and instrumentation
- Motion detectors and automotive collision avoidance



Discrete Frequency: Cathode Ground (CW EPI-Down)								
Minimum Power (mW)	C (5.4-6.9) GHz	X (8.0-12.4) GHz	Ku (12.4-18.0) GHz	K (18.0-26.5) GHz	Ka (18-26.5) GHz	U (40.0-60.0) GHz	V (60.5-85) GHz	W (85.0-95.0) GHz
10							MG1036-M16 V _{OP} = 4.5V @ I _{OP} = 900mA	MG1024-M16 V _{OP} = 4.5V @ I _{OP} = 1100mA
20								MG1025-16 V _{OP} = 4.5V @ I _{OP} = 1000mA
50	MG1001-M11 V _{OP} = 12V @ I _{OP} = 400mA	MG1005-M11 V _{OP} = 10V @ I _{OP} = 400mA	MG1009-M11 V _{OP} = 8V @ I _{OP} = 500mA	MG1013-M16/83B V _{OP} = 6V @ I _{OP} = 600mA	MG1017-M16 V _{OP} = 4.5V @ I _{OP} = 700mA	MG1021-M16 V _{OP} = 4V @ I _{OP} = 800mA	MG1037-M16 V _{OP} = 5V @ I _{OP} = 1100mA	MG1038-M16 V _{OP} = 5V @ I _{OP} = 1200mA
100	MG1002-M11 V _{OP} = 12V @ I _{OP} = 600mA	MG1006-M11 V _{OP} = 10V @ I _{OP} = 700mA	MG1010-M11 V _{OP} = 8V @ I _{OP} = 800mA	MG1014-M16/83B V _{OP} = 6V @ I _{OP} = 1000mA	MG1018-M16 V _{OP} = 4.5V @ I _{OP} = 1100mA	MG1022-M16 V _{OP} = 4V @ I _{OP} = 1200mA		
150							MG1023-M16 V _{OP} = 4V @ I _{OP} = 1600mA (40-50 GHz)	
200				MG1015-M16/83B V _{OP} = 6V @ I _{OP} = 1400mA	MG1019-M16 V _{OP} = 5V @ I _{OP} = 1400mA			
250	MG1003-42 V _{OP} = 12V @ I _{OP} = 1100mA	MG1007-42 V _{OP} = 10V @ I _{OP} = 1200mA	MG1011-42 V _{OP} = 8V @ I _{OP} = 1200mA		MG1020-M16 V _{OP} = 5.5V @ I _{OP} = 1600mA			
300					MG1039-M16 V _{OP} = 5.5V @ I _{OP} = 1700mA (26.5-35 GHz)			
350					MG1040-M16 V _{OP} = 5.5V @ I _{OP} = 1800mA (26.5-35 GHz)			
400				MG1016-83B V _{OP} = 6V @ I _{OP} = 1700mA (18.0-23 GHz)				
500	MG1004-42 V _{OP} = 12V @ I _{OP} = 1300mA	MG1008-42 V _{OP} = 10V @ I _{OP} = 1600mA	MG1012-42 V _{OP} = 8V @ I _{OP} = 1700mA					
5W Pulsed High Power (9.3GHz)		MG1034-42 V _{OP} = 35V @ I _{OP} = 8A						
10W Pulsed Stacked (9.3GHz)		MG1060-42 V _{OP} = 70V @ I _{OP} = 6A						

Polarity: Anode is the cap and Cathode is the heat-sink

MG1041-MG1058 Anode Heat Sink

- 9.5-25Ghz, pulsed and CW designs to 30mW
- High reliability, ultra low phase noise, and low 1/f noise
- Transmitters and receivers, beacons, radars, radiometers, and instrumentation
- Motion detectors and automotive collision avoidance



Discrete Frequency: Anode Ground (CW EPI-Up)		
Minimum	X	K
5		MG1054-30 V _{OP} = 5V @ I _{OP} = 200mA
10	MG1052-30 V _{OP} = 8V @ I _{OP} = 140mA	MG1058-30 V _{OP} = 5V @ I _{OP} = 300mA
20	MG1056-30 V _{OP} = 8V @ I _{OP} = 200mA	

Polarity: cathode is the cap and anode is the heat-sink

Discrete Frequency: Anode Ground (Pulsed EPI-Up)		
Minimum	X	K
5		MG1044-130 V _{OP} = 8V @ I _{OP} = 120mA
10	MG1041-30 V _{OP} = 9V @ I _{OP} = 110mA	MG1045-30 V _{OP} = 8V @ I _{OP} = 150mA
20	MG1042-30 V _{OP} = 9V @ I _{OP} = 140mA	MG1046-30 V _{OP} = 8V @ I _{OP} = 200mA
30	MG1043-30 V _{OP} = 10V @ I _{OP} = 180mA	

Polarity: cathode is the cap and anode is the heat-sink

Note: Operation over a narrow band around a specific center frequency. Other frequencies available upon request. Call factory. Operating voltage (VOP) typ. Operating current (IOP) max. Power measured with diode inserted in critically coupled cavity. Specifications @ 25°C. Specifications subject to change without notice.

Comb Generators

Model Number		Input	Output level			
		Frequency (MHz)	Up to 4.0 (GHz)	4.0 to 8.0 (GHz)	8.0 to 12.0 (GHz)	12.0 to 18.0 (GHz)
GG770140-01	GG770340-01	100	-10	-20	-	-
GG770140-02	GG770340-02	200	-5	-20	-	-
GG770140-03	GG770340-03	250	-5	-15	-20	-
GG770140-04	GG770340-04	500	0	-10	-20	-
GG770140-05	GG770340-05	1000	5	-5	-15	-15
GG770140-06	GG770340-06	1500	5	0	-10	-10
GG770140-07	GG770340-07	2000	5	0	-5	-10

Notes:

1. Minimum output power per line (dBm)
2. All specifications apply at 25°C with 0.5W incident RF power in a 50 ohm system (both source & load)
3. Performance above 12.0GHz is typical performance only.
4. Modular units require an external DC return at the output. Internal or RF decoupled DC returns are available on special order.
5. VSWR is specified at 2.0:1 max (for all model numbers).
6. Modular package style is 210003; Coaxial package style is 210020

Surface Mount Limiter

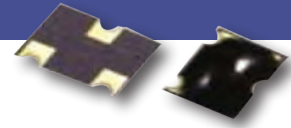

Model	Freq Range (MHz)	CW Power P_{CW} (W)	Peak Power ¹ P_P (W)	Ins. Loss ² IL(dB) T_{vp} .	VSWR ² Typ.	Flat Leakage ³ (dBm) Typ.			
						<= 1GHz	1.0-1.5GHz	1.5-1.85GHz	1.85-3.5GHz
GG77015-01	10 – 3000	4	20	0.5	1.5:1	15	18	20	23

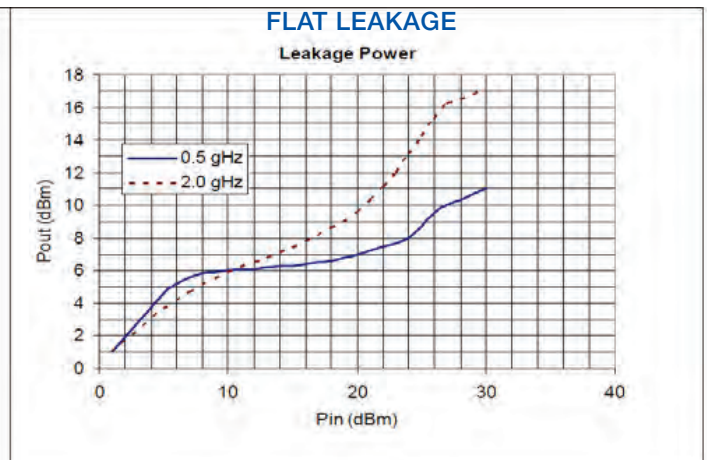
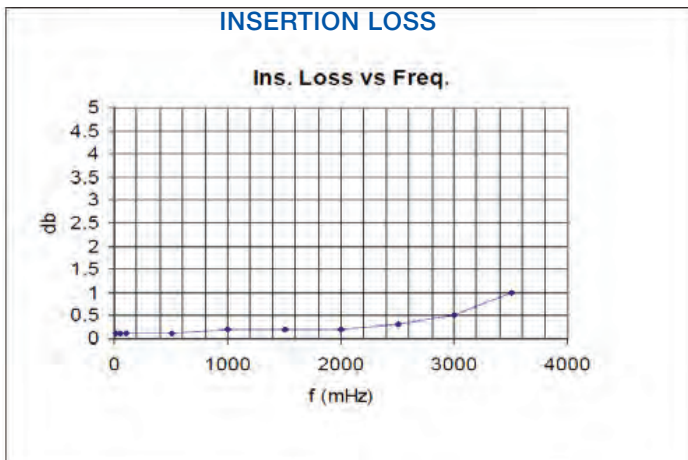

Notes:

1. Pulse Width = 1 usec, Duty Cycle = 0.001
2. P = -10dBm max
3. P = +30dBm, Pulse Width = 1 usec, Duty Cycle = 0.001
4. RF Power Handling is linearly derated from full power at +25°C to zero power at +150°C

PIN Diode Limiter Assemblies

Standard Broadband Limiter Modules

Frequency Range (GHz)	Insertion Loss (dB max)	VSWR (max)	Survival Peak	Power (Watts) CW	Flat Leakage (mW Max)	Model Number	Package Style
0.5 to 4.0	0.5	1.5:1	100	3	400	GG77012-01	210013
	0.7	1.5:1	200	3	200	GG77010-01	210001
	0.7	1.5:1	200	3	125	GG77011-01	210003
	0.8	1.5:1	1000	5	200	GG77013-01	210003
2.0 to 8.0	0.6	1.7:1	100	2	500	GG77012-02	210013
	0.7	1.7:1	200	2	125	GG77010-02	210001
	0.7	1.7:1	200	2	100	GG77011-02	210003
	1.2	1.7:1	1000	3	200	GG77013-02	210003
4.0 to 12.0	1	1.8:1	200	2	100	GG77010-03	210001
	1	1.8:1	200	2	60	GG77011-03	210003
	1.6	1.8:1	800	3	200	GG77013-03	210003
8.0 to 18.0	1.9	1.9:1	200	2	100	GG77010-04	210001
	1.9	1.9:1	200	2	60	GG77011-04	210003
	2.2	2.0:1	600	3	200	GG77013-04	210003
2.0 to 18.0	2	2.0:1	200	2	125	GG77010-05	210001
	2	2.0:1	200	2	100	GG77011-05	210003
	2.2	2.0:1	600	3	200	GG77013-05	210003

Low Leakage Broadband Limiter Modules

2.0 to 8.0	1.4	1.8:1	10	1	20	GG77014-01	210003
4.0 to 12.4	1.9	2.0:1	10	1	20	GG77014-02	210003
8.0 to 18.0	2.2	2.0:1	10	1	35	GG77014-03	210003

Standard Broadband Connectorized Limiters

Frequency Range (GHz)	Insertion Loss (dB max)	VSWR (max)	Survival Peak	Power (Watts) CW	Flat Leakage (mW Max)	Model Number	Package Style
0.5 to 4.0	0.6	1.5:1	200	3	200	GG77310-01	210019
	0.7	1.5:1	200	3	100	GG77311-01	210019
	0.9	1.5:1	1000	5	200	GG77313-01	210019
2.0 to 8.0	1	1.7:1	200	2	125	GG77310-02	210019
	1	1.7:1	200	2	100	GG77311-02	210019
	1.5	1.7:1	1000	3	200	GG77313-02	210019
4.0 to 12.0	1.5	1.8:1	200	2	100	GG77310-03	210019
	1.5	1.8:1	200	2	60	GG77311-03	210019
	2.1	1.8:1	800	3	200	GG77313-03	210019
8.0 to 18.0	2.2	1.9:1	200	2	100	GG77310-04	210019
	2.5	1.9:1	200	2	60	GG77311-04	210019
	2.5	2.0:1	600	3	200	GG77313-04	210019
2.0 to 18.0	2.2	2.0:1	200	2	125	GG77310-05	210019
	2.5	2.0:1	200	2	100	GG77311-05	210019
	2.5	2.0:1	600	3	200	GG77313-05	210019

Low Leakage Connectorized Limiters

2.0 to 8.0	1.4	1.8:1	10	1	20	GG77314-04	210019
4.0 to 12.4	2	2.0:1	10	1	20	GG77314-05	210019
8.0 to 18.0	2.5	2.0:1	10	1	35	GG77314-06	210019
2.0 to 8.0	1.4	1.8:1	10	1	20	GG77314-07	210032
4.0 to 12.4	2	2.0:1	10	1	20	GG77314-08	210032
8.0 to 18.0	2.5	2.0:1	10	1	35	GG77314-09	210032

Low Frequency Connectorized Limiters

0.01 to 0.1	0.7	1.5:1	100	1	200	GG77315-01	210019
0.1 to 0.5	0.7	1.5:1	100	1	200	GG77315-02	210019
0.5 to 1.0	1	1.5:1	100	1	200	GG77315-03	210019
0.01 to 0.1	0.7	1.5:1	100	1	200	GG77315-04	210093
0.1 to 0.5	0.7	1.5:1	100	1	200	GG77315-05	210093
0.5 to 1.0	1	1.5:1	100	1	200	GG77315-06	210093

Notes:

All low level parameters specified at -10 dBm input power

All limiter modules require an external DC return of 1.0 ohm or less except the GG77014-XX series, which requires external DC blocks at both ends. Model numbers GG77314-XX incorporate DC blocking capacitors and do not require either ground return or external DC blocks

Peak power ratings apply @ 1.0 μ sec pulse width and 0.001 duty cycle

Spike leakage is 0.2 ergs (max) based on the assumption that the pulse rise time of the high power pulse is greater than 20.0 nsec. Spike leakage for the low frequency limiters is specified at 0.1 ergs (max)

Recovery time (3 dB) for all units expect for the GG77014-XX, GG77314-XX and GG77315-XX series is 250nSec @ 100W pulsed input power. Series GG77314-XX and GG77014-XX recovers in 500nSec at rated pulsed power and series GG77315-XX recovers in 1.0 μ Sec at rated pulsed power

Limiting threshold (1 dB compression point) is 5mW (min) except for the GG77014-XX and GG77314-XX series which is 1.0mW (min)

Leakage levels are specified at rated peak power

Absorptive Switches

	Model Number	Frequency Range	Insertion Loss (dB max)	Isolation (dB min)	VSWR (max)	Outline
SPST	GG71420-01	0.5 – 4.0	1.7	55	1.5:1	210059
	GG71420-02	2.0 – 8.0	2.1	50	1.7:1	210059
	GG71420-03	4.0 – 12.4	2.4	45	1.8:1	210059
	GG71420-04	8.0 – 18.0	2.9	45	1.9:1	210059
	GG71420-05	2.0 – 18.0	2.9	45	2.0:1	210059
SP2T	GG72420-01	0.5 – 4.0	1.7	60	1.5:1	210047
	GG72420-02	2.0 – 8.0	2.1	55	1.7:1	210047
	GG72420-03	4.0 – 12.4	2.4	50	1.8:1	210047
	GG72420-04	8.0 – 18.0	2.9	45	1.9:1	210047
	GG72420-05	2.0 – 18.0	2.9	45	2.0:1	210047
SP3T	GG73420-01	0.5 – 4.0	1.7	60	1.5:1	210079
	GG73420-02	2.0 – 8.0	2.2	55	1.7:1	210079
	GG73420-03	4.0 – 12.4	2.5	50	1.8:1	210079
	GG73420-04	8.0 – 18.0	3	45	1.9:1	210079
	GG73420-05	2.0 – 18.0	3	45	2.0:1	210079
SP4T	GG74420-01	0.5 – 4.0	1.8	60	1.5:1	210049
	GG74420-02	2.0 – 8.0	2.3	55	1.7:1	210049
	GG74420-03	4.0 – 12.4	2.7	50	1.8:1	210049
	GG74420-04	8.0 – 18.0	3.2	45	1.9:1	210049
	GG74420-05	2.0 – 18.0	3.2	45	2.0:1	210049
SP5T	GG75420-01	0.5 – 4.0	1.6	45	1.5:1	210050
	GG75420-02	2.0 – 8.0	2.1	40	1.7:1	210050
	GG75420-03	4.0 – 12.4	2.6	40	1.8:1	210050
	GG75420-04	8.0 – 18.0	3.2	35	1.9:1	210050
	GG75420-05	2.0 – 18.0	3.2	35	2.0:1	210050
SP6T	GG75425-01	0.5 – 4.0	1.8	45	1.5:1	210051
	GG75425-02	2.0 – 8.0	2.2	40	1.7:1	210051
	GG75425-03	4.0 – 12.4	2.9	40	1.8:1	210051
	GG75425-04	8.0 – 18.0	3.6	35	1.9:1	210051
	GG75425-05	2.0 – 18.0	3.6	35	2.0:1	210051

Notes:

1. Required D.C. Bias: +5V and -8 to -15V
2. Switching Speed: 1usec maximum (50% TTL to 10/90% RF)
3. Only the switched arms are matched in the isolated state
4. The common arm, J1, is matched only when one path is in the loss state
5. DC blocks incorporated on all RF ports

Reflective Switches

	Model Number	Frequency Range	Insertion Loss (dB max)	Isolation (dB min)	VSWR (max)	Outline
SPST	GG71410-01	0.5 – 4.0	0.9	40	1.5:1	210059
	GG71410-02	2.0 – 8.0	1.3	50	1.7:1	210059
	GG71410-03	4.0 – 12.4	1.5	60	1.8:1	210059
	GG71410-04	8.0 – 18.0	1.7	55	1.9:1	210059
	GG71410-05	2.0 – 18.0	1.8	45	2.0:1	210059
SP2T	GG72430-01	0.5 – 4.0	1	60	1.5:1	210047
	GG72430-02	2.0 – 8.0	1.6	60	1.7:1	210047
	GG72430-03	4.0 – 12.4	2.2	60	1.8:1	210047
	GG72430-04	8.0 – 18.0	2.5	55	1.9:1	210047
	GG72430-05	2.0 – 18.0	2.5	55	2.0:1	210047
SP3T	GG73430-01	0.5 – 4.0	1.1	60	1.5:1	210079
	GG73430-02	2.0 – 8.0	1.8	60	1.7:1	210079
	GG73430-03	4.0 – 12.4	2.4	60	1.8:1	210079
	GG73430-04	8.0 – 18.0	2.7	55	1.9:1	210079
	GG73430-05	2.0 – 18.0	2.7	55	2.0:1	210079
SP4T	GG74430-01	0.5 – 4.0	1.2	60	1.5:1	210049
	GG74430-02	2.0 – 8.0	1.9	60	1.7:1	210049
	GG74430-03	4.0 – 12.4	2.4	60	1.8:1	210049
	GG74430-04	8.0 – 18.0	2.9	55	1.9:1	210049
	GG74430-05	2.0 – 18.0	2.9	55	2.0:1	210049
SP5T	GG75430-01	0.5 – 4.0	1.3	60	1.5:1	210050
	GG75430-02	2.0 – 8.0	2.1	55	1.7:1	210050
	GG75430-03	4.0 – 12.4	2.6	50	1.8:1	210050
	GG75430-04	8.0 – 18.0	3.3	45	1.9:1	210050
	GG75430-05	2.0 – 18.0	3.3	45	2.0:1	210050
SP6T	GG75435-01	0.5 – 4.0	1.5	60	1.5:1	210051
	GG75435-02	2.0 – 8.0	2.3	60	1.7:1	210051
	GG75435-03	4.0 – 12.4	2.8	60	1.8:1	210051
	GG75435-04	8.0 – 18.0	3.6	55	1.9:1	210051
	GG75435-05	2.0 – 18.0	3.6	55	2.0:1	210051

Notes:

1. Required D.C. Bias: +5V and -8 to -15V
2. Switching Speed: 50nsec maximum (50% TTL to 10/90% RF)
3. DC blocks incorporated on all RF ports

RF, Microwave & mmWave Diode Package Styles

Microsemi Lowell offers a wide variety of package styles to meet specific design requirements. Package selection is an important step in the design process. Designers need to be aware of parametric trades-offs for the various package styles. Some considerations are:

- Electrical Performance.
- Thermal Requirements
- Hermetic / Non Hermetic
- Taped and Reeled for automatic assembly
- Cost versus Performance.
- RoHS compliance
- Consult the factory for package selection assistance.

This catalog contains outlines for a selection of our standard package styles. However, we supply numerous variations of these packages to suit specific application needs. Microsemi can also work together with engineers to develop custom package solutions.

Most of our packages are supplied with a gold finish suitable for 'Lead Free' and Pb/Sn assembly techniques. Some RoHS compliant packages are supplied with a Matte Tin finish.

Microsemi offers:

- Hi-Rel Hermetic Packages
- High Frequency / Broadband (Through 40 Ghz) Discrete Packages
 - Chip, Beamlead & Flip Chip devices
- High Power Packages
 - Stud, ASM & SM Styles
- Low Cost High Volume Packages
 - SOT 23
 - Gigamite (GM1)
- Broadband performance, Economically Priced "MMSM"
 - Style 206
- EPSMTM (Enhance Performance Surface Mount)
 - Style 150, 250 and 450 Series
- RoHS Compliant Packaging

Diode Packages

Packages are RoHS Compliant unless specified

Style 34

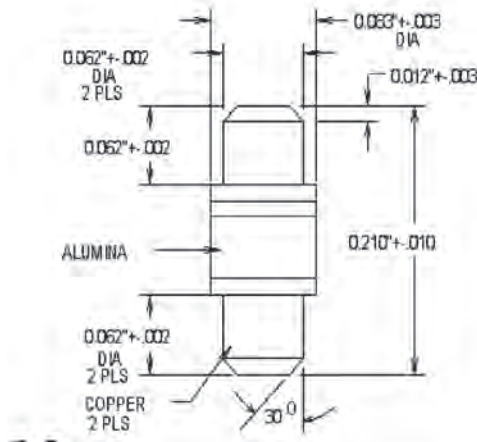

Style 79

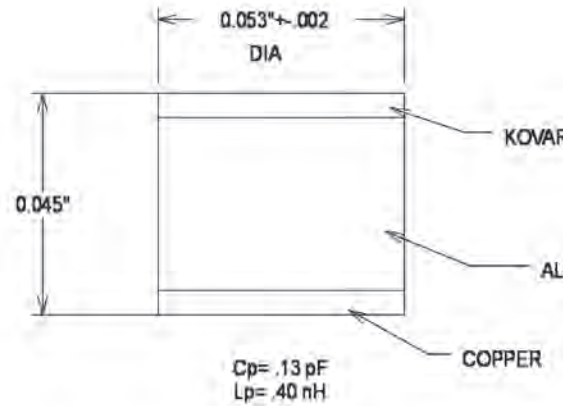

Style 115A

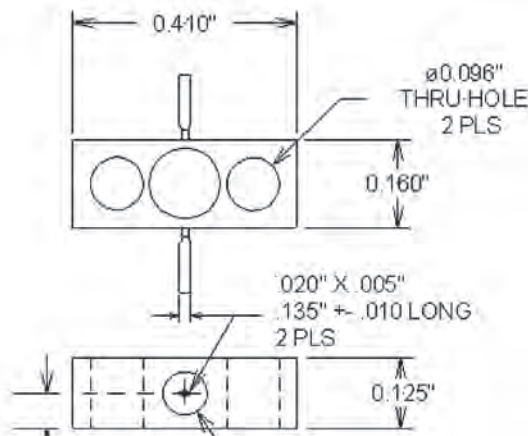

Style 127A

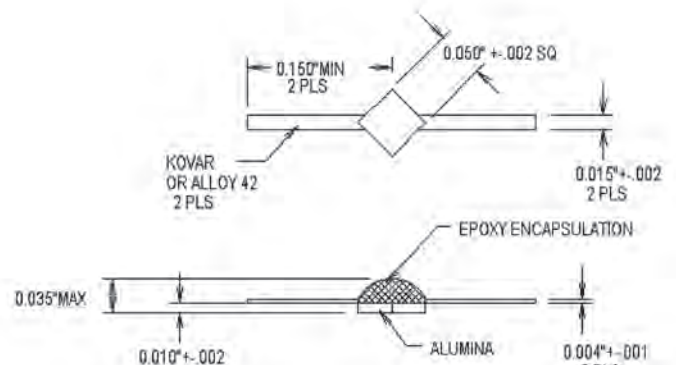

Style 127C

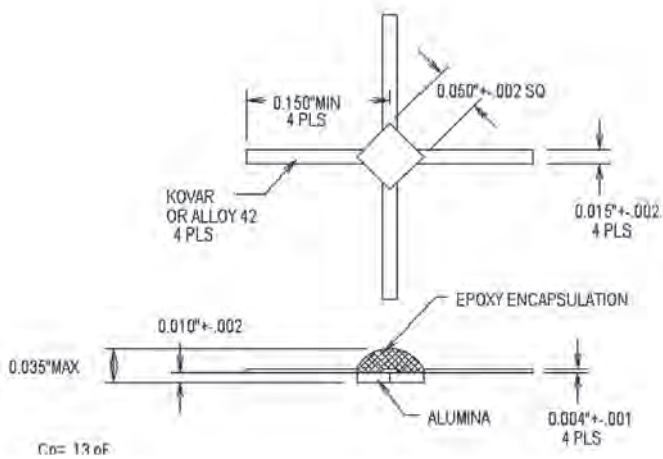

Style 149

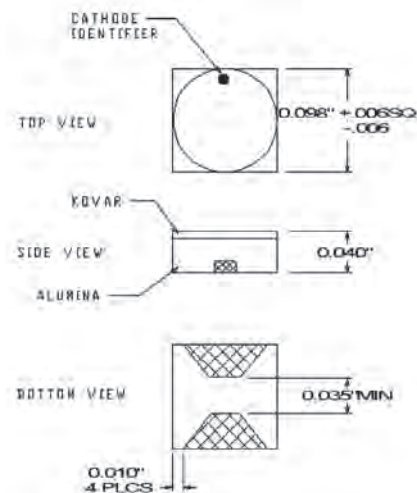

Diode Packages

Packages are RoHS Compliant unless specified

Style 174C

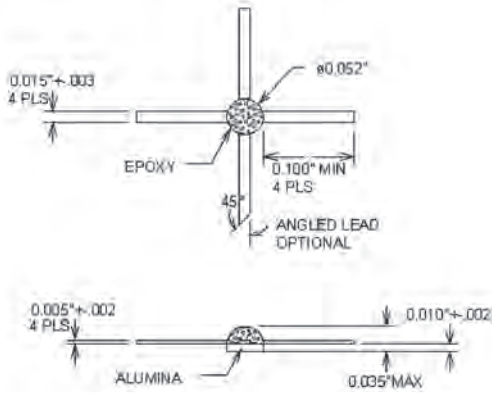

Style 206 (MMSM™)

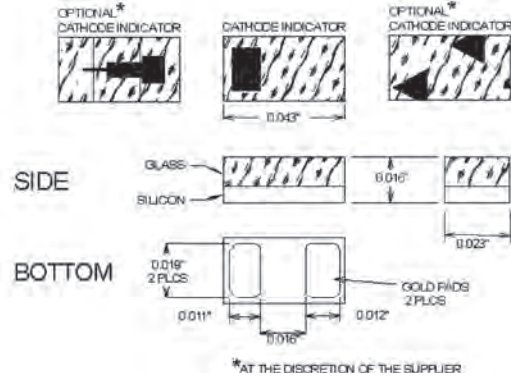

Style 250A - 250D

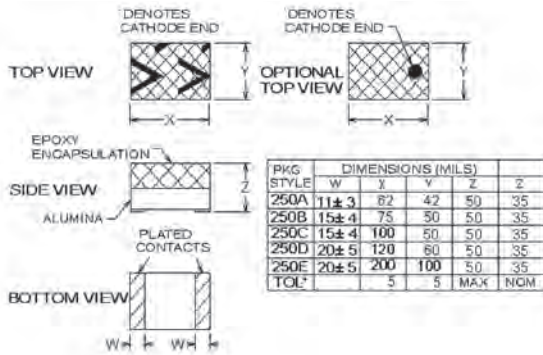

Style 454

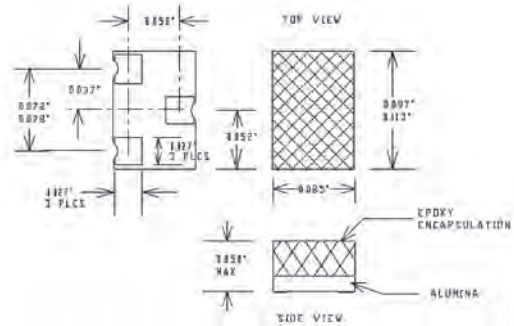

Style GM1

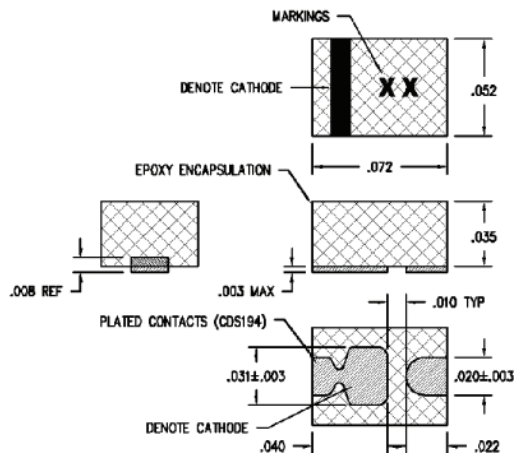

Style M1

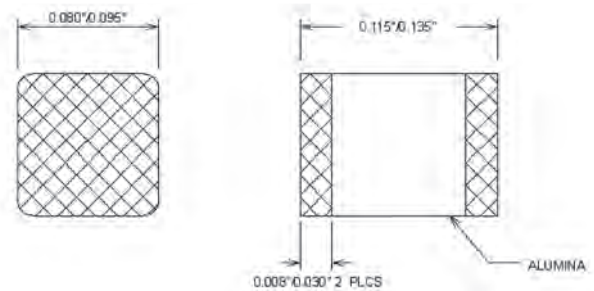

RF & Microwave Power Transistor Products



Among many diverse semiconductor business units, the Microsemi RF Integrated Solutions (RFIS) business unit was created in 2010 to best cohesively serve the RF, microwave, and millimeter wave products market. Along with diode and amplifier products were included RF and microwave power transistor products. The Microsemi RF and microwave power transistor products group specializes in supporting customers in the avionics, communications, and radar markets with full line-ups of products meeting the demanding requirements of transmitter amplifier systems, operating in airborne, ground based, missile, ship borne and space environments.

The Microsemi RFIS RF and microwave power transistor products line heritage spans more than 35 years and includes legacy CW and high pulsed power silicon bipolar junction transistor (BJT) devices and products originally designed by Acrian, GHz Technology, Advanced Power Technologies, Microwave Semiconductor Corporation, Motorola Semiconductor, Solid State Scientific, and SGS Thompson Microelectronics (ST). Whether an airborne IFF (Identify Friend or Foe), ground based primary surveillance radar, or for satellite borne communications or imaging, in the high reliability market most RF and microwave power amplifier transmitter systems are designed for a product life cycle of 15 to well beyond 25 years. Microsemi RF & microwave transistor product offerings are unique in supporting applications throughout the full life cycle and thereby have cultivated a long standing relationship with major system manufacturers worldwide. Our Santa Clara California silicon wafer foundry and Bend Oregon silicon and silicon carbide wafer foundries produce a very broad range of transistor die covering the frequencies from HF through 3.5 GHz, CW and Pulsed. Our facilities are fully ISO9001

certified and supply product for commercial, defense and space applications. Automated assembly and test equipment assures Microsemi customers consistent high quality products resulting in highest factory yields achievable which is passed on to Microsemi customers as the lowest cost of ownership. Combined with the use of the most advanced modern equipment for both manufacturing and test, is statistical process control (SPC) to achieve the best continual process improvement (CPI).

Our Mission and Goals

Our mission is to be the world leader in high power silicon and wide band gap (WBG) RF and microwave power transistors for avionics, communications and radar systems. With a sustained high research and development investment and a keen eye for accretive acquisitions, Microsemi will continue to be the market leader, always pushing the performance envelope by along with the best, and most efficient power amplifier driver transistors, continually introducing the highest power state of the art, most rugged and reliable RF, microwave, and millimeter wave transistor products. Whether a die, a packaged transistor, a 50Ω input and output plug and play transistor pallet, or a more integrated amplifier assembly, simply: The Microsemi goal is to provide the customer with products that meet all specified requirements over the life of the program. This ensures that our customers will always achieve the optimum system performance and lowest total cost of ownership.

GaN & SiC / Wide Band Gap

- Pulsed & CW products for primary and secondary radars & communications systems
- Wide band gap technologies allow higher voltage and higher junction temperature operation: more power - less space
- High Voltage GaN HEMT's on SiC for best thermal dissipation
- Wide band gap GaN on SiC HEMT (high electron mobility transistor) & SiC SIT (static induction transistor) semiconductor technologies
- VHF/UHF/L-Band SiC SIT devices deliver up to 2200W power output under 300us pulse width and 10% duty cycle pulsing
- GaN on SiC transistor devices deliver greater than 700W for L-Band pulsed avionics
- For pulsed radar GaN on SiC transistor devices deliver greater than 500W at L-Band, 500W at S-Band, & 150W at C-Band

Pulsed Devices Class AB	Pout Min (W)	Pin Max (W)	Gain Min (dB)	Vdd (V)	η Typ (%)	Idq Ave ¹ (mA)	Pulse Width (μ s)	Duty Cycle (%)	VSWR Load	θ_{jc} ($^{\circ}$ C/W)	Case Style	Part Number
VHF 150-160 MHz SiC SIT Common Gate	1250	160	9.5	125	60	500	300	10	10:1	0.15	55KT-2	0150SC-1250M
UHF 406-450 MHz SiC SIT Common Gate	100	11	10	125	50	30	300	10	10:1	2.5	55KT-FET	0405SC-100M
	500	55	10	125	50	100	300	10	10:1	0.3	55KT-FET	0405SC-500M
	1000	155	8.5	125	55	150	300	10	10:1	0.15	55ST-FET	0405SC-1250M
	1500	270	8	125	55	125	300	6	5:1	0.15	55ST-FET	0405SC-1500M
	2200	440	8	125	55	150	300	6	10:1	0.15	55TW-FET	0405SC-2200M
1030 MHz Mode-S ELM GaN on SiC HEMT	700	5	21.5	65	75	1000	2400**	6.4	3:1	0.25	55KR	1011GN-700ELM
1030/1090 MHz Mode-S ELM GaN on SiC HEMT Common Source	650	5	20.8	65	67	100	2400**	6.4	3:1	0.25	55KR	MDS-GN-650ELM
	750	14.1	17.2	50	68	100	2400**	6.4	3:1	0.24	55KR	MDSGN-750ELMV*
1030MHz Mode-S / TCAS / IFF GaN on SiC HEMT Common Source	1000	17.8	17.5	50	55	100	10	1	3:1	0.12	55KR	1011GN-1000V*
1025-1150 MHz Air DME GaN on SiC Class AB Common Source	700	12.6	19	50	60	100	20	6	3:1	0.21	55KR	DME-GN-700V
960-1215 MHz HD Data Link GaN on SiC HEMT Common Source	20	0.4	17	50	55	10	128	10	3:1	6.56	55KR	0912GN-20V*
	100	2.5	16	50	55	30	3000	30	3:1	1.07	55KR	0912GN-100LV*
	300	4	17.5	65	55	50	128	10	3:1	0.3	55KR	0912GN-300
	300	6.3	16.8	50	55	50	128	10	3:1	0.44	55KR	0912GN-300V*
	600	8	18	65	55	100	128	10	3:1	0.2	55KR	0912GN-600
	650	11.2	17.6	50	55	100	128	10	3:1	0.23	55KR	0912GN-650V*
L-Band 1200-1400 MHz GaN on SiC HEMT Common Source	20	0.4	17	50	50	20	300	10	5:1	5.39	55KR	1214GN-20V*
	100	2.5	16	50	55	30	3000	30	3:1	1.1	55KR	1214GN-100LV*
	280	6.3	16.7	50	60	50	200	20	3:1	0.57	55KR	1214GN-280LV*
	500	8	18	60	55	50	300	10	3:1	0.16	55KR	1214GN-500
	550	12	16.6	50	55	100	300	10	3:1	0.24	55KR	1214GN-550V*
S-Band 2700-2900 MHz GaN on SiC HEMT Common Source	150	10	11.76	50	50	30	100	10	5:1	0.92	55QP	2729GN-150V*
	150	8	12.7	60	50	30	100	10	5:1	1.1	55QP	2729GN-150
	270	16	12.7	50	55	60	100	10	3:1	0.38	55QP	2729GN-270V*
	270	12.6	13.3	60	55	60	100	10	3:1	0.6	55QP	2729GN-270
	400	28.2	11	65	50	80	100	10	3:1	0.24	55KR	2729GN-400
	500	36	11.4	50	50	100	100	10	3:1	0.18	55KR	2729GN-500V*
	500	35.5	11.5	65	54	100	100	10	3:1	0.2	55KR	2729GN-500
S-Band 2700-3100 MHz GaN on SiC HEMT Common Source	20	0.5	16	50	46	10	200	10	5:1	4.59	55QP	2731GN-20V*
	100	8	11	50	50	30	3000	30	3:1	1.02	55QP	2731GN-100LV*
	110	8	11.4	50	50	30	200	10	5:1	0.93	55QP	2731GN-110V*
	110	7.5	11.7	60	42	30	200	10	5:1	1.1	55QP	2731GN-110M
	200	12	12.2	60	42	500	200	10	3:1	0.6	55QP	2731GN-200M
	220	16	11.4	50	50	80	200	10	3:1	0.47	55QP	2731GN-220V*
	450	36	11	50	46	150	200	10	3:1	0.19	55KR	2731GN-450V*
S-Band 2700-3500 MHz GaN on SiC HEMT Common Source	35	2	12.4	60	40	15	300	10	5:1	2.4	55QP	2735GN-35M
	100	8	11	60	40	30	300	10	5:1	1.1	55QP	2735GN-100M
S-Band 3100-3500 MHz GaN on SiC HEMT Common Source	20	1	13	50	45	10	300	10	5:1	4.32	55QP	3135GN-20V*
	110	9	10.87	50	42	30	300	10	5:1	0.68	55QP	3135GN-110V*
	120	9	10.8	60	48	30	300	10	3:1	1.1	55QP	3135GN-120M
	170	12	11.5	60	35	60	300	10	3:1	0.6	55QP	3135GN-170M
	200	16	11	50	40	80	300	10	3:1	0.38	55QP	3135GN-200V*
	380	36	10	50	40	100	300	10	3:1	0.19	55KR	3135GN-400V*
C-Band 4400-6000 MHz GaN on SiC HEMT Common Source	100	9	10.45	60	50	30	100	10	3:1	1	55QP	4450GN-100
	70	7	10	60	39	30	100	5	3:1	0.94	55QP	5259GN-70

Microsemi supports customer specifications and develops custom products. Please contact the factory for more information.

1 For best efficiency GaN common source class AB transistor gate is turned off when pulse burst is not present peak & $I_{dq} = (I_{dq-ave}) / (\text{duty cycle})$

* Consult factory for final qualification information

** 32us on/ 18us off pulse burst of 48 pulses; total burst width of 2400us

Pulsed High Power Pallets

- L&S-band pulsed radar and avionics pallets
- 50Ω In / 50Ω out plug and play
- SMA connector friendly
- Copper heatsinks for excellent heat dissipation

Si Bipolar Class C	Frequency Band (MHz)	Pout Min (W)	Gain Min (dB)	Vcc/Vdd (V)	η Typ (%)	Idq Ave ¹ (mA)	Pulse Width (μs)	Duty Cycle (%)	Part Number
L-Band 1200-1400MHz Primary Surveillance Radar	1200-1400	550	8.5	42	55	--	300	10	1214-550P
	1200-1400	700	8.5	50	52	--	300	10	1214-700P
	1200-1400	800	8.6	50	52	--	300	10	1214-800P
S-Band 2700-3500MHz Primary Surveillance Radar	2700-2900	300	8	36	45	--	300	10	2729-300P
	2700-3100	200	8	36	45	--	200	10	2731-200P
	2700-3100	230	8.5	38	45	--	200	10	2731-230P

Power Solutions Modules

Microsemi RFIS – TS supplies a selected list of Power Solution Modules which consist of a pair of transistors mounted on a copper heat spreader and have terminal impedances of 50 Ohms thereby providing the user with a compact – ready to use (Plug and Play) unit that can be combined

to form a high power amplifier with minimal design cost. The PSM units are built to order and delivered within a few weeks. The photos below show a BJT as well as a GaN version.

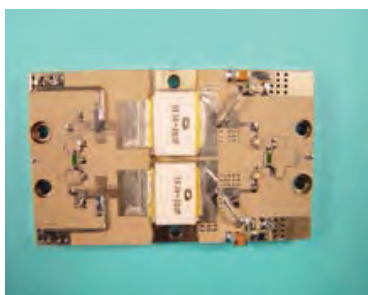

Pulsed Primary Radar

- Pulsed radar products for system operating bands:
 - VHF 150-160MHz
 - UHF 406-450MHz
 - P-Band 890-1000MHz
 - L-Band 1.2-1.4GHz & 1480-1650MHz
 - S-Band 2.7-3.5GHz
 - C-Band 4.4-5.0GHz & 5.2-6.0GHz
- Characterized to meet the system signal format on parameters such as: rise and fall time, pulse droop, gain spread short pulse, long pulse and combinations, gain change vs. frequency and temperature, and power saturation
- Wide band gap GaN on SiC HEMT (high electron mobility transistor) & SiC SIT (static induction transistor) semiconductor technologies²
- Si bipolar traditional high reliability technology transistor devices and products

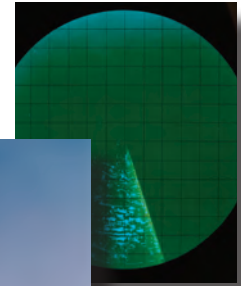
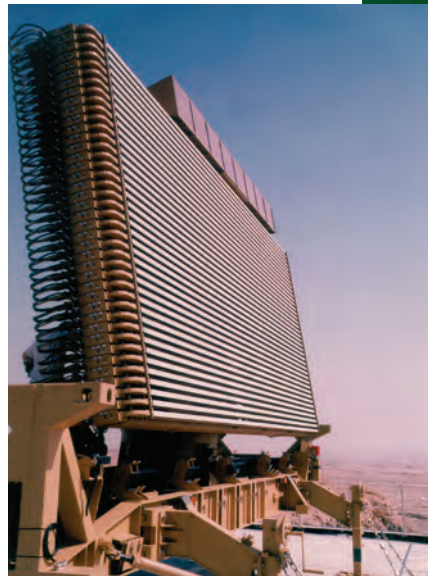

Notes to Pulsed Radar Table:

Microsemi supports customer specifications and develops custom products. Please contact the factory for more information.

- 1 For best efficiency GaN common source class AB transistor gate is turned off when pulse burst is not present $\text{peak} \ \& \ I_{dq} = (I_{dq-ave}) / (\text{duty cycle})$
- 2 For UHF through C-Band pulsed radar transistors: 1st two digits are low frequency band start and 2nd two digits are band end in 100's of MHz
- 3 GN=GaN & SC=SiC in part number

Pulsed Primary Radar

Devices	Pout Min (W)	Pin Max (W)	Gain Min (dB)	Vcc/Vdd (V)	η Typ (%)	Idq Ave ¹ (mA)	Pulse Width (μ s)	Duty Cycle (%)	VSWR Load	θ_{jc} (°C/W)	Case Style	Part Number ³
VHF 150-160 MHz SiC SIT Class AB Common Gate	1250	160	9.5	125	60	500	300	10	10:1	0.15	55KT-2	0150SC-1250M
UHF 400-500 MHz Si Bipolar Class C Common Emitter	300	33	9.6	40	50	--	250	10	20:1	0.2	M106	MS2176
	500	54	9.7	40	50	--	250	10	20:1	0.15	M102	MS2200
UHF 406-450 MHz SiC SIT Class AB Common Gate	100	11	10	125	50	30	300	10	10:1	2.5	55KT-FET	0405SC-100M
	500	55	10	125	50	125	300	10	10:1	0.3	55KT-FET	0405SC-500M
	1000	155	8.5	125	55	250	300	10	10:1	0.15	55ST-FET	0405SC-1250M
	1500	270	8	125	55	125	300	6	5:1	0.15	55ST-FET	0405SC-1500M
	2200	440	8	125	55	120	300	6	10:1	0.15	55TW-FET	0405SC-2200M
P-Band 890-1000 MHz Si Bipolar Class C Common Base	60	9.5	8	40	40	--	150	5	3:1	1	55AW-1	0910-60M
	150	23	8.1	48	40	--	150	5	3:1	0.48	55KT-1	0910-150M
	300	33	9.6	50	40	--	150	5	3:1	0.22	55KT-1	0910-300M
L-Band 1200-1400 MHz Si Bipolar Class C Common Base	2	0.35	7.5	28	45	--	CW	100	10:1	14	55LT	1014-2
	6	1.2	7	28	40	--	CW	100	10:1	9.0	55LV	1014-6A
	12	2.5	7.3	28	40	--	CW	100	10:1	4.5	55LT	1014-12
	30	6	7	28	48	--	2000	20	3:1	2.0	55AW-1	1214-30
	32	5.3	7.8	36	45	--	5000	20	3:1	2.3	55AW-1	1214-32L
	55	12.3	6.5	28	45	--	2000	20	3:1	1.0	55AW-1	1214-55
	110	20	8	50	55	--	330	10	3:1	0.65	55KT-1	1214-110M
	140	27	7.1	36	48	--	5000	20	3:1	0.55	55ST-1	1214-150L
	220	40	7.4	40	50	--	150	10	3:1	0.25	55ST-1	1214-220M
	270	42.7	8	50	45	--	100	10	3:1	0.22	55KT-1	1214-300
	300	40	8.7	40	55	--	150	10	3:1	0.29	55ST-1	1214-300M
370	50	8.7	50	50	--	330	10	2:1	0.29	55ST-1	1214-370M	
L-Band 1200-1400 MHz GaN on SiC HEMT Class AB Common Source	20	0.4	17	50	50	20	300	10	5:1	5.39	55KR	1214GN-20V*
	100	2.5	16	50	50	30	3000	30	3:1	1.1	55KR	1214GN-100LV*
	280	5.5	17	60	55	60	300	10	3:1	0.35	55KR	1214GN-280
	280	6.3	16.7	50	60	50	200	20	3:1	0.57	55KR	1214GN-280LV*
	500	8	18	60	55	50	300	10	3:1	0.16	55KR	1214GN-500
550	12	16.6	50	55	100	300	10	3:1	0.24	55KR	1214GN-550V*	
L-Band 1480-1650 MHz Si Bipolar Class C Common Base	20	3.5	8	36	40	--	200	10	3:1	1	55LV	1517-20M
	110	20.5	7.3	40	40	--	200	10	3:1	0.5	55AW-1	1517-110M
	500	--	17	60	48	--	400	10	3:1	0.16	55KR	1214GN-500
S-Band 2700-3500 MHz Si Bipolar Class C Common Base	65	11.5	7.5	36	40	--	120	10	2:1	0.5	55KS-1	3134-65M
	100	16	8	36	40	--	200	10	2:1	0.3	55KS-1	2731-100M
	110	16	11.7	36	40	--	200	10	5:1	1.1	55QP-1	2731-110M
	125	23	8	36	35	--	100	10	2:1	0.5	55KS-1	2729-125
	150	21.7	8.3	38	50	--	50	4	2:1	0.3	55KS-1	2931-150
	170	24	8.5	36	50	--	100	10	2:1	0.3	55KS-1	2729-170
S-Band 2700-2900 MHz GaN on SiC HEMT Common Source Class AB	150	10	11.76	50	50	30	100	10	5:1	0.92	55QP	2729GN-150V*
	150	8	12.7	60	50	30	100	10	3:1	1.1	55QP	2729GN-150
	270	12.6	13.3	60	55	60	100	10	3:1	0.6	55QP	2729GN-270
	270	16	12.7	50	55	60	100	10	3:1	0.38	55QP	2729GN-270V*
	400	28.2	11	65	50	80	100	10	3:1	0.24	55KR	2729GN-400
	500	35.5	11.5	65	54	100	100	10	3:1	0.2	55KR	2729GN-500
	500	36	11.4	50	50	100	100	10	3:1	0.18	55KR	2729GN-500V*
S-Band 2700-3100 MHz GaN on SiC HEMT Common Source Class AB	20	0.5	16	50	46	10	200	10	5:1	4.59	55QP	2731GN-20V*
	100	8	11	50	50	30	3000	30	3:1	1.02	55QP	2731GN-100LV*
	110	8	11.4	50	50	30	200	10	5:1	0.93	55QP	2731GN-110V*
	110	7.5	11.7	60	42	30	200	10	5:1	1.1	55QP	2731GN-110M
	200	12	12.2	60	42	50	200	10	3:1	0.6	55QP	2731GN-200M
	220	16	11.4	50	50	80	200	10	3:1	0.47	55QP	2731GN-220V*
	450	36	11	50	46	150	200	10	3:1	0.19	55KR	2731GN-450V*
S-Band 2700-3500 MHz GaN on SiC HEMT Common Source Class AB	35	2	12.4	60	40	15	300	10	5:1	2.4	55QP	2735GN-35M
	100	8	11	60	40	30	300	10	5:1	1.1	55QP	2735GN-100M
S-Band 3100-3500 MHz GaN on SiC HEMT Common Source Class AB	20	1	13	50	45	10	300	10	5:1	4.32	55QP	3135GN-20V*
	110	9	10.87	50	42	30	300	10	5:1	0.68	55QP	3135GN-110V*
	120	9	10.8	60	48	30	300	10	3:1	1.1	55QP	3135GN-120M
	170	12	11.5	60	35	60	300	10	3:1	0.6	55QP	3135GN-170M
	200	16	11	50	40	80	300	10	3:1	0.38	55QP	3135GN-200V*
	380	36	10	50	40	100	300	10	3:1	0.19	55KR	3135GN-400V*
C-Band 4400-6000 MHz GaN on SiC HEMT Common Source Class AB	100	9	10.45	60	50	30	100	10	3:1	1	55QP	4450GN-100
	70	7	10	60	39	30	100	5	3:1	0.94	55QP	5259GN-70

50 Ω Pallets Si Bipolar - Class C	Pout Min (W)	Pin Max (W)	Gain Min (dB)	Vcc/Vdd (V)	η Typ (%)	Idq Ave ¹ (mA)	Pulse Width (μ s)	Duty Cycle (%)	VSWR Load	θ_{jc} (°C/W)	Size (in)	Part Number
L-Band 1200-1400MHz Primary Surveillance Radar	550	--	8.5	42	55	--	300	10	--	--	--	1214-550P
	700	--	8.5	50	52	--	300	10	--	--	--	1214-700P
	800	--	8.6	50	52	--	300	10	--	--	--	1214-800P
S-Band 2700-2900MHz Primary Surveillance Radar	300	--	8	36	45	--	300	10	--	--	--	2729-300P
	200	--	8	36	45	--	200	10	--	--	--	2731-200P
S-Band 2700-3100MHz Primary Surveillance Radar	230	--	8.5	38	45	--	200	10	--	--	--	2731-230P

- Highest performance output power devices for all pulsed L-Band avionics systems
- Optimal devices for: Mode-5 IFF interrogators, Mode-S ELM transponders, TACAN, DME, Data Links, TCAS
- Characterized to meet avionics system specifications on parameters such as: rise and fall time, pulse droop, gain spread multimode pulsing combinations, gain change vs. frequency and temperature, power saturation, and spectral masks
- Wide band gap GaN on SiC HEMT (high electron mobility transistor)²
- Si bipolar traditional high reliability technology transistor devices and products



	Pout Min (W)	Pin Max (W)	Gain Min (dB)	Vcc/V dd (V)	η Typ (%)	Idq Ave ¹ (mA)	Pulse Width (μ s)	Duty Cycle (%)	VSWR Load	θ_{jc} ($^{\circ}$ C/W)	Case Style	Part Number
1030/1090 MHz Transponder/Interrogator Silicon Bipolar Class C Common Base	150	25	7.8	50	40	--	10	1	30:1	0.3	M138	MS2393
	175	25	8.5	50	40	--	10	1	30:1	0.45	55CX-1	TPR175
	400	75	7.3	50	40	--	10	1	20:1	0.2	55CT-1	TPR400
1090 MHz Transponder Silicon Bipolar Class A Common Emitter	0.2	0.02	10	18	--	--	CW	--	30:1	25	M115	MS2290
	0.6	0.05	10.9	18	--	--	CW	--	30:1	35	M220	MS2203
	0.6	0.05	10.9	18	--	--	CW	--	30:1	25	M115	MS2204
1090 MHz Transponder Silicon Bipolar Class C Common Base	2	0.25	9	28	35	--	10	1	--	10	M220	MS2201
	4	0.4	10	28	35	--	10	1	--	35	M115	MS2206
	35	5.6	8	50	30	--	10	1	--	2	M115	MS2341
	75	13	7.6	50	--	--	10	1	--	0.8	M115	MS2361
	95	10	9.7	40	40	--	10	1	--	0.6	M210	MSC1100
	350	70	6.9	50	40	--	10	1	20:1		M218	MSC1350M
	450	90	7	50	40	--	10	1	25:1	0.12	M216	MSC1450M
	500	150	5.2	50	35	--	10	1	10:1	0.1	55CT-1	TPR500
	500	150	5.2	50	35	--	10	1	10:1	0.1	55KT-1	TPR500A
	600	150	6	50	35	--	10	1	30:1	0.06	M112	MS2473
	700	150	6.7	50	35	--	10	1	10:1	0.08	55KT-1	TPR700
1000	208	6.8	50	43	--	10	1	9:1	0.06	55KV-1	TPR1000	
1030 MHz Interrogator Silicon Bipolar Class C Common Base	1000	158	8	50	45	--	1	1	4:1	0.08	55SW-1	ITC1000
	1000	100	10	50	50	--	1	1	4:1	0.08	55SW-1	ITC1100
1090 MHz TCAS Silicon Bipolar Class C Common Base	400	63	8	50	45	--	32	2	15:1	0.17	M216	MS2207
1030 MHz TCAS Silicon Bipolar Class C Common Base	450	100	6.5	45	35	--	32	2	10:1	0.06	55KT-1	TCS450
	800	100	9	45	45	--	32	1	4:1	0.09	55SM-1	TCS800
	1200	150	9	50	45	--	32	2	4:1	0.02	55TU-1	TCS1200
1030/1090 MHz Mode-S Silicon Bipolar Class C Common Base	70	6.5	10.3	50	35	--	128†	1	5:1	0.8	55CX-1	MDS70
	75	9	9.2	50	48	--	32	2	10:1	0.86	M214	MS2228
	150	20	10	50	40	--	128†	1	3:1	0.5	55AW-1	MDS150
	400	90	6.5	45	35	--	32	1	10:1	0.15	55KT-1	MDS400
	500	70	8.5	50	45	--	32	2	4:1	0.12	55ST-1	10500
	500	70	8.5	50	45	--	32	2	4:1	0.12	55SM-1	10502
	800	100	9	50	40	--	128†	1	4:1	0.12	55ST-1	MDS800
	1100	115	9.4	50	40	--	128†	1	4:1	0.02	55TU-1	MDS1100
1400	170	9.1	52	45	--	32	2	3:1	0.025	55TU-1	MDS1400	
1030/1090 MHz MODE S-ELM Silicon Bipolar Class C Common Base	60	6	10	50	40	--	2400	6.4	2:1	0.5	55AW-1	MDS60L
	140	15.7	9.5	50	50	--	2400††	6.4	2:1	0.15	55AW	MDS140L
	500	70	8.5	50	55	--	2400††	6.4	3:1	0.15	55ST-1	MDS500L
1030 MHz Mode-S ELM GaN on SiC HEMT Class AB Common Source	700	5	21.5	65	70	65	2400††	6.4	3:1	0.25	55KR	1011GN-700ELM
1030/1090 MHz Mode-S ELM GaN on SiC HEMT Class AB Common Source	650	5	20.8	65	65	100	2400††	6.4	3:1	0.25	55KR	MDS-GN-650ELM
	750	14.1	17.2	50	68	100	2400††	6.4	3:1	0.24	55KR	MDS-GN-750ELMV*
1030 MHz Mode-S/TCAS/IFF GaN on SiC HEMT Class AB Common Source	1000	17.8	17.5	50	55	100	32	2	3:1	0.12	55KR	1011GN-1000V*

	Pout Min (W)	Pin Max (W)	Gain Min (dB)	Vcc/ Vdd (V)	η Typ (%)	Idq Ave ¹ (mA)	Pulse Width (μ s)	Duty Cycle (%)	VSWR Load	θ_{jc} (°C/W)	Case Style	Part Number
960-1215 MHz DME/TACAN Si Bipolar Class C Common Base	7	1	8.5	50	25	--	10	1	10:1	3.5	55CT-1	0912-7
	15	1.5	10	50	30	--	10	1	10:1	2	M105	MS2321
	25	3.5	8.5	50	45	--	10	1	10:1	1.4	55CT-1	0912-25
	45	7	8.1	50	45	--	10	1	10:1	0.8	55CT-1	0912-45
1025-1150 MHz Air DME Si Bipolar Class A CW Common Emitter	0.6	0.05	10.8	18	--	--	CW	--	10:1	33	55FW-2	1000MP
1025-1150 MHz Air DME Si Bipolar Class C Common Base	2	0.3	10	35	45	--	20	1	10:1	10	55FW-1	1002MP
	2	0.25	9	35	35	--	10	1	20:1	10	M115	MS2202
	4	0.5	9	35	35	--	10	1	20:1	7	55FW-1	1004MP
	4	0.5	9	28	35	--	10	1	20:1	5	M220	MS2205
	5	0.55	9.5	28	--	--	10	1	20:1	8	M115	SD1526-01
	15	1.5	10	50	35	--	10	1	10:1	2	55FW-1	1015MP
	15	1.5	10	50	--	--	--	--	--	--	M115	MSC1015MP
	35	3.5	10	50	45	--	10	1	10:1	1	55FW-1	1035MP
	35	3	10.6	50	43	--	10	1	20:1	1	M220	MS2553
	35	3	10.7	50	48	--	10	1	20:1	1	M115	MS2575
	75	12	7.8	50	45	--	10	1	10:1	0.8	55FW-1	1075MP
	75	13	7.6	50	--	--	--	--	--	1	M115	MSC1075MP
	90	14	8.1	50	45	--	10	1	10:1	0.8	55FW-1	1090MP
	90	13	8.4	50	--	--	10	1	20:1	0.6	M115	SD1536-03
	90	13	8.4	50	--	--	10	1	20:1	0.6	M105	SD1536-08
	150	25	7.8	50	40	--	10	1	20:1	0.6	55AY-1	DME150
	175	30	7.6	50	40	--	10	1	20:1	0.3	M218	MSC1175M
	250	60	6.2	50	40	--	10	1	20:1	0.2	M218	MS2554
	300	70	6.3	50	35	--	10	1	30:1	0.2	M103	MS2421
	375	85	6.4	50	40	--	10	1	30:1	0.2	55AT-1	DME375A
400	90	6.5	50	--	--	10	1	30:1	0.12	M112	MS2441	
400	90	6.5	50	40	--	10	1	25:1	0.12	M216	MSC1400M	
500	125	6	50	35	--	10	1	10:1	0.1	55KT-1	DME500	
550	150	5.6	50	--	--	10	1	30:1	0.06	M112	MS2472	
800	100	9	50	40	--	10	1	5:1	0.05	55ST-1	DME800	
1025-1150 MHz Air DME GaN on SiC Class AB Common Source	700	12.6	17.4	50	60	100	20	6	3:1	0.21	55KR	DME-GN-700V*
960-1215 MHz Data Link Si Bipolar Class C Common Base	6	0.7	9.3	28	45	--	6.4	21	5:1	7	M222	MS2211
	15	2.3	8.1	28	45	--	10	21	20:1	3	M222	MS2212
	25	5	7	36	40	--	10	40	5:1	1.8	55AT-1	JTDB25
	30	5	7.8	35	40	--	6.4	21	15:1	2.2	M214	MS2213
	50	10	7	36	40	--	10	22	10:1	0.8	55AT-1	JTDA50
	75	15	7	36	40	--	10	40	3:1	0.8	55AT-1	JTDB75
	85	15	7.5	35	40	--	6.4	21	5:1	0.75	M218	MS2214
	145	25	7.6	36	45	--	7	22	3:1	0.5	55KT-1	JTDA150A
	150	26.7	7.5	35	45	--	7	21	--	0.57	M216	MS2215
	960-1215 MHz TACAN Si Bipolar Class C Common Base	15	3	7	40	40	--	20	5	10:1	1	55LT-1
75		12	8	50	40	--	20	5	30:1	0.6	55AZ-1	TAN75A
90		13	8.4	50	38	--	10	10	--	0.8	M218	MS2209
150		30	7	50	38	--	20	5	10:1	0.3	55AT-1	TAN150
250		60	6.2	50	40	--	20	5	5:1	0.3	55AT-1	TAN250A
250		40	8	50	38	--	20	5	--	0.28	M214	MS2267
300		60	7	50	38	--	10	10	15:1	0.16	M216	MS2210
300		60	7	50	45	--	20	5	5:1	0.15	55KT-1	TAN300
350		60	7.6	50	38	--	10	10	15:1	0.16	M216	MS2272
350		70	7	50	40	--	10	10	3:1	0.12	55ST-1	TAN350
500	70	9	50	40	--	10	10	3:1	0.07	55ST-1	TAN500	
960-1215 MHz HD Data Link GaN on SiC HEMT Class AB Common Source	20	0.4	17	50	55	10	128	10	5:1	6.56	55KR	0912GN-20V*
	100	2.5	16	50	55	30	3000	30	3:1	1.07	55KR	0912GN-100LV*
	300	4	17.5	65	55	50	128	10	3:1	0.3	55KR	0912GN-300
	300	6.3	16.8	50	55	50	128	10	3:1	0.44	55KR	0912GN-300V*
	600	8	18	65	55	100	128	10	3:1	0.2	55KR	0912GN-600
650	11.2	17.6	50	58	100	128	10	3:1	0.23	55KR	0912GN-650V*	

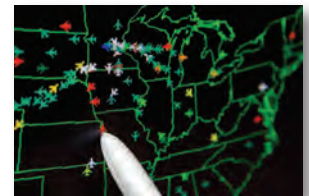

Microsemi supports customer specifications and develops custom products.

Please contact the factory for more information.

1 For best efficiency GaN common source class AB transistor gate is turned off

when pulse burst is not present peak & Idq=(Idq-ave)/(duty cycle)

2 "GN" in part number denotes a GaN on SiC device

† Burst of 0.5us ON/0.5us OFF x128 repeated at 6.4ms

†† Burst of 32us ON/18us OFF x 48 repeated at 24ms

*Consult factory for final qualification information

High Reliability Transistors

Microsemi Transistor Solutions: Hi Rel Screening Capability and Products

Post Production Screening Tests

One hundred percent electrical screening of finished product is performed to guarantee that products comply with the customer supplied specification or data sheet. One hundred percent reliability testing is designed to remove latent failures and is also performed on all Microsemi RF & microwave power transistor products. These tests are designed with a "screening by failure model" philosophy in mind. Our standard 100% processing is detailed in Table I. Standard 100% processing complies with MIL-STD-883 and MIL-STD-750.

Qualification Tests

All hermetic (solder sealed) Microsemi RF & microwave power transistor devices are capable of passing the standard matrix of environmental testing per MIL-STD-750. The tests stress the hermetic seal, the lead attachment and in general assure that the devices which pass the test matrix are inherently reliable in severe military-type environments. The tests are outlined in Table 2. Samples of current production, as well as samples of any new package design, are routinely subjected to this standard test matrix. Data exists in reliability files verifying conformance of Microsemi transistor devices in various packages to the environmental test sequence. This test matrix complies with MIL-STD-750.

Application	Freq Range	Power Out (W)
UHF Comm	100-500 MHz	50
	225-400MHz	125
	500-1000MHz	50
S-Band Telem	2200-2400 MHz	6
	2200-2500MHz	4
	2300-2400 MHz	20
Avionics	1030/1090MHz	600 Pk
	1030 MHz	1100 Pk
	960-1215MHz	75 Pk
	960-1215MHz	250 Pk
	960-1215MHz	350 Pk
	960-1215MHz	75 pk
	960-1215MHz	150 pk

Application	Model	Freq Range	Power Out (W)
Class A	23003H/HS	1000-2300 MHz	0.3
	23A008H/HS	1000 - 2300 MHz	0.8
UHF Radar	0405SC-1000MH	406 - 450 MHz	1000 pk
P-Band Radar	0709-50H	650-850 MHz	50 Pk
	0709-240H	650-850 MHz	240 Pk
	0709-500H	650 - 850 MHz	500 Pk
L-Band Radar	1014-6AH	1215-1400 MHz	6
	1214-30H	1215-1400 MHz	30 pk
	1214-55H	1215-1400 MHz	55 pk
	1214-300HS	1215-1400 MHz	300 pk
S-Band Radar	2729-170H	2700-2900 MHz	170 Pk

Table 1

TEST	MIL-STD-750 or TS (as noted)	Level			
		A	B	C	JANTXV
Wafer Probe -- DC	Wafer Probe Spec	100%	100%	100%	100%
SEM Wafer Inspection	MIL-STD-883	--	--	OPT	--
Wafer Qual	DC/RF Electrical	All Wfr	All Wfr	All Wfr	All Wfr
Die Visual	TS Specification	100%	100%	100%	100%
Die Shear	2017	Note1	Note1	Note1	Note1
Bond Strength	2037	Note1	Note1	Note1	Note1
Precap Visual	2072	AQL	100%	100%	100%
100% Electrical	TS Specification	100%	100%	100%	100%
Storage	1032	--	OPT	100%	100%
Temperature Cycling	1051 Condition D	--	OPT	100%	100%
Constant Acceleration	2006, Y1	--	OPT	100%	100%
PIND Test	2052	--	OPT	100%	100%
Gross Leak	1071.1 Condition H	100%	100%	100%	100%
Fine Leak	1071.1 Condition C	AQL	100%	100%	100%
HTRB	1039 Condition A, 48 hrs	--	100%	100%	100%
Burn - In	1039 Condition B	--		100%	100%
DC Electrical	Product Specification	100%	100%	100%	100%
RF Electrical	Product Specification	100%	100%	100%	100%
Ext Visual / Mechanical	2071	AQL	AQL	AQL	--
Final QA	TS Specification	AQL	AQL	AQL	--
Group A,B,C	Done on Request	--	--	LTPD	LTPD

Notes:

1. Destructive test on line monitor of production equipment
- A) Standard Manufacturing Testing
- B) Reliability Testing
- C) High Reliability Screening

High Reliability Transistors

Table 2

	MIL-STD-750		
EXAMINATION OR TEST	METHOD	CONDITION	Class B LTPD
Group B Tests			
Subgroup 1			
Physical Dimensions	2066	Test Condition A	15
Subgroup 2			
(a) Marking Permanency	2008	Test Condition B 3.2.1	4 devices (no failures)
(b) Visual & Mechanical	2071	Test Condition B	1 device (no failures)
(c) Bond Strength	2037	Test Condition D	15
(d) Die Shear	2017		
Subgroup 3			
Solderability	2026	Soldering temp of 260+ 10oC	15 Leads
Subgroup 4			
Terminal Strength	2036	Test Condition B2	15
Seal	1071		
(a) Fine		Condition H	
(b) Gross		Condition C	
Group C Tests			
Subgroup 1			
Thermal Shock	1011	Test Condition B	15
Temperature Cycling	1010	Test Condition C	
Moisture Resistance	1004		
Seal	1014		
(a) Fine		Condition H	
(b) Gross		Condition C	
End Point electrical parameters		As Specified	
Subgroup 2			
Mechanical Shock	2016	3 Axis	15
Vibration Variable	2056		
Constant Acceleration	2006		
Seal	1071		
(a) Fine		Condition H	
(b) Gross		Condition C	
End Point Electrical parameters		As Specified	
Subgroup 3			
Salt Atmosphere	1041		15

HF / VHF / UHF Communications

HF Industrial/Communications

- 2-175MHz single ended or balanced transistors Si bipolar for Class AB/C operation
- 1-250W CW or Pulsed at 28V & 50V
- RF Power for FM/SSB mobile and base stations, high power amplifiers, and industrial, scientific, and medical equipment

VHF Communications

- 50-175MHz single ended or balanced transistors for common emitter class C operation Si Bipolar
- 1-150W CW biased at 12.5V, 28V, or 50V
- AM/FM mobile and base station applications

UHF Communications

- Common emitter and common base class C single-ended and balanced Si bipolar transistor
- 225-400MHz, 1.5-125W, 12.5V or 28V
- 450-512MHz, 1-45W at 12.5V
- 836-960MHz, 1-45W at 12.5V

Military Communications

- 100-500MHz, 1-125W CW, 28V, ClassA/AB/C single-ended or balanced Si bipolar transistors



HF Si Bipolar Class AB	Pout Min (W)	Pout Max (W)	Gain min (dB)	Vcc (V)	η Typ (%)	Icq (mA)	VSWR Load	θ_{jc} ($^{\circ}$ C/W)	Case Style	Part Number
2-30 MHz Common Emitter	100	7.9	11	12.5	50	150	20:1	0.6	M174	MS1051
	130	8.2	12	28	50	150	20:1	1	M174	MS1078
	150	6	14	50	50	100	20:1	0.75	M174	MS1007
	150	6	14	50	50	100	20:1	0.75	M164	MS1008
	220	13.9	12	28	50	750	20:1	0.7	M174	MS1076
	220	11	13	50	50	150	20:1	0.7	M174	MS1079
	250	10	14	50	50	150	20:1	0.4	M177	MS1004
	250	10	14	50	50	150	20:1	0.4	M177	MS1011

HF/VHF/UHF Si Bipolar Class C	Pout Min (W)	Pin Max (W)	Gain Min (dB)	Vcc (V)	η Typ (%)	Cob (pF)	VSWR Load	θ_{jc} ($^{\circ}$ C/W)	Case Style	Part Number
HF 2-50 MHz Common Emitter	20	0.65	15	12.5	60	100	20:1	2.2	M113	MS1227
	30	0.48	18	28	60	--	20:1	2.2	M113	MS1226
	75	3.8	14	12.5	60	350	20:1	2.2	M174	MS1001
	200	12	12	50	60	300	30:1	0.65	55HX-2	S200-50
	250	9	14.5	50	37	360	20:1	0.4	M177	MS1004
VHF 100-175 MHz Common Emitter	0.75	0.015	17	12.5	--	4	--	125	SO-8	SRF4427
	1	0.1	10	12.5	50	4	--	175	TO-39	2N4427
	1.4	0.1	12	7.5	50	6	20:1	35	M123	MS1403
	1.75	0.125	12	12.5	50	15	--	35.7	TO-39	MRF607
	2.5	0.2	11.5	7.5	50	19	20:1	11.6	M123	MS1401
	3	0.5	8	12.5	50	15	--	35	TO-39	2N6255
	4	0.25	12	12.5	50	20	--	22	TO-39	SD1127
	10	0.1	10	12.5	--	45	20:1	8.75	M135	SD1143
	10	0.1	10	12.5	--	45	20:1	8.75	M113	SD1143-01
	10	1	10	28	55	15	20:1	13.5	M135	SD1013
	10	1	10	28	55	15	20:1	13.5	M113	SD1013-03
	15	1	12	12.5	60	45	20:1	8.75	M122	MS1261
	15	3.5	6.3	12.5	60	10	20:1	5.6	M113	SD1014-06
	20	3	8.2	28	55	35	--	5.83	M113	MS1408
	20	3	8.2	28	60	35	20:1	5.8	M135	MS1406

HF / VHF / UHF Communications

HF/VHF/UHF Si Bipolar Class C	Pout Min (W)	Pin Max (W)	Gain Min (dB)	Vcc (V)	η Typ (%)	Cob (pF)	VSWR Load	θ_{jc} (°C/W)	Case Style	Part Number
	30	3	10	13.5	55	95	20:1	1.2	M135	MS1504
	30	3	10	12.5	--	120	10:1	1.2	M135	MS1336
	30	3	10	12.5	--	120	10:1	1.2	M113	MS1337
	30	3	10	28	--	250	--	4.4	M135	SD1015
	30	3	10	13.5	55	95	20:1	1.2	M113	MS1505
	40	7	7.6	28	60	65	20:1	2.9	M135	SD1224
	40	5	9	13.6	55	95	20:1	1.2	M135	MS1506
	40	5	9	13.6	--	95	--	1.2	M113	MS1507
	40	14	4.5	12.5	70	200	10:1	2.2	M135	SD1018
	40	14	4.5	12.5	70	200	10:1	2.2	M113	SD1018-06
	60	12	7	28	55	80	20:1	2.3	M135	MS1329
	80	10	9	27	65	75	30:1	2	55HT-2	VAM80
	100	25	6	28	50	150	--	0.75	M174	MS1204
	100	25	6	12.5	--	390	10:1	0.65	M111	MS1003
	100	20	7	28	60	220	30:1	0.65	55HV-2	VMIL100
	150	18	9.5	28	70	150	20:1	0.75	M174	MS1281
UHF 225-400 MHz Common Emitter	3	0.2	11.8	28	60	4.5	30:1	16	55FT-2	UMIL3
	10	0.65	12	28	50	12	--	6.4	M123	MS1642P
	10	1	10	28	60	11.5	30:1	6.3	55FT-2	UMIL10
	10	1	10	28	50	11.5	10:1	6.3	55FU-2	UMIL10P
	25	3.2	8.9	28	50	22	5:1	2.5	55HV-2	UMIL25
	60	8	8.8	28	60	70	5:1	1.25	55HW-2	UMIL60
	70	10	8.5	28	50	65	20:1	0.8	M111	MS1511
	80	10	9	28	60	80	5:1	0.8	55HV-2	UMIL80
	100	20	7	28	60	100	--	0.7	M111	MS1503
	100	19	7.2	28	55	120	5:1	0.7	55HV-2	UMIL100
	100	16	8	28	55	120	4.5:1	0.7	55JU-2	UMIL100A
	125	25	8.5	28	60	70	--	0.65	55JT-2	0204-125
UHF 100-500 MHz Common Emitter	50	7	8.5	28	55	52	5:1	1.25	55JT-2	0105-50
	100	28.2	5.5	28	55	100	5:1	0.67	M168	MS1509
UHF 470 MHz General Purpose	2	0.2	10	--	12.5	10	--	35	M122	MS1402
	2	0.32	8	50	12.5	15	--	35	TO-39	SD1444
	3	0.34	9.5	50	12.5	12	--	35	TO-39	MS1649
	5	0.7	8.5	50	12.5	19	20:1	11.6	M122	MS1404
	5	0.5	10	60	12.5	15	--	11.6	M123	MS652S
	10	2	7	--	12.5	26	20:1	3	M122	MS1426
	10	2.5	6	--	12.5	30	--	4.7	M122	SD1146
	15	2.5	7.8	50	12.5	50	--	4.6	M142	MS1263
	15	2.7	7.5	--	12.5	50	20:1	4.6	M111	SD1429-03
	25	6	6.2	--	12.5	70	20:1	2.5	M111	SD1422
UHF 836-960 MHz General Purpose	1.5	0.24	8	12.5	60	6	--	25	Pwr Macro	MRF557
	45	15	4.7	12.5	--	100	20:1	1.2	M142	MS1455

General Purpose & Small Signal

Small Signal

- Transistors for common emitter class A operation up to 1 GHz
- Device gain >10dB with NF<2.5dB at 5, 7.5, 10, 12, and 15VDC
- Applications include: gain blocks, low noise amplifiers, and oscillators
- Thru-hole metal cans, plastic Macro, SO-8, SOT-23 and SOT-143 packages
- Applications include: PA stage for hand-held radios & low power amplifier driver stage

Small Signal	Freq (MHz)	Freq (MHz)	GNF (MHz)	VCE (V)	Ic (mA)	NF min (dB)	Case Style	Part Number
Up to 1 GHz Si Bipolar Class A Common Emitter 	100	1500	20	6	5	4.5	TO-72	2N5179
	200	1200	12	15	50	--	TO-39	2N5109
	200	1400	-	6	1.5	4.5	SOT-23	MMBR5179LT1
	250	1400	13.5	25	50	--	TO-39	MRF545
	250	1500	13.5	25	50	--	TO-39	MRF544
	300	3000	12	15	40	--	TO-39	MRF586
	300	3000	10	15	60	2.5	TO-39	MRF517
	400	1200	12	6	1	--	TO-72	2N5031
	500	1300	20	5	25	2.5	TO-72	BFY90
	500	1400	14	10	14	5	TO-72	2N6304
	500	1600	13	10	12	5.5	TO-72	2N2857
	500	4500	-	1.5	3	3	SOT-23	BFR92ALTI
	500	4500	15	10	15	2.5	TO-72	MRF914
	500	5000	16	5	30	1.9	Macro T	BFR91
	500	5000	18	5	14	2.5	Macro T	BFR90
	1000	4000	7	10	15	1.5	TO-72	MRF904
1000	6000	11	10	10	2.9	SOT-23	MMBR911LT1	

Power Devices

- Transistors for common emitter class A, B, and C operation up to 1 GHz
- Device gain >8dB & Pout up to 4W at 7.5V and 12V
- Mobile and held and mobile predriver amplifier applications
- Thru-hole metal cans, plastic Macro, and SO-8 packages
- Applications include: land mobile and RFS radios, wireless alarms, and keyless entry

Power Devices	Freq (MHz)	Supply (V)	Pout (W)	Gain (dB)	Style	Packing	Part Number
Up to 1 GHz Si Bipolar Class A/B/C Common Emitter	175	12.5	1	10	TO-39	500 Units Bulk	2N4427
	175	12.5	1	17	SO-8	500 Units Bulk	SRF4427
	175	12.5	1.75	11.5	TO-39	500 Units Bulk	MRF607
	175	12.5	3	7.8	TO-39	500 Units Bulk	2N6255
	175	12.5	4	12	TO-39	500 Units Bulk	SD1127
	400	28	1	10	TO-39	500 Units Bulk	2N3866
	400	28	1	10	TO-39	500 Units Bulk	2N3866A
	400	28	1	10	SO-8	500 Units Bulk	MRF3866
	470	12.5	3	10	TO-39	500 Units Bulk	MS1649
	470	12.5	2	8	TO-39	500 Units Bulk	SD1444
	870	12.5	0.75	8	Pwr Macro	500 Units Bulk	MRF837
	870	12.5	1.5	8	Pwr Macro	500 Units Bulk	MRF557

VHF TV Broadcast

- 50-175MHz single ended or balanced transistors for common emitter class A & AB operation
- 0.5-250W Psync with 28-32V Vcc

UHF TV Broadcast

- 50-225MHz single ended or balanced Si Bipolar transistors for common emitter class A & AB operation
- 0.5-150W Psync with Vcc of 28V

	Freq (MHz)	Pout Min (W)	Gain Min (dB)	Vcc (V)	η Typ (%)	Icq (mA)	IMD Typ (dB)	VSWR Load	θ_{jc} (°C/W)	Case Style	Part Number
VHF TV 174-225 MHz Class A/AB Common Emitter	225	14	14	28	--	2.5	-55	--	1.5	M111	MS1277
	225	20	8	25	--	2.5	-50	--	1.2	M130	MS1279
	225	20	7.5	28	--	3.5	-50	--	1.2	M164	MS1280
	225	100	11	28	--	0.2	-50	--	1.2	M168	MS1278
UHF TV 470-860 MHz Class A Common Emitter	225	200	11	32	--	1	-50	--	0.45	M175	SD1485
	860	0.5	10	20	--	0.22	-60	30:1	22	55FT-2	UTV005
	860	1	10	20	--	0.44	-60	30:1	12	55FT-2	UTV010
	860	2	10	25	--	0.41	-60	30:1	10	55FT-2	UTV020
	860	4	8.5	25	--	0.85	-60	30:1	7	55FT-2	UTV040
	860	8	9	26.5	--	1.7	-58	3:0:1	2.5	55JV-2	UTV080
	860	12	8.9	26.5	--	1.7	-52	3:0:1	1.6	55JT-2	UTV120
UHF TV 470-860 MHz Class AB Common Emitter	860	20	8.5	26.5	--	2.7	-48	3:0:1	1.2	55JV-2	UTV200
	860	100	8.5	28	55	0.3	--	5:0:1	0.6	55RT-2	UTV8100B
UHF 860-960 MHz Class A/AB Common Emitter	860	0.5	9.5	20	--	0.22	-60	--	5.5	M122	MS1502
	860	1	10	20	--	0.44	-60	--	9	M122	MS1512
	860	2	8.5	25	--	0.45	-60	--	11	M122	MS1501
	860	4	7	25	--	0.85	-60	--	5.5	M122	MS1581
	860	14	8.5	25	--	1.65	-45	--	2.5	M156	MS1579
	860	25	9	25	--	3.2	-45	--	1.3	M173	MS1582
	860	30	7.5	24	50	0.06	-60	--	2	M142	MS1454
	860	150	6.5	28	45	2x0.5	--	--	0.55	M175	MS1533
	960	0.9	9.5	24	--	0.125	--	--	20	M123	SD1420-01
960	30				24				M142	MS1453	

- Si Bipolar Common Base Class C operation
- All gold metalization and glass passivation for high reliability and long term operation
- Each device fully tested to the specification

Microwave

Microwave	Freq (MHz)	Pout Min (W)	Pout Max (W)	Gain min (dB)	Vcc (V)	η Typ (%)	Cob (pF)	VSWR Load	θ_{jc} (°C/W)	Case Style	Part Number
2.0 GHz Si Bipolar Class C Common Base	2000	1	0.125	9.5	28	40	4	30:1	35	55BT-1	2001
	2000	1	0.2	7	28	35	3.2	30:1	25	M210	MS3022
	2000	3	0.47	8.6	28	40	5	30:1	15	55BT-1	2003
	2000	3	0.5	7.8	28	35	9.5	--	8	M210	MS2003
2.3 GHz Si Bipolar Class C Common Base	2300	1.5	0.24	8.5	20	40	4	30:1	31	55BT-1	2301
	2300	4	0.63	8.5	20	40	7	10:1	17	55BT-1	2304
	2300	7	1.1	8.5	20	40	10	10:1	8.5	55BT-1	2307

Microwave Broadband	Freq (MHz)	Pout Min (W)	Pin Max (W)	Gain min (dB)	Vcc (V)	η Typ (%)	Cob (pF)	VSWR Load	θ_{jc} (°C/W)	Case Style	Part Number
1000 -1400 MHz Si Bipolar Class C Common Base	1000 - 1400	6	1.2	7	28	40	6.5	10:1	9	55LV-1	1014-6A
	1000 - 1400	12	2.5	7.3	28	40	12	30:1	4.5	55LT-1	1014-12
1700-2000 MHz Si Bipolar Class C Common Base	2200 - 2300	1.7	0.25	8.5	22	35	--	10:1	24	55LV-1	2223-1.7
	2200 - 2400	6	1.2	7	22	40	--	10:1	8	55LV-1	2224-6L
	2200 - 2500	3.5	0.5	8.5	24	40	7	10:1	17	55LV-1	2225-4L
	2400 - 2470	25	4.4	7.5	24	49	--	3:1	2.5	55AP-1	2424-25

Linear/Communications/Bias

Linear

- Class A driver transistors for applications from 1MHz-2.3GHz and power levels from 0.25-20W
- Emitter balasted transistors are fully tested under bias conditions for linearity, power gain, load mismatch tolerance
- Class A driver transistors for applications from 1MHz-2.3GHz and power levels from 0.25-20W

Si Bipolar Class A Common Emmiter	Freq (MHz)	Pout Min (W)	Pin Max (W)	Gain min (dB)	Vcc (V)	Icq (pF)	Cob (pF)	VSWR Load	θjc (°C/W)	Case Style	Part Number
100-500 MHz	1-500	0.5	0.02	12	12.5	0.25	-	30:1	33	55AZ-2	MPA201
500-1000MHz	1000	0.5	0.08	9	20	0.14	2	30:1	33	55ET-2	1A5
	1000	1.5	0.2	9.5	20	0.22	3.8	30:1	29	55FT-2	10A015
	1000	3	0.5	9	20	0.44	7.3	6:1	12.5	55FT-2	10A030
	1000	6	0.95	8.5	20	0.88	10.8	10:1	8.3	55FT-2	10A060
500-1000 MHz Internal Pre-match	1000	5	0.5	10	20	1	16	30:1	7	55CT-2	10AM05
	1000	20	3	8	20	2.8	40	30:1	1.5	55AT-2	10AM20
1.0-2.0 GHz (Operational from DC to 2.0 GHz)	2000	0.11	0.012	9	18	0.05	2.5	20:1	45	M210	MSC80064
	2000	0.5	0.1	7	20	0.14	2	30:1	33	55ET-2	2A5
	2000	0.8	0.15	7	20	0.18	2	6:01	33	55EU-2	2A8
	2000	1	0.2	7	18	0.22	5	15:1	17	M210	MS3011
2.0-2.3 GHz, Class A, Common Emitter (Operational from DC to 2.3 GHz)	2300	0.3	0.03	10	15	0.1	2.5	9:1	45	55BT-2	23A003
	2300	0.5	0.07	9.5	20	0.12	2.4	6:1	35	55BT-2	23A005
	2300	0.8	0.14	9.5	20	0.14	3	10:1	35	55BT-2	23A008
	2300	1.7	0.34	7.6	20	0.27	4.8	6:1	16	55BT-2	23A017
	2300	2.5	0.6	6.5	20	0.42	6.5	10:1	11	55BT-2	23A025
	2300	1	0.16	10	15	0.2	3.4	30:1	30	55BT-2	80143

Communications Linear

- Broadband, high power class AB linear transistor
- Highest power output covering the full 500-1000MHz range

Si Bipolar Class AB Common Emitter	Freq (MHz)	Pout Min (W)	Pin Max (W)	Gain min (dB)	Vcc (V)	Icq (pF)	η Typ (%)	VSWR Load	θjc (°C/W)	Case Style	Part Number
500-1000 MHz	1000	50	10	7	28	0.1	50	30:1	1.4	55AV-2	0510-50A

Bias Devices

- Designed for use in the biasing of high power silicon transistors
- Feature excellent thermal tracking to provide the highest performance over the entire operating temperature range

Bias Current (A)	Resistance (Ohm)	Case Style	Part Number
0.35	1	55FV	BYI-1
0.35	1	55GV	BYI-1F
TO 0.35	1	55GU	Z0-28F
0.35	1	55FU	BYI-1Z
0.35	1	55LU	

Case Styles

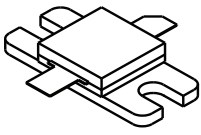

55AP

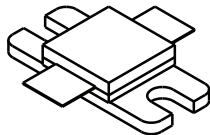

55AR

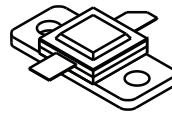

55AT

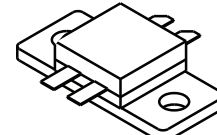

55AV

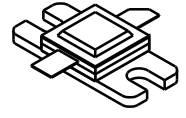

55AW

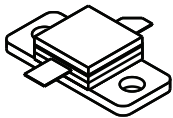

55AY

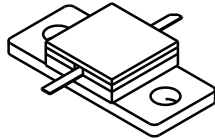

55AZ

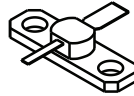

55BT

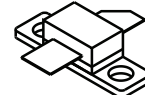

55CT

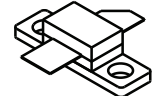

55CX

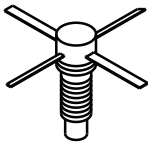

55ET

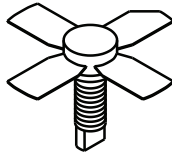

55FT

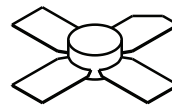

55FU

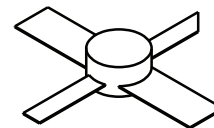

55FW

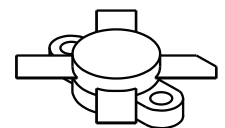

55HT

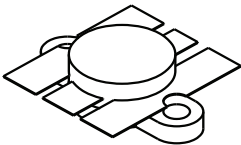

55HV

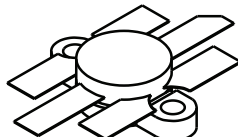

55HW

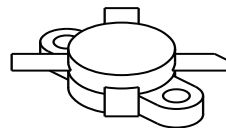

55HX

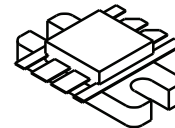

55JT

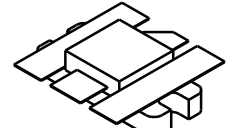

55JU

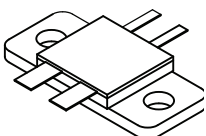

55JV

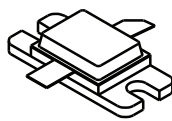

55KT

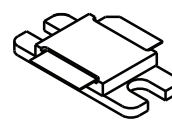

55KS

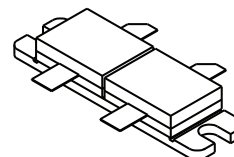

55KV

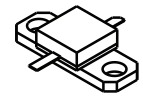

55LT



55LU

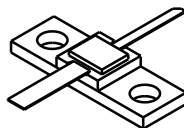

55LV

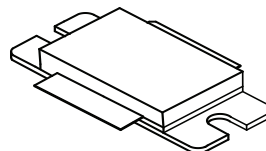

55QM

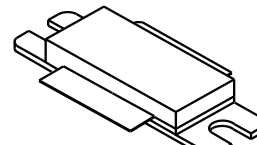

55QX

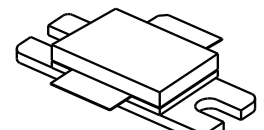

55QZ

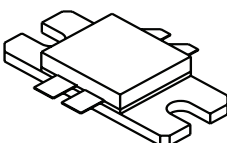

55RT

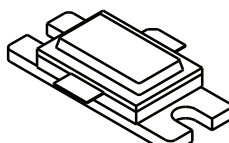

55SM

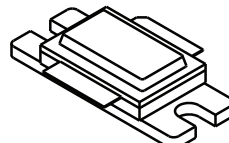

55ST

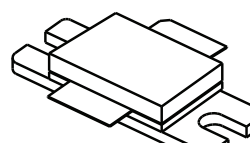

55SW

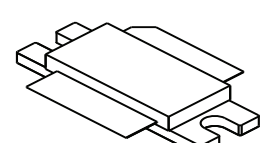

55TU

Case Styles

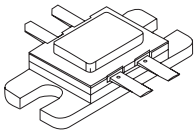

M102

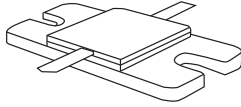

M103

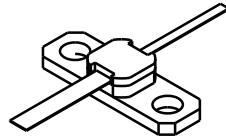

M105

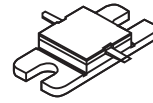

M106

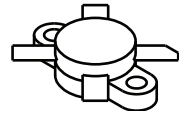

M111

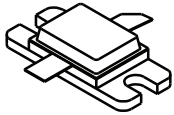

M112

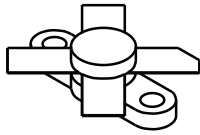

M113

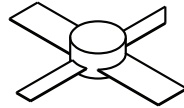

M115

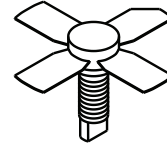

M122

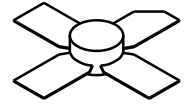

M123

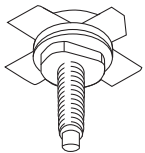

M130

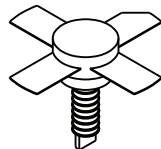

M135

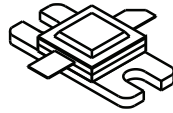

M138

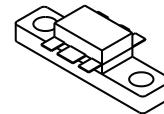

M142

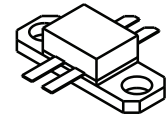

M156

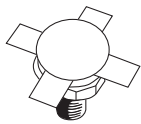

M164

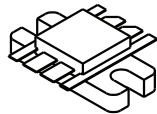

M168

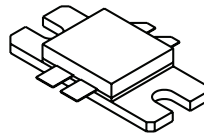

M173

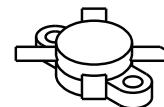

M174

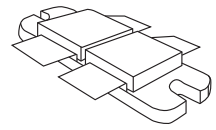

M175

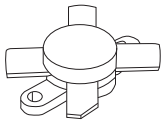

M177

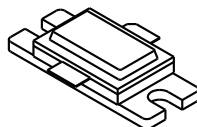

M198

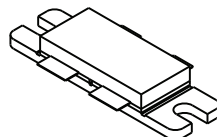

M208

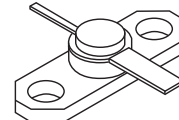

M210

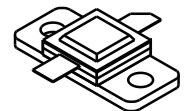

M214

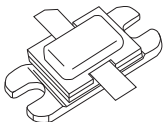

M216

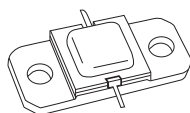

M218

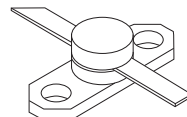

M220

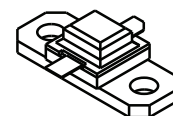

M222

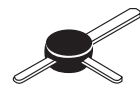

Macro T

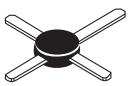

Macro X



Power Macro

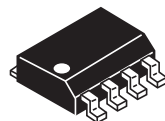

SO-8

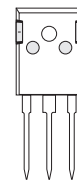

TO-247



TO-39



TO-72

Diode Products:

Microsemi Corporation
RF Integrated Solutions
75 Technology Drive
Lowell, MA 01851-5293
+1.978.442.5600
+1.978.937.3748

Power Transistor Products:

Microsemi Corporation
RF Integrated Solutions
3000 Oakmead Village Drive
Santa Clara, CA 95051-0808
+1.408.986.8031
+1.408.986.8120

www.microsemi.com

email: sales.support@microsemi.com



Microsemi

Microsemi Corporate Headquarters

One Enterprise, Aliso Viejo, CA 92656 USA

Within the USA: +1 (949) 380-6100

Sales: +1 (949) 380-6136

Fax: +1 (949) 215-4996

email: sales.support@microsemi.com

www.microsemi.com

Microsemi Corporation (Nasdaq: MSCC) offers a comprehensive portfolio of semiconductor and system solutions for communications, defense & security, aerospace and industrial markets. Products include high-performance, radiation-hardened and highly reliable analog mixed-signal integrated circuits, FPGAs, SoCs and ASICs; power management products; timing and voice processing devices; RF solutions; discrete components; security technologies and scalable anti-tamper products; Power-over-Ethernet ICs and midspans; as well as custom design capabilities and services. Microsemi is headquartered in Aliso Viejo, Calif., and has approximately 3,000 employees globally. Learn more at www.microsemi.com.

©2013 Microsemi Corporation. All rights reserved. Microsemi and the Microsemi logo are trademarks of Microsemi Corporation. All other trademarks and service marks are the property of their respective owners.

MS4-009-13

Mouser Electronics

Authorized Distributor

Click to View Pricing, Inventory, Delivery & Lifecycle Information:

[Microchip:](#)

[0405SC-500M](#) [0405SC-100M](#)