

# 厚膜片式網絡電阻器

## Thick Film Chip Network Resistor

### ■ 特點 Features

- 體積小、重量輕  
Miniature and light weight
- 適應再流焊  
Suit for reflow solder
- 電性能穩定，可靠性高  
Stable electrical capability, high reliability
- 裝配成本低，并與自動貼裝設備匹配  
Low assembly cost, suit for automatic SMT equipment
- 機械强度高、高頻特性優越  
Superior mechanical and frequency characteristics
- 符合RoHS指令要求  
Compliant with RoHS directive



### ■ 品名構成 Type Designation

RC-M	L	08	W	100	F	T			
產品代號 Product Code	型號代號 Type Code		端子數 Terminal Number	端子形狀 Terminal Style	電阻值代號 Resistance Value Code	電阻值誤差精度代號 Resistance Tolerance Code	包裝方式代號 Packaging Style Code		
厚膜片式網絡電阻器 Thick Film Chip Network Resistor	代號 Code	型號 Type	04	凸電極 直角 Convex type with corner	三位數(E-24系列): 前兩位表示有效數字, 第三位表示有效數字后零的個數。Three digits(E-24 series): The first two digits are significant figures and the third one denotes number of zeros. 四位數(E-96系列): 前三位表示有效數字, 第四位表示有效數字后零的個數。Four digits(E-96 series): The first three digits are significant figures and the four one denotes number of zeros. 小數點用R表示。Decimal point should be expressed by "R". 例如 Example: 103=10kΩ (E-24) 1003=100kΩ (E-96) 1R0=1.0Ω (E-24) 000=0Ω	代號 Code	誤差精度 Tolerance	代號 Code	包裝方法 Packaging Style
	T	0402型 0402 Type				D	±0.5%		
	L	0603型 0603 Type	08			K	±10%	C	塑料袋 散裝 Case
					跨接電阻 Chip Jumper	F	<10mΩ		
						G	<20mΩ		
						J	<50mΩ		

### ■ 結構 Construction



- ① 陶瓷基板 Ceramic Substrate
- ② 背電極 Bottom Electrode
- ③ 面電極 Top Electrode
- ④ 電阻體 Resistor Layer
- ⑤ 一次保護 Primary Overcoat
- ⑥ 二次保護 Secondary Overcoat
- ⑦ 端電極 Edge Electrode
- ⑧ 中間電極 Barrier Layer
- ⑨ 外部電極 External Electrode

**规格尺寸 Dimensions**

RCMT08/RCML08:

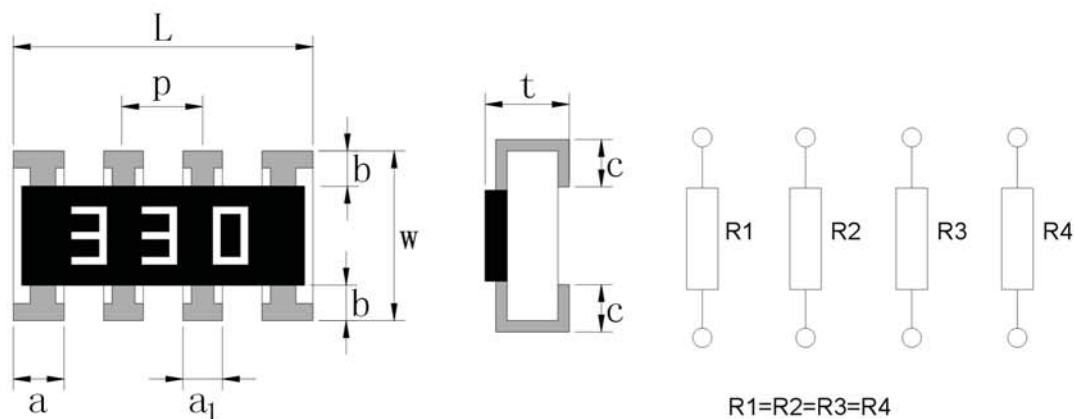

型号 Type	尺寸 Dimensions (mm)							
	L	W	t	p	a	a <sub>1</sub>	b	c
RCMT08	2.00±0.10	1.00±0.10	0.45±0.10	0.50±0.05	0.40±0.10	0.30±0.10	0.15±0.10	0.25±0.10
RCML08	3.20±0.15	1.60±0.15	0.50±0.10	0.80±0.10	0.60±0.10	0.40±0.10	0.30±0.20	0.30±0.15

RCMT04:

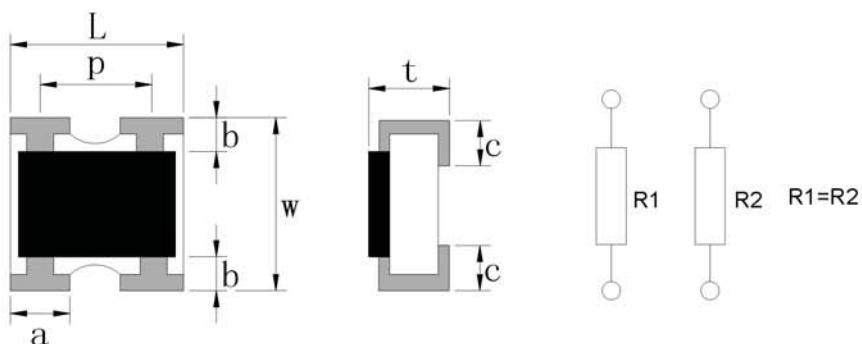

型号 Type	尺寸 Dimensions (mm)						
	L	W	t	p	a	b	c
RCMT04	1.00±0.10	1.00±0.10	0.35±0.10	0.65±0.05	0.35±0.10	0.15±0.10	0.25±0.10

# 厚膜片式網絡電阻器

## Thick Film Chip Network Resistor

### ■ 負荷下降曲線 Derating Curve

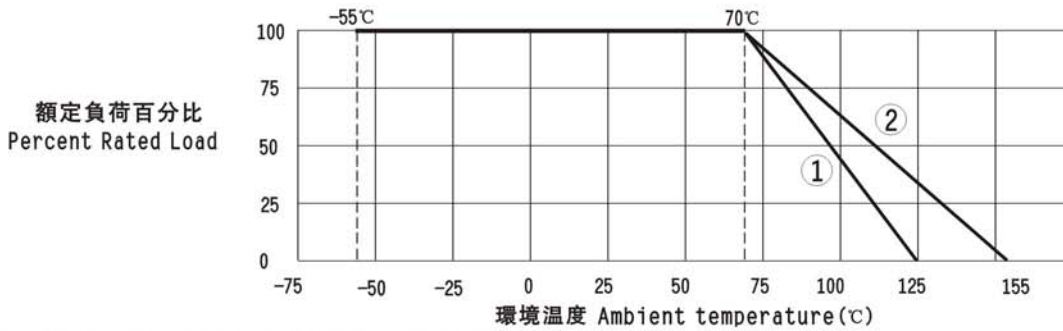

使用溫度範圍:  
 ①Operating Temperature Range: -55°C~125°C  
 ②Operating Temperature Range: -55°C~155°C

注1: 曲線①適用於RCMT04、RCMT08產品; 曲線②適用於RCML08產品。

Note1: RCMT04、RCMT08 product be the same with curve ①; RCML08 be the same with curve ②.

注2: 當電阻使用的環境溫度超過70°C時, 其額定負荷(額定功率或額定電流)按上述曲線下降。

Note2: For resistors operated in ambient over 70°C, rated load (rated power or rated current) shall be derated in accordance with the above figure.

### ■ 額定值 Ratings

型號 Type	70°C下 額定功率 Rated Power at 70°C (W)	元件極限電壓 Limiting Element Voltage (V)	最大過負荷 電壓 Max. Overload Voltage (V)	跨接電阻70°C 下額定電流 Rated Current for Chip Jumper at 70°C (A)	跨接電阻最大 過負荷電流 Max. Overload Current for Chip Jumper (A)	端子 數目 Terminal Numbers	電阻 個數 Resistor Numbers
RCMT04	1/16	50	100	1	2	4	2
RCMT08	1/16	50	100	1	2	8	4
RCML08	1/16	50	100	1	3	8	4
注 Note	1、電壓、電流為直流或交流有效值。 Voltage, current of DC or AC RMS value. 2、 $E = \sqrt{PR}$ 或元件極限電壓兩者中的較小值。 $E = \sqrt{PR}$ or Limiting element voltage whichever is lower. E: 額定電壓 Rated voltage (V) P: 額定功率 Rated power (W) R: 標稱阻值 Normal resistance (Ω)						

型號 Type	阻值範圍 Resistance Range	電阻溫度係數 T.C.R (ppm/°C)
RCMT04 RCMT08	$1\Omega < R < 10\Omega$	± 400
	$10\Omega < R < 1M\Omega$	± 200
	$1M\Omega < R < 10M\Omega$	± 400
RCML08	$1\Omega < R < 10\Omega$	± 250
	$10\Omega < R < 1M\Omega$	± 100
	$1M\Omega < R < 10M\Omega$	± 250

## ■ 特性 Characteristics

項目 Item	標準 Specifications		測試方法 (IEC 60115-1) Test Methods (IEC 60115-1)
	片式電阻器 Resistor	跨接電阻 Jumper	
可焊性 Solderability	可焊面積 > 95% 95% Cover Min	可焊面積 > 95% 95% Cover Min	IEC 60115-1 4.17 245°C ± 5°C 錫槽, 保持 3s ± 0.3s. Lead-free solder bath at 245°C ± 5°C for 3s ± 0.3s.
耐焊接熱 Resistance to Soldering Heat	無可見損傷 No mechanical damage $\Delta R < \pm (1.0\%R + 0.05\Omega)$	無可見損傷 No mechanical damage R < 50 mΩ (J級) R < 20 mΩ (G級) R < 10 mΩ (F級)	IEC 60115-1 4.18 270°C ± 5°C 錫槽, 保持 10s ± 1s. Lead-free solder bath at 270°C ± 5°C for 10s ± 1s.
基板彎曲試驗 Substrate Bending Test	外觀無可見損傷 No mechanical damage $\Delta R < \pm (1.0\%R + 0.05\Omega)$	無可見損傷 No mechanical damage R < 50 mΩ (J級) R < 20 mΩ (G級) R < 10 mΩ (F級)	IEC 60115-1 4.33 彎曲距離 (Bending distance): RCMT04, RCMT08: 5mm; RCML08: 4mm; 保持時間 (Duration): 60s ± 5s.
剪切力試驗 Shear Test	外觀無可見損傷 No mechanical damage	外觀無可見損傷 No mechanical damage	IEC 60115-1 4.32 施加力 (Applying force): 5 N. 保持時間 (Duration): 10s ± 1s.
電阻溫度係數 T.C.R	在規定值內 Within specified T.C.R	/	IEC 60115-1 4.8 +20°C / -55°C / +20°C / +125°C / +20°C
溫度快速變化 Rapid Change of Temperature	無可見損傷 No mechanical damage $\Delta R < \pm (1.0\%R + 0.05\Omega)$	無可見損傷 No mechanical damage R < 50 mΩ (J級) R < 20 mΩ (G級) R < 10 mΩ (F級)	IEC 60115-1 4.19 RCMT04, RCMT08: -55°C (30分鐘) ~ 常溫 (5分鐘) ~ 125°C (30分鐘), 300個循環。 RCMT04, RCMT08: -55°C (30min) ~ normal temperature (5min) ~ 125°C (30min), 300 cycles. RCML08: -55°C (30分鐘) ~ 常溫 (5分鐘) ~ 155°C (30分鐘), 300個循環。 RCML08: -55°C (30min) ~ normal temperature (5min) ~ 155°C (30min), 300 cycles.
短時間過負載 Short Time Overload	無可見損傷 No mechanical damage 0.5%、1%: $\Delta R < \pm (1.0\%R + 0.05\Omega)$ 2%、5%、10%: $\Delta R < \pm (2.0\%R + 0.05\Omega)$	無可見損傷 No mechanical damage R < 50 mΩ (J級) R < 20 mΩ (G級) R < 10 mΩ (F級)	IEC 60115-1 4.13 2.5倍額定電壓或最大過負荷電壓/電流 (取最小值), 持續 5秒。 2.5 times rated voltage or max. overload voltage (current) whichever is lower for 5s.
斷續過負載 Periodic Pulse Overload Test	無可見損傷 No mechanical damage $\Delta R < \pm (5.0\%R + 0.05\Omega)$	無可見損傷 No mechanical damage R < 50 mΩ (J級) R < 20 mΩ (G級) R < 10 mΩ (F級)	IEC 60115-1 4.39 2.5倍額定電壓或最大過負荷電壓/電流 (取最小值), 通 1秒 / 斷 25秒, 10000個循環。 2.5 times rated voltage or max. overload voltage (current) whichever is lower for 1s ON / 25s OFF, 10000 cycles.
穩態濕熱 Damp Heat, Steady State	無可見損傷 No mechanical damage $\Delta R < \pm (3.0\%R + 0.05\Omega)$	無可見損傷 No mechanical damage R < 100 mΩ (J級) R < 40 mΩ (G級) R < 20 mΩ (F級)	IEC 60115-1 4.24 40°C ± 2°C, 93% ± 3%RH, 1000h, 額定電壓 (電流) 或元件極限電壓 (取較小值) 通 1.5小時 / 斷 0.5小時。 40°C ± 2°C, 93% ± 3%RH, 1000h, rated voltage (current) or limiting element voltage whichever is lower for 1.5h ON / 0.5h OFF.
70°C 耐久性 Endurance at 70°C	無可見損傷 No mechanical damage 0.5%、1%: $\Delta R < \pm (1.0\%R + 0.05\Omega)$ 2%、5%、10%: $\Delta R < \pm (2.0\%R + 0.05\Omega)$	無可見損傷 No mechanical damage R < 100 mΩ (J級) R < 40 mΩ (G級) R < 20 mΩ (F級)	IEC 60115-1 4.25.1 70°C ± 2°C, 1000h, 額定電壓 (電流) 或元件極限電壓 (取較小值) 通 1.5小時 / 斷 0.5小時。 70°C ± 2°C, 1000h, rated voltage (current) or limiting element voltage whichever is lower for 1.5h ON / 0.5h OFF.

# 厚膜片式網絡電阻器

## Thick Film Chip Network Resistor

### ■ 特性 Characteristics

( 續上頁 Continue)

項目 Item	標準 Specifications		測試方法 (IEC 60115-1) Test Methods (IEC 60115-1)
	片式電阻器 Resistor	跨接電阻 Jumper	
上限類別溫度 耐久性 Endurance at Upper Temperature	無可見損傷 No mechanical damage 0.5%、1%: $\Delta R < \pm (1.0\%R + 0.05\Omega)$ 2%、5%、10%: $\Delta R < \pm (2.0\%R + 0.05\Omega)$	無可見損傷 No mechanical damage $R < 100 \text{ m}\Omega$ (J級) $R < 40 \text{ m}\Omega$ (G級) $R < 20 \text{ m}\Omega$ (F級)	IEC 60115-1 4.25.3 RCMT04、RCMT08: $125^\circ\text{C} \pm 2^\circ\text{C}$ , 1000h. RCML08: $155^\circ\text{C} \pm 2^\circ\text{C}$ , 1000h.
低溫負載 Operation at Low Temperature	無可見損傷 No mechanical damage 0.5%、1%: $\Delta R < \pm (1.0\%R + 0.05\Omega)$ 2%、5%、10%: $\Delta R < \pm (2.0\%R + 0.05\Omega)$	無可見損傷 No mechanical damage $R < 50 \text{ m}\Omega$ (J級) $R < 20 \text{ m}\Omega$ (G級) $R < 10 \text{ m}\Omega$ (F級)	IEC 60115-1 4.36 $-55^\circ\text{C} \pm 5^\circ\text{C}$ , 無負載1小時, 額定電壓(電流)或元件極限電壓 (取較小值)45分鐘, 無負載15分鐘。 $-55^\circ\text{C} \pm 5^\circ\text{C}$ , 1h without load, rated voltage(current) or limiting element voltage whichever is lower for 45min, 15 min without load.
絕緣電阻 Insulation Resistance	1000M $\Omega$ Min	1000M $\Omega$ Min	IEC 60115-1 4.6 在電極與基片間施加100V $\pm$ 15V直流電壓, 保持1分鐘, 然後 測絕緣電阻值。 Apply DC 100V $\pm$ 15V between substrate and terminations for 1 min, then check insulation resistance.
耐電壓 Voltage Proof	無擊穿或飛弧 No breakdown or flashover	無擊穿或飛弧 No breakdown or flashover	IEC 60115-1 4.7 在電極與基片間以大約100V/s的速率施加有效值為最大過負 荷電壓的交流電壓, 保持60s $\pm$ 5s。 Apply max. overload voltage of AC RMS at a rate of approximately 100V/s between substrate and terminations for 60s $\pm$ 5s.
耐溶劑 Component Solvent Resistance	無可見損傷 No mechanical damage $\Delta R < \pm (1.0\%R + 0.05\Omega)$	無可見損傷 No mechanical damage $R < 50 \text{ m}\Omega$ (J級) $R < 20 \text{ m}\Omega$ (G級) $R < 10 \text{ m}\Omega$ (F級)	IEC 60115-1 4.29 異丙醇(IPA), $23^\circ\text{C} \pm 5^\circ\text{C}$ , 浸10小時。 Iso-propyl alcohol (IPA), $23^\circ\text{C} \pm 5^\circ\text{C}$ , 10h.

### ■ 包裝 Packaging

包裝方式見附錄 Packaging see the appendix.

## 附錄 Appendix

### ■ 推薦焊盤尺寸 Recommend Solder Pad Size

#### ● 片式固定電阻器 Chip fixed resistor

單位 unit: mm

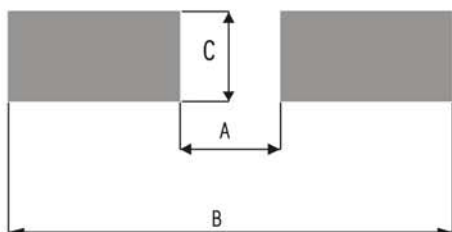

型號 Type	A	B	C
01005	0.17	0.60	0.22
0201	0.23	0.84	0.38
0402	0.45	1.45	0.60
0603	0.80	2.50	0.95
0805	1.05	3.25	1.40
1206	1.90	4.50	1.75
1210	2.00	4.60	2.70
2010	3.50	6.50	2.70
2512	4.80	7.80	3.40

#### ● 厚膜片式網絡電阻器 Thick film chip network resistor

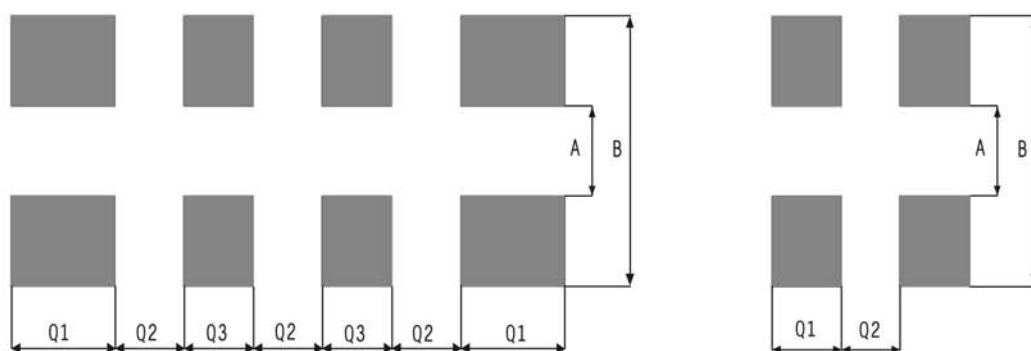

單位 unit: mm

型號 Type	A	B	Q1	Q2	Q3
RCMT04	0.50	1.50	0.35	0.30	/
RCMT08	0.38	1.60	0.40	0.20	0.30
RCML08	0.80	2.70	0.60	0.40	0.40

## ■ 包裝 Packaging

### ● 紙帶編帶 Paper Taping

適用於01005、0201、0402、RCMT04、RCMT08：  
For 01005、0201、0402、RCMT04、RCMT08：

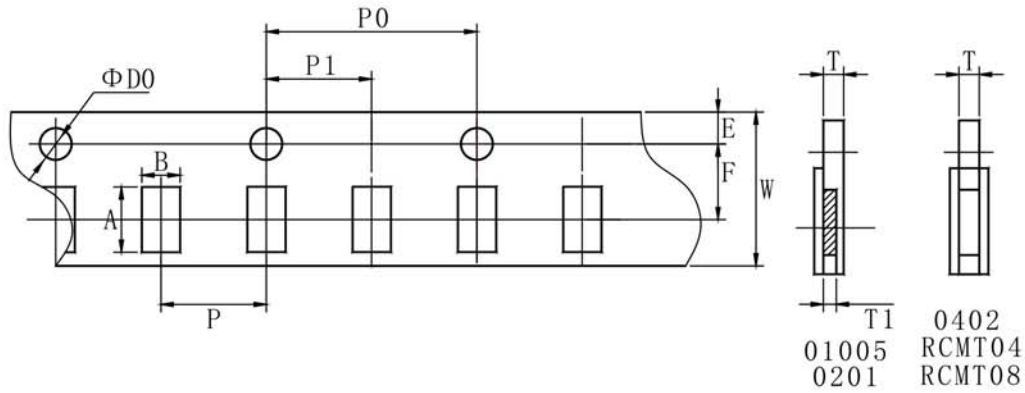

單位 unit: mm

型號 Type	A	B	W	F	E
01005	0.45±0.02	0.25±0.02	8.00±0.02	3.50±0.05	1.75±0.05
0201	0.70±0.10	0.40±0.10	8.00±0.20	3.50±0.05	1.75±0.10
0402	1.20±0.10	0.70±0.10	8.00±0.20	3.50±0.05	1.75±0.10
RCMT04	1.20±0.10	1.20±0.10	8.00±0.20	3.50±0.05	1.75±0.10
RCMT08	2.20±0.10	1.20±0.10	8.00±0.20	3.50±0.05	1.75±0.10

單位 unit: mm

型號 Type	P	P0	P1	ΦD0	T1	T
01005	2.00±0.05	4.00±0.10	2.00±0.05	1.55±0.02	0.17±0.02	0.31±0.02
0201	2.00±0.05	4.00±0.10	2.00±0.05	1.50±0.10	0.28±0.04	0.42±0.05
0402	2.00±0.05	4.00±0.10	2.00±0.05	1.50±0.10	/	0.42±0.05
RCMT04	2.00±0.10	4.00±0.10	2.00±0.05	1.50±0.10	/	0.42±0.05
RCMT08	2.00±0.10	4.00±0.10	2.00±0.05	1.50±0.10	/	0.60±0.10

適用於0603、0805、1206、1210、RCML08：  
For 0603、0805、1206、1210、RCML08：

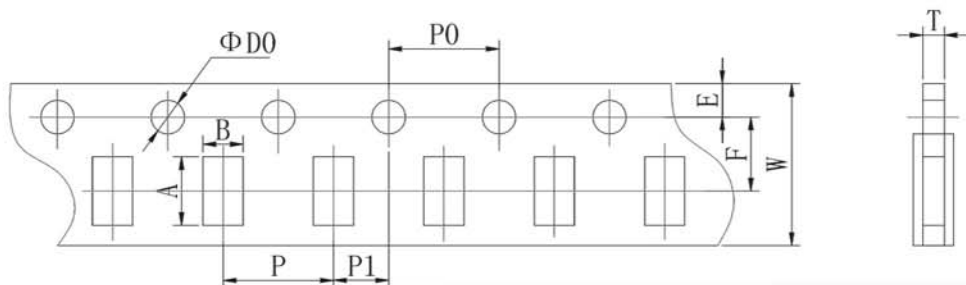

## 附錄 Appendix

單位 unit: mm

型號 Type	A	B	W	F	E
0603	1.85±0.10	1.10±0.10	8.00±0.20	3.50±0.05	1.75±0.10
0805	2.35±0.10	1.65±0.10	8.00±0.20	3.50±0.05	1.75±0.10
1206	3.50±0.20	1.90±0.20	8.00±0.20	3.50±0.05	1.75±0.10
1210	3.50±0.20	2.80±0.20	8.00±0.20	3.50±0.05	1.75±0.10
RCML08	3.50±0.20	1.90±0.20	8.00±0.20	3.50±0.05	1.75±0.10

單位 unit: mm

型號 Type	P	P0	P1	ΦD0	T
0603	4.00±0.10	4.00±0.10	2.00±0.05	1.50±0.10	0.60±0.10
0805	4.00±0.10	4.00±0.10	2.00±0.05	1.50±0.10	0.75±0.10
1206	4.00±0.10	4.00±0.10	2.00±0.05	1.50±0.10	0.75±0.10
1210	4.00±0.10	4.00±0.10	2.00±0.05	1.50±0.10	0.75±0.10
RCML08	4.00±0.10	4.00±0.10	2.00±0.05	1.50±0.10	0.75±0.10

● 塑料帶編帶 Embossed Taping  
適用於2010、2512:  
For 2010、2512:

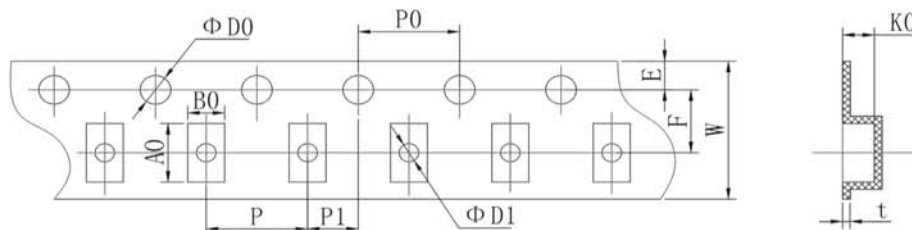

單位 unit: mm

型號 Type	A0	B0	W	F	E	t
2010	5.45±0.10	2.77±0.10	12.00±0.10	5.50±0.10	1.75±0.10	0.24±0.05
2512	6.73±0.10	3.40±0.10	12.00±0.10	5.50±0.10	1.75±0.10	0.24±0.05

單位 unit: mm

型號 Type	P	P0	P1	ΦD0	ΦD1	K0
2010	4.00±0.10	4.00±0.10	2.00±0.05	1.50+0.10/-0	1.50±0.10	0.84±0.10
2512	4.00±0.10	4.00±0.10	2.00±0.05	1.50+0.10/-0	1.50±0.10	0.81±0.10



● 卷盤 Reel



單位 unit: mm

型號 Type	M	W	T	A	B	C	D
01005、0201 0402、0603 0805、1206 1210、RCMT04 RCMT08、RCML08	178±2.0	9.5±1.0	12.5±1.5	2.0±0.5	13.0±0.5	21.0±0.5	58.0±2.0
2010、2512	178±2.0	13.0±0.5	15.5±1.5	2.0±0.5	13.0±0.5	21.0±0.5	57.0±2.0

● 包裝數量 Packaging Quantity

包裝方法 Packaging style	編帶 Tape & reel				塑料袋散裝 Case		
型號 Type	01005	0201、0402 RCMT04 RCMT08	0603、0805 1206、1210 RCML08	2010 2512	01005 0201 0402	0603、0805 1206 RCMT04、RCMT08 RCML08	1210 2010 2512
數量 Quantity(pcs)	20000	10000	5000	4000	<50000	<10000	<4000

■ IEC E-24、E-96系列電阻值代碼對照表

IEC E-24、E-96 Series Resistance Cross-reference List

● E-24 系列 E-24 series (×10<sup>n</sup>Ω)

(單位 unit: 0.001Ω、0.01Ω、0.1Ω、1Ω、10Ω、100Ω、1kΩ、10kΩ、100kΩ、1MΩ、10MΩ、100MΩ、1000MΩ)

1.0	1.5	2.2	3.3	4.7	6.8
1.1	1.6	2.4	3.6	5.1	7.5
1.2	1.8	2.7	3.9	5.6	8.2
1.3	2.0	3.0	4.3	6.2	9.1

# 附錄

## Appendix

● E-96系列 E-96 series ( $\times 10^n \Omega$ )

(單位unit: 0.001 $\Omega$ 、0.01 $\Omega$ 、0.1 $\Omega$ 、1 $\Omega$ 、10 $\Omega$ 、100 $\Omega$ 、1k $\Omega$ 、10k $\Omega$ 、100k $\Omega$ 、1M $\Omega$ 、10M $\Omega$ 、100M $\Omega$ 、1000M $\Omega$ )

1.00	1.33	1.78	2.37	3.16	4.22	5.62	7.50
1.02	1.37	1.82	2.43	3.24	4.32	5.76	7.68
1.05	1.40	1.87	2.49	3.32	4.42	5.90	7.87
1.07	1.43	1.91	2.55	3.40	4.53	6.04	8.06
1.10	1.47	1.96	2.61	3.48	4.64	6.19	8.25
1.13	1.50	2.00	2.67	3.57	4.75	6.34	8.45
1.15	1.54	2.05	2.74	3.65	4.87	6.49	8.66
1.18	1.58	2.10	2.80	3.74	4.99	6.65	8.87
1.21	1.62	2.15	2.87	3.83	5.11	6.81	9.09
1.24	1.65	2.21	2.94	3.92	5.23	6.98	9.31
1.27	1.69	2.26	3.01	4.02	5.36	7.15	9.53
1.30	1.74	2.32	3.09	4.12	5.49	7.32	9.76

● E-96系列0603型號《乘數代碼對照表》及《電阻值代碼對照表》

E-96 series (0603) 《multiplied Cross-reference List》 And 《Resistance Cross-reference List》

乘數multiplied	$\times 10^0$	$\times 10^1$	$\times 10^2$	$\times 10^3$	$\times 10^4$	$\times 10^5$	$\times 10^6$	$\times 10^7$	$\times 10^{-1}$	$\times 10^{-2}$	$\times 10^{-3}$
代碼 code	A	B	C	D	E	F	G	H	X	Y	Z

代號 Code	E-96系列電阻 E-96 resistance	代號 Code	E-96系列電阻 E-96 resistance	代號 Code	E-96系列電阻 E-96 resistance	代號 Code	E-96系列電阻 E-96 resistance
01	100	25	178	49	316	73	562
02	102	26	182	50	324	74	576
03	105	27	187	51	332	75	590
04	107	28	191	52	340	76	604
05	110	29	196	53	348	77	619
06	113	30	200	54	357	78	634
07	115	31	205	55	365	79	649
08	118	32	210	56	374	80	665
09	121	33	215	57	383	81	681
10	124	34	221	58	392	82	698
11	127	35	226	59	402	83	715
12	130	36	232	60	412	84	732
13	133	37	237	61	422	85	750
14	137	38	243	62	432	86	768
15	140	39	249	63	442	87	787
16	143	40	255	64	453	88	806
17	147	41	261	65	464	89	825
18	150	42	267	66	475	90	845
19	154	43	274	67	487	91	866
20	158	44	280	68	499	92	887
21	162	45	287	69	511	93	909
22	165	46	294	70	523	94	931
23	169	47	301	71	536	95	953
24	174	48	309	72	549	96	976

## ■ 片式電阻器使用說明 Chip Resistor Instructions for Use

### ● 本產品在以下特殊環境下應用，性能可能會受到影響：

- 1、在各種類型的液體，包括水、油、化學品、有機溶劑的使用。
- 2、在戶外直接暴露在陽光的地方，或在灰塵多的地方使用。
- 3、在產品暴露的地方，有海風或腐蝕性氣體，包括氯氣、硫化氫、氨氣、二氧化硫、二氧化氮。
- 4、在產品暴露于靜電或電磁波的地方使用。
- 5、在產生熱量的部件、塑料綫，或其他易燃物品附近使用。
- 6、在用樹脂或其他塗層材料密封產品的情況下使用。
- 7、焊接后使用不潔焊料或使用水或水溶性清洗劑清洗產品。

### ● Application of the products in a special environment can deteriorate product performance:

- 1、Use in various types of liquid, including water, oils, chemicals, and organic solvents.
- 2、Use outdoors where the products are exposed to direct sunlight, or in dusty places.
- 3、Use in places where the products are exposed to sea winds or corrosive gases, including Cl<sub>2</sub>, H<sub>2</sub>S, NH<sub>3</sub>, SO<sub>2</sub>, and NO<sub>2</sub>.
- 4、Use in places where the products are exposed to static electricity or electromagnetic waves.
- 5、Use in proximity to heat-producing components, plastic cords, or other flammable items.
- 6、Use involving sealing or coating the products with resin or other coating materials.
- 7、Use involving unclean solder or use of water or water-soluble cleaning agents for cleaning after soldering.

### ● 產品使用注意事項

- 1、避免采用超過正常額定功率的功率，超過額定功率的穩態負載條件下可能會對產品性能和可靠性產生負面影響。
- 2、用鑷子拿起產品時要小心，有可能會將保護或電阻體夾碎。
- 3、手動安裝產品時，烙鐵頭勿觸碰產品。
- 4、貯存條件：溫度5℃~30℃，相對濕度30%~70%。

### ● Precautions on use of products

- 1、Avoid applying power exceeding normal rated power, exceeding the power rating under steady-state loading condition may negatively affect product performance and reliability.
- 2、Be careful when pick up the products with tweezers. There may be a care that the overcoat and / or the body can be chipped.
- 3、Soldering tip shall not touch the product when install product manually.
- 4、Storage conditions: T: 5℃~30℃, RH: 30%~70%.

## ■ 焊接 Soldering

### ● 推薦的回流焊曲綫 Recommended reflow profile



### ● 推薦的波峰焊曲綫 Recommended wave solder profile

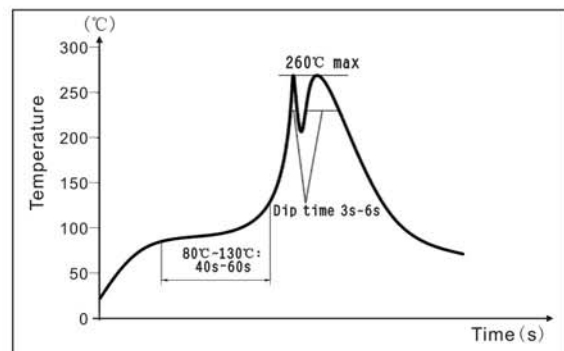

### ● 推薦的焊膏類型 Recommended solder alloy: 96.5Sn/3.0Ag/0.5Cu