

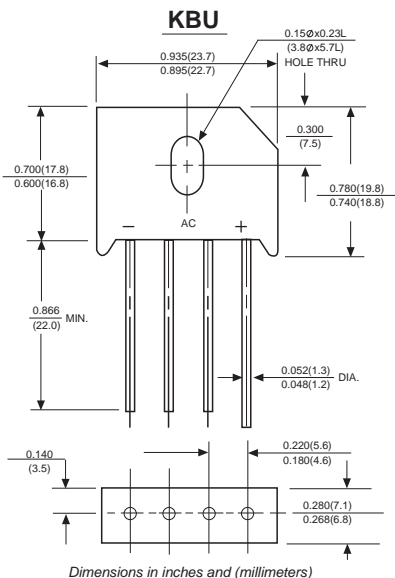

KBU8005 THRU KBU810

SILICON BRIDGE RECTIFIERS

Reverse Voltage - 50 to 1000 Volts Forward Current -8.0 Amperes



FEATURES

- ◆ The plastic package carries Underwriters Laboratory Flammability Classification 94V-0
- ◆ Ideal for printed circuit boards
- ◆ Low reverse leakage
- ◆ High forward surge current capability
- ◆ High temperature soldering guaranteed:
260°C/10 seconds, 0.375" (9.5mm) lead length, 5 lbs. (2.3kg) tension

MECHANICAL DATA

Case: Molded plastic body

Terminals: Plated leads solderable per MIL-STD-750, Method 2026

Polarity: Polarity symbols marked on case

Mounting: Thru hole for #6 serew, 5in.-lbs. torque max.

Weight: 0.27 ounce, 7.59 grams

MAXIMUM RATINGS AND ELECTRICAL CHARACTERISTICS

Ratings at 25°C ambient temperature unless otherwise specified.

Single phase half-wave 60Hz, resistive or inductive load, for capacitive load current derate by 20%.

MDD Catalog Number	SYMBOLS	KBU 8005	KBU 801	KBU 802	KBU 804	KBU 806	KBU 808	KBU 810	UNITS
Maximum repetitive peak reverse voltage	V_{RRM}	50	100	200	400	600	800	1000	VOLTS
Maximum RMS voltage	V_{RMS}	35	70	140	280	420	560	700	VOLTS
Maximum DC blocking voltage	V_{DC}	50	100	200	400	600	800	1000	VOLTS
Maximum Average Forward (with heatsink Note 1) Rectified Current @ $T_c=100^\circ\text{C}$ (without heatsink)	$I_{(AV)}$	8.0							Amps
Peak forward surge current 8.3ms single half sine-wave superimposed on rated load (JEDEC Method)	I_{FSM}	200.0							Amps
Maximum instantaneous forward voltage drop per bridge element at 4.0A	V_F	1.0							Volts
Maximum DC reverse current at rated DC blocking voltage	I_R	$T_A=25^\circ\text{C}$							μA
		$T_A=125^\circ\text{C}$							mA
Typical Junction Capacitance (Note 1)	C_J	200							pF
Typical Thermal Resistance (Note 2)	$R_{\theta JA}$	5.0							$^\circ\text{C}/\text{W}$
Operating junction temperature range	T_J	-55 to +150							$^\circ\text{C}$
storage temperature range	T_{STG}	-55 to +150							$^\circ\text{C}$

NOTES:

1. Device mounted on 100mm*100mm*1.6mm Cu plate heatsink



RATINGS AND CHARACTERISTIC CURVES KBU8005 THRU KBU810

AVERAGE FORWARD RECTIFIED CURRENT, AMPERES

FIG. 1- FORWARD CURRENT DERATING CURVE

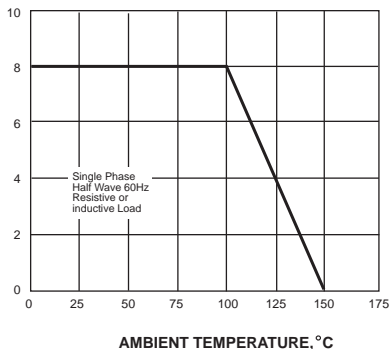

PEAK FORWARD SURGE CURRENT, AMPERES

FIG. 2-MAXIMUM NON-REPETITIVE PEAK FORWARD SURGE CURRENT

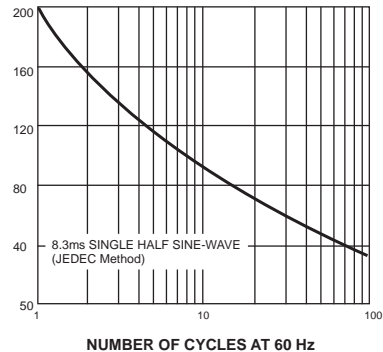

INSTANTANEOUS FORWARD CURRENT, AMPERES

FIG. 3-TYPICAL INSTANTANEOUS FORWARD CHARACTERISTICS

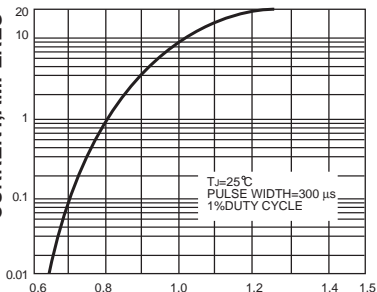

INSTANTANEOUS REVERSE CURRENT, MICROAMPERES

FIG. 4-TYPICAL REVERSE CHARACTERISTICS

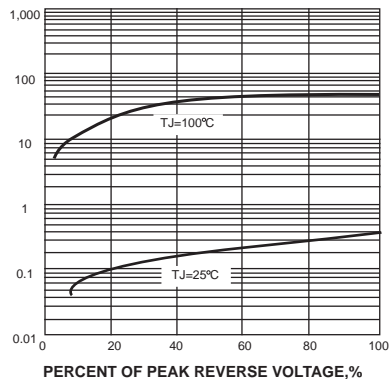

JUNCTION CAPACITANCE, pF

FIG. 5-TYPICAL JUNCTION CAPACITANCE

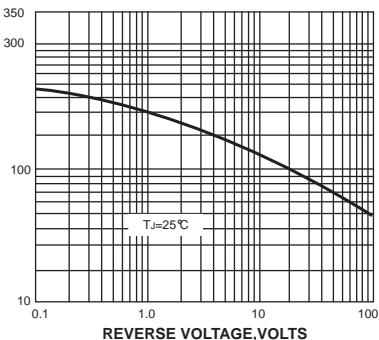

TRANSIENT THERMAL IMPEDANCE, °C/W

FIG. 6-TYPICAL TRANSIENT THERMAL IMPEDANCE

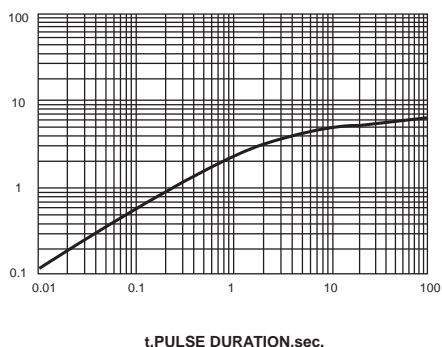

The cruve graph is for reference only, can't be the basis for judgment(曲线图仅供参考!)



www.microdiode.com