

High Power LED Series
3535

LH351H

660nm Deep Red V2

For Horticulture Lighting

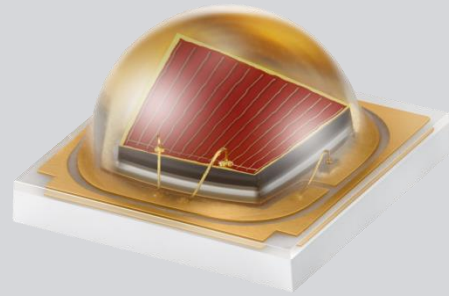

Features & Benefits

- Package : 2pad design with Al₂O₃
- Dimension : 3.5 mm X 3.5 mm
- Maximum current : 1.0 A
- Technology : AlGaInP



Table of Contents

1.	Characteristics	-----	3
2.	Product Code Information	-----	4
3.	Typical Characteristics Graphs	-----	6
4.	Outline Drawing & Dimension	-----	8
5.	Reliability Test Items & Conditions	-----	9
6.	Soldering Conditions	-----	10
7.	Tape & Reel	-----	11
8.	Label Structure	-----	13
9.	Packing Structure	-----	14
10.	Precautions in Handling & Use	-----	16

1. Characteristics

a) Absolute Maximum Rating

Item	Symbol	Rating	Unit	Condition
Ambient / Operating Temperature	T_a	-40 ~ +105	°C	Note 1)*
Storage Temperature	T_{stg}	-40 ~ +105	°C	-
LED Junction Temperature	T_j	125	°C	-
Forward Current (T_j : 25 °C)	I_F	1000	mA	Note 2)*-
Reverse Voltage (@ 10 mA)	V_r	1.1	V	-
Assembly Process Temperature		280 <10	°C s	-
ESD (HBM)	-	±8	kV	-

Notes:

- 1) Refer to the derating curve, '3. Typical Characteristics Graph', for proper driving current that maintained below maximum junction temperature.
- 2) Unpredictable performance may be resulted by driving the product at above Max. I_F . But there will be no damage to the product.

b) Electro-optical Characteristics

Item	Unit	Condition		Value (typ.)
		I_F (mA)	T_j (°C)	
Radiant Power (Φ_E)	mW	700	25	900 ~ 1000
Photosynthetic Photon Flux (PPF)	$\mu\text{mol/s}$	700	25	4.90 ~ 5.43
Forward Voltage (V_F)	V	700	25	2.2
Thermal Resistance (junction to solder point)	°C/W	700	25	3.0
Beam Angle	°	700	25	130
Peak wavelength (λ_p)	nm	700	25	660
Dominant wavelength (λ_D)	nm	700	25	638

Notes:

- 1) Samsung maintains measurement tolerance of: Radiant Power = ±7 %, forward voltage = ±0.1 V, Wavelength = ±2 nm
- 2) Characteristics @ 25 °C are for reference only

2. Product Code Information

1	2	3	4	5	6	7	8	9	10	11	12	13	14	15	16	17	18
S	P	H	R	D	2	L	3	D	H	2	0	E	7	W	4	1	0

Digit	PKG Information	Code	Specification
1 2 3	Samsung Package High Power	SPH	
4 5	Color	RD	Red
6	Product Version	2	
7 8	Product	L3	LH351 Series
9	Lens Type	D	Dome lens
10	Internal Code	H	
11	Wattage	2	2W
12	Sorting Temperature	0	25 °C
13 14	Forward Voltage (V)	E7	2.0 ~ 2.7V
15 16	Wavelength (nm)	W4	650 ~ 670
17 18	Radiant Power (mW)	10	900 ~ 1000

a) Voltage Bins ($I_F = 700 \text{ mA}$, $T_j = 25 \text{ }^\circ\text{C}$)

Product Code	Voltage Rank	Voltage Bin	Voltage Range (V)
SPHRD2L3DH20E7W410	E7	E7	2.0 ~ 2.7

b) Wavelength Bins ($I_F = 700 \text{ mA}$, $T_j = 25 \text{ }^\circ\text{C}$)

Product Code	Wavelength Rank	Wavelength Bin	Wavelength Range (nm)
SPHRD2L3DH20E7W410	W4	W4	650 ~ 670

c) Radiant Power Bins ($I_F = 700 \text{ mA}$, $T_j = 25 \text{ }^\circ\text{C}$)

Product Code	Power Rank	Power Bin	Power Range (mW)
SPHRD2L3DH20E7W410	10	10	900 ~ 1000

3. Typical Characteristics Graphs

a) Spectrum Distribution ($I_F = 700 \text{ mA}$, $T_j = 25 \text{ }^\circ\text{C}$)

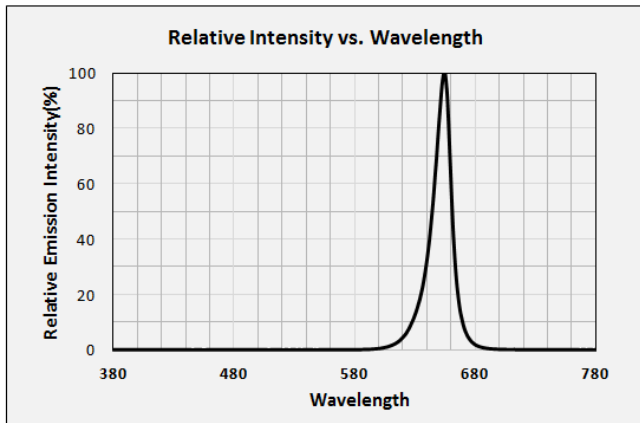

b) Forward Current Characteristics ($T_j = 25 \text{ }^\circ\text{C}$)

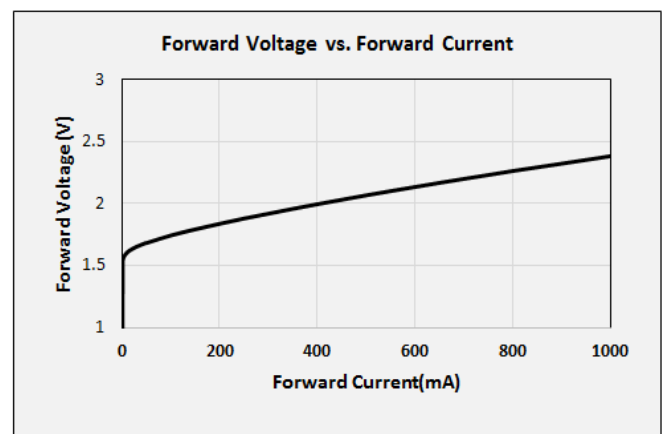
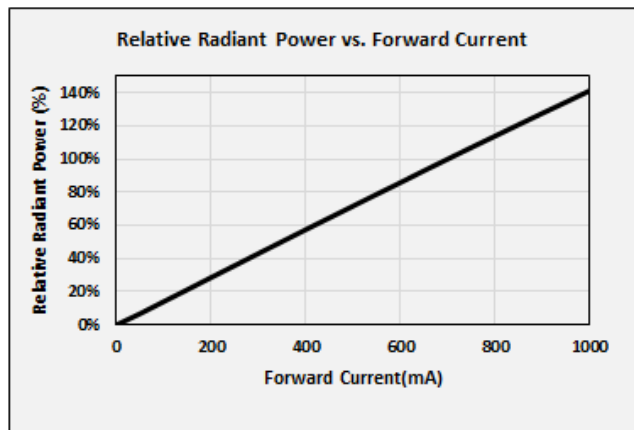

c) Temperature Characteristics ($I_F = 700 \text{ mA}$)

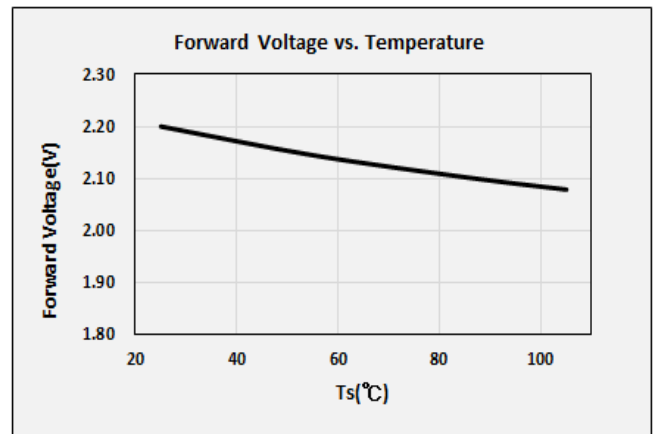
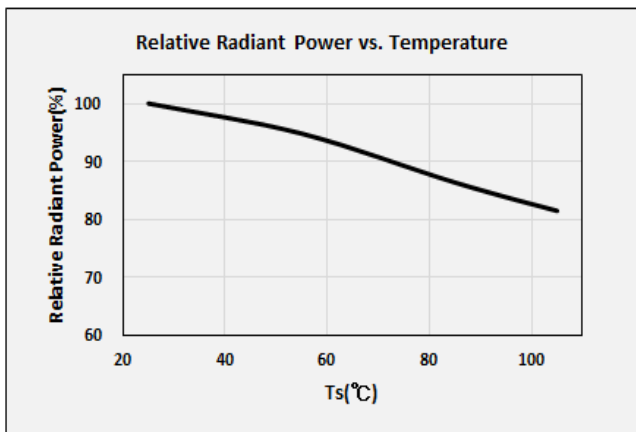

d) Derating Curve and Beam Angle Characteristics ($I_F = 700 \text{ mA}$)

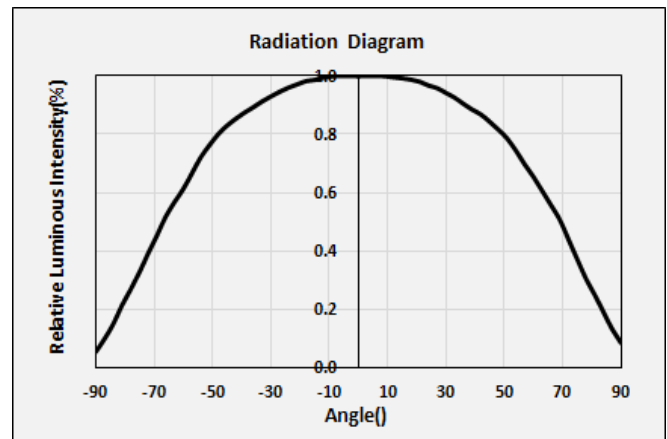
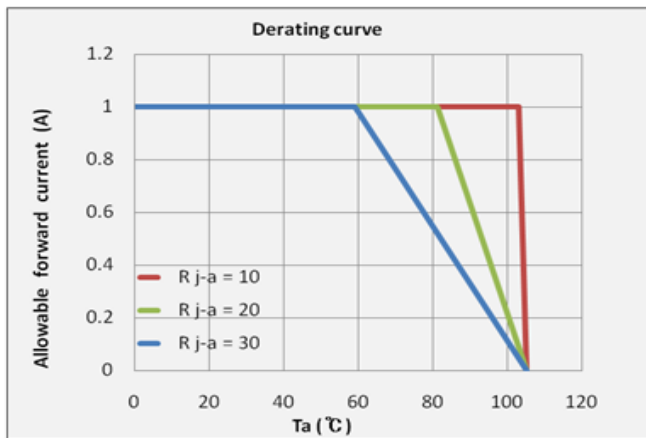

4. Outline Drawing & Dimension

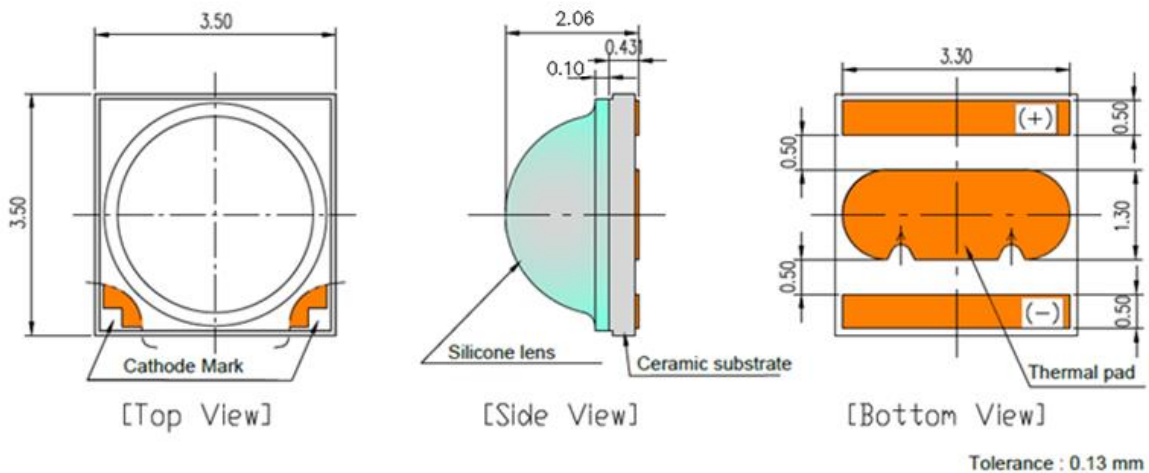

Notes:

- 1) This LED has built-in ESD protection device(s) connected in parallel to LED chip(s).
- 2) The thermal pad is electrically isolated from the anode and cathode contact pads.
- 3) T_s point and measurement method:
 - ① Measure the nearest point to thermal pad as shown above. If necessary, remove PSR of PCB to reach T_s point.
 - ② All pads must be soldered to the PCB to dissipate heat properly, otherwise the LED can be damaged.

Precautions:

- 1) Pressure on the LEDs will influence to the reliability of the LEDs. Precautions should be taken to avoid strong pressure on the LEDs. Do not put stress on the LEDs during heating.
- 2) Re-soldering should not be done after the LEDs have been soldered. If re-soldering is unavoidable, LED's characteristics should be carefully checked before and after such repair.
- 3) Do not stack assembled PCBs together. Since materials of LEDs is soft, abrasion between two PCB assembled with LED might cause catastrophic failure of the LEDs.

5. Reliability Test Items & Conditions

a) Test Items

Test Item	Test Condition	Test Hour / Cycle
High Temperature Life Test	85 °C, Maximum Rated Drive Current	1000 h
High Temperature Humidity Life Test	85 °C, 85 % R.H., Maximum Rated Drive Current	1000 h
Low Temperature Life Test	-40 °C, Maximum Rated Drive Current	1000 h
Temperature Cycling	-45 °C / 15 min ↔ 125 °C / 15 min temperature change within 5 min	500 cycles
High Temperature Storage	105 °C	1000 h
High Temperature Humidity Storage	85 °C, 85 % R.H	1000 h
ESD (HBM)	<p> R₁: 10 MΩ R₂: 1.5 kΩ C: 100 pF V: ±8 kV </p>	5 times

b) Criteria for Judging the Damage

Item	Symbol	Test Condition (T _J = 25 °C)	Limit	
			Min.	Max.
Forward Voltage	V _F	I _F = 700 mA	Init. Value * 0.9	Init. Value * 1.1
Luminous Flux	Φ _v	I _F = 700 mA	Init. Value * 0.7	Init. Value * 1.1

6. Soldering Conditions

a) Reflow Conditions (Pb free)

Reflow frequency: 2 times max.

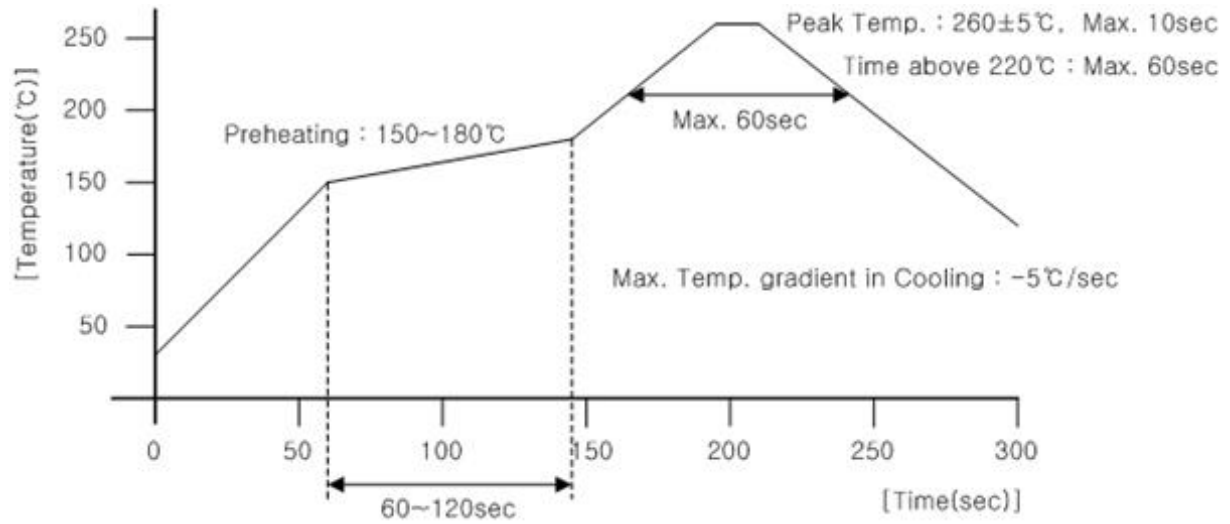

b) Manual Soldering Conditions

Not more than 5 seconds @ max. 300 °C, under soldering iron.

7. Tape & Reel

a) Taping Dimension

(unit: mm)

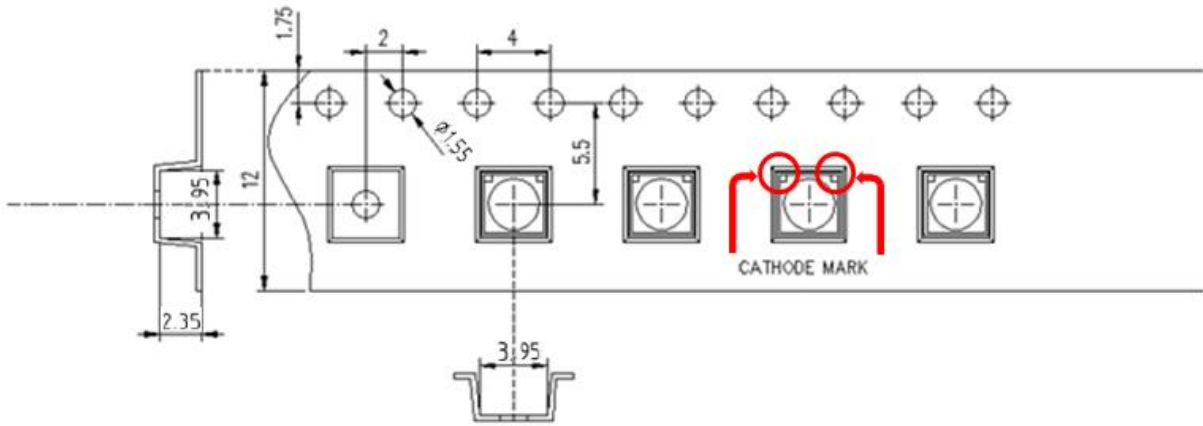

Taping Direction

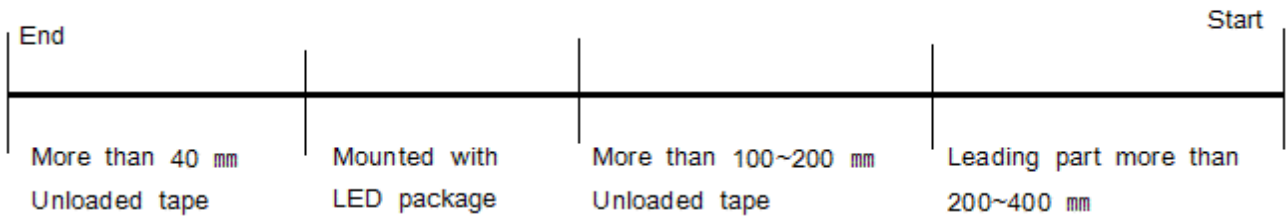

b) Reel Dimension

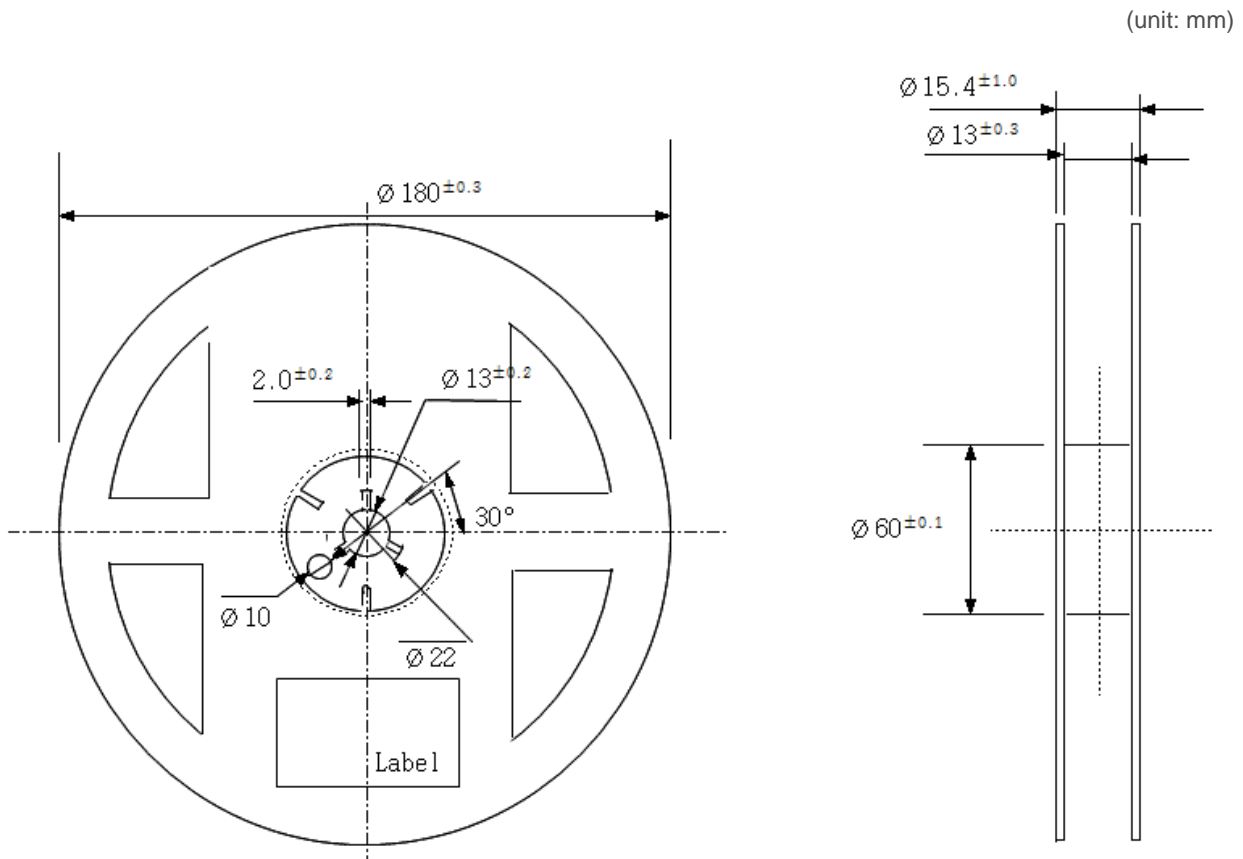
**Notes:**

- 1) Quantity: The quantity/reel is 1,000 pcs
- 2) Cumulative tolerance: Cumulative tolerance / 10 pitches is ± 0.2 mm
- 3) Adhesion strength of cover tape: Adhesion strength is 0.1-0.7 N when the cover tape is turned off from the carrier tape at 10° angle to the carrier tape
- 4) Packaging: P/N, Manufacturing data code no. and quantity are indicated on the aluminum packing bag

8. Label Structure

a) Label Structure

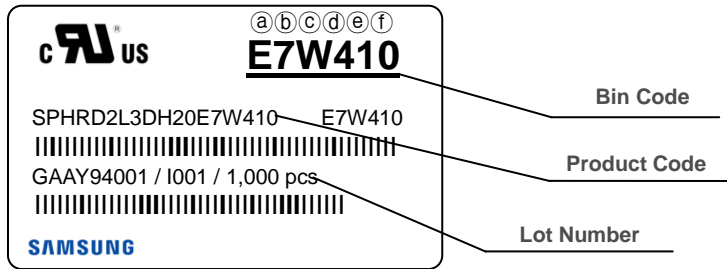

Note: Denoted bin code and product code above is only an example (see description on page 4)

Bin Code:

- ⒶⒷ: Forward Voltage bin (refer to page 5)
- ⒸⒹ: Wavelength bin (refer to page 5)
- ⒺⒻ: Radiant Power bin (refer to page 5)

b) Lot Number

The lot number is composed of the following characters:

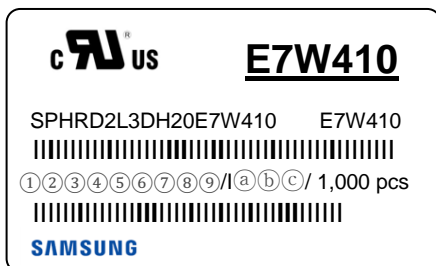

①②③④⑤⑥⑦⑧⑨ / IⒶⒷⒸ / 1,000 pcs

- ①, ② : Production site (G4 : Guangzhou ,China)
- ③ : Product state (A: Normal, B: Bulk, C: First Production, R: Reproduction, S: Sample)
- ④ : Year (D: 2019, E: 2020, F:2021 ...)
- ⑤ : Month (1~9, A, B, C)
- ⑥ : Day (1~9, A, B~V)
- ⑦⑧⑨ : Product serial number (001 ~ 999)
- ⒶⒷⒸ : Reel number (001 ~ 999)

9. Packing Structure

a) Packing Process

Reel

c RU us **E7W410**
 SPHRD2L3DH20E7W410 E7W410
 GAAY94001 / I001 / 1,000 pcs
SAMSUNG

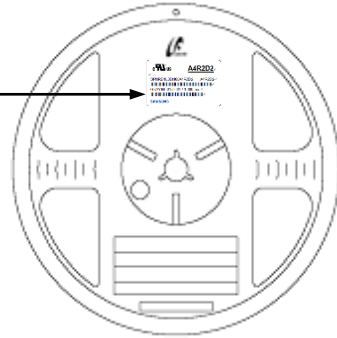
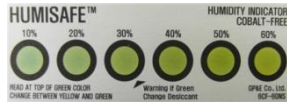

Aluminum Vinyl Packing Bag

c RU us **E7W410**
 SPHRD2L3DH20E7W410 E7W410
 GAAY94001 / I001 / 1,000 pcs
SAMSUNG



Outer Box

Material: Paper SW(B)

Type	Size (mm)			Note
	(a)	(b)	(c)	
7 inch (L)	245 ± 5	220 ± 5	182 ± 5	Up to 8 reels
7 inch (S)	245 ± 5	220 ± 5	86 ± 5	Up to 4 reels

c RU us **E7W410**
 SPHRD2L3DH20E7W410 E7W410
 GAAY94001 / I001 / 8,000 pcs
SAMSUNG

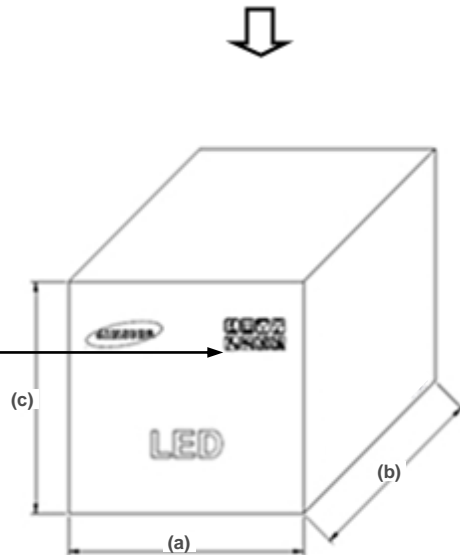

b) Aluminum Vinyl Packing Bag



CAUTION

This bag contains
MOISTURE SENSITIVE DEVICES

LEVEL
2a

cFL ^{us} **E7W410**

SPHRD2L3DH20E7W410 E7W410

GAAY94001 / I001 / 1,000 pcs

SAMSUNG

1. Shelf life in sealed bag: 12 months at <40°C and <90% relative humidity (RH)
2. Peak package body temperature: 240 °C
3. After this bag is opened, devices that will be subjected to reflow solder or other high temperature processes must be:
 - a. Mounted within 672 hours at factory conditions of equal to or less than 30°C /60% RH, or
 - b. Stored at <10% RH
4. Devices require bake, before mounting, if:
 - a. Humidity Indicator Card is >65% when read at 23±5°C, or
 - b. 2a is not met.
5. If baking is required, devices must be baked for 1 hours at 60±5°C

Note: If device containers cannot be subjected to high temperature or shorter bake times are desired, reference IPC/JEDEC J-STD-033 for bake procedure.

Bag seal due date: _____
(if blank, see code label)

Note: Level and body temperature by IPC/JEDEC J-STD-020



ATTENTION

OBSEVE PRECAUTIONS
FOR HANDLING
ELECTROSTATIC
SENSITIVE
DEVICES



주의 사항

이 알루미늄 지퍼 백은 습기 및 정전기로부터 제품을 보호하기 위하여 제작되었습니다. 개봉 후에는 즉시 솔더 작업을 실시하는 것을 권장합니다.

습기 및 정전기로부터 제품을 보호 하기 위해서 개봉 후 사용하지 않는 자재는 본 팩에 넣어 보관 하시기 바랍니다. 사용하지 않는 자재를 본 팩에 넣을 때는 반드시 동봉된 드라이 팩과 함께 넣고 지퍼부분을 완전하게 밀봉하여 주시기 바랍니다.

Important

This Al Zipper bag is designed to protect the enclosed products from moisture and ESD. Once opened, the products should be soldered onto the printed circuit board immediately. When not in use, please do not leave the products unprotected by the Al Zipper Bag. To repack unused products., please ensure the zip-lock is completely sealed with the dry pack left inside.

b) Silica Gel & Humidity Indicator Card inside Aluminum Vinyl Bag

(This image is for reference only. Silicagel and humidity indicator shapes may be different.)

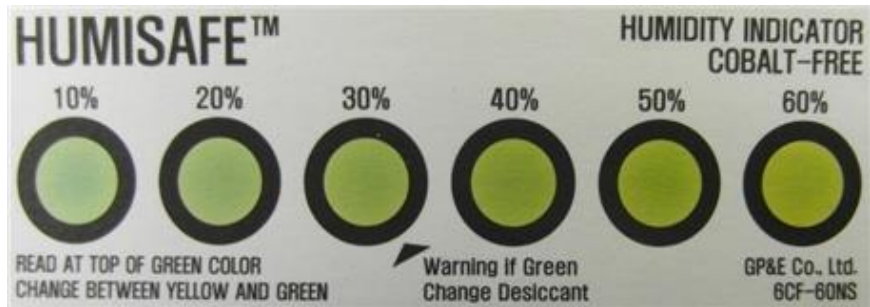

10. Precautions in Handling & Use

- 1) For over-current protection, users are recommended to apply resistors connected in series with the LEDs to mitigate sudden change of the forward current caused by shift of forward voltage.
- 2) This device should not be used in any type of fluid such as water, oil, organic solvent, etc. When cleaning is required, IPA is recommended as the cleaning agent. Some solvent-based cleaning agent may damage the silicone resins used in the device.
- 3) When the device is in operation, the forward current should be carefully determined considering the maximum ambient temperature and corresponding junction temperature.
- 4) LEDs must be stored in a clean environment. If the LEDs are to be stored for three months or more after being shipped from Samsung, they should be packed with a nitrogen-filled container (shelf life of sealed bags is 12 months at temperature 0~40 °C, 0~90 % RH).
- 5) After storage bag is opened, device subjected to soldering, solder reflow, or other high temperature processes must be:
 - a. Mounted within 672 hours (28 days) at an assembly line with a condition of no more than 30 °C / 60 % RH, or
 - b. Stored at <10 % RH
- 6) Repack unused devices with anti-moisture packing, fold to close any opening and then store in a dry place.
- 7) Devices require baking before mounting, if humidity card reading is >60 % at 23 ± 5 °C.
- 8) Devices must be baked for 1 hour at 60 ± 5 °C, if baking is required.
- 9) The LEDs are sensitive to the static electricity and surge current. It is recommended to use a wrist band or anti-electrostatic glove when handling the LEDs. If voltage exceeding the absolute maximum rating is applied to LEDs, it may cause damage or even destruction to LED devices. Damaged LEDs may show some unusual characteristics such as increase in leakage current, lowered turn-on voltage, or abnormal lighting of LEDs at low current.
- 10) VOCs (Volatile Organic Compounds) can be generated from adhesives, flux, hardener or organic additives used in luminaires (fixtures). Transparent LED silicone encapsulant is permeable to those chemicals and they may lead to a discoloration of encapsulant when they exposed to heat or light. This phenomenon can cause a significant loss of light emitted (output) from the luminaires. In order to prevent these problems, we recommend users to know the physical properties of materials used in luminaires and they must be carefully selected.

Legal and additional information.

[About Samsung Electronics Co., Ltd.](#)

Samsung Electronics Co., Ltd. inspires the world and shapes the future with transformative ideas and technologies, redefining the worlds of TVs, smartphones, wearable devices, tablets, cameras, digital appliances, printers, medical equipment, network systems and semiconductors.

We are also leading in the Internet of Things space through, among others, our Digital Health and Smart Home initiatives. We employ 307,000 people across 84 countries. To discover more, please visit our official website at www.samsung.com and our official blog at global.samsungtomorrow.com.

Copyright © 2016 Samsung Electronics Co., Ltd. All rights reserved.
Samsung is a registered trademark of Samsung Electronics Co., Ltd.
Specifications and designs are subject to change without notice. Non-metric weights and measurements are approximate. All data were deemed correct at time of creation. Samsung is not liable for errors or omissions. All brand, product, service names and logos are trademarks and/or registered trademarks of their respective owners and are hereby recognized and acknowledged.

Samsung Electronics Co., Ltd.
1, Samsung ro
Giheung-gu
Yongin-si, Gyeonggi-do, 17113
KOREA

www.samsungled.com