

SNAP DIGITAL OUTPUT MODULES

Features

- > Four channels per module
- > Convenient pluggable wiring terminals; accepts 22 to 14 AWG wire
- > Powered by a single 5-volt supply
- > Channel-specific LEDs
- > Operating temperature: -20 to 70 °C
- > UL and CE approved (most modules); Factory Mutual approved (part numbers ending in FM)



SNAP Digital Output Modules

DESCRIPTION

Opto 22 SNAP I/O digital output modules are part of the SNAP PAC System.

Choose from AC or DC models. Optical isolation on all solid-state modules provides 4,000 volts of transient (4000 V for 1 ms) protection for sensitive control electronics from industrial field signals.

Most SNAP digital modules have removable top-mounted connectors to provide easy access for field wiring. All operate on 5 VDC control logic. Each digital module features integral channel-specific LEDs for convenient troubleshooting and maintenance.

Each module is factory tested twice before shipment, and most modules are UL and CE approved. In addition, part numbers ending in FM are Factory Mutual approved.

SNAP output modules are used to switch up to four separate AC or DC loads. Output modules that are fused use a standard fuse with a convenient handle for easy replacement. DC outputs are available in either a source or sink configuration. AC outputs are zero voltage turn on and zero current turn off for transient-free switching.

SNAP-OAC5MA and SNAP-ODC5MA are special modules featuring manual-on/manual-off/automatic switches, ideal for diagnostic testing of control applications. The switches override output from the application, so you can quickly check field device wiring. These modules each contain four isolated channels.

The SNAP-OAC5-i, SNAP-ODC5-i, and SNAP-ODC5A-i modules provide four isolated output channels.

Part Numbers

Part	Description	See pages
SNAP-OAC5	SNAP 4-channel 12–250 VAC output, 5 VDC logic	3, 5
SNAP-OAC5MA	SNAP 4-channel isolated 12–250 VAC output, 5 VDC logic with manual/auto switches	3, 6
SNAP-OAC5FM	SNAP 4-channel 12–250 VAC output, 5 VDC logic	4, 5
SNAP-OAC5-i	SNAP 4-channel isolated 12–250 VAC output, 5 VDC logic	3, 7
SNAP-OAC5-iFM	SNAP 4-channel isolated 12–250 VAC output, 5 VDC logic	4, 7
SNAP-ODC5SRC	SNAP 4-channel 5–60 VDC output, 5 VDC logic source	8, 12
SNAP-ODC5SRCFM	SNAP 4-channel 5–60 VDC output, 5 VDC logic source	10, 12
SNAP-ODC5SNK	SNAP 4-channel 5–60 VDC output, 5 VDC logic sink	8, 13
SNAP-ODC5SNKFM	SNAP 4-channel 5–60 VDC output, 5 VDC logic sink	10, 13
SNAP-ODC5ASNK	SNAP 4-channel 5–200 VDC output, 5 VDC logic sink	9, 13
SNAP-ODC5MA	SNAP 4-channel isolated 5–60 VDC output, 5 VDC logic with manual/auto switches	9, 14
SNAP-ODC5-i	SNAP 4-channel isolated 5–60 VDC output, 5 VDC logic	9, 15
SNAP-ODC5-iFM	SNAP 4-channel isolated 5–60 VDC output, 5 VDC logic	11, 15
SNAP-ODC5A-i	SNAP 4-channel isolated 5–200 VDC output, 5 VDC logic	9, 15
SNAP-ODC5A-iFM	SNAP 4-channel isolated 5–200 VDC output, 5 VDC logic	11, 15
SNAP-RETN4	SNAP 4-module retention rail (OEM)	-----
SNAP-RETN4B	SNAP 4-module retention rail, 25-pack (OEM)	-----
SNAP-RETN6	SNAP 6-module retention rail (OEM)	-----
SNAP-RETN6B	SNAP 6-module retention rail, 25-pack (OEM)	-----
SNAP-FUSE4AB	SNAP 4-amp fuse, 25-pack	-----
SNAP-MODFUSEH	SNAP digital output module fuse holder, 10-pack	-----

For Ethernet-based applications requiring higher density of digital I/O points, see Opto 22 form #1556, the *SNAP High-Density Digital Module Data Sheet*.

I/O Processor Compatibility

SNAP digital output modules are compatible with all SNAP PAC brains and rack-mounted controllers, including both standard wired models and Wired+Wireless™ models.

Notes for legacy hardware: SNAP digital output modules are also compatible with SNAP Ultimate, SNAP Ethernet, and SNAP Simple brains, as well as other SNAP brains such as the serial B3000 and the B3000HA. These modules can also be used on B-series and M-series mounting racks.

INSTALLATION

The following diagram shows part of a SNAP mounting rack. The rack is shown without screw connectors.

Modules snap securely into place in the row of connectors on the rack. Each module connector has a number. Digital output modules and other types of SNAP I/O modules are mounted on the module connectors starting at module position zero.

NOTE: Check the data sheet or user's guide for the brain or on-the-rack controller you are using to determine module features available and any restrictions on module placement.

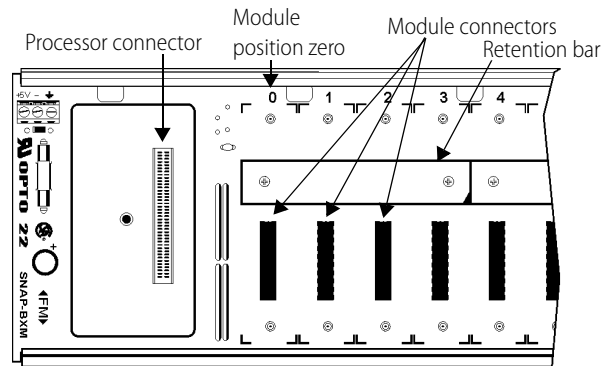

1. Place the rack so that the module connector numbers are right-side up, with zero on the left, as shown in the diagram above. (If your rack has screw connectors, the screw connectors will be at the bottom.)
2. Position the module over the module connector, aligning the small slot at the base of the module with the retention bar on the rack. When positioning modules next to each other, be sure to align the male and female module keys at the tops of the modules before snapping a module into position.
3. With the module correctly aligned, push on the module to snap it into place.
4. Use standard 4-40 x 1/2 truss-head Phillips hold-down screws to secure both sides of each module.
CAUTION: Do not over-tighten screws. See Specifications.
5. Follow the wiring diagrams beginning on [page 5](#) to attach modules to the devices they monitor.

Modules require a special tool (provided) for removal.

SPECIFICATIONS—AC MODULES

	SNAP-OAC5	SNAP-OAC5MA	SNAP-OAC5-I
Key Feature	--	Diagnostic switches Four isolated channels	Four isolated channels
Torque, hold-down screws	4 in-lb (0.45 N-m)	4 in-lb (0.45 N-m)	4 in-lb (0.45 N-m)
Torque, connector screws	5.26 in-lb (0.6 N-m)	5.26 in-lb (0.6 N-m)	5.26 in-lb (0.6 N-m)
Field Side Ratings (each channel)			
Line Voltage - Range	12–250 VAC	12–250 VAC	12–250 VAC
Line Voltage - Nominal	120/240 VAC	120/240 VAC	120/240 VAC
Current Rating 0 °C to 70 °C Ambient	3 amps per module	3 amps per module	3 amps per module
One Cycle Surge	80 amps peak (50/60 Hz)	80 amps peak (50/60 Hz)	80 amps peak (50/60 Hz)
Minimum Load Current	20 mA	20 mA	20 mA
Output Voltage Drop	1.6 volts max. @ 0.75 amps	1.6 volts max. @ 0.75 amps	1.6 volts max. @ 0.75 amps
Off-state Leakage at Nominal Voltage - 60 Hz	2.5 mA @ 240 VAC 1.25 mA @ 120 VAC	2.5 mA @ 240 VAC 1.25 mA @ 120 VAC	2.5 mA @ 240 VAC 1.25 mA @ 120 VAC
Peak Blocking Voltage	500 V	500 V	500 V
Operating Frequency	25–65 Hz	25–65 Hz	25–65 Hz
dV/ dt - Off-state	200 volts/msec	200 volts/msec	200 volts/msec
dV/ dt - Commutating	Snubbed for rated 0.5 power factor load	Snubbed for rated 0.5 power factor load	Snubbed for rated 0.5 power factor load
Fuse (Common to all Channels)	250 VAC - 4A 5x20 mm Fast-acting Bell Fuse Part: BEL 5HF4 Opto 22 Part: SNAP-FUSE4AB	Has four isolated channels. User must provide own fusing.	Has four isolated channels. User must provide own fusing.
Channel-to-channel isolation	Not applicable	300 VAC (1500 V transient)	300 VAC (1500 V transient)
Logic Side Ratings			
Pickup Voltage	4 V @ 5.5 mA	4 V @ 5.5 mA	4 V @ 5.5 mA
Dropout Voltage	1 VDC	1 VDC	1 VDC
Control Resistance	220 ohms	220 ohms	220 ohms
Logic Supply Voltage	5 VDC ± 0.25 VDC	5 VDC ± 0.25 VDC	5 VDC ± 0.25 VDC
Logic Supply Current	50 mA maximum	50 mA maximum	50 mA maximum
Module Ratings			
Number of Channels Per Module	4	4	4
Turn-on Time	0.5 cycle maximum (zero volts crossover)	0.5 cycle maximum (zero volts crossover)	0.5 cycle maximum (zero volts crossover)
Turn-off Time	0.5 cycle maximum (zero current crossover)	0.5 cycle maximum (zero current crossover)	0.5 cycle maximum (zero current crossover)
Isolation (Field Side to Logic Side)	4,000 volts (transient)	4,000 volts (transient)	4,000 volts (transient)
Temperature	-20 ° to 70 °C, operating -40 ° to 85 °C, storage	-20 ° to 70 °C, operating -40 ° to 85 °C, storage	-20 ° to 70 °C, operating -40 ° to 85 °C, storage
Wire size range	22 to 14 AWG	22 to 14 AWG	22 to 14 AWG
Agency Approvals	UL, CE, CSA, RoHS, DFARS; UKCA	UL, CE, RoHS, DFARS; UKCA	UL, CE, RoHS, DFARS; UKCA
Warranty	Lifetime	30 months	Lifetime

SPECIFICATIONS—AC MODULES (CONTINUED)

	SNAP-OAC5-FM	SNAP-OAC5-I-FM
Key Feature	Factory Mutual approved	Four isolated channels Factory Mutual approved
Torque, hold-down screws	4 in-lb (0.45 N-m)	4 in-lb (0.45 N-m)
Torque, connector screws	5.26 in-lb (0.6 N-m)	5.26 in-lb (0.6 N-m)
Field Side Ratings (each channel)		
Line Voltage - Range	12–250 VAC	12–250 VAC
Line Voltage - Nominal	120/240 VAC	120/240 VAC
Current Rating 0 °C to 70 °C Ambient	3 amps per module	3 amps per module
One Cycle Surge	80 amps peak (50/60 Hz)	80 amps peak (50/60 Hz)
Minimum Load Current	20 mA	20 mA
Output Voltage Drop	1.6 volts max. @ 0.75 amps	1.6 volts max. @ 0.75 amps
Off-state Leakage at Nominal Voltage - 60 Hz	2.5 mA @ 240 VAC 1.25 mA @ 120 VAC	2.5 mA @ 240 VAC 1.25 mA @ 120 VAC
Peak Blocking Voltage	500 V	500 V
Operating Frequency	25–65 Hz	25–65 Hz
dV/ dt - Off-state	200 volts/msec	200 volts/msec
dV/ dt - Commutating	Snubbed for rated 0.5 power factor load	Snubbed for rated 0.5 power factor load
Fuse (Common to all Channels)	250 VAC - 4A 5x20 mm Fast-acting Bell Fuse Part No. BEL 5HF4 Opto 22 Part No. SNAP-FUSE4AB	Has four isolated channels. User must provide own fusing.
Channel-to-channel isolation	Not applicable	300 VAC (1500 V transient)
Logic Side Ratings		
Pickup Voltage	4 V @ 5.5 mA	4 V @ 5.5 mA
Dropout Voltage	1 VDC	1 VDC
Control Resistance	220 ohms	220 ohms
Logic Supply Voltage	5 VDC ± 0.25 VDC	5 VDC ± 0.25 VDC
Logic Supply Current	50 mA maximum	50 mA maximum
Module Ratings		
Channels Per Module	4	4
Turn-on Time	0.5 cycle maximum (zero volts crossover)	0.5 cycle maximum (zero volts crossover)
Turn-off Time	0.5 cycle maximum (zero current crossover)	0.5 cycle maximum (zero current crossover)
Isolation (Field Side to Logic Side)	4,000 volts (transient)	4,000 volts (transient)
Temperature	-20 ° to 70 °C, operating -40 ° to 85 °C, storage	-20 ° to 70 °C, operating -40 ° to 85 °C, storage
Wire size range	22 to 14 AWG	22 to 14 AWG
Agency Approvals	CE, FM, RoHS, DFARS; UKCA	CE, FM, RoHS, DFARS; UKCA
Warranty	Lifetime	Lifetime

SCHEMATICS

SNAP-OAC5 Output Module

Part Number	Description
SNAP-OAC5	4-channel AC output 12–250 VAC 5 VDC logic
SNAP-OAC5FM	4-channel AC output 12–250 VAC 5 VDC logic, Factory Mutual approved

Note: In hazardous locations, SNAP-OAC5FM modules must be mounted in an enclosure that meets the requirements of the National Electrical Code, ANSI/NFPA 70 and ANSI/ISA-61010-1 (82.02.01).

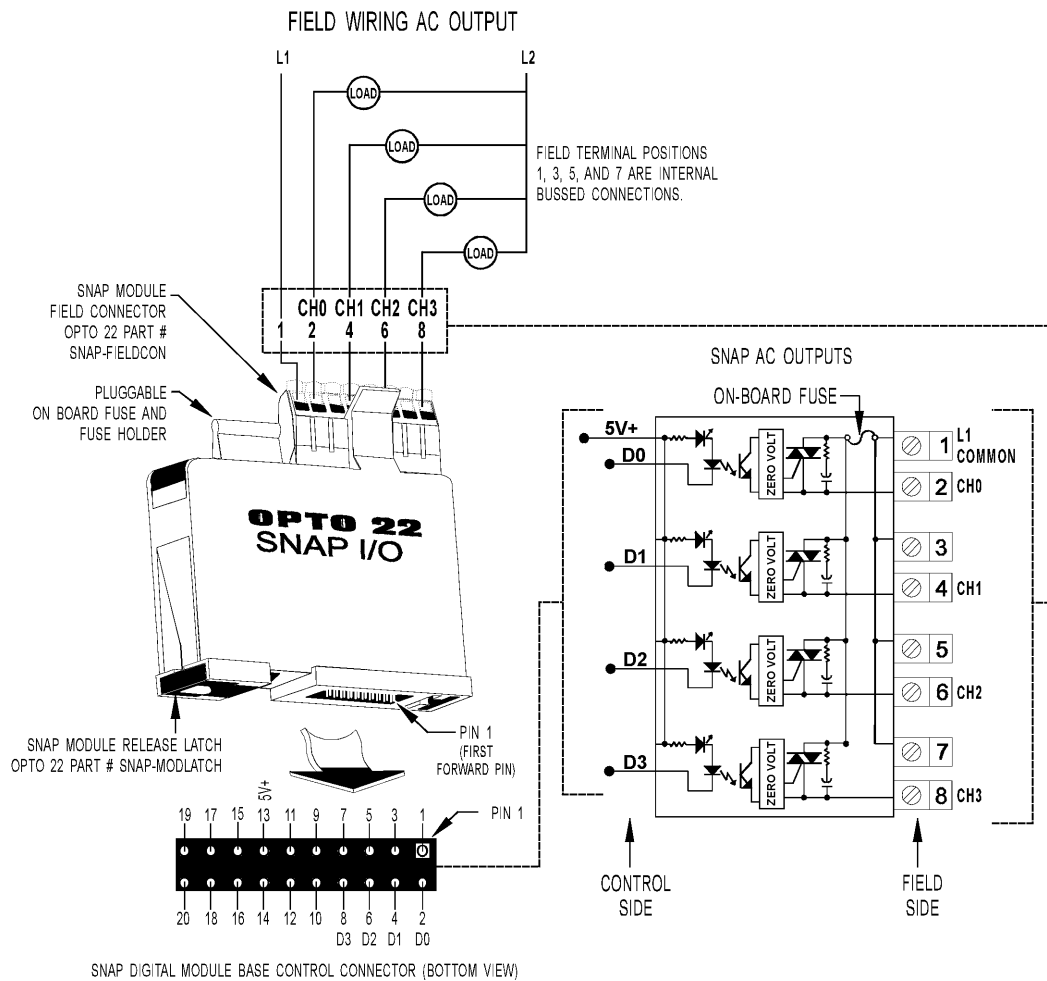

SCHEMATICS

SNAP-OAC5MA Output Module With Manual/Auto Switches

Part Number	Description
SNAP-OAC5MA	4-channel isolated AC output 12–250 VAC, 5 VDC logic, with manual/auto switch

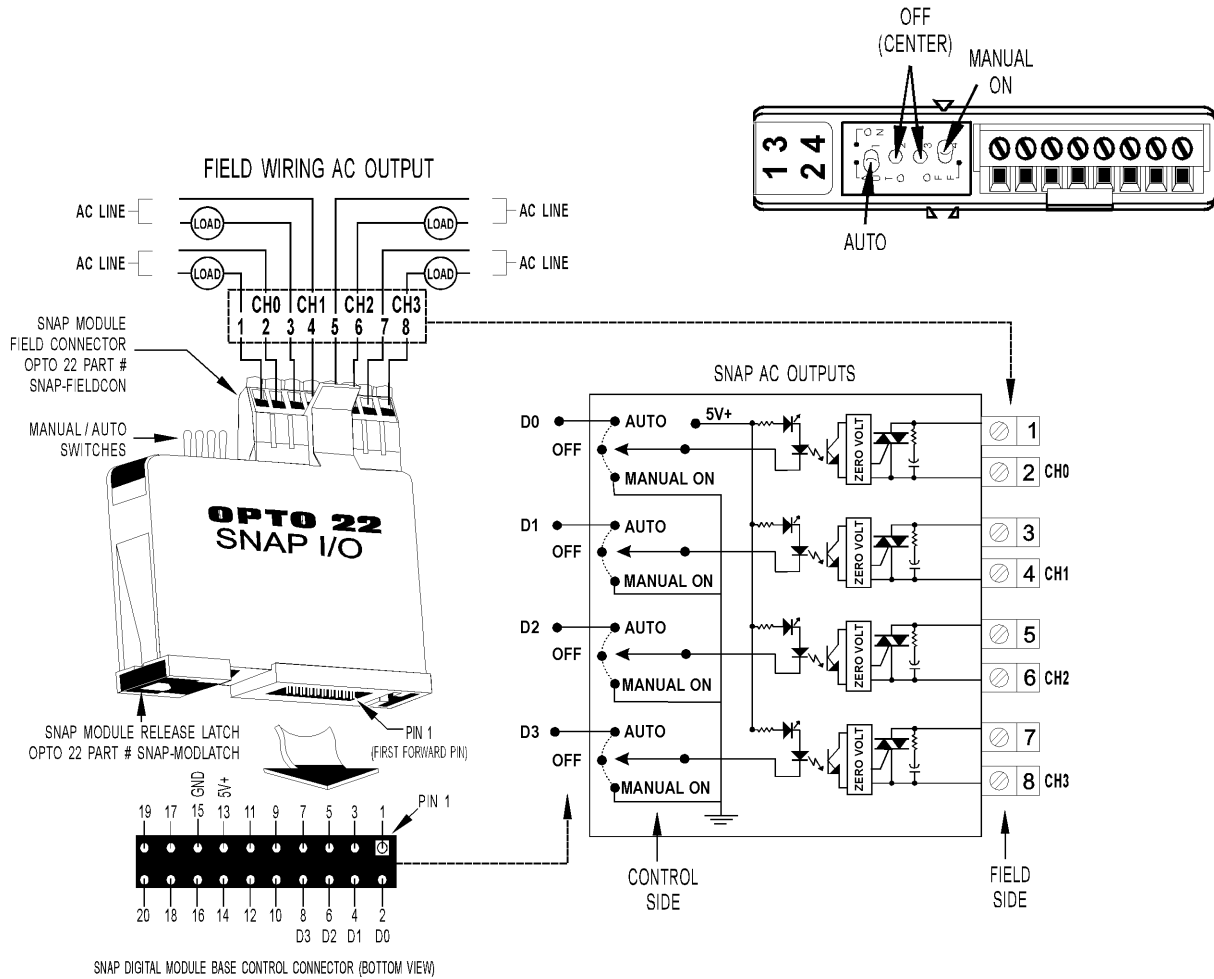

SCHEMATICS

SNAP-OAC5i Isolated Output Module

Part Number	Description
SNAP-OAC5-i	4-channel isolated AC output 12–250 VAC, 5 VDC logic
SNAP-OAC5-iFM	4-channel isolated AC output 12–250 VAC, 5 VDC logic, Factory Mutual approved

Note: In hazardous locations, SNAP-OAC5-iFM modules must be mounted in an enclosure that meets the requirements of the National Electrical Code, ANSI/NFPA 70 and ANSI/ISA-61010-1 (82.02.01).

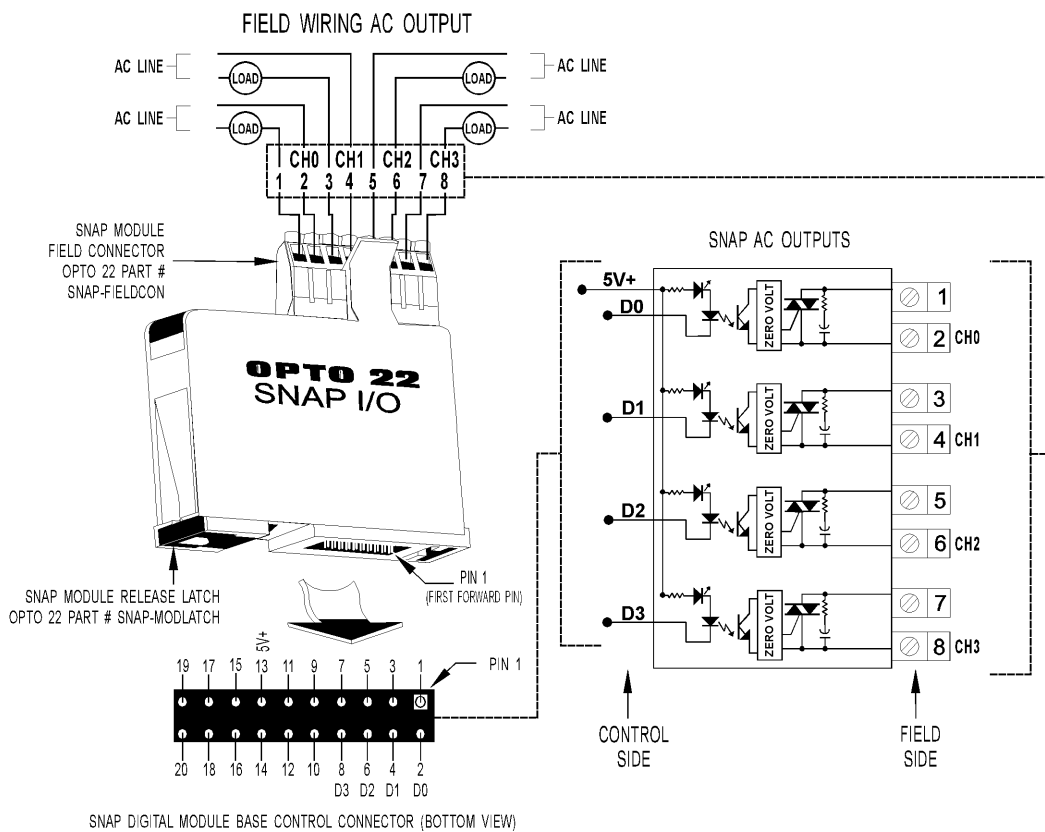

SPECIFICATIONS—DC MODULES

	SNAP-ODC5SRC	SNAP-ODC5SNK
Key Feature	Load sourcing	Load sinking
Torque, hold-down screws	4 in-lb (0.45 N-m)	4 in-lb (0.45 N-m)
Torque, connector screws	5.26 in-lb (0.6 N-m)	5.26 in-lb (0.6 N-m)
Field Side Ratings (each channel)		
Line Voltage - Range	5–60 VDC	5–60 VDC
Line Voltage - Nominal	5–48 VDC	5–48 VDC
Current Rating 0 °C to 70 °C Ambient	3 amps per module	3 amps per module
Surge Current	5 amps peak for 1 second	5 amps peak for 1 second
Minimum Load	20 mA	20 mA
Output Voltage Drop	1.6 volts max. @ 0.75 amps	1.6 volts max. @ 0.75 amps
Off-state Leakage	1 mA @ 60 VDC	1 mA @ 60 VDC
Peak Blocking Voltage	60 VDC	60 VDC
Fuse (Common to all Channels)	250 VAC - 4A 5x20 mm Fast-acting Bell Fuse Part No. BEL 5HF4 Opto 22 Part SNAP-FUSE4AB	250 VAC - 4A 5x20 mm Fast-acting Bell Fuse Part No. BEL 5HF4 Opto 22 Part SNAP-FUSE4AB
Channel-to-channel isolation	Not applicable	Not applicable
Logic Side Ratings		
Pickup Voltage	4 V @ 5.5 mA	4 V @ 5.5 mA
Dropout Voltage	1 VDC	1 VDC
Control Resistance	220 ohms	220 ohms
Logic Supply Voltage	5 VDC ± 0.25 VDC	5 VDC ± 0.25 VDC
Logic Supply Current	50 mA maximum	50 mA maximum
Module Ratings		
Number of Channels Per Module	4	4
Turn-on Time	100 usec	100 usec
Turn-off Time	750 usec	750 usec
Isolation (Field Side to Logic Side)	4,000 volts (transient)	4,000 volts (transient)
Temperature	-20 to 70 °C, operating -40 to 85 °C, storage	-20 to 70 °C, operating -40 to 85 °C, storage
Wire size range	22 to 14 AWG	22 to 14 AWG
Agency Approvals	UL, CE, CSA, RoHS, DFARS; UKCA	UL, CE, CSA, RoHS, DFARS; UKCA
Warranty	Lifetime	Lifetime

SPECIFICATIONS—DC MODULES (CONTINUED)

	SNAP-ODC5MA	SNAP-ODC5-i	SNAP-ODC5A-i	SNAP-ODC5ASNK
Key Feature	Diagnostic switches Four isolated channels	Four isolated channels	Four isolated channels	Load sinking
Torque, hold-down screws	4 in-lb (0.45 N-m)	4 in-lb (0.45 N-m)	4 in-lb (0.45 N-m)	4 in-lb (0.45 N-m)
Torque, connector screws	5.26 in-lb (0.6 N-m)	5.26 in-lb (0.6 N-m)	5.26 in-lb (0.6 N-m)	5.26 in-lb (0.6 N-m)
Field Side Ratings (each channel)				
Line Voltage - Range	5–60 VDC	5–60 VDC	5–200 VDC	5–200 VDC
Line Voltage - Nominal	5–48 VDC	5–48 VDC	5–200 VDC	5–200 VDC
Current Rating 0 °C to 70 °C Ambient	2 amps per module 0.5 amps per channel	3 amps per module	3 amps per module	3 amps per module
Surge Current	1.5 amps peak for 1 second	5 amps peak for 1 second	5 amps peak for 1 second	5 amps peak for 1 second
Minimum Load	20 mA	20 mA	20 mA	20 mA
Output Voltage Drop	1.6 volts max. @ 0.75 amps	1.6 volts max. @ 0.75 amps	1.6 volts max. @ 0.75 amps	1.6 volts max. @ 0.75 amps
Off-state Leakage	1 mA @ 60 VDC	1 mA @ 60 VDC	1 mA @ 200 VDC	1 mA @ 200 VDC
Peak Blocking Voltage	60 VDC	60 VDC	200 VDC	200 VDC
Fuse (Common to all Channels)	Has four isolated channels. User must provide own fusing.	Has four isolated channels. User must provide own fusing.	Has four isolated channels. User must provide own fusing.	250 VAC - 4A 5x20 mm Fast-acting Bell Fuse Part: BEL 5HF4 Opto 22 Part: SNAP- FUSE4AB
Channel-to-channel isolation	300 VAC (1500 V transient)	300 VAC (1500 V transient)	300 VAC (1500 V transient)	Not applicable
Logic Side Ratings				
Pickup Voltage	4 V @ 5.5 mA	4 V @ 5.5 mA	4 V @ 5.5 mA	4 V @ 5.5 mA
Dropout Voltage	1 VDC	1 VDC	1 VDC	1 VDC
Control Resistance	220 ohms	220 ohms	220 ohms	220 ohms
Logic Supply Voltage	5 VDC ± 0.25 VDC	5 VDC ± 0.25 VDC	5 VDC ± 0.25 VDC	5 VDC ± 0.25 VDC
Logic Supply Current	50 mA maximum	50 mA maximum	50 mA maximum	50 mA maximum
Module Ratings				
Number of Channels Per Module	4	4	4	4
Turn-on Time	100 usec	100 usec	100 usec	100 usec
Turn-off Time	750 usec	750 usec	750 usec	750 usec
Isolation (Field Side to Logic Side)	4,000 volts (transient)	4,000 volts (transient)	4,000 volts (transient)	4,000 volts (transient)
Temperature	-20 to 70 °C, operating -40 to 85 °C, storage	-20 to 70 °C, operating -40 to 85 °C, storage	-20 to 70 °C, operating -40 to 85 °C, storage	-20 to 70 °C, operating -40 to 85 °C, storage
Wire size range	22 to 14 AWG	22 to 14 AWG	22 to 14 AWG	22 to 14 AWG
Agency Approvals	UL, CE, RoHS, DFARS; UKCA	UL, CE, RoHS, DFARS; UKCA	UL, CE, RoHS, DFARS; UKCA	UL, CE, RoHS, DFARS; UKCA
Warranty	30 months	Lifetime	Lifetime	Lifetime

SPECIFICATIONS—DC MODULES (CONTINUED)

	SNAP-ODC5SRCFM	SNAP-ODC5SNKFM
Key Feature	Factory Mutual approved	Factory Mutual approved
Torque, hold-down screws	4 in-lb (0.45 N-m)	4 in-lb (0.45 N-m)
Torque, connector screws	5.26 in-lb (0.6 N-m)	5.26 in-lb (0.6 N-m)
Field Side Ratings (each channel)		
Line Voltage - Range	5–60 VDC	5–60 VDC
Line Voltage - Nominal	5–48 VDC	5–48 VDC
Current Rating 0°C to 70°C Ambient	3 amps per module	3 amps per module
Surge Current	5 amps peak for 1 second	5 amps peak for 1 second
Minimum Load	20 mA	20 mA
Output Voltage Drop	1.6 volts max.@ 0.75 amps	1.6 volts max.@ 0.75 amps
Off-state Leakage	1 mA @ 60 VDC	1 mA @ 60 VDC
Peak Blocking Voltage	60 VDC	60 VDC
Fuse (Common to all Channels)	250 VAC - 4A 5x20 mm Fast-acting Bell Fuse Part No. BEL 5HF4 Opto 22 Part SNAP-FUSE4AB	250 VAC - 4A 5x20 mm Fast-acting Bell Fuse Part No. BEL 5HF4 Opto 22 Part SNAP-FUSE4AB
Logic Side Ratings		
Pickup Voltage	4 V @ 5.5 mA	4 V @ 5.5 mA
Dropout Voltage	1 VDC	1 VDC
Control Resistance	220 ohms	220 ohms
Logic Supply Voltage	5 VDC ± 0.25 VDC	5 VDC ± 0.25 VDC
Logic Supply Current	50 mA maximum	50 mA maximum
Module Ratings		
Number of Channels Per Module	4	4
Turn-on Time	100 usec	100 usec
Turn-off Time	750 usec	750 usec
Isolation (Field Side to Logic Side)	4,000 volts (transient)	4,000 volts (transient)
Temperature	-20 to 70 °C, operating -40 to 85 °C, storage	-20 to 70 °C, operating -40 to 85 °C, storage
Wire size range	22 to 14 AWG	22 to 14 AWG
Agency Approvals	CE, FM, RoHS, DFARS; UKCA	CE, FM, RoHS, DFARS; UKCA
Warranty	Lifetime	Lifetime

SPECIFICATIONS—DC MODULES (CONTINUED)

	SNAP-ODC5-IFM	SNAP-ODC5A-IFM
Key Feature	Four isolated channels Factory Mutual approved	Four isolated channels Factory Mutual approved
Torque, hold-down screws	4 in-lb (0.45 N-m)	4 in-lb (0.45 N-m)
Torque, connector screws	5.26 in-lb (0.6 N-m)	5.26 in-lb (0.6 N-m)
Field Side Ratings (each channel)		
Line Voltage - Range	5–60 VDC	5–200 VDC
Line Voltage - Nominal	5–48 VDC	5–200 VDC
Current Rating 0°C to 70°C Ambient	3 amps per module	3 amps per module
Surge Current	5 amps peak for 1 second	5 amps peak for 1 second
Minimum Load	20 mA	20 mA
Output Voltage Drop	1.6 volts max.@ 0.75 amps	1.6 volts max.@ 0.75 amps
Off-state Leakage	1 mA @ 60 VDC	1 mA @ 60 VDC
Peak Blocking Voltage	60 VDC	200 VDC
Fuse (Common to all Channels)	Has four isolated channels. User must provide own fusing.	Has four isolated channels. User must provide own fusing.
Logic Side Ratings		
Pickup Voltage	4 V @ 5.5 mA	4 V @ 5.5 mA
Dropout Voltage	1 VDC	1 VDC
Control Resistance	220 ohms	220 ohms
Logic Supply Voltage	5 VDC ± 0.25 VDC	5 VDC ± 0.25 VDC
Logic Supply Current	50 mA maximum	50 mA maximum
Module Ratings		
Number of Channels Per Module	4	4
Turn-on Time	100 usec	100 usec
Turn-off Time	750 usec	750 usec
Isolation (Field Side to Logic Side)	4,000 volts (transient)	4,000 volts (transient)
Temperature	-20 ° to 70 °C, operating -40 ° to 85 °C, storage	-20 ° to 70 °C, operating -40 ° to 85 °C, storage
Wire size range	22 to 14 AWG	22 to 14 AWG
Agency Approvals	CE, FM, ATEX, RoHS, DFARS; UKCA	CE, FM, RoHS, DFARS; UKCA
Warranty	Lifetime	Lifetime

SCHEMATICS

SNAP-ODC5SRC Output Module— Sourcing

Part Number	Description
SNAP-ODC5SRC	4-channel DC output 5–60 VDC logic source
SNAP-ODC5SRCFM	4-channel DC output 5–60 VDC logic source, Factory Mutual approved

Note: In hazardous locations, SNAP-ODCSRCFM modules must be mounted in an enclosure that meets the requirements of the National Electrical Code, ANSI/NFPA 70 and ANSI/ISA-61010-1 (82.02.01).

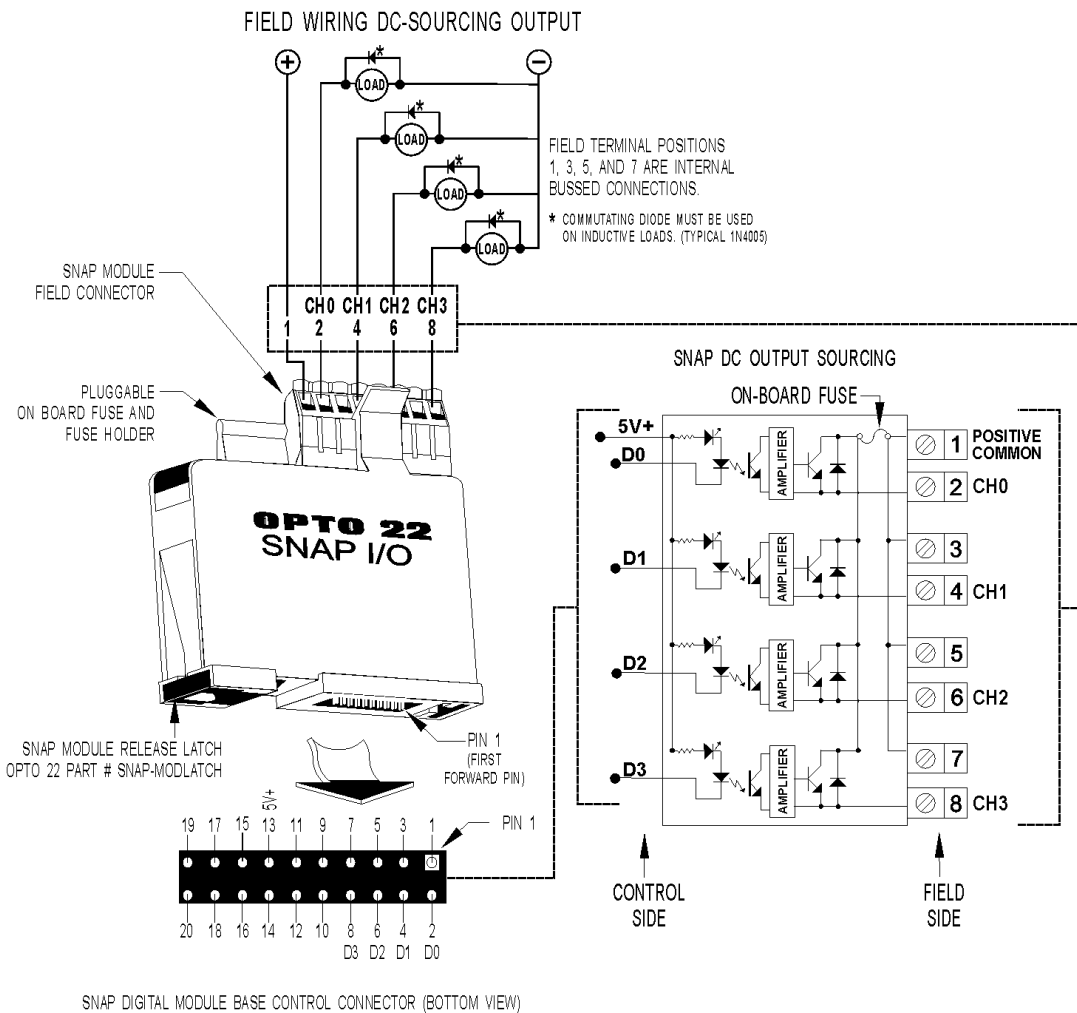

SCHEMATICS

SNAP-ODC5SNK and SNAP-ODC5ASNK Output Modules—Sinking

Part Number	Description
SNAP-ODC5SNK	4-channel DC output 5–60 VDC logic sink
SNAP-ODC5SNKFM	4-channel DC output 5–60 VDC logic sink, Factory Mutual approved
SNAP-ODC5ASNK	4-channel DC output 5–200 VDC logic sink

Note: In hazardous locations, SNAP-ODC5SNKFM modules must be mounted in an enclosure that meets the requirements of the National Electrical Code, ANSI/NFPA 70 and ANSI/ISA-61010-1 (82.02.01).

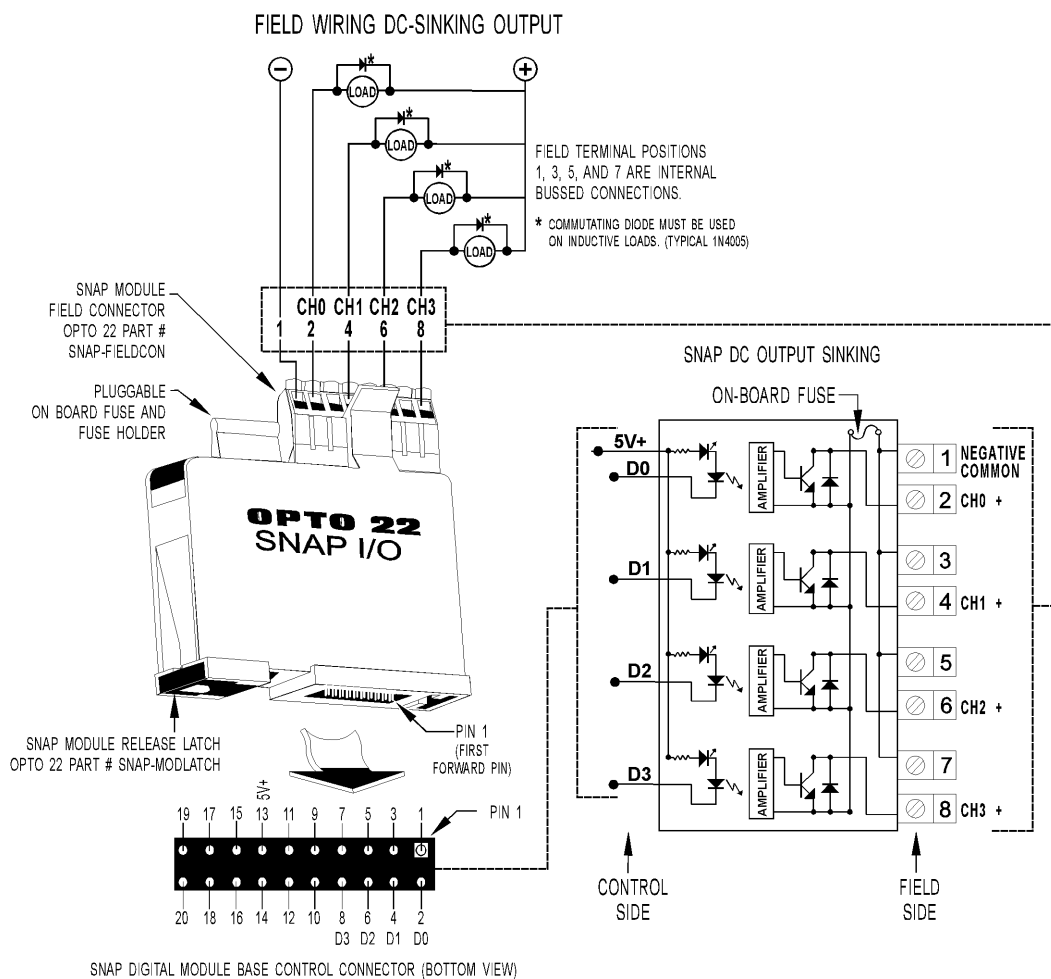

SCHEMATICS

SNAP-ODC5MA Output Module with Manual/Auto Switches

Part Number	Description
SNAP-ODC5MA	4-channel isolated DC output 5–60 VDC, 5 VDC logic, with manual/auto switches

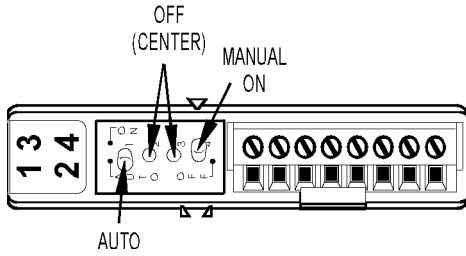

TYPICAL WIRING EXAMPLES

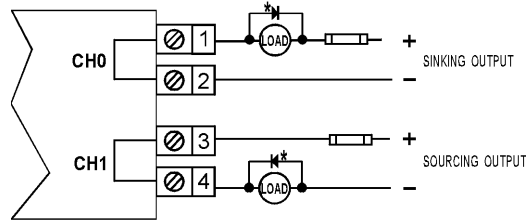

FIELD WIRING DC OUTPUT

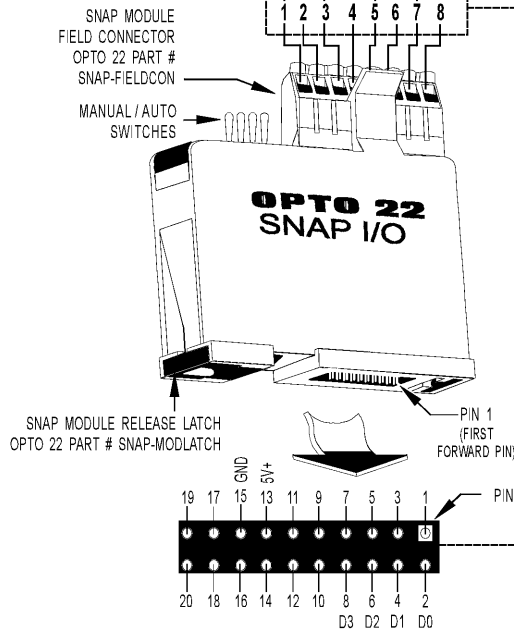
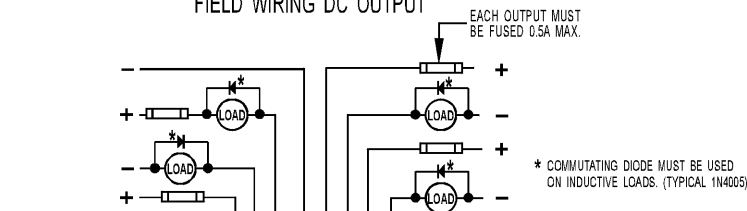

SNAP DIGITAL MODULE BASE CONTROL CONNECTOR (BOTTOM VIEW)

SCHEMATICS

SNAP-ODC5-i and SNAP-ODC5A-i Isolated Output Module

Part Number	Description
SNAP-ODC5-i	4-channel isolated DC output 5–60 VDC, 5 VDC logic
SNAP-ODC5A-i	4-channel isolated DC output 5–200 VDC, 5 VDC logic
SNAP-ODC5-iFM	4-channel isolated DC output 5–60 VDC, 5 VDC logic, Factory Mutual approved
SNAP-ODC5A-iFM	4-channel isolated DC output 5–200 VDC, 5 VDC logic, Factory Mutual approved

Note: In hazardous locations, SNAP-ODC5-iFM and SNAP-ODC5A-iFM modules must be mounted in an enclosure that meets the requirements of the National Electrical Code, ANSI/NFPA 70 and ANSI/ISA-61010-1 (82.02.01).

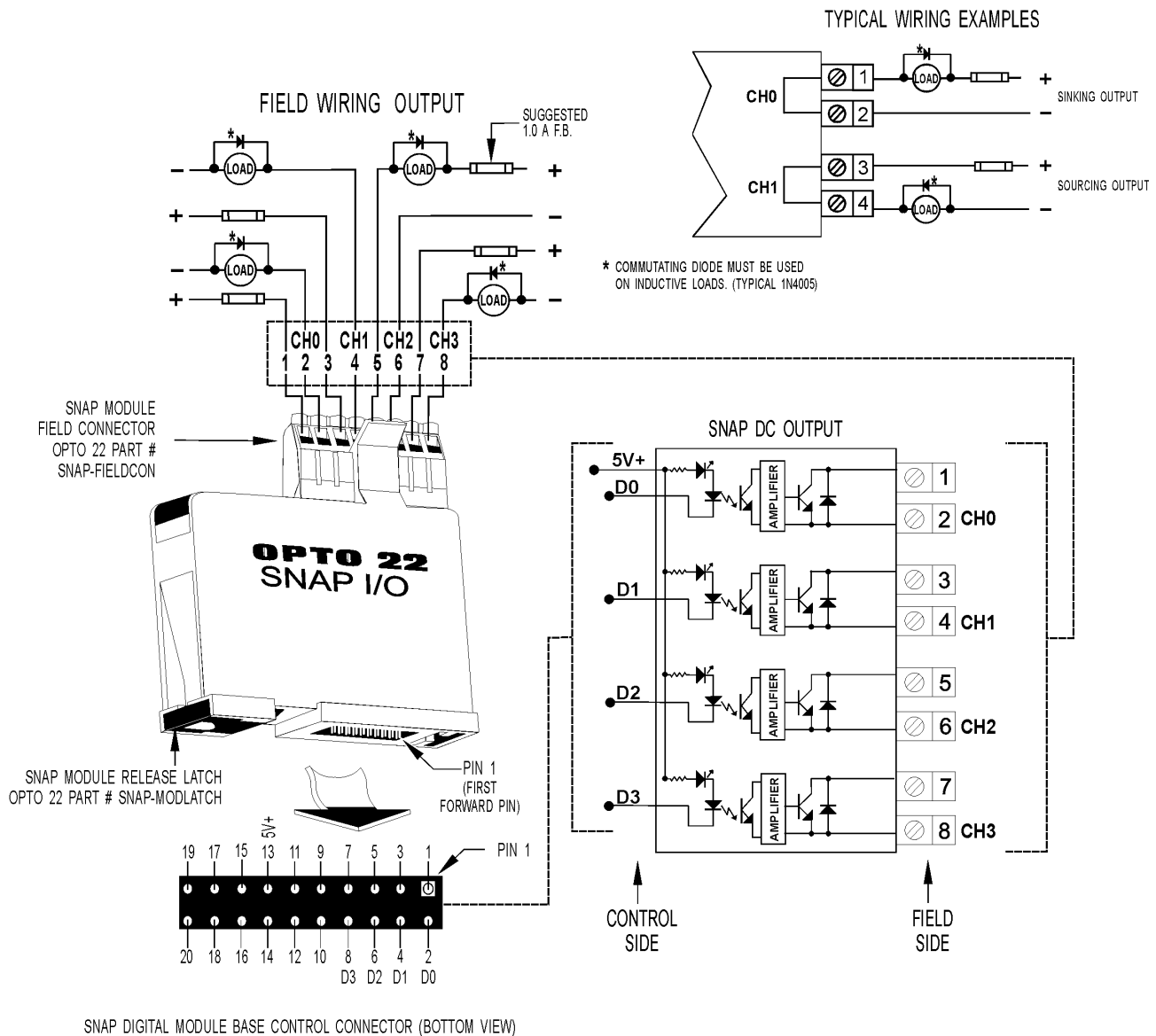

DIMENSIONAL DRAWING

All Models Except MA

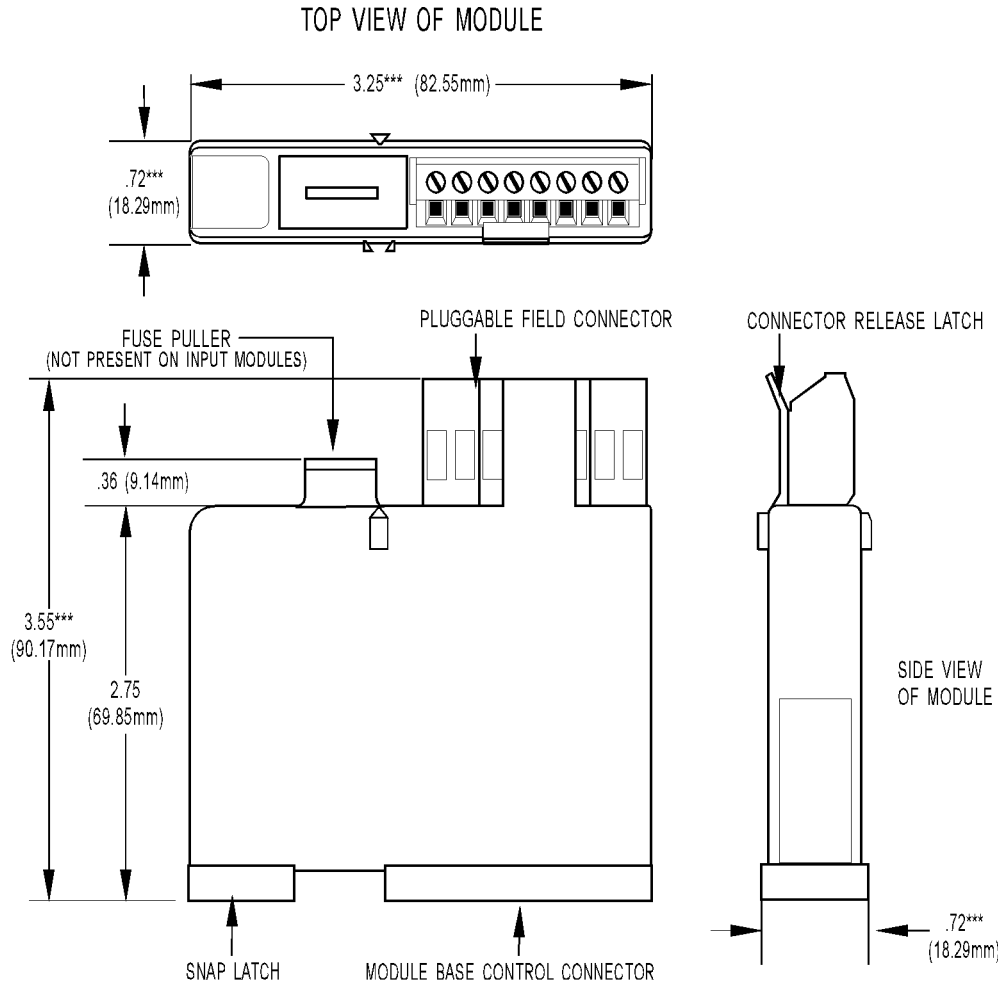

TOLERANCES LEGEND

* +/- .010" ** +/- .020"
 *** +/- .030" **** +/- .060"
 NO * REFERENCE ONLY

DIMENSIONAL DRAWING

All MA Models

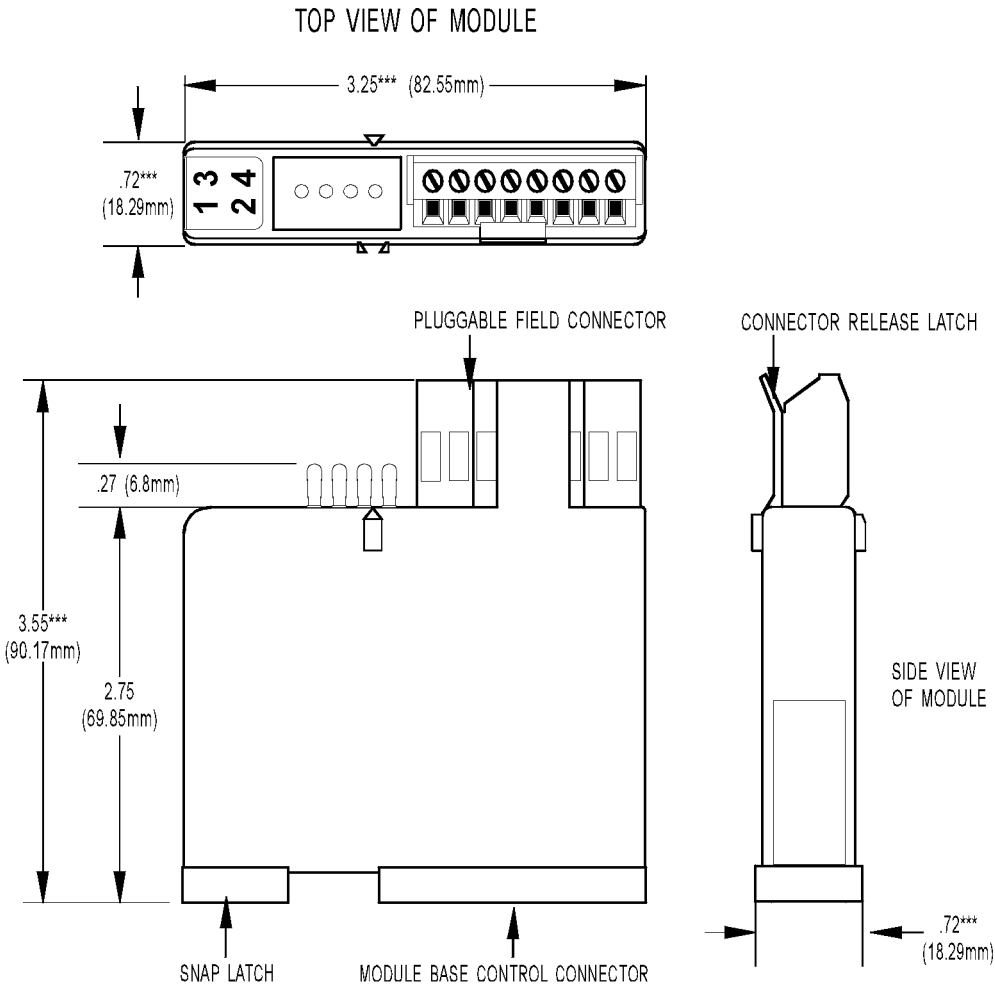

TOLERANCES LEGEND

* +/- .010" ** +/- .020"
 *** +/- .030" **** +/- .060"
 NO * REFERENCE ONLY

DIMENSIONAL DRAWING

All Models

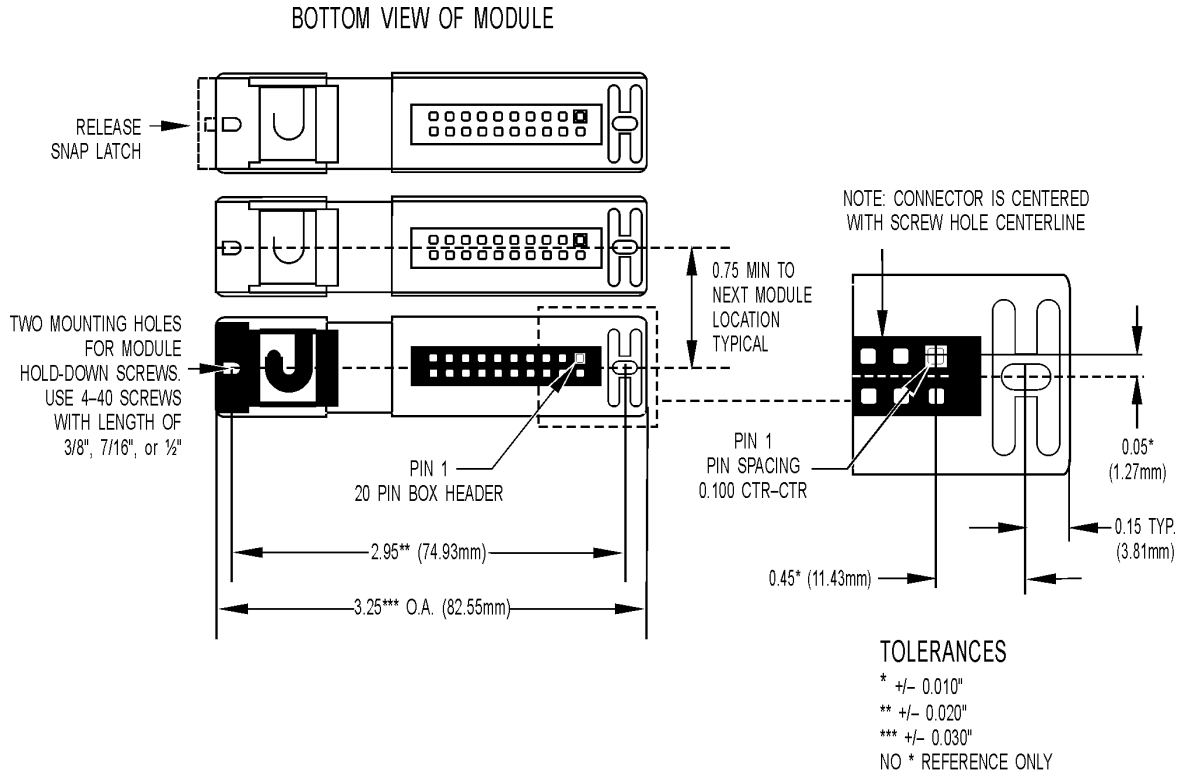

IMPORTANT: The mounting rack connector has 24 pins; the module connector has 20 pins. The extra pins on the mounting rack connector prevent misalignment of the module during installation.

DIMENSIONAL DRAWING

All Models

SNAP Digital Module Mounted on SNAP Rack

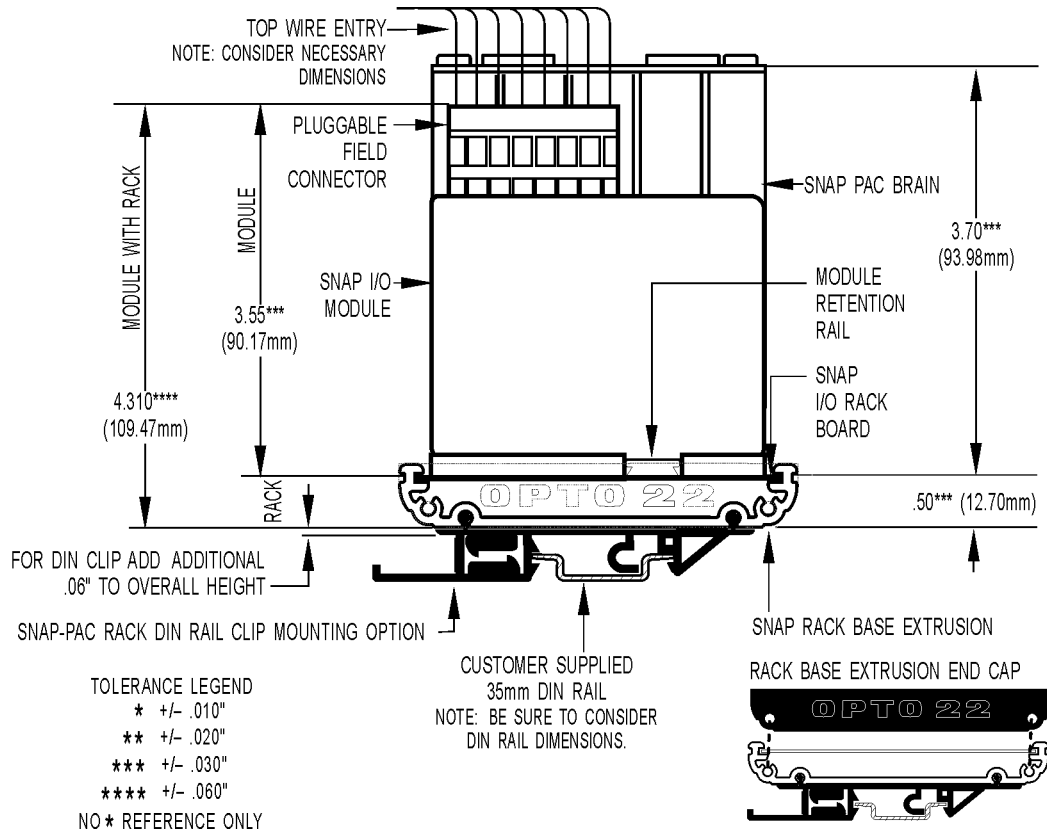

PRODUCTS

Opto 22 develops and manufactures reliable, easy-to-use, open standards-based hardware and software products. Industrial automation, process control, remote monitoring, data acquisition, and industrial internet of things (IIoT) applications worldwide all rely on Opto 22.

groov RIO®

groov RIO edge I/O offers a single, compact, PoE-powered industrial package with web-based configuration and IIoT software built in, support for multiple OT and IT protocols, and security features like a device firewall, data encryption, and user account control.

Standing alone, groov RIO connects to sensors, equipment, and legacy systems, collecting and securely publishing data from field to cloud. Choose a universal I/O model with thousands of possible field I/O configurations, with or without Ignition from Inductive Automation®, or a RIO EMU energy monitoring unit that reports 64 energy data values from 3-phase loads up to 600 VAC, Delta or Wye.

You can also use groov RIO with a Modbus/TCP master or as remote I/O for a groov EPIC system.

groov EPIC® System

Opto 22's groov Edge Programmable Industrial Controller (EPIC) system gives you industrially hardened control with a flexible Linux®-based processor with gateway functions, guaranteed-for-life I/O, and software for your automation and IIoT applications.

groov EPIC Processor

The heart of the system is the groov EPIC processor. It handles a wide range of digital, analog, and serial functions for data collection, remote monitoring, process control, and discrete and hybrid manufacturing.

In addition, the EPIC provides secure data communications among physical assets, control systems, software applications, and online services, both on premises and in the cloud. No industrial PC needed.

Configuring and troubleshooting I/O and networking is easier with the EPIC's integrated high-resolution color touchscreen. Authorized users can manage the system locally on the touchscreen, on a monitor connected via the HDMI or USB ports, or on a PC or mobile device with a web browser.

groov EPIC I/O

groov I/O connects locally to sensors and equipment. Modules have a spring-clamp terminal strip, integrated wireway, swing-away cover, and LEDs indicating module health and discrete channel status. groov I/O is hot swappable, UL Hazardous Locations approved, and ATEX compliant.

groov EPIC Software

The groov EPIC processor comes ready to run the software you need:

- Programming: Choose flowchart-based PAC Control, CODESYS Development System for IEC61131-3 compliant programs, or secure shell access (SSH) to the Linux OS for custom applications
- Node-RED for creating simple IIoT logic flows from pre-built nodes
- Efficient MQTT data communications with string or Sparkplug data formats
- HMI: groov View to build your own HMI viewable on touchscreen, PCs, and mobile devices; PAC Display for a Windows HMI; Node-RED dashboard UI
- Ignition or Ignition Edge® from Inductive Automation (requires license purchase) with OPC-UA drivers to Allen-Bradley®, Siemens®, and other control systems, and MQTT communications



Older products

From solid state relays, to world-famous G4 and SNAP I/O, to SNAP PAC controllers, older Opto 22 products are still supported and working hard at thousands of installations worldwide. You can count on us for the reliability and service you expect, now and in the future.

QUALITY

Founded in 1974, Opto 22 has established a worldwide reputation for high-quality products. All are made in the U.S.A. at our manufacturing facility in Temecula, California.

Because we test each product twice before it leaves our factory rather than testing a sample of each batch, we can afford to guarantee most solid-state relays and optically isolated I/O modules for life.

FREE PRODUCT SUPPORT

Opto 22's California-based Product Support Group offers free technical support for Opto 22 products from engineers with decades of training and experience. Support is available in English and Spanish by phone or email, Monday–Friday, 7 a.m. to 5 p.m. PST.

Support is always available on our website, including [free online training](#) at OptoU, how-to [videos](#), [user's guides](#), the Opto 22 KnowledgeBase, and [OptoForums](#).

PURCHASING OPTO 22 PRODUCTS

Opto 22 products are sold directly and through a worldwide network of distributors, partners, and system integrators. For more information, contact Opto 22 headquarters at **800-321-6786** (toll-free in the U.S. and Canada) or **+1-951-695-3000**, or visit our website at www.opto22.com.