

High Power LED Series Chip Scale Package

LH181B

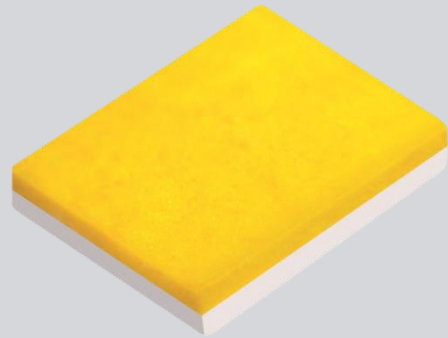

Use of Samsung's Chip Scale Package technology
provide high performance and energy conserving



Features & Benefits

- Utilizes Samsung TF chip technology
- Suitable for use in indoor and outdoor lighting
- Operates at a maximum current of up to 1.4 A
- Compact footprint (2.36 x 2.36 mm)

Applications

- Indoor Lighting: Spotlight, Downlight, MR, PAR
- Outdoor Lighting: Street Light, Tunnel Light, Security Light, Parking Lot Light
- Industrial Lighting: High Bay Light, Low Bay Light
- Consumer Lighting: Torch Light

Table of Contents

1.	Characteristics	-----	3
2.	Product Code Information	-----	6
3.	Typical Characteristics Graphs	-----	11
4.	Outline Drawing & Dimension	-----	13
5.	Reliability Test Items & Conditions	-----	14
6.	Soldering Conditions	-----	15
7.	Tape & Reel	-----	16
8.	Label Structure	-----	18
9.	Packing Structure	-----	19
10.	Precautions in Handling & Use	-----	21

1. Characteristics

a) Absolute Maximum Rating

Item	Symbol	Rating	Unit	Condition
Ambient / Operating Temperature	T_a	-40 ~ +100	°C	Note 1)
Storage Temperature	T_{stg}	-40 ~ +125	°C	-
LED Junction Temperature	T_j	135	°C	-
Forward Current	I_F	1400	mA	Note 1)
Peak Pulse Forward Current	I_{FP}	2000	mA	Duty 1/10 pulse width 10ms
Assembly Process Temperature	-	260 <10	°C s	-
ESD (HBM)	-	±2	kV	-

Note:

- 1) Refer to the derating curve, '3. Typical Characteristics Graph', for proper driving current that maintained below maximum junction temperature.

b) Electro-optical Characteristics

Item	Unit	Nominal CCT (K)	Condition		Value Typ.
			I _F (mA)	T _J (°C)	
Luminous Flux (Φ _v)	lm	3500 (80 CRI)	350	25	168
			350	85	152
			700	85	283
			1000	85	381
			1400	85	492
Forward Voltage (V _F)	V		350	25	2.92
			350	85	2.82
			700	85	2.97
			1000	85	3.08
			1400	85	3.20
Thermal Resistance (junction to solder point)	K/W				2
Beam Angle	°				120

Note:

Samsung maintains measurement tolerance of: luminous flux = ±7%, forward voltage = ±0.1 V

c) Luminous Flux Characteristics (T_s = 85 °C)

Sorting @ 350 mA (lm)			Calculated Minimum Flux ²⁾ (lm)			
Flux Rank	Flux Range ¹⁾	Sub Rank	@ 350 mA	@ 700 mA	@ 1050 mA	@ 1500 mA
E3	80 ~ 110	E1, F1, G1	80	149	200	259
F3	90 ~ 120	F1, G1, H1	90	167	226	291
G3	100 ~ 130	G1, H1, J1	100	186	251	324
H3	110 ~ 140	H1, J1, K1	110	205	276	356
J3	120 ~ 150	J1, K1, M1	120	223	301	388
K3	130 ~ 160	K1, M1, N1	130	242	326	421
M3	140 ~ 170	M1, N1, P1	140	260	351	453
N3	150 ~ 180	N1, P1, Q1	150	279	376	485
P3	160 ~ 190	P1, Q1, R1	160	298	401	518
Q3	170 ~ 200	Q1, R1, S1	170	316	426	550
R3	180 ~ 210	R1, S1, T1	180	335	451	582
S3	190 ~ 220	S1, T1, U1	190	353	476	615
T3	200 ~ 230	T1, U1, V1	200	372	501	647
U3	210 ~ 240	U1, V1, W1	210	391	526	679
V3	220 ~ 250	V1, W1, X1	220	409	551	712
W3	230 ~ 260	W1, X1, Y1	230	428	576	744
X3	240 ~ 270	X1, Y1, Z1	240	446	601	776
Y3	250 ~ 280	Y1, Z1, 11	250	465	627	809
Z3	260 ~ 290	Z1, 11, 21	260	484	652	841

Notes:

- 1) Samsung maintains measurement tolerance of: luminous flux = $\pm 7\%$, CRI = ± 3
- 2) Calculated minimum flux values are for reference only

2. Product Code Information

<u>1</u>	<u>2</u>	<u>3</u>	4	5	<u>6</u>	<u>7</u>	<u>8</u>	<u>9</u>	<u>10</u>	<u>11</u>	<u>12</u>	13	14	15	16	17	18
S	C	P	8	U	T	F	1	H	E	L	1	U	K	M	3	4	E

Digit	PKG Information	Code	Specification																												
1 2 3	Samsung Chip Scale Package	SCP																													
4	CRI	7 8 9	CRI 70 CRI 80 CRI 90																												
5	CCT(K)	Y W V U T R Q P	2200K 2700K 3000K 3500K 4000K 5000K 5700K 6500K																												
6	Chip Shape	T	Square type																												
7 8 9	Product	F1H	Chip version																												
10 11 12	Product Purpose	EL1	FEC for lighting																												
13	CCT (K)	Y W V U T R Q P	2200K 2700K 3000K 3500K 4000K 5000K 5700K 6500K																												
14	MacAdam Step	K U	Full Bin for MacAdam 5-Step Full Bin for MacAdam 3-Step																												
15 16	Luminous Flux	F3 G3 H3 J3 K3 M3 N3 P3 Q3	<table border="0"> <tr> <td>90-120</td><td>F1</td><td>90-100</td><td rowspan="9"> </td></tr> <tr> <td>100-130</td><td>G1</td><td>100-110</td></tr> <tr> <td>110-140</td><td>H1</td><td>110-120</td></tr> <tr> <td>120-150</td><td>J1</td><td>120-130</td></tr> <tr> <td>130-160</td><td>K1</td><td>130-140</td></tr> <tr> <td>140-170</td><td>M1</td><td>140-150</td></tr> <tr> <td>150-180</td><td>N1</td><td>150-160</td></tr> <tr> <td>160-190</td><td>P1</td><td>160-170</td></tr> <tr> <td>170-200</td><td>Q1</td><td>170-180</td></tr> </table> <p>Digit 15: Min. spec Digit 16: The number of higher bin(s) from min. spec. e.g.: K1 = 130~140 lm, K3 = 130~160 lm</p>	90-120	F1	90-100		100-130	G1	100-110	110-140	H1	110-120	120-150	J1	120-130	130-160	K1	130-140	140-170	M1	140-150	150-180	N1	150-160	160-190	P1	160-170	170-200	Q1	170-180
90-120	F1	90-100																													
100-130	G1	100-110																													
110-140	H1	110-120																													
120-150	J1	120-130																													
130-160	K1	130-140																													
140-170	M1	140-150																													
150-180	N1	150-160																													
160-190	P1	160-170																													
170-200	Q1	170-180																													
17 18	Forward Voltage (Vf)	4E	2.7 ~ 3.1 V Bin Code 4A 2.7~2.9V AE 2.9~3.1V																												

a) Luminous Flux Bins ($I_F = 350 \text{ mA}$, $T_s = 85 \text{ }^\circ\text{C}$)

CRI/ Nominal CCT (K)	Flux rank												
	E1	F1	G1	H1	J1	K1	M1	N1	P1	Q1	R1	S1	
(min. flux)	80	90	100	110	120	130	140	150	160	170	180	190	
70	2700						SCP7WTF1HEL1W◇M34E						
	3000							SCP7VTF1HEL1V◇N34E					
	3500							SCP7UTF1HEL1U◇N34E					
	4000								SCP7TTF1HEL1T◇P34E				
	5000								SCP7RTF1HEL1R◇P34E				
	5700								SCP7QTF1HEL1Q◇P34E				
	6500								SCP7PTF1HEL1P◇N34E				
80	2200			SCP8YTF1HEL1Y◇H34E									
	2700					SCP8WTF1HEL1W◇K34E							
	3000					SCP8VTF1HEL1V◇K34E							
	3500						SCP8UTF1HEL1U◇M34E						
	4000						SCP8TTF1HEL1T◇M34E						
	5000							SCP8RTF1HEL1R◇N34E					
	5700							SCP8QTF1HEL1Q◇N34E					
6500							SCP8PTF1HEL1P◇M34E						
90	2700		SCP9WTF1HEL1W◇G34E										
	3000		SCP9VTF1HEL1V◇G34E										
	3500			SCP9UTF1HEL1U◇H34E									
	4000			SCP9TTF1HEL1T◇H34E									
	5000			SCP9RTF1HEL1R◇H34E									

Notes:

1) ◇ : MacAdam step code, K(MacAdam 5-step) / U(MacAdam 3-step)

b) Color Bins ($I_F = 350 \text{ mA}$, $T_s = 85 \text{ }^\circ\text{C}$)

Nominal CCT (K)	CRI (R_a)	Color Rank	Chromaticity Bins
2700, 3000, 3500, 4000, 5000, 5700, 6500	70		
2200, 2700, 3000, 3500, 4000, 5000, 5700, 6500	80	K (Full Bin for MacAdam 5-step) U (Full Bin for MacAdam 3-step)	☆K ☆U
2700, 3000, 3500, 4000, 5000	90		

Notes:

1) ☆ : Nominal CCT code, Y(2200K)/W(2700K)/V(3000K)/U(3500K)/T(4000K)/R(5000K)/Q(5700K)/P(6500K)

c) Voltage Bins ($I_F = 350 \text{ mA}$, $T_s = 85 \text{ }^\circ\text{C}$)

CRI (R_a)	Nominal CCT (K)	Product Code	Voltage Rank	Voltage Bin	Voltage Range (V)
			4E	4A	2.7 ~ 2.9
				AE	2.9 ~ 3.1

d) Chromaticity Region & Coordinates ($I_F = 350 \text{ mA}$, $T_s = 85 \text{ }^\circ\text{C}$)

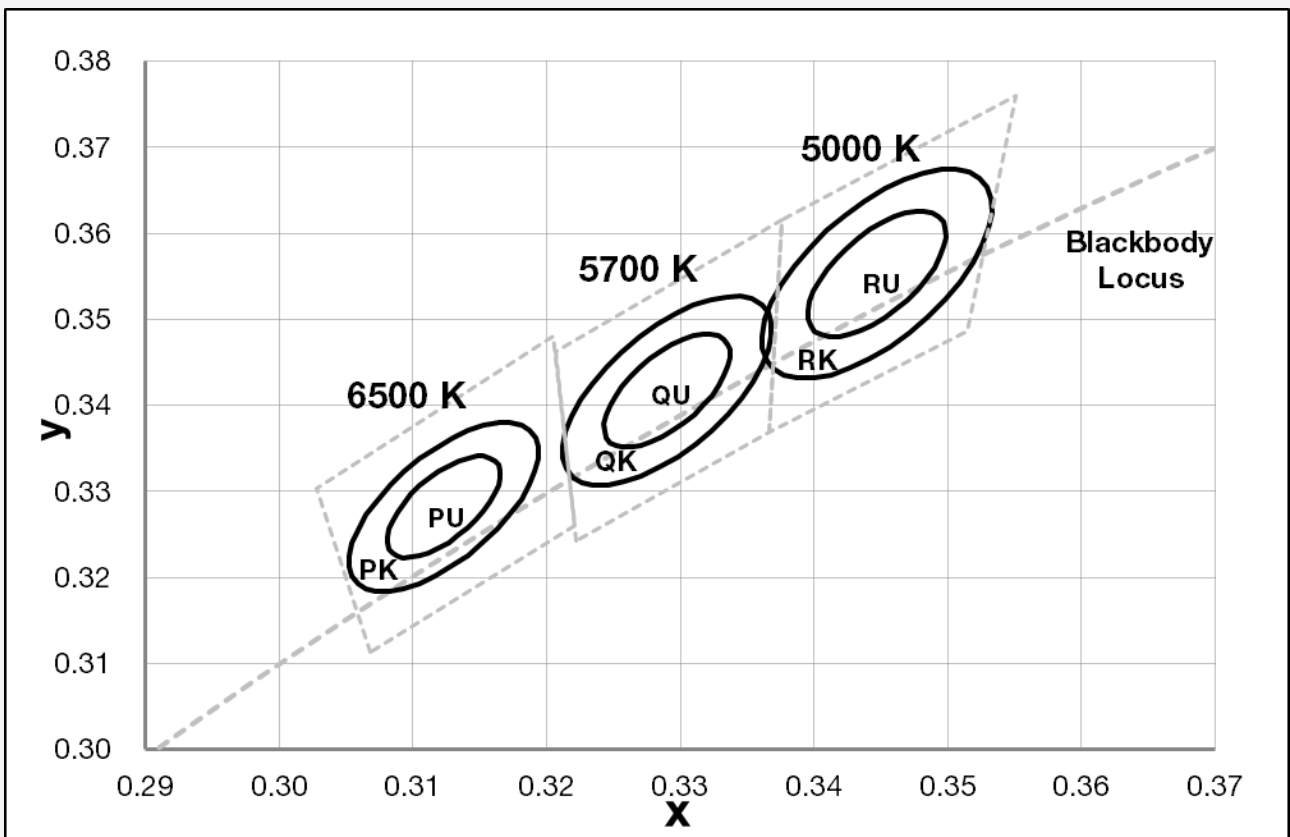
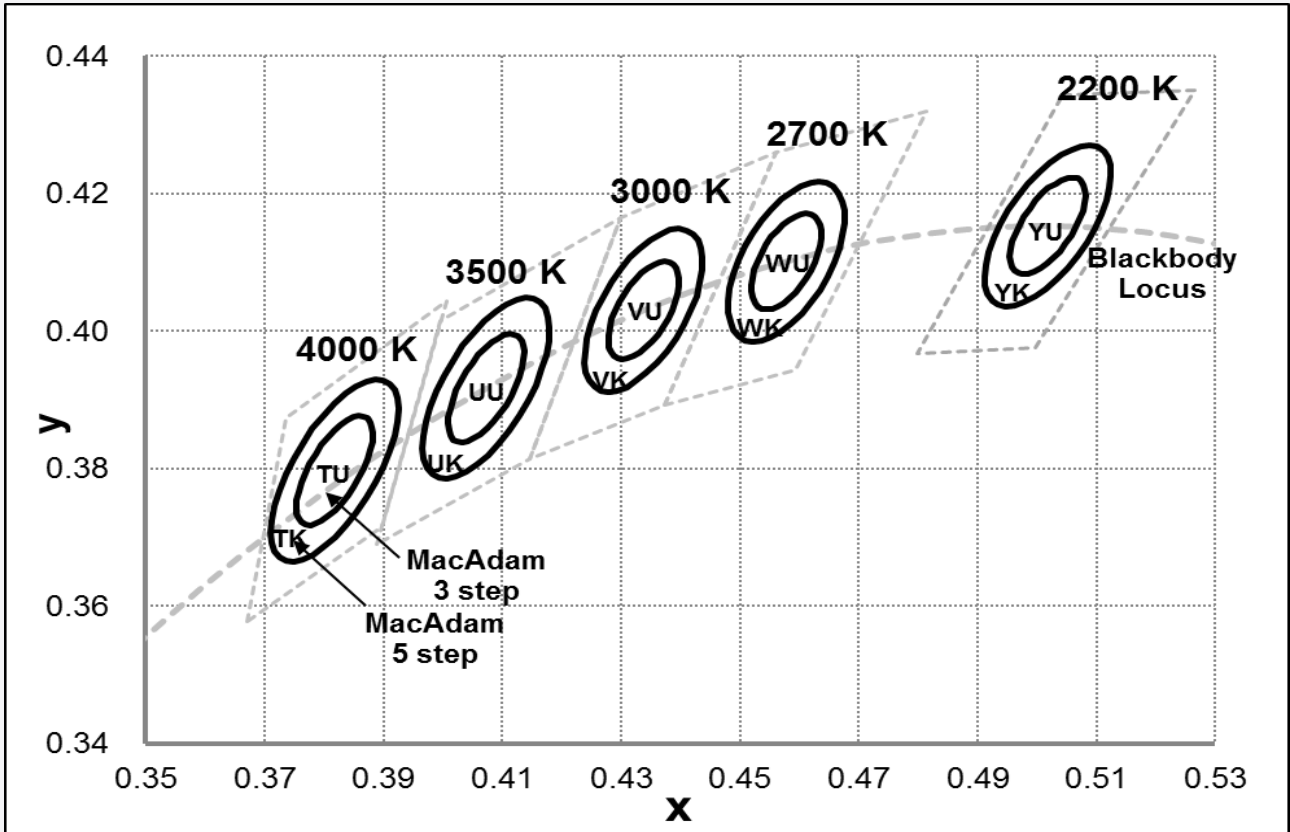

e) Chromaticity Region & Coordinates ($I_F = 350 \text{ mA}$, $T_s = 85 \text{ }^\circ\text{C}$)

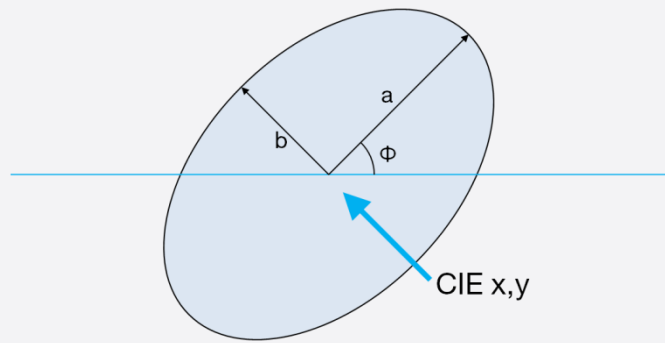

	CCT (K)	Center point		Major-axis	Minor-axis	Rotation
		CIE x	CIE y	a	b	Φ
3 step	2200	0.5018	0.4153	0.0086	0.0040	49.27
	2700	0.4578	0.4101	0.0081	0.0042	53.70
	3000	0.4338	0.4030	0.0083	0.0041	53.22
	3500	0.4073	0.3917	0.0093	0.0041	54.00
	4000	0.3818	0.3797	0.0094	0.0040	53.72
	5000	0.3447	0.3553	0.0082	0.0035	59.62
	5700	0.3287	0.3417	0.0075	0.0032	59.10
	6500	0.3123	0.3282	0.0067	0.0029	58.57
5 step	2200	0.5018	0.4153	0.0144	0.0066	49.27
	2700	0.4578	0.4101	0.0135	0.0070	53.70
	3000	0.4338	0.4030	0.0138	0.0068	53.22
	3500	0.4073	0.3917	0.0155	0.0068	54.00
	4000	0.3818	0.3797	0.0157	0.0067	53.72
	5000	0.3447	0.3553	0.0137	0.0058	59.62
	5700	0.3287	0.3417	0.0125	0.0053	59.10
	6500	0.3123	0.3282	0.0112	0.0048	58.57

Note:

Samsung maintains measurement tolerance of: $C_x, C_y = \pm 0.005$

3. Typical Characteristics Graphs

a) Spectrum Distribution ($I_F = 350 \text{ mA}$, $T_s = 85 \text{ }^\circ\text{C}$)

3000K/CRI70

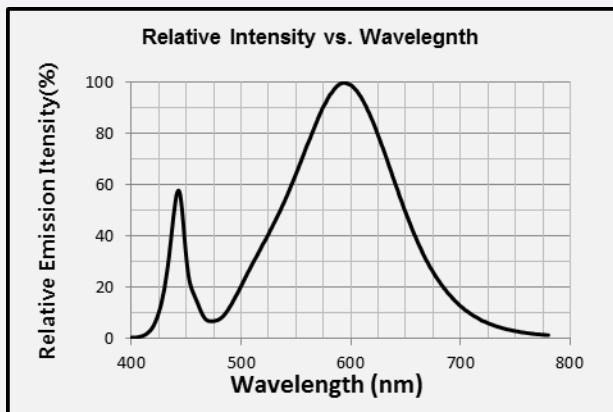

5000K/CRI70

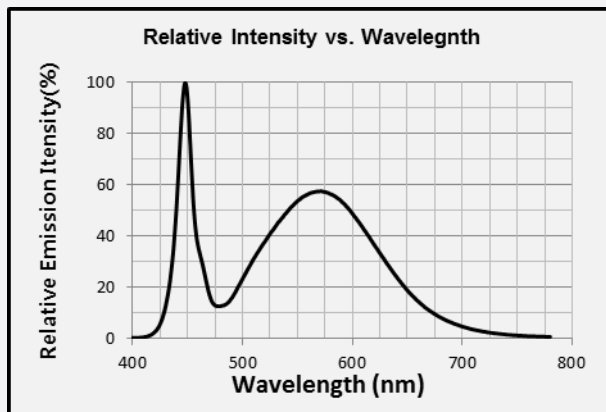

b) Forward Current Characteristics ($T_s = 85 \text{ }^\circ\text{C}$)

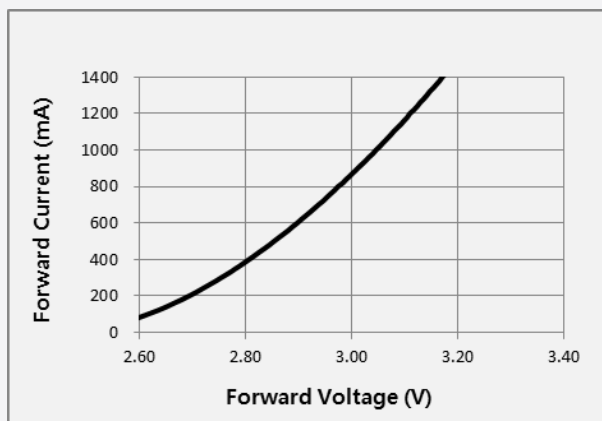
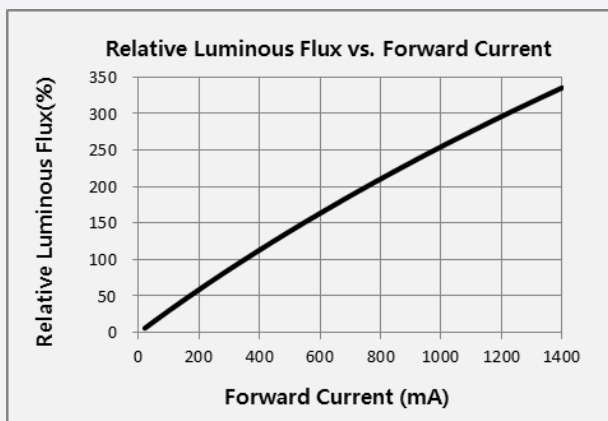

c) Temperature Characteristics ($I_F = 350 \text{ mA}$)

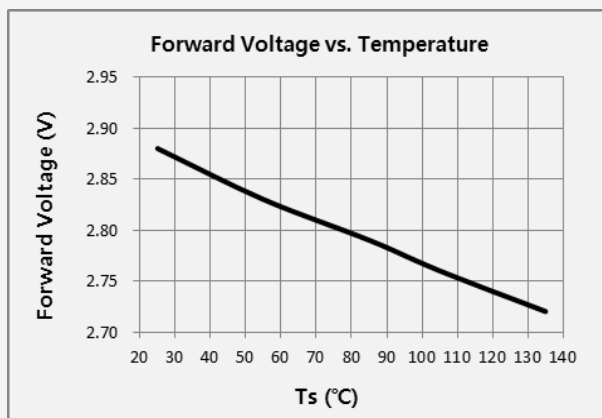
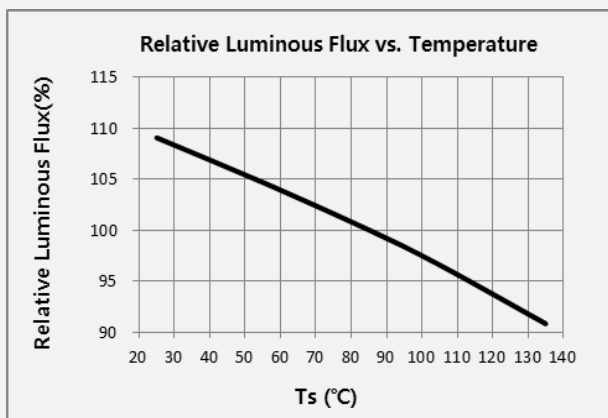

d) Color Shift Characteristics ($I_F = 350 \text{ mA}$, $T_s = 85 \text{ }^\circ\text{C}$)

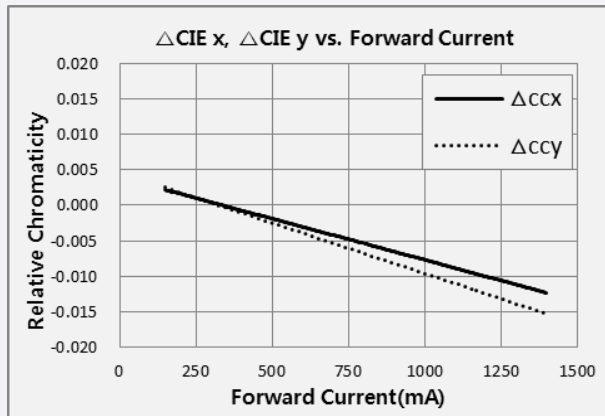
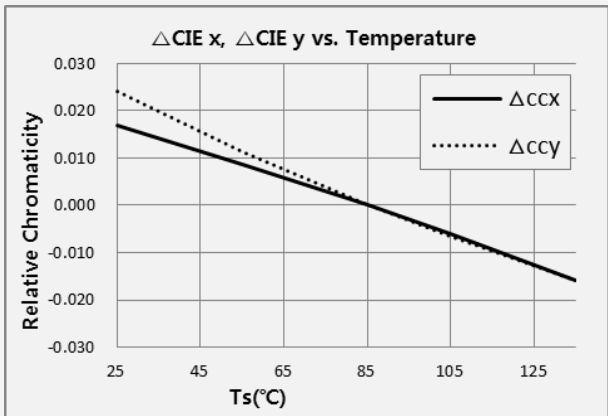

e) Derating Curve and Beam Angle Characteristics ($I_F = 350 \text{ mA}$, $T_s = 25 \text{ }^\circ\text{C}$)

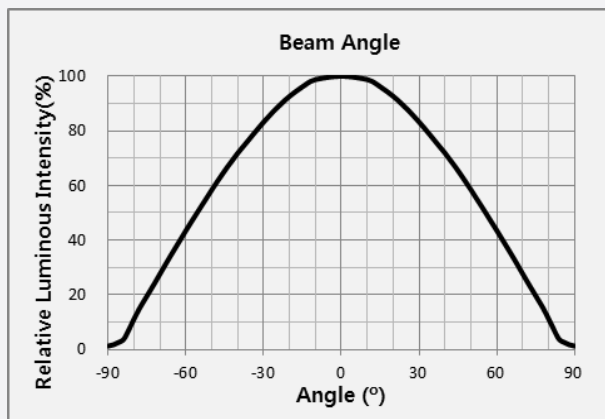
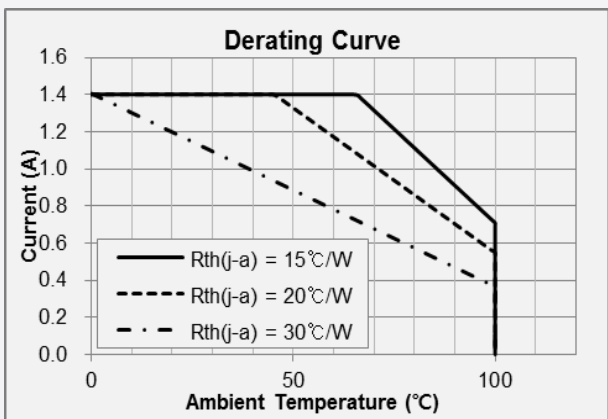

4. Outline Drawing & Dimension

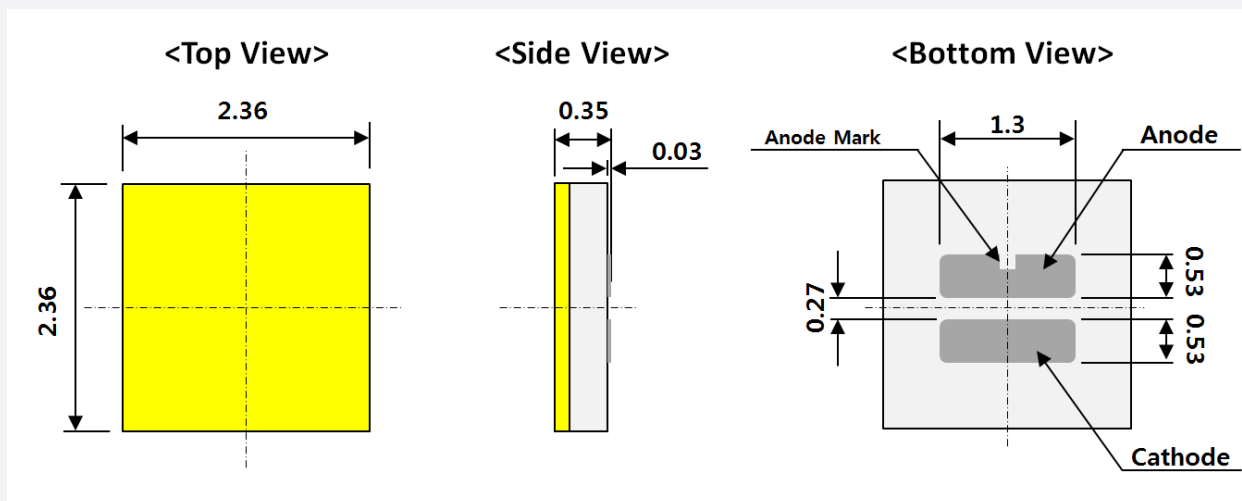

- Measurement unit: mm
- Tolerance: ± 0.13 mm

Precautions:

- 1) Pressure on the LEDs will influence to the reliability of the LEDs. Precautions should be taken to avoid strong pressure on the LEDs. Do not put stress on the LEDs during heating.
- 2) Re-soldering should not be done after the LEDs have been soldered. If re-soldering is unavoidable, LED's characteristics should be carefully checked before and after such repair.
- 3) Do not stack assembled PCBs together. Since materials of LEDs is soft, abrasion between two PCB assembled with LED might cause catastrophic failure of the LEDs.

5. Reliability Test Items & Conditions

a) Test Items

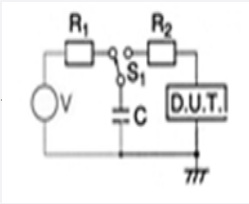
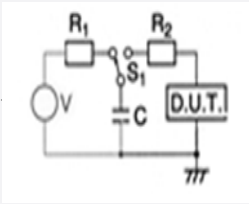
Test Item	Test Condition	Test Hour / Cycle
Room Temperature Life Test	25 °C, Derated maximum current	1000 h
High Temperature Life Test	85 °C, Derating maximum current	1000 h
High Temperature Humidity Life Test	60 °C, 90% RH, Derating maximum current	1000 h
Low Temperature Life Test	-40 °C, Derating maximum current	1000 h
Temperature Humidity Cycle Test	-10 °C ↔ 25 °C / Dry, 25 °C ↔ 65 °C 95% R.H. Derating maximum current	10 cycles
Powered Temperature Cycle Test	-40 °C / 85 °C each 20 min, 100 min transfer power on/off each 5 min, Derating maximum current	100 cycles
Thermal Shock	-45 °C / 15 min ↔ 125 °C / 15 min temperature change within 5 min	500 cycles
High Temperature Storage	120 °C	1000 h
Low Temperature Storage	-40 °C	1000 h
ESD (HBM)	 R ₁ : 10 MΩ R ₂ : 1.5 kΩ C: 100 pF V: ±2 kV	5 times
ESD (MM)	 R ₁ : 10 MΩ R ₂ : 0 C: 200 pF V: ±0.2 kV	5 times
Vibration Test	20~2000~20 Hz, 200 m/s ² , sweep 4 min X, Y, Z 3 direction, each 1 cycle	4 cycles
Mechanical Shock Test	1500 g, 0.5 ms 3 shocks each X-Y-Z axis	5 cycles

b) Criteria for Judging the Damage

Item	Symbol	Test Condition (T _s = 25 °C)	Limit	
			Min.	Max.
Forward Voltage	V _F	I _F = 350 mA	Init. Value * 0.9	Init. Value * 1.1
Luminous Flux	Φ _v	I _F = 350 mA	Init. Value * 0.7	Init. Value * 1.1

6. Soldering Conditions

a) Reflow Conditions (Pb free)

Reflow frequency: 2 times max.

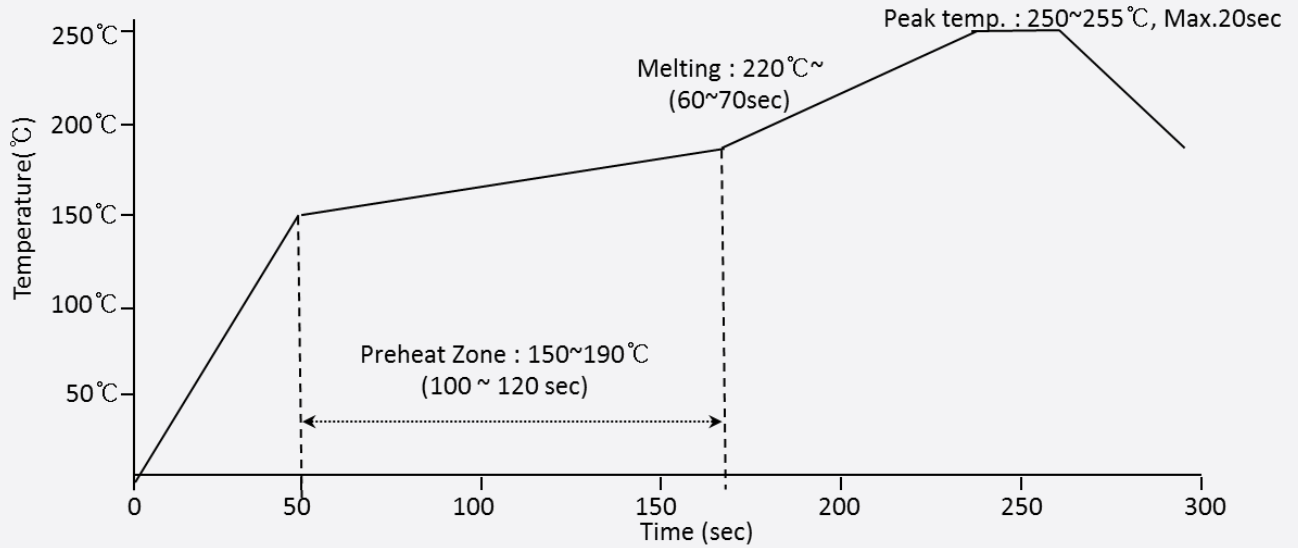

b) Manual Soldering Conditions

No more than 5 seconds @ max. 300 °C, under soldering iron.

7. Tape & Reel

a) Taping Dimension

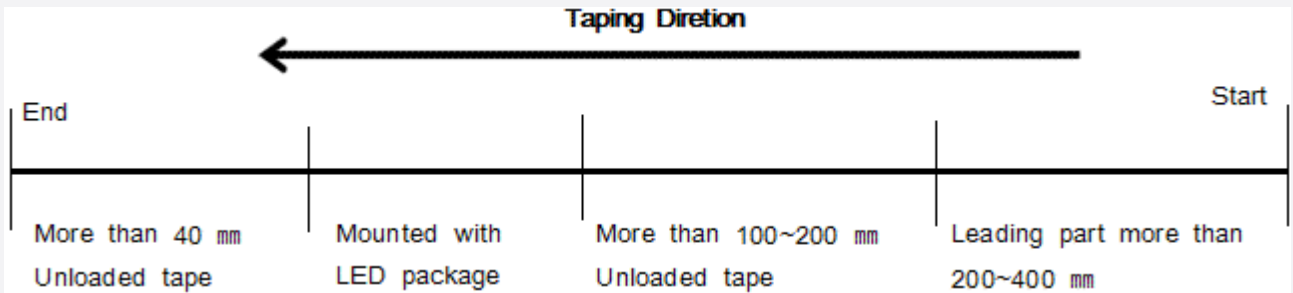
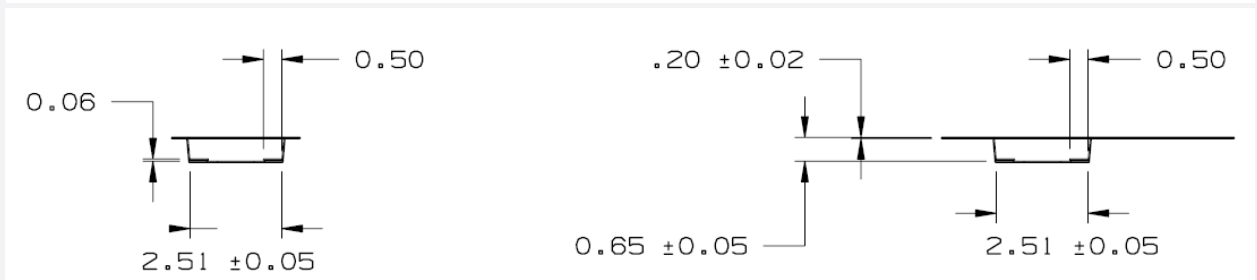
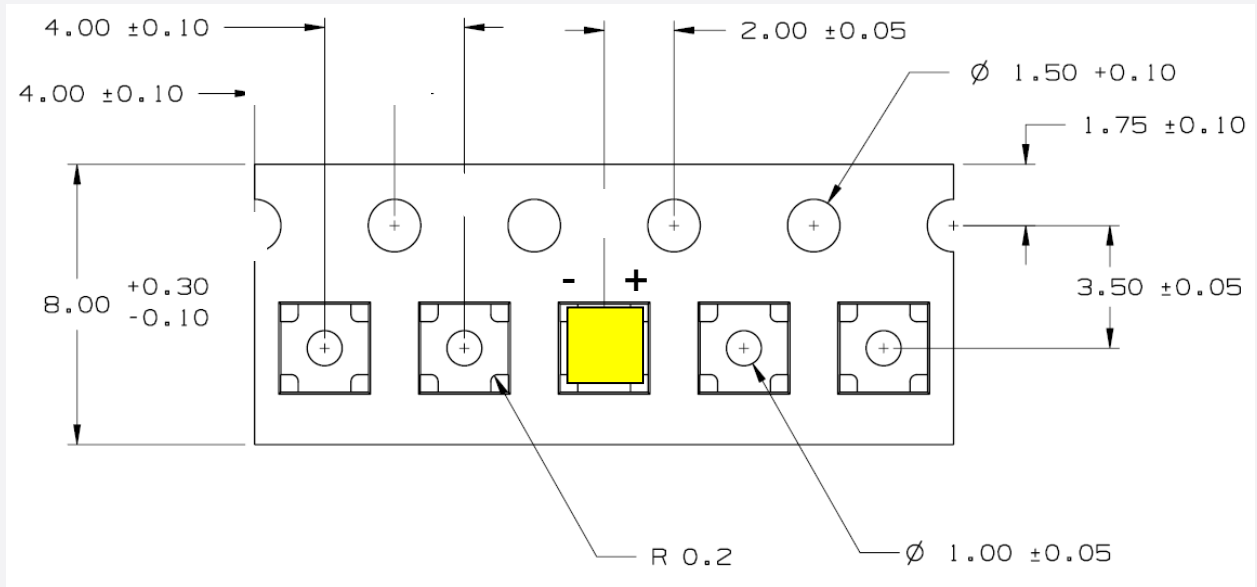

b) Reel Dimension

(unit: mm)

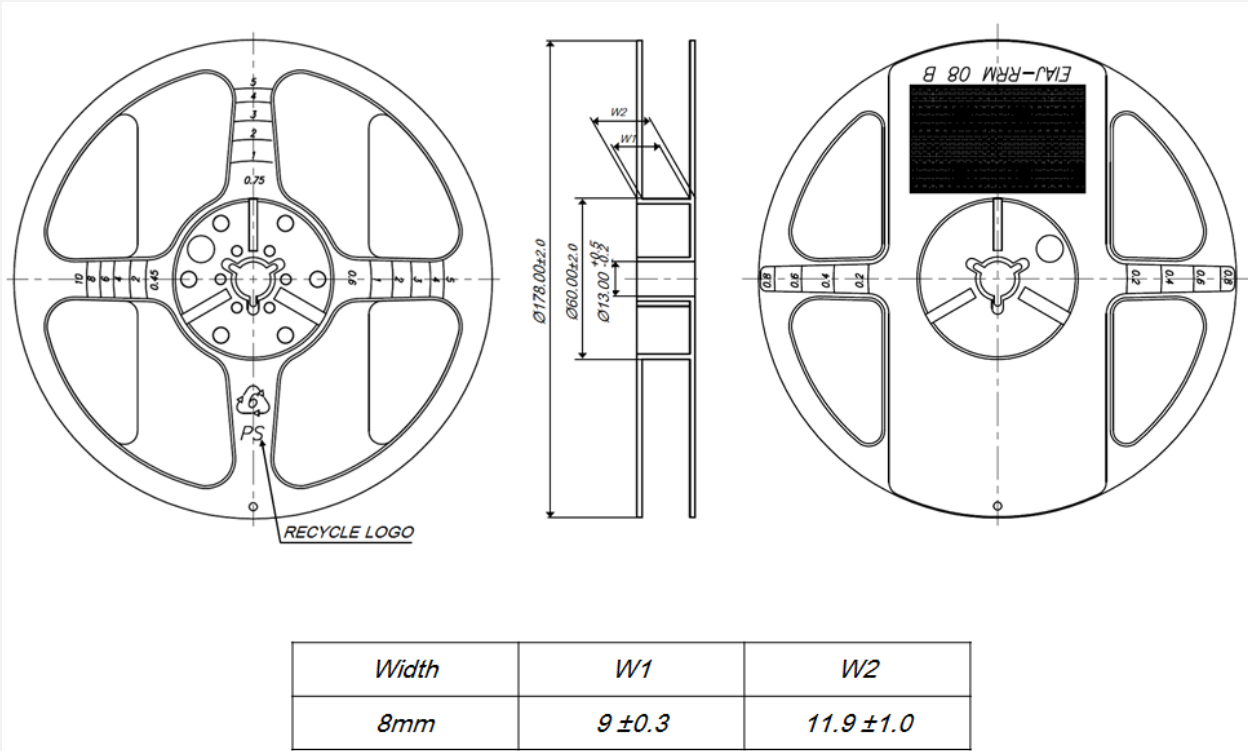

Notes:

- 1) Quantity: 2,000 Qty/reel
- 2) Cumulative tolerance: Cumulative tolerance / 10 pitches is ±0.2 mm
- 3) Adhesion strength of cover tape: Adhesion strength is 0.1-0.7 N when the cover tape is turned off from the carrier tape at 10° angle to the carrier tape
- 4) Packaging: P/N, Manufacturing data code no. and quantity are indicated on the aluminum packing bag

8. Label Structure

a) Label Structure

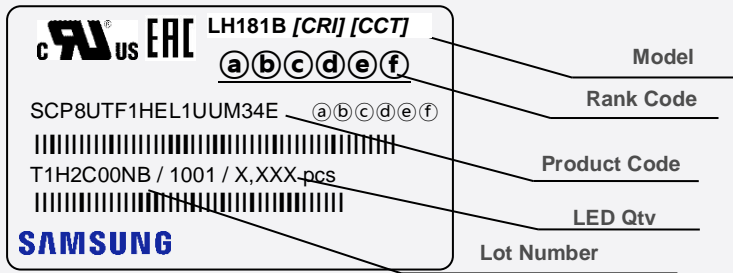

Note: Denoted Bin ID and product code above is only an example

Rank Code:

- ⒶⒷ: Chromaticity bin (refer to page 6)
- ⒸⒹ: Luminous Flux bin (refer to page 6,7)
- ⒺⒻ: Voltage bin (refer to page 6,9)

b) Lot Number

The lot number is composed of the following characters:



- ① : T (T: Taping ID)
- ② : 1 (1: LED Manufacture Line)
- ③ : Year (G:2016, H: 2017, ...)
- ④ : Month (1, 2, ..., 7: July, ..., A: Oct., B: Nov., C: Dec.)
- ⑤ : Day (1~9, A: 10, ..., K: 20, ..., U: 30, V:31)
- ⑥⑦⑧⑨ : Product serial number (0001 ~ 9999)

9. Packing Structure



a) Packing Process

Reel

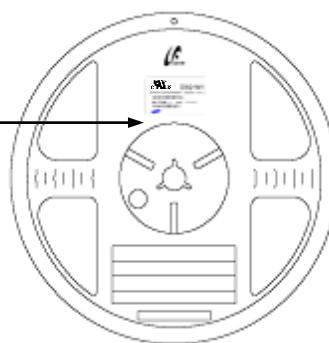
LH181B [CRI] [CCT]
UUN14E
 SCP8UTF1HEL1UUM34E UUN14A
 T1H2C00NB / 1001 / X,XXX pcs

SAMSUNG



Aluminum Vinyl Packing Bag



LH181B [CRI] [CCT]
UUN14E
 SCP8UTF1HEL1UUM34E UUN14A
 T1H2C00NB / 1001 / X,XXX pcs

SAMSUNG



Outer Box

Material: Paper SW(B)

Type	Size (mm)			Note
	(a)	(b)	(c)	
7 inch	245 ± 5	220 ± 5	182 ± 5	Up to 7 reels

LH181B [CRI] [CCT]
UUN14E
 SCP8UTF1HEL1UUM34E UUN14A
 T1H2C00NB / 1001 / X,XXX pcs

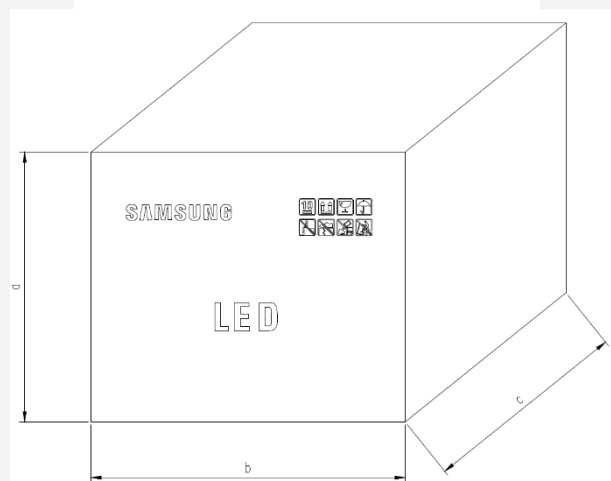
SAMSUNG



b) Aluminum Vinyl Packing Bag



CAUTION

This bag contains
MOISTURE SENSITIVE DEVICES

LEVEL
2a

c  **us**  **LH181B [CRI] [CCT]**
UUN14E

SCP8UTF1HEL1UKM34E UUN14A
 T1H2C00NB / 1001 / X,XXX pcs

SAMSUNG





ATTENTION
OBSERVE PRECAUTIONS
FOR HANDLING
ELECTROSTATIC
SENSITIVE
DEVICES



주의 사항

이 알루미늄 지퍼 백은 습기 및 정전기로부터 제품을 보호하기 위하여 제작되었습니다. 개봉 후에는 즉시 솔더 작업을 실시하는 것을 권장합니다.

습기 및 정전기로부터 제품을 보호 하기 위해서 개봉 후 사용하지 않는 자재는 본 팩에 넣어 보관 하시기 바랍니다. 사용하지 않는 자재를 본 팩에 넣을 때는 반드시 동봉된 드라이 팩과 함께 넣고 지퍼부분을 완전하게 밀봉하여 주시기 바랍니다.

Important

This Al Zipper bag is designed to protect the enclosed products from moisture and ESD. Once opened, the products should be soldered onto the printed circuit board immediately. When not in use, please do not leave the products unprotected by the Al Zipper Bag. To repack unused products., please ensure the zip-lock is completely sealed with the dry pack left inside.

c) Silica Gel & Humidity Indicator Card inside Aluminum Vinyl Bag

DESICCANT
SILICA
DO NOT
REUSE
SILICA GEL

HUMISAFE™

10% 20% 30% 40% 50% 60%



READ AT TOP OF GREEN COLOR
CHANGE BETWEEN YELLOW AND GREEN

**HUMIDITY INDICATOR
COBALT-FREE**

Warning if Green
Change Desiccant

GP&E Co., Ltd.
6CF-60NS

10. Precautions in Handling & Use

- 1) For over-current protection, users are recommended to apply resistors connected in series with the LEDs to mitigate sudden change of the forward current caused by shift of forward voltage.
- 2) This device should not be used in any type of fluid such as water, oil, organic solvent, etc. When cleaning is required, IPA is recommended as the cleaning agent. Some solvent-based cleaning agent may damage the silicone resins used in the device.
- 3) When the device is in operation, the forward current should be carefully determined considering the maximum ambient temperature and corresponding junction temperature.
- 4) LEDs must be stored in a clean environment.
- 5) After storage bag is opened, device subjected to soldering, solder reflow, or other high temperature processes must be:
 - a. Mounted within 672 hours (28 days) at an assembly line with a condition of no more than 30 °C / 60 % RH, or
 - b. Stored at <10 % RH
- 6) Repack unused devices with anti-moisture packing, fold to close any opening and then store in a dry place.
- 7) Devices require baking before mounting, if humidity card reading is >60 % at 23 ± 5 °C.
- 8) Devices must be baked for 1 hour at 60 ± 5 °C, if baking is required.
- 9) The LEDs are sensitive to the static electricity and surge current. It is recommended to use a wrist band or anti-electrostatic glove when handling the LEDs. If voltage exceeding the absolute maximum rating is applied to LEDs, it may cause damage or even destruction to LED devices. Damaged LEDs may show some unusual characteristics such as increase in leakage current, lowered turn-on voltage, or abnormal lighting of LEDs at low current.
- 10) VOCs (Volatile Organic Compounds) can be generated from adhesives, flux, hardener or organic additives used in luminaires (fixtures). Transparent LED silicone encapsulant is permeable to those chemicals and they may lead to a discoloration of encapsulant when they exposed to heat or light. This phenomenon can cause a significant loss of light emitted (output) from the luminaires. In order to prevent these problems, we recommend users to know the physical properties of materials used in luminaires and they must be carefully selected.

Legal and additional information.

[About Samsung Electronics Co., Ltd.](#)

Samsung Electronics Co. Ltd inspires the world and shapes the future with transformative ideas and technologies. The company is redefining the worlds of TVs, smartphones, wearable devices, tablets, digital appliances, network systems, and semiconductor and LED solutions. For the latest news, please visit the Samsung Newsroom at <http://news.samsung.com>.

Copyright © 2020 Samsung Electronics Co., Ltd. All rights reserved.
Samsung is a registered trademark of Samsung Electronics Co., Ltd.
Specifications and designs are subject to change without notice. Non-metric weights and measurements are approximate. All data were deemed correct at time of creation. Samsung is not liable for errors or omissions. All brand, product, service names and logos are trademarks and/or registered trademarks of their respective owners and are hereby recognized and acknowledged.

Samsung Electronics Co., Ltd.
1, Samsung-ro
Giheung-gu
Yongin-si, Gyeonggi-do, 17113
KOREA

www.samsungled.com

SAMSUNG