

50, 40 & 30 W Programmable CC Class 2 / Class II LED Driver with Tri-Mode Dimming™ (TRIAC, ELV & 0-10 V)

Nominal Input Voltage	Max. Output Power	Efficiency	Max. Case Temperature	THD	Power Factor	Dimming Method	Dimming Range	Startup Time
120 & 277 Vac, 220 to 240 Vac	50 W	up to 90% typical	90°C (measured at the hot spot)	< 20%	> 0.9	Forward-Phase, Reverse-Phase & Programmable 0 - 10V	1 - 100% (% of Iout)	300 ms typical

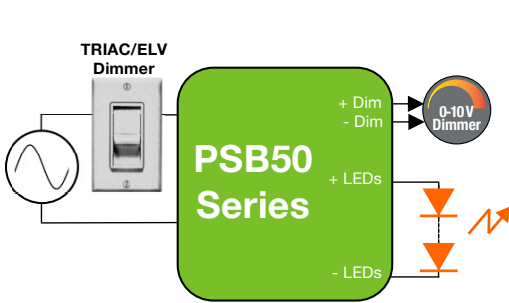

Side Leads
 L 98.5 x W 26.0 x H 21.85 mm
 (L 3.88 x W 1.02 x H 0.86 in.)
 PSBXXW Models



Terminal Blocks: "-T" Suffix
 L 154.2 x W 26.2 x H 21.85 mm
 (L 6.07 x W 1.03 x H 0.86 in.)

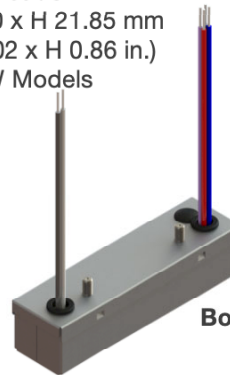

Bottom Leads with Studs: "-S" Suffix
 L 98.5 x W 26.0 x H 23.7 mm
 (L 3.88 x W 1.02 x H 0.93 in.)

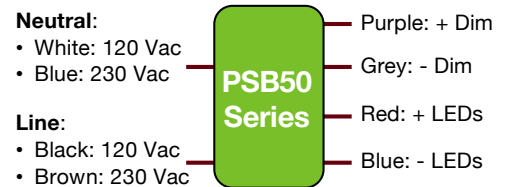

Wiring Diagram

FEATURES

- Non-linear 0-10V dimming profile with dim-to-off pre-loaded by default (10V to 9.0V=100%, 1.5V to 0.7V=1%, <0.7V=dim-to-off)
- UL Class P
- Class 2 output
- Class II power supply
- Lifetime: 50,000 hours @ $T_c \leq 75^\circ \text{C}$
- 90°C maximum case hot spot temperature
- IP20-rated case with silicone-based potting
- No TRIAC/ELV dimming for PSBXXE models, only 0-10V dimming
- Surge protection:
 - IEC61000-4-5: 2 kV line to line/2 kV line to earth
 - 2.5 kV ring wave: ANSI/IEEE c62.41.1-2002 & c62.41.2-2002 category A
- Complies with ENERGY STAR®, DLC (DesignLight Consortium®) and CA Title 24 technical requirements
- Additional safety approvals when using the optional strain reliefs for models with "-T" suffix



PROGRAMMING

- Serial port programming
 - Current: 100% to 50% in each voltage range
 - Data log read: SKU, S/N, lot code, hours of operation, FW rev., fault events: power failure, thermal
- Fully programmable and selectable 0-10V dimming profiles: Non-linear with dim-to-off, Logarithmic, Non-Linear without dim-to-off.

APPLICATIONS

- Commercial & residential lighting
- Architectural lighting
- Indoor Lighting



50, 40 & 30 W Programmable CC Class 2 / Class II LED Driver with Tri-Mode Dimming™ (TRIAC, ELV & 0-10 V)

1 - ORDERING INFORMATION

Part Number	Nominal Input Voltage (Vac)	Max Output Power (W)	Iout (mA)	Vout Min. (Vdc)	Vout Nom. (Vdc)	Vout Max. (Vdc)	Open Loop (No Load) Voltage (Vdc)	Comments
120 & 277 VAC NOMINAL INPUT VOLTAGE								
PSB30W								
PSB30W-0700-42	120 & 277	29.4	350 to 700	28	37.8	42	50	Side leads
PSB30W-1050-27	120 & 277	28.4	525 to 1050	18	24.3	27	35	Side leads
PSB30W-0700-34	120 & 277	23.8	350 to 700	23	30.6	34	44.2	Side leads
PSB40W								
PSB40W-1400-27	120 & 277	37.8	700 to 1400	18	24.3	27	35	Side leads
PSB50W								
PSB50W-0550-85	120 & 277	46.8	275 to 550	57	76.5	85	100	Side leads
PSB50W-0850-56	120 & 277	47.6	425 to 850	38	50.4	56	60	Side leads
PSB50W-1200-42	120 & 277	50.4	600 to 1200	28	37.8	42	50	Side leads
PSB50W-1400-34	120 & 277	47.6	700 to 1400	23	30.6	34	44.2	Side leads
120 & 277 VAC NOMINAL INPUT VOLTAGE								
PSB30W								
PSB30W-0700-42-S	120 & 277	29.4	350 to 700	28	37.8	42	50	Bottom leads with studs
PSB30W-1050-27-S	120 & 277	28.4	525 to 1050	18	24.3	27	35	Bottom leads with studs
PSB30W-0700-34-S	120 & 277	23.8	350 to 700	23	30.6	34	44.2	Bottom leads with studs
PSB40W								
PSB40W-1400-27-S	120 & 277	37.8	700 to 1400	18	24.3	27	35	Bottom leads with studs
PSB50W								
PSB50W-0550-85-S	120 & 277	46.8	275 to 550	57	76.5	85	100	Bottom leads with studs
PSB50W-0850-56-S	120 & 277	47.6	425 to 850	38	50.4	56	60	Bottom leads with studs
PSB50W-1200-42-S	120 & 277	50.4	600 to 1200	28	37.8	42	50	Bottom leads with studs
PSB50W-1400-34-S	120 & 277	47.6	700 to 1400	23	30.6	34	44.2	Bottom leads with studs
220 to 240 VAC NOMINAL INPUT VOLTAGE								
PSB30E								
PSB30E-0700-42	220 to 240	29.4	350 to 700	28	37.8	42	50	Side leads
PSB50E								
PSB50E-1200-42	220 to 240	50.4	600 to 1200	28	37.8	42	50	Side leads
220 to 240 VAC NOMINAL INPUT VOLTAGE								
PSB30E								
PSB30E-0700-42-T	220 to 240	29.4	350 to 700	28	37.8	42	50	Terminal blocks
PSB30E-1050-27-T	220 to 240	28.4	525 to 1050	18	24.3	27	35	Terminal blocks
PSB30E-0700-34-T	220 to 240	23.8	350 to 700	23	30.6	34	44.2	Terminal blocks
PSB40E								
PSB40E-1400-27-T	220 to 240	37.8	700 to 1400	18	24.3	27	35	Terminal blocks
PSB50E								
PSB50E-0550-85-T	220 to 240	46.8	275 to 550	57	76.5	85	100	Terminal blocks
PSB50E-0850-56-T	220 to 240	47.6	425 to 850	38	50.4	56	60	Terminal blocks
PSB50E-1200-42-T	220 to 240	50.4	600 to 1200	28	37.8	42	50	Terminal blocks
PSB50E-1400-34-T	220 to 240	47.6	700 to 1400	23	30.6	34	44.2	Terminal blocks

Notes:

- For each model, **the default output current setting is the MINIMUM current.**
 Example: the default output current setting for the PSB50W-1200-42 is 600 mA.
- For additional options of output current and output voltage, contact your sales representative or send an email to: SaveEnergy@erp-power.com
- Please order the programming cable using the part number PROG-JACK-USB.
- Strain reliefs for "-T" models can be ordered using part number SR2.

Programming Cable

Part number: PROG-JACK-USB



50, 40 & 30 W Programmable CC Class 2 / Class II LED Driver with Tri-Mode Dimming™ (TRIAC, ELV & 0-10 V)

2 - INPUT SPECIFICATION (@25° C ambient temperature)

	Units	Minimum	Typical	Maximum	Notes
Input Voltage Range (Vin) - PSBXXW models	Vac	90	120 & 277	305	<ul style="list-style-type: none"> The rated output current for each model is achieved at Vin≥108 Vac & at Vin≥249 Vac for PSBXXW models, and at Vin≥209 Vac for PSBXXE models. At nominal load
- PSBXXE models		198	230	264	
Input Frequency Range - PSBXXW models	Hz	47	60	63	
- PSBXXE models		47	50	53	
Input Current (Iin)	A			0.5 A @ 120 Vac 0.28 A @ 230 Vac 0.23 A @ 277 Vac	
Power Factor (PF)		0.9	> 0.9		<ul style="list-style-type: none"> At nominal input voltage and with nominal LED voltage From 100% to 50% of rated power
Inrush Current	A	Meets NEMA-410 requirements			<ul style="list-style-type: none"> At any point on the sine wave and 25°C Active limiting inrush current is available as an option. Please contact your ERP representative or send an email to SaveEnergy@erp-power.com.
Leakage Current	mA			0.3 mA @ 120 Vac 0.6 mA @ 230 Vac 0.7 mA @ 277 Vac	Measured per IEC60950-1
Input Harmonics	Complies with IEC61000-3-2 for Class C equipment				
Total Harmonics Distortion (THD)				20%	<ul style="list-style-type: none"> At nominal input voltage and nominal LED voltage From 100% to 50% of rated power Complies with DLC (Design Light Consortium) technical requirements
Efficiency	%	-	up to 90%	-	Measured with nominal input voltage, a full sinusoidal wave form and without dimmer attached.
Isolation	The AC input to the main DC output is isolated.				

3 - MAIN OUTPUT SPECIFICATION (@25° C ambient temperature)

	Units	Minimum	Typical	Maximum	Notes
Output Voltage (Vout)	Vdc				See ordering information for details
Output Current (Iout)	mA				<ul style="list-style-type: none"> See ordering information for details The rated output current for each model is achieved at Vin≥108 Vac & at Vin≥249 Vac for PSBXXW models, and at Vin≥209 Vac for PSBXXE models.
Output Current Regulation	%	-5	±2.5	5	<ul style="list-style-type: none"> At nominal AC line voltage Includes load and current set point variations
Output Current Overshoot	%	-	-	10	The driver does not operate outside of the regulation requirements for more than 500 ms during power on with nominal LED load and without dimmer.
Ripple Current	≤ 10% of rated output current for each model				<ul style="list-style-type: none"> Measured at nominal LED voltage and nominal input voltage without dimming Calculated in accordance with the IES Lighting Handbook, 9th edition
0-10V Dimming Range (% of Iout)	%	1		100	<ul style="list-style-type: none"> The dimming range is dependent on each specific dimmer. It may not be able to achieve 1% dimming with some dimmers. Dimming performance is optimal when the driver is operated at its nominal output voltage matching the LED nominal Vf (forward voltage). Dimming performance may vary when the driver is operated near its minimum output voltage.
TRIAC/ELV Dimming Range (% of Iout)	%	1		100	<ul style="list-style-type: none"> Dimming performance is optimal when the driver is operated at its nominal output voltage matching the LED nominal Vf (forward voltage). Due to variances in the performance of TRIAC/ELV dimmers, PSB use with TRIAC/ELV dimming is recommended when a PSB driver is limited to being programmed from 80%-100% of maximum output current. If using a PSB driver with a TRIAC/ELV while programmed from 50%-79% of maximum output current, ERP recommends use of the PHB series driver.
Start-up Time	ms		300	500	<ul style="list-style-type: none"> Without any dimmer attached, and at nominal input voltages and nominal load Measured from application of AC line voltage to 100% light output Complies with ENERGY STAR® luminaire specification and CA Title 24
Isolation	The main DC output is certified and tested per UL8750 Class 2 or LED Class 2				

50, 40 & 30 W Programmable CC Class 2 / Class II LED Driver with Tri-Mode Dimming™ (TRIAC, ELV & 0-10 V)

4 - 0-10 V DIMMING CONTROL (@25° C ambient temperature)

In the PSB50/40/30 series, several 0-10V dimming profiles can be selected, such as a logarithmic profile, a non-linear profile with 1% minimum dimming and dim-to-off, and a non-linear profile with 10% minimum dimming and no dim-to-off. Furthermore, every point in the non-linear dimming profile can be programmed using the programming software.

By default, the non-linear profile with 1% minimum dimming and dim-to-off (show in figure 1) is pre-loaded in the PSB50/40/30 series.

	Units	Minimum	Typical	Maximum	Notes
+Dim Signal, -Dim Signal					The PSB50/40/30 series operate only with 0-10V dimmers that sink current. The method to dim the output current of the driver is done via the +Dim/-Dim Signal pins. The +Dim/-Dim signal pins can be used to adjust the output setting via a standard commercial wall dimmer, an external control voltage source (0 to 10 Vdc), or a variable resistor when using the recommended number of LEDs. The dimming input permits 1% to 100% dimming.
Dimming Profile (see figure 1)					100% of output current between 10 V and 9.0 V, Linear between 9.0 V and 1.5 V, 1% of output current between 1.5 V and 0.7 V, Output current off below 0.7 V.
Dimming Range	%	1		100	As a percent of the output current
High Level Voltage - A	V	8.9	9.0	9.1	
Low Level Voltage - B	V		1.5		
Dim to Off - C	V	0.6	0.7	0.8	
Dim to Off Hysteresis - D	V			+0.2	
Current Supplied by the +Dim Signal Pin	mA			1	
Output Current Tolerance While Being Dimmed	%			±8	The tolerance of the output current while being dimmed is ≤ +/-8% until down to 1.5V.
Minimum Dimming Tolerance	%	0.8	1	2	
Isolation					The 0-10 V circuit is isolated from the AC input.

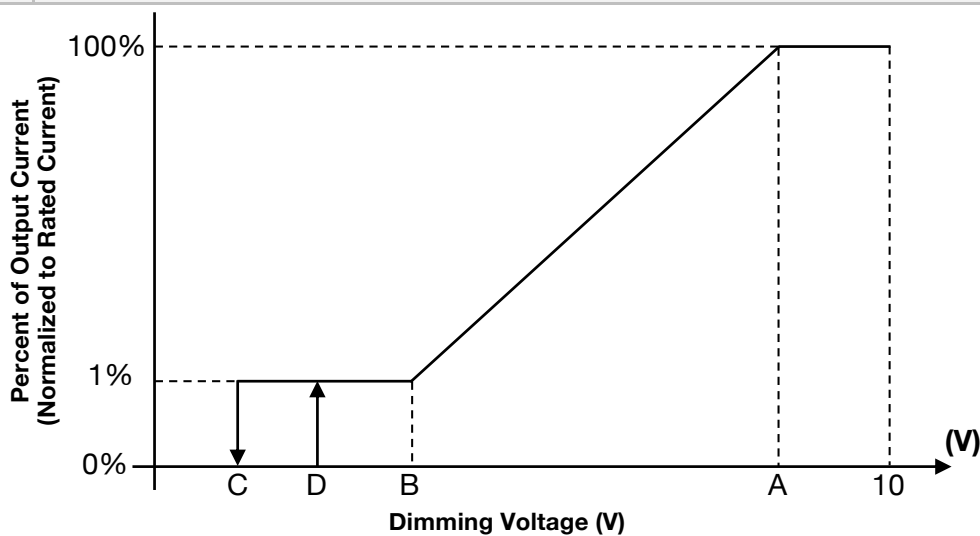

Figure 1

50, 40 & 30 W Programmable CC Class 2 / Class II LED Driver with Tri-Mode Dimming™ (TRIAC, ELV & 0-10 V)



5 - ENVIRONMENTAL CONDITIONS

	Units	Minimum	Typical	Maximum	Notes
Operating Ambient Temperature (Ta)	°C	-10		50	50°C is the non-derated temperature (Refer to section 8 "Output power de-rating at higher temperatures").
Maximum Case Temperature (Tc)	°C			+90	Case temperature measured at the hot spot •tc (see label in page 11)
Storage Temperature	°C	-40		+85	
Humidity	%	5	-	95	Non-condensing
Cooling	Convection cooled				
Acoustic Noise	dBA			24	Measured at a distance of 1 meter, without dimmer
Mechanical Shock Protection	per EN60068-2-27				
Vibration Protection	per EN60068-2-6 & EN60068-2-64				
MTBF	> 200,000 hours when operated at nominal input and output conditions, and at Tc ≤ 75°C				
Lifetime	50,000 hours at Tc ≤ 75°C maximum case hot spot temperature (see hot spot •tc on label in page 11)				

6 - EMC COMPLIANCE AND SAFETY APPROVALS

EMC Compliance		
Conducted and Radiated EMI	•PSBXXW models: Compliant with FCC CFR Title 47 Part 15 Class B at 120 Vac & Class A at 277 Vac •PSBXXE models: Compliant with EN55015 (CISPR 15) at 220, 230, and 240 Vac	
Harmonic Current Emissions	IEC61000-3-2	For Class C equipment
Voltage Fluctuations & Flicker	IEC61000-3-3	
Immunity Compliance	ESD (Electrostatic Discharge)	IEC61000-4-2 6 kV contact discharge, 8 kV air discharge, level 3
	RF Electromagnetic Field Susceptibility	IEC61000-4-3 3 V/m, 80 - 1000 MHz, 80% modulated at a distance of 3 meters
	Electrical Fast Transient	IEC61000-4-4 ± 2 kV on AC power port for 1 minute, ±1 kV on signal/control lines
	Surge	IEC61000-4-5 ± 2 kV line to line (differential mode) / ± 2 kV line to common mode ground (tested to secondary ground) on AC power port, ±0.5 kV for outdoor cables ANSI/IEEE c62.41.1-2002 & c62.41.2-2002 category A, 2.5 kV ring wave
	Conducted RF Disturbances	IEC61000-4-6 3V, 0.15-80 MHz, 80% modulated
	Voltage Dips	IEC61000-4-11 >95% dip, 0.5 period; 30% dip, 25 periods; 95% reduction, 250 periods

Safety Agency Approvals	
UL	PSBXXW models: UL8750 listed Class 2 (except PSB50W-0550-85)
cUL	PSBXXW models: CAN/CSA C22.2 No. 250.13-14 LED equipment for lighting applications
CE	PSBXXE models: IEC61347-2-13 electronic control gear for LED Modules & EN55015 (EMC compliance)
CB	PSBXXE models
ENEC	PSBXXE models

Safety					
	Units	Minimum	Typical	Maximum	Notes
Hi Pot (High Potential) or Dielectric voltage-withstand - PSBXXW models	Vdc	4400			•Tested at the RMS voltage equivalent of 3100 Vac •Meets class II reinforced/double insulation 
- PSBXXE models		4242			•Tested at the RMS voltage equivalent of 3000 Vac •Meets class II reinforced/double insulation 

50, 40 & 30 W Programmable CC Class 2 / Class II LED Driver with Tri-Mode Dimming™ (TRIAC, ELV & 0-10 V)

7 - PROTECTION FEATURES

Input Over Current Protection

The PSB series incorporates a primary AC line fuse for input over current protection to prevent damage to the LED driver and meet product safety requirements as outlined in Section 6.

Short Circuit and Over Current Protection

The PSB50/40/30 series is protected against short-circuit such that a short from any output to return shall not result in a fire hazard or shock hazard. The driver shall hiccup as a result of a short circuit or over current fault. Removal of the fault will return the driver to within normal operation. The driver shall recover, with no damage, from a short across the output for an indefinite period of time.

Internal Over temperature Protection

The PSB50/40/30 series is equipped with internal temperature sensor on the primary power train. Failure to stay within the convection power rating will result in the power supply reducing the available current (fold back) below the programmed amount. The main output current will be restored to the programmed value when the temperature of the built-in temperature sensor cools adequately.

Output Open Load Protection

When the LED load is removed, the output voltage of the PSB50/40/30 series is typically limited to 1.3 times the maximum output voltage of each model.

8 - OUTPUT POWER DE-RATING AT ELEVATED TEMPERATURES

The PSB50/40/30 series can be operated with cooling air temperatures above 50°C by linearly de-rating the total maximum output power (or current) by 2.5%/°C from 50°C to 70°C (see figure 2).

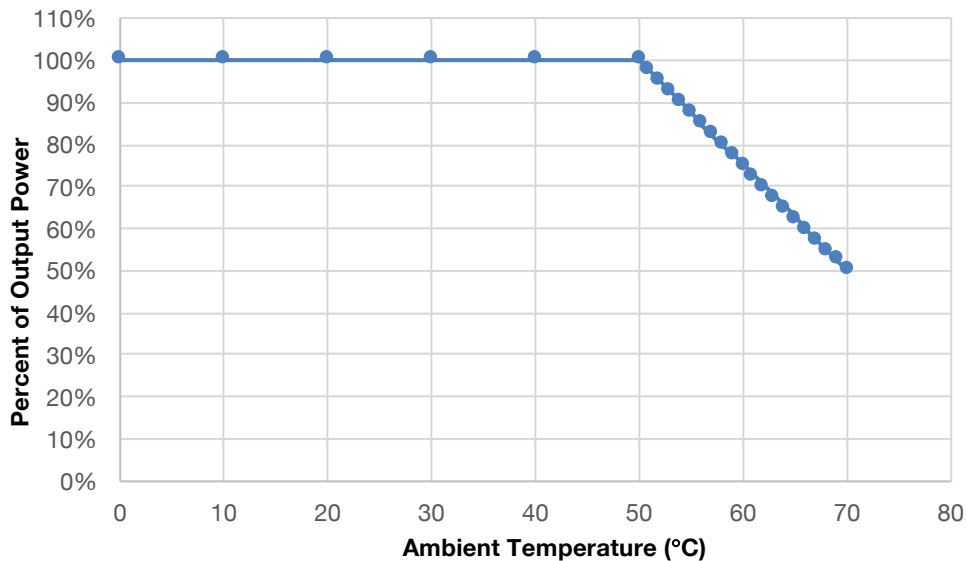

Figure 2

50, 40 & 30 W Programmable CC Class 2 / Class II LED Driver with Tri-Mode Dimming™ (TRIAC, ELV & 0-10 V)

9 - PHASE-CUT DIMMING

Dimming of the driver is possible with standard TRIAC-based incandescent dimmers that chop the AC voltage as shown in Figure 3, or with ELV dimmers. During the rapid rise time of the AC voltage when the dimmer turns on, the driver does not generate any voltage or current oscillations, and inrush current is controlled. During the on-time of the AC input, the driver regulates the output current based upon the conduction angle. The RMS value of the driver output current is proportional to the on-time of the AC input voltage. When operating with an incandescent dimmer, the RMS output current varies depending upon the conduction angle and RMS value of the applied AC input voltage. Figure 4 shows the typical output current versus conduction angle at nominal input voltage.

Forward-phase (TRIAC) and reverse-phase (ELV) dimming work only at 120 Vac. There is no TRIAC/ELV dimming for available PSBXXE models, only 0-10V dimming is available at 220, 230 & 240 Vac.

The PSB50/40/30 series offers Tri-Mode Dimming™ compatibility with both phase-cut (reverse-phase and forward-phase) and 0–10V dimmers. Phase-cut dimming always has priority over 0-10 V dimming.

Due to variances in the performance of TRIAC/ELV dimmers, PSB use with TRIAC/ELV dimming is recommended when a PSB driver is limited to being programmed from 80%-100% of maximum output current. If using a PSB driver with a TRIAC/ELV while programmed from 50%-79% of maximum output current, ERP recommends use of the PHB series driver.

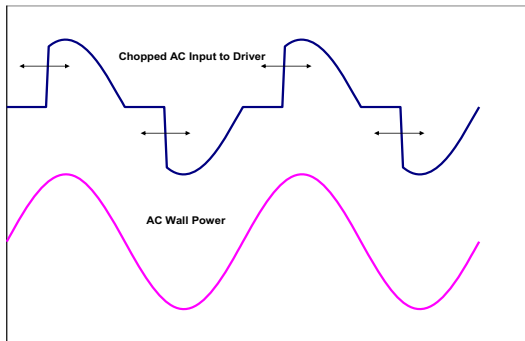

Figure 3

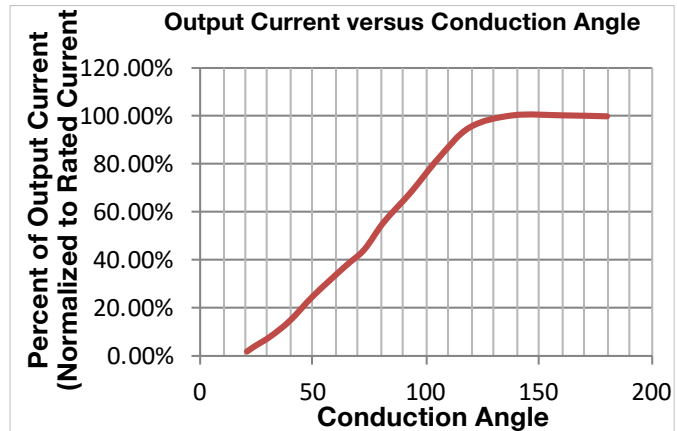

Figure 4

10 - COMPATIBLE PHASE-CUT DIMMERS & DIMMING RANGE

120Vac Dimmers					
Mfg.	Model	Mfg.	Model	Mfg.	Model
Lutron	S-603PG	Lutron	DVELV-303P	Lutron	CT-103P
Leviton	IPI06-1LZ	Lutron	SELV-300P	Cooper	SLC03P
Leviton	6631-2	Leviton	6683-IW	Leviton	IPE04
Lutron	DVCL-153P	Leviton	6161	Lutron	MAELV-600
Lutron	DV-600P	Leviton	6633-P	Lutron	FAELV-500
Lutron	TGCL-153P	Lutron	TG-600P	Lightolier	ZP260QEW
Lutron	S-600P	Cooper	DLC03P	Cooper	DAL06P
Leviton	VPE06	Lutron	LG-600P		

Dimming compatibility charts are available for each model in the PSB50/40/30 series. Please contact your sales representative or send an email to: SaveEnergy@erp-power.com.

50, 40 & 30 W Programmable CC Class 2 / Class II LED Driver with Tri-Mode Dimming™ (TRIAC, ELV & 0-10 V)

11 - 0-10 V DIMMING

The PSB50/40/30 series operate only with 0-10V dimmers that sink current. They are not designed to operate with 0-10V control systems that source current, as used in theatrical/entertainment systems. Developed in the 1980's, the 0-10V sinking current control method is adopted by the International Electrotechnical Commission (IEC) as part of its IEC Standard 60929 Annex E.

The method to dim the output current of the driver is done via the +Dim/-Dim Signal pins. The +Dim/-Dim Signal pins respond to a 0 to 10 V signal, delivering 1% to 100% of the output current based on rated current for each model. A pull-up resistor is included internal to the driver. When the +Dim wire (purple) is short circuited to the -Dim wire (grey) or to the -LED wire (blue), the output current turns off.

If the +Dim input is > 10 V or open circuited, the output current is programmed to 100% of the rated current.

When not used, the -Dim wire (grey) and to the +Dim wire (purple) can be individually capped or cut off. In this configuration, no dimming is possible and the driver delivers 100% of its rated output current.

The maximum source current (flowing from the driver to the 0-10V dimmer) supplied by the +Dim Signal pin is ≤ 1 mA. The tolerance of the output current while being dimmed shall be $\pm 8\%$ typical until down to 1.5 V.

In the PSB50/40/30 series, several 0-10V dimming profiles can be selected, such as a logarithmic profile, a non-linear profile with 1% minimum dimming and dim-to-off, and a non-linear profile with 10% minimum dimming and no dim-to-off. Furthermore, every point in the non-linear dimming profile can be programmed using the programming software.

By default, the non-linear profile with 1% minimum dimming and dim-to-off (show in figure 5) is pre-loaded in the PSB50/40/30 series. In this non-linear 0-10V dimming profile, 10V to 9.0V=100% of the output current, 1.5V to 0.7V=1%, <0.7V=dim-to-off (no output current).

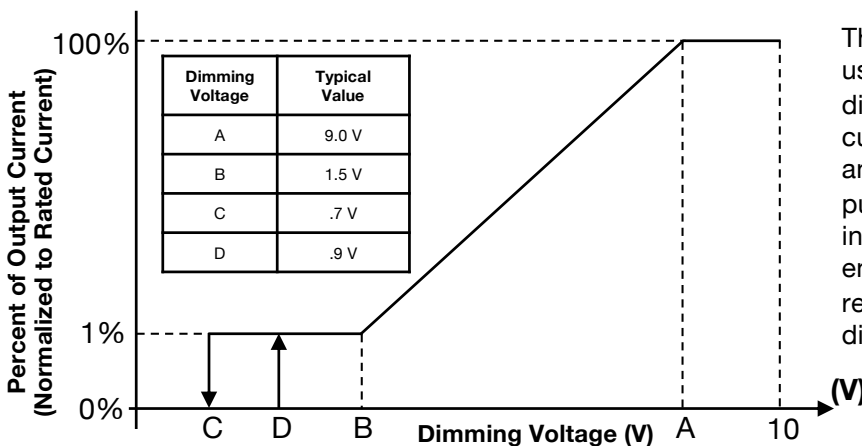

Figure 5

The non-linear curve is recommended when using standard in wall 0-10 V logarithmic dimmers to avoid having insufficient source current available to pull the dimmer up to 10V and to account for the inability of the dimmer to pull below approximately 0.9V. In these type of installations, the modified transfer function will ensure 100% light output and dimming to 1%, regardless of the number of drivers on the 0-10V dimming line.

12 - COMPATIBLE 0-10 V DIMMERS

- Lutron, Nova series (part number NFTV)
- Lutron, Diva series (part number DVTV)
- Leviton, IllumaTech series (part number IP710-DL)

50, 40 & 30 W Programmable CC Class 2 / Class II LED Driver with Tri-Mode Dimming™ (TRIAC, ELV & 0-10 V)

13 - PROGRAMMING

The PSB50/40/30 series can be programmed by inserting the audio jack of the cable shown in figure 6 into the driver and by plugging the USB other end of the cable into a computer. **The driver does not need to be powered on during the programming process.**

When ordering the PSB50/40/30 series, please make sure you order a programming cable. The part number for the programming cable is “PROG-JACK-USB”.

Programming is done by using the ERP GUI (Graphical User Interface), which enables the user to adjust output current from 100% to 50%.

Please note that, for each model, the **default output current setting is the minimum current.** For example, the default output current setting for the PSB50W-1200-42 is 600 mA.

Furthermore, when connecting the driver to a computer using the programming cable, you can access the driver’s internal data log and read the following information: SKU, serial number, manufacturing lot code, hours of operation, firmware revision, and fault events: power failure, transients (short or surge), thermal events (i.e. number of times the case temperature has exceed the maximum case temperature of 90° C).

While programming drivers in a lot, the ERP GUI can interface with a label printer, which enables the user to add configuration labels to driver labels in order to highlight programmed output current. Listed below is the equipment needed to print labels.

Equipment	Part Number	Where to buy
Printer	TSC TC210	https://www.barcodefactory.com/tsc/printers/tc210/99-059a001-54lf
Ribbon	TSC Prem. Resin, 60mm x 110mm	https://www.barcodefactory.com/tsc/35-r060110-23cf
Labels	BAR-.81x.28-1-TT	https://www.barcodefactory.com/barcodefactory/labels/bar-.81x.28-1-tt

For more information, please refer to the GUI user’s manual at:
<https://www.erp-power.com/our-products/programming-software/>



Figure 6

50, 40 & 30 W Programmable CC Class 2 / Class II LED Driver with Tri-Mode Dimming™ (TRIAC, ELV & 0-10 V)

14 - PREDICTED LIFETIME VERSUS CASE AND AMBIENT TEMPERATURE

Lifetime is defined by the measurement of the temperatures of all the electrolytic capacitors whose failure would affect light output under the nominal LED load and worst case AC line voltage. The graphs in figures 7 and 8 are determined by the electrolytic capacitor with the shortest lifetime, among all electrolytic capacitors. It represents a worst case scenario in which the LED driver is powered 24 hours/day, 7 days/week. The lifetime of an electrolytic capacitor is measured when any of the following changes in performance are observed:

- 1) Capacitance changes more than 20% of initial value
- 2) Dissipation Factor ($\tan \delta$): 150% or less of initial specified value
- 3) Equivalent Series Resistance (ESR): 150% or less of initial specified value
- 4) Leakage current: less of initial specified value

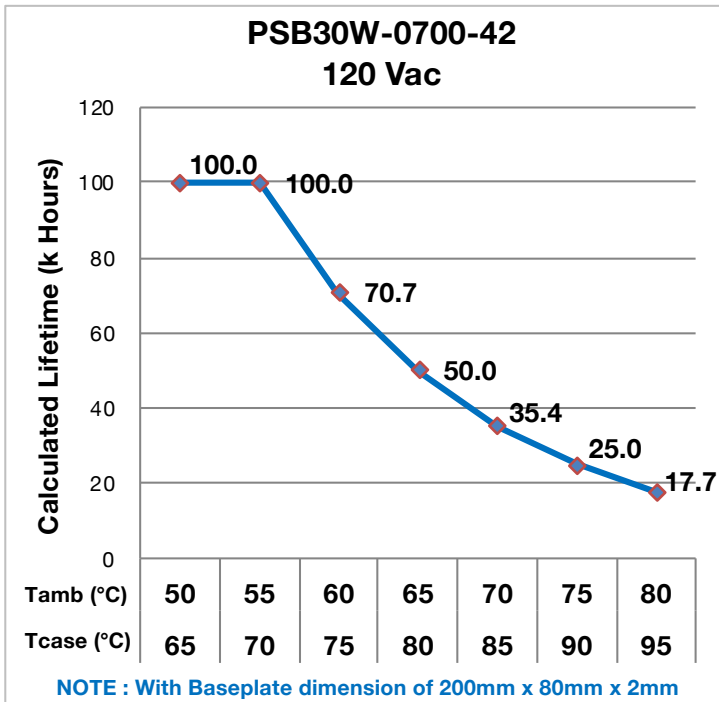

Figure 7

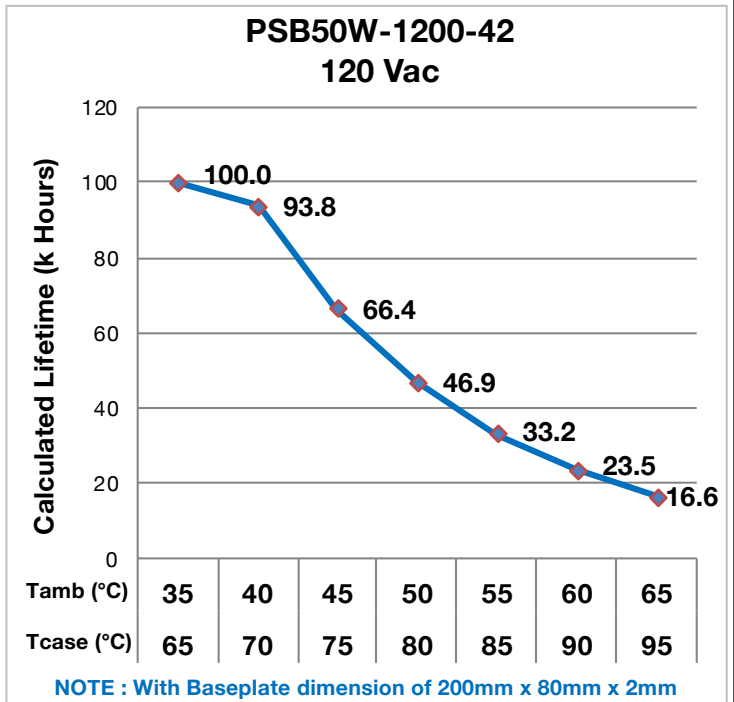

Figure 8

Notes:

- The ambient temperature $T_{ambient}$ and the differential between $T_{ambient}$ and T_{case} mentioned in the above graphs are relevant only as long as both the driver and the light fixture are exposed to the same ambient room temperature. If the LED driver is housed in an enclosure or covered by insulation material, then the ambient room temperature is no longer valid. In this situation, please refer only to the case temperature T_{case} .
- It should be noted the graph "Lifetime vs. Ambient Temperature" may have an error induced in the final application if the mounting has restricted convection flow around the case. For applications where this is evident, the actual case temperature measured at the Tc point in the application should be used for reliability calculations.

50, 40 & 30 W Programmable CC Class 2 / Class II LED Driver with Tri-Mode Dimming™ (TRIAC, ELV & 0-10 V)

15 – EFFICIENCY VERSUS LOAD

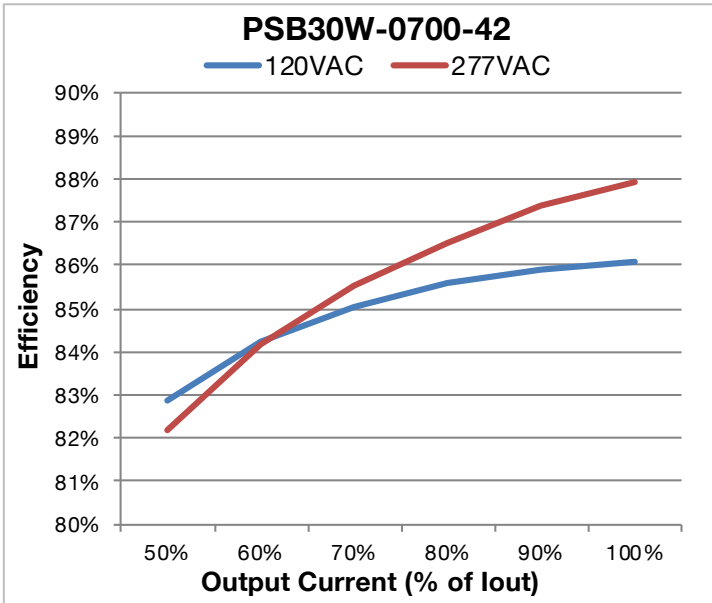

Figure 9

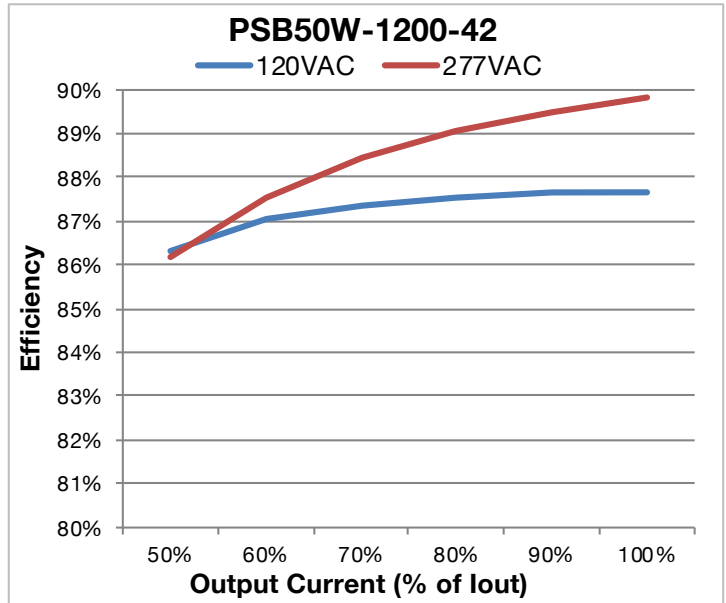

Figure 10

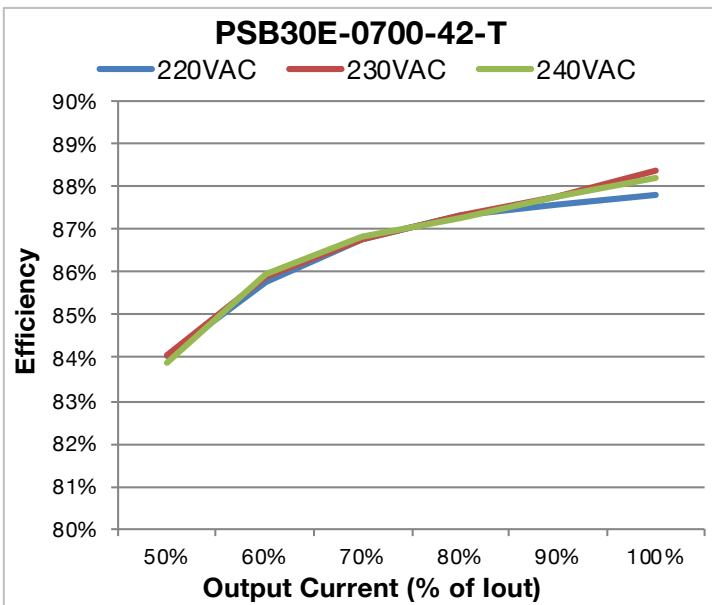

Figure 11

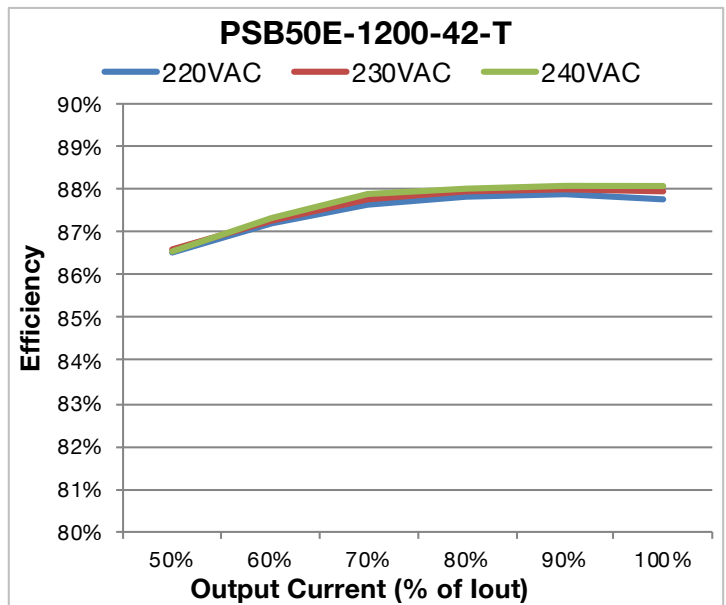

Figure 12

50, 40 & 30 W Programmable CC Class 2 / Class II LED Driver with Tri-Mode Dimming™ (TRIAC, ELV & 0-10 V)

16 – POWER FACTOR VERSUS LOAD

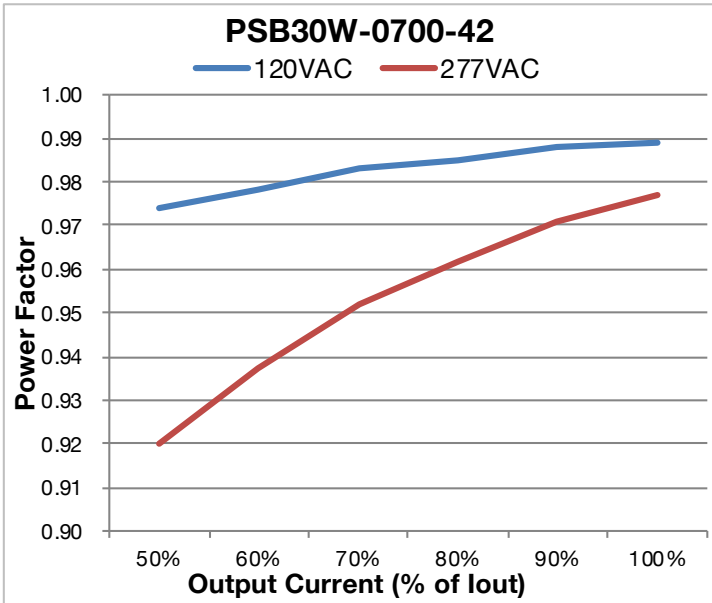

Figure 13

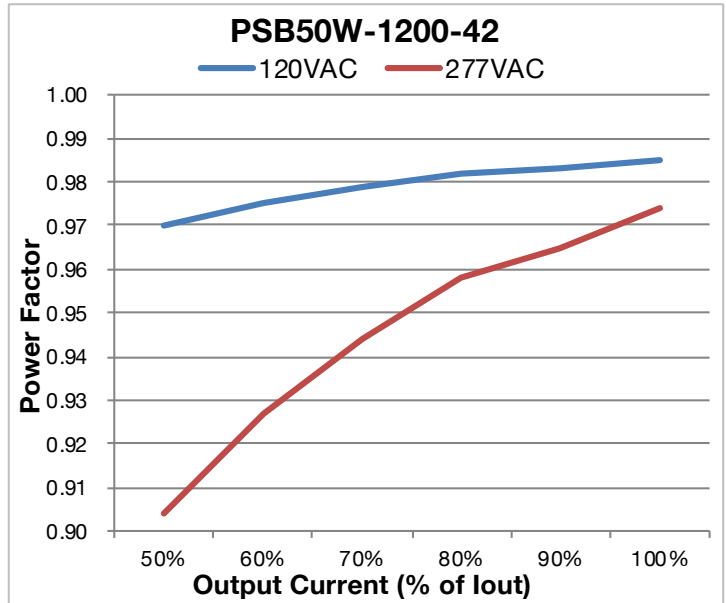

Figure 14

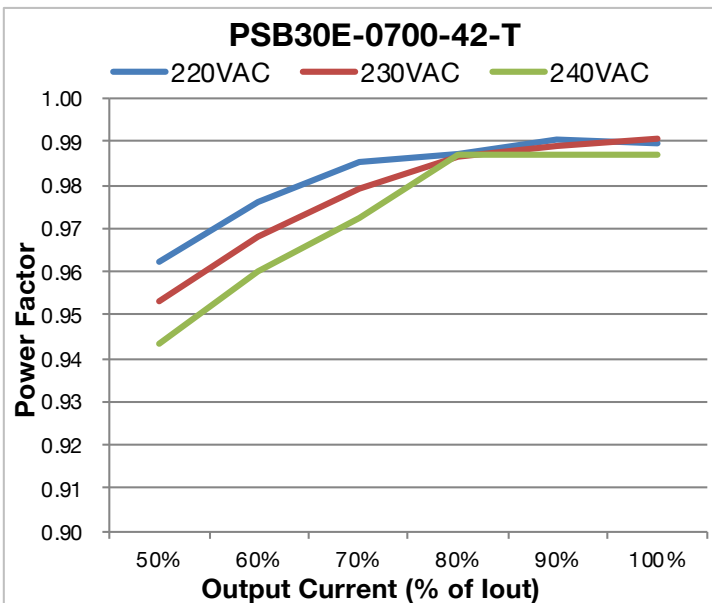

Figure 15

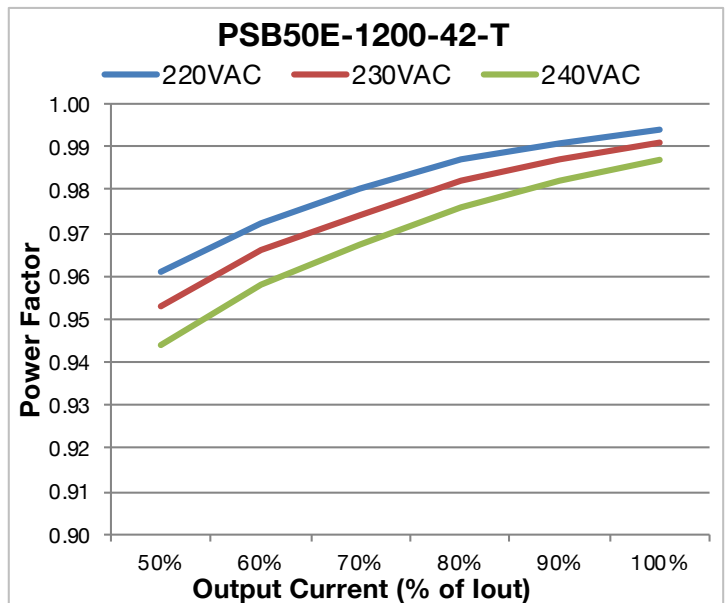

Figure 16

50, 40 & 30 W Programmable CC Class 2 / Class II LED Driver with Tri-Mode Dimming™ (TRIAC, ELV & 0-10 V)

17 - THD VERSUS LOAD

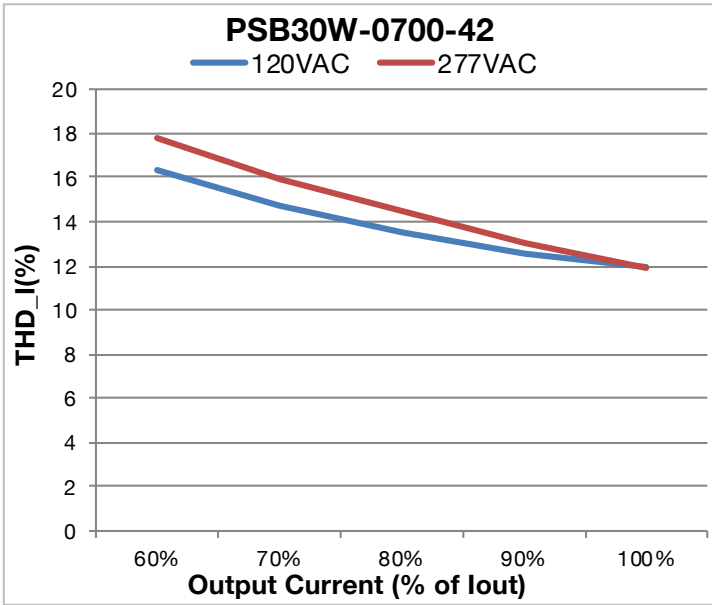

Figure 17

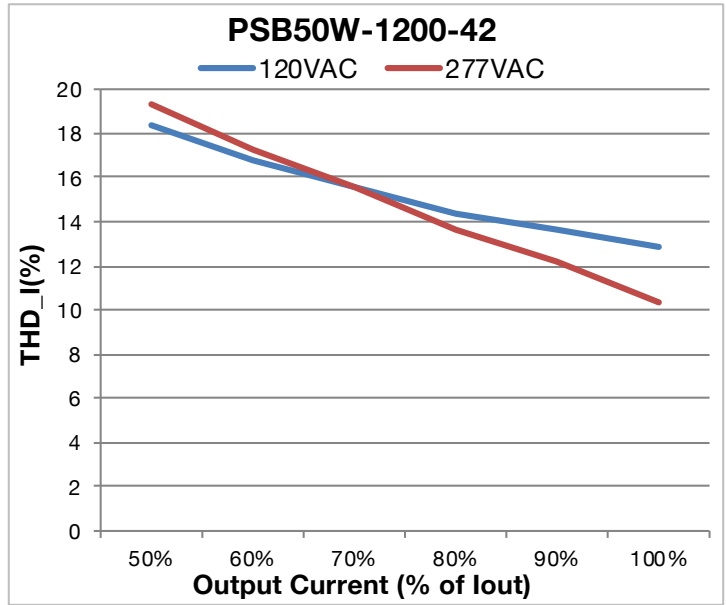

Figure 18

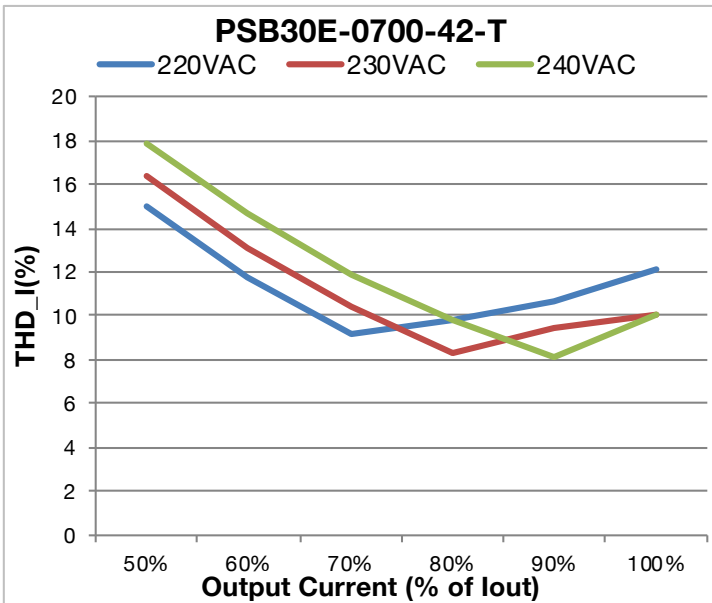

Figure 19

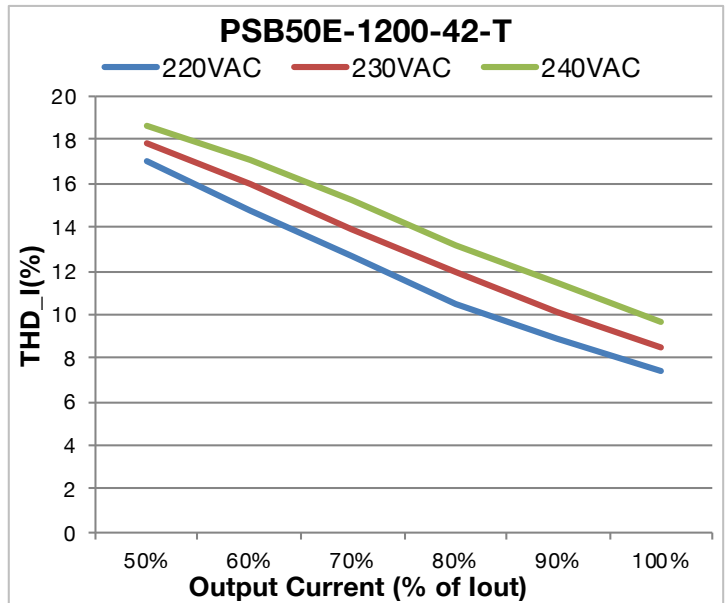

Figure 20

50, 40 & 30 W Programmable CC Class 2 / Class II LED Driver with Tri-Mode Dimming™ (TRIAC, ELV & 0-10 V)

18 - MECHANICAL DETAILS

- **Packaging:** Aluminum case
- **I/O Connections:**
 - **Models with flying leads:** 18 AWG on all leads, 22 AWG on 0-10V dimming wires, 203mm (8 in) long, 105°C rated, stranded, stripped by approximately 9.5 mm, and tinned. All the wires, on both input and output, have a 300 V insulation rating.
 - **Models with “T” suffix:** Terminal Blocks
 - **Models with “S” suffix:** Bottom Leads with Studs
- **Ingress Protection:** IP20 rated
- **Mounting Instructions:** The PSB50/40/30 driver case must be secured on a flat surface through the two mounting tabs, shown here below in the case outline drawings.

19 - OUTLINE DRAWINGS (PSBXXW MODELS WITH FLYING LEADS)

Dimensions: L 98.5 x W 26.0 x H 21.85 mm (L 3.88 x W 1.02 x H 0.86 in.)

Volume: 55.96 cm³ (3.41 in³)

Weight: 113 g (3.99 oz)

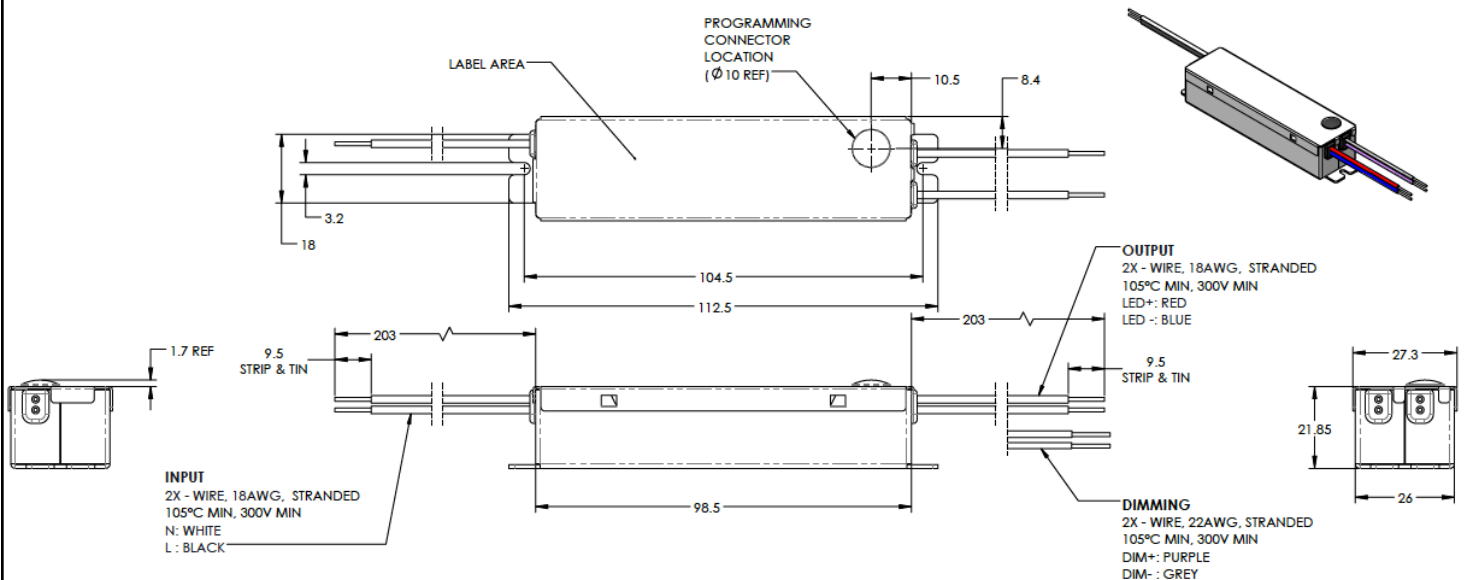

All dimensions are in mm

Figure 21

50, 40 & 30 W Programmable CC Class 2 / Class II LED Driver with Tri-Mode Dimming™ (TRIAC, ELV & 0-10 V)

20 - OUTLINE DRAWINGS (PSBXXE MODELS WITH FLYING LEADS)

Dimensions: L 107.7 x W 26.0 x H 21.85 mm (L 4.24 x W 1.02 x H 0.86 in)
Weight: 114 g (4.02 oz)

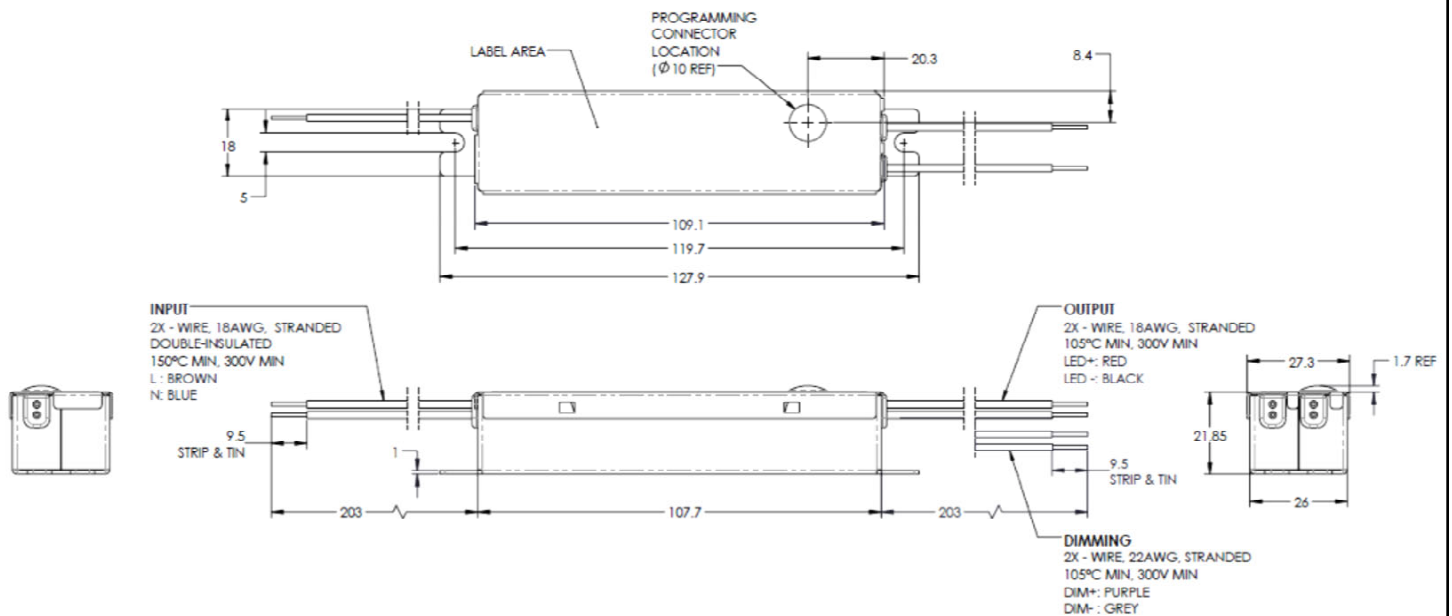

All dimensions are in mm

Figure 22

50, 40 & 30 W Programmable CC Class 2 / Class II LED Driver with Tri-Mode Dimming™ (TRIAC, ELV & 0-10 V)

21 - OUTLINE DRAWINGS (MODELS WITH "-T" SUFFIX)

Dimensions: L 158 x W 26.2 x H 21.85 mm (L 6.22 x W 1.03 x H 0.86 in)

Weight: 115 g (4.06 oz)

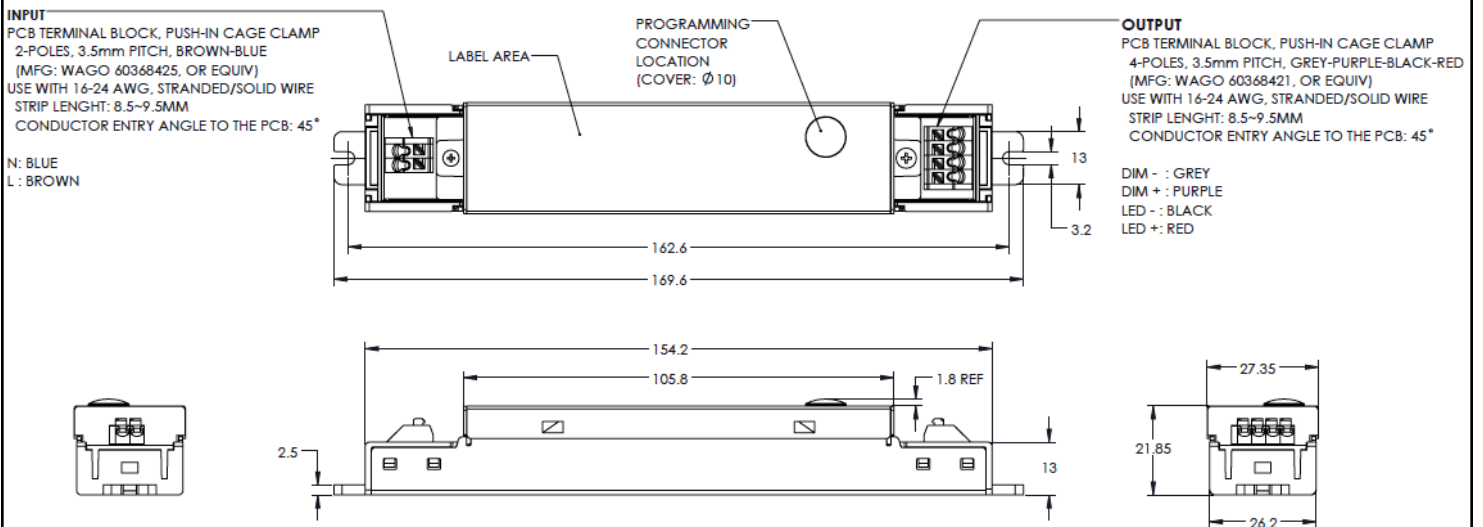

All dimensions are in mm

Figure 23

50, 40 & 30 W Programmable CC Class 2 / Class II LED Driver with Tri-Mode Dimming™ (TRIAC, ELV & 0-10 V)

22 - OUTLINE DRAWINGS (MODELS WITH “-T” SUFFIX AND STRAIN RELIEFS)

Dimensions: L 212.6 x W 26.2 x H 19.85 mm (L 8.37 x W 1.03 x H 0.78 in)

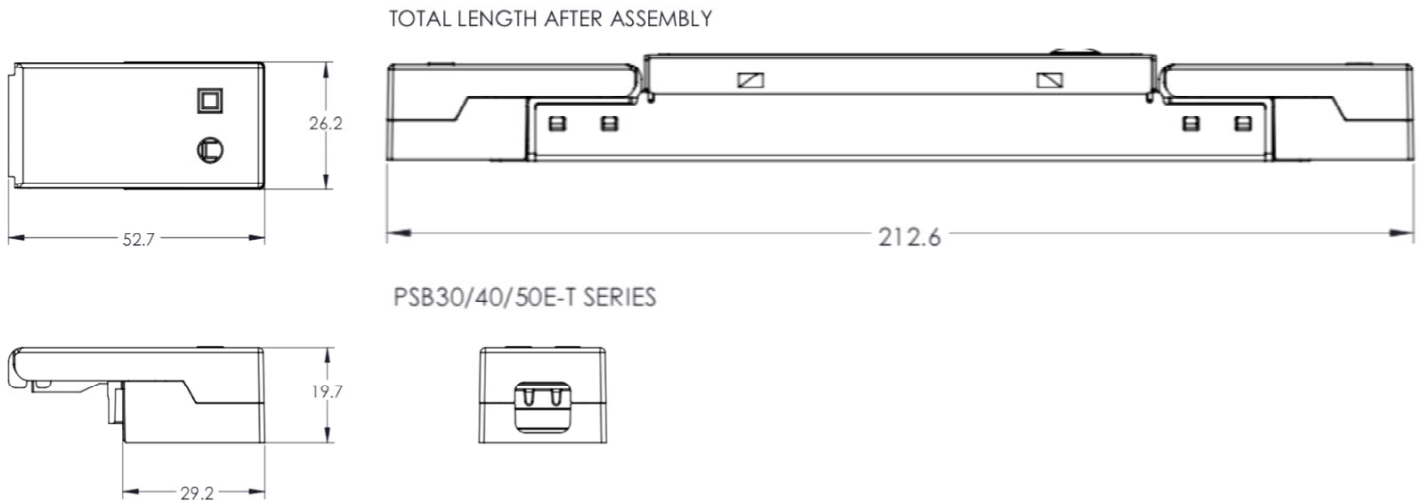

Strain reliefs for “-T” models can be ordered using part number SR2. Additional information regarding strain reliefs can be found under the accessories section on the ERP website.

All dimensions are in mm

Figure 24

50, 40 & 30 W Programmable CC Class 2 / Class II LED Driver with Tri-Mode Dimming™ (TRIAC, ELV & 0-10 V)

23 - OUTLINE DRAWINGS (MODELS WITH "-S" SUFFIX)

Dimensions: L 98.5 x W 26.0 x H 23.7 mm (L 3.88 x W 1.02 x H 0.93 in)

Weight: 116 g (4.09 oz)

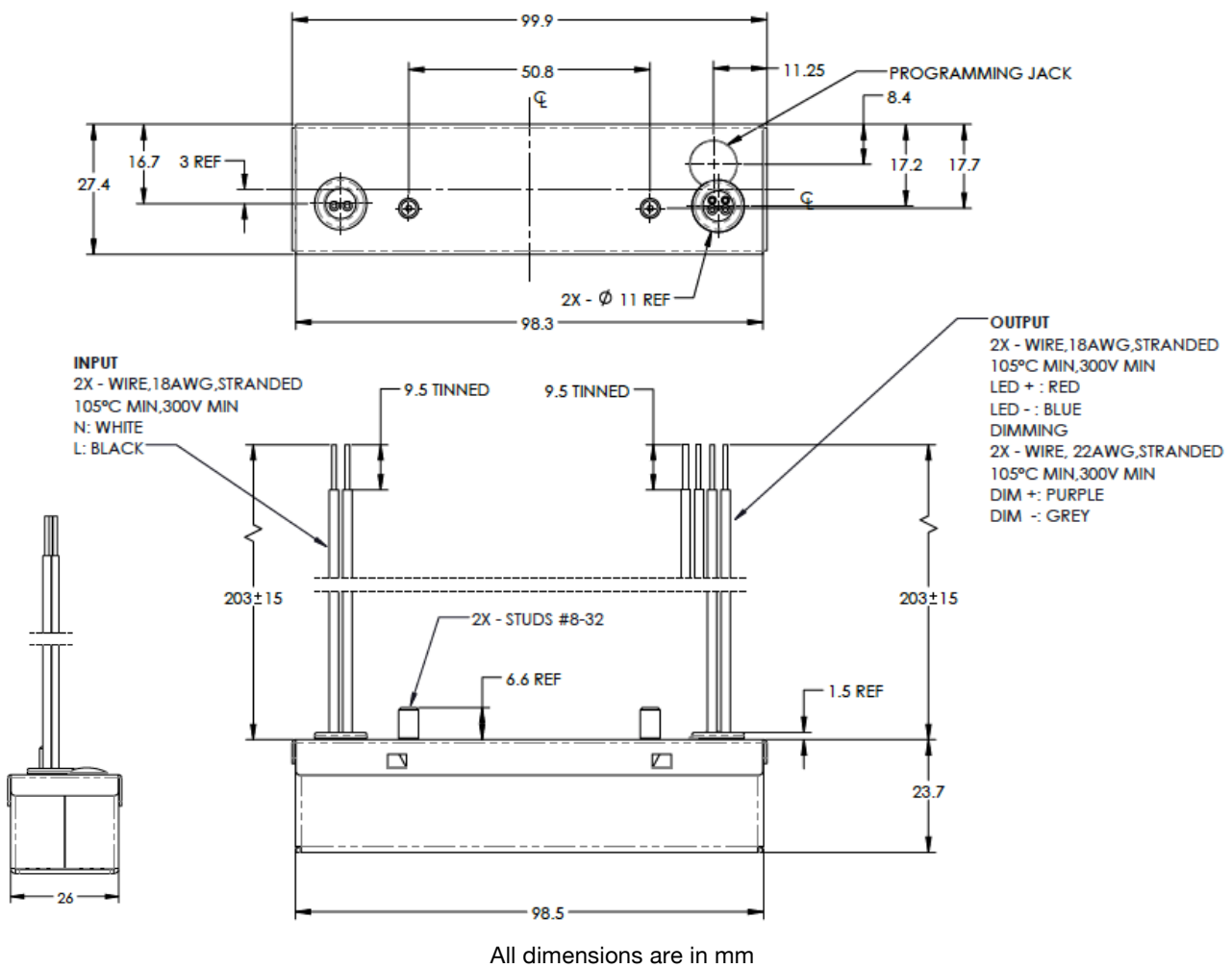

Figure 25

50, 40 & 30 W Programmable CC Class 2 / Class II LED Driver with Tri-Mode Dimming™ (TRIAC, ELV & 0-10 V)

24 - LABELING

The PSB50W-1200-42 and PSB50E-1200-42-T are used respectively in figure 26 and figure 27 as an example to illustrate a typical label.

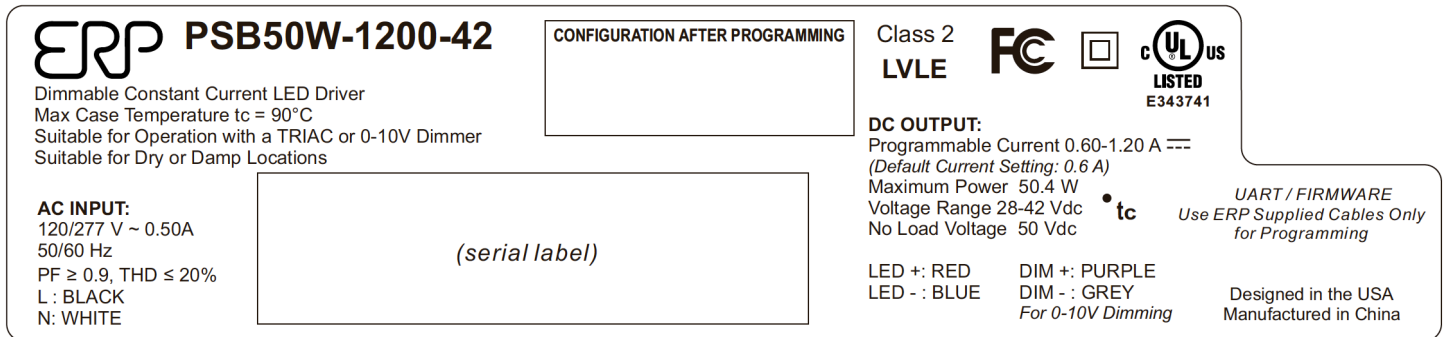

Figure 26

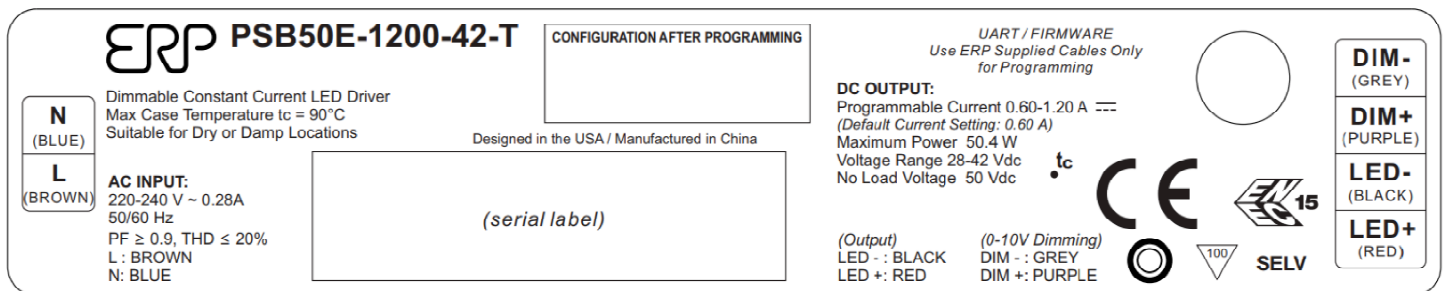

Figure 27

USA Headquarters
 Tel: +1-805-517-1300
 Fax: +1-805-517-1411
 893 Patriot Drive, Suite E,
 Moorpark, CA 93021, USA

CHINA Operations
 Tel: +86-756-6266298
 Fax: +86-756-6266299
 No. 8 Pingdong Road 2
 Zhuhai, Guangdong, China 519060

ERP Power, LLC (ERP) reserves the right to make changes without further notice to any products herein. ERP makes no warranty, representation or guarantee regarding the suitability of its products for any particular purpose, nor does ERP assume any liability arising out of the application or use of any product or circuit, and specifically disclaims any and all liability, including without limitation special, consequential or incidental damages. "Typical" parameters which may be provided in ERP data sheets and/or specifications can and do vary in different applications and actual performance may vary over time. All operating parameters, including "Typicals" must be validated for each customer application by customer's technical experts. ERP does not convey any license under its patent rights nor the rights of others. ERP products are not designed, intended, or authorized for use as components in systems intended for surgical implant into the body, or other applications intended to support or sustain life, or for any other application in which the failure of the ERP product could create a situation where personal injury or death may occur. Should Buyer purchase or use ERP products for any such unintended or unauthorized application, Buyer shall indemnify and hold ERP and its officers, employees, subsidiaries, affiliates, and distributors harmless against all claims, costs, damages, and expenses, and reasonable attorney fees arising out of, directly or indirectly, any claim of personal injury or death associated with such unintended or unauthorized use, even if such claim alleges that ERP was negligent regarding the design or manufacture of the part. ERP is an Equal Opportunity/Affirmative Action Employer. This literature is subject to all applicable copyright laws and is not for resale in any manner.



PSB50/40/30 Series

PSB50 50 W
PSB40 40 W
PSB30 30 W

50, 40 & 30 W Programmable CC Class 2 / Class II LED Driver with Tri-Mode Dimming™ (TRIAC, ELV & 0-10 V)

Revision History

Date	Comments
01MAY2018	<ul style="list-style-type: none"> Added part numbers for the case with bottom leads and studs Changed the PSB30W-0800-34 to PSB30W-0700-34
11OCT2018	<ul style="list-style-type: none"> Changed AC line voltage from "120/277 Vac" to "120 & 277 Vac" Master: changed title from "Constant Current" to "CC Class 2 / Class II" Pg1: added SELV Class 2 to safety marks Pg2: changed table to include units Pg5: updated hi pot to 2500/4242 Pg9: changed 3rd paragraph grammar Added note that 0-10V dimming is only dimming available at 220, 230 & 240 Vac
12DEC2018	<ul style="list-style-type: none"> Pg2: added PSBX0E-XXXX-XX models Pg4,8: changed dim to off voltages: .7, 9.0 Pg3,5: changed suffix stuff to PSBXXW models and PSBXXE models Added strain relief Mechanical Case Outline (MCO)
28JAN19	<ul style="list-style-type: none"> Pg1: changed 9.1 to 9.0V, .55V to .7V changed "-T" to PSBXXE models in regards to no TRIAC dimming Pg4: added minimum dimming tolerance Pg7: changed "-T" to PSBXXE Pg9: added printer info
13FEB19	<ul style="list-style-type: none"> Pg1: changed render files to stamped metal Pg10-13: changed MCO to stamped metal case Added lifetime page Added characterization curves
20MAR2019	<ul style="list-style-type: none"> Pg2: added strain relief part number Pg16: added strain relief part number
09APR2019	<ul style="list-style-type: none"> Added Euro flying leads MCO Added weights
19JUN2019	<ul style="list-style-type: none"> Pg3: added 80-100% rule to TRIAC/ELV dimming Pg7: added 80-100% rule to TRIAC/ELV dimming Pg17: added referral to strain relief datasheet