

LUXEON Atilon

*Automotive Forward
Lighting Source*

Technical Datasheet DS66

LUXEON
NEVER BEFORE POSSIBLE



AEC-Q101
Qualified

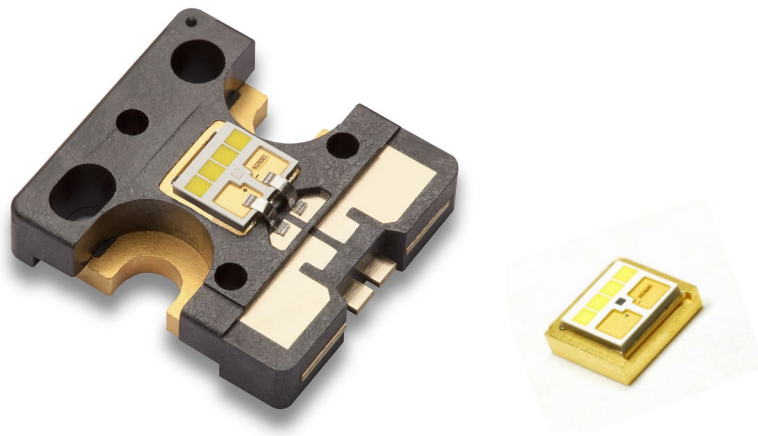

LUXEON[®] Atilon

Automotive Forward Lighting Source

Introduction

LUXEON[®] Atilon LEDs are specifically designed and tested to meet and exceed expectations for reliability, performance, and lifetime in automotive forward lighting applications. With advanced technologies, LUXEON Atilon meets both SAE and ECE color specifications and provides finer granularity than existing systems. PPAP documentation is available upon request. LUXEON Atilon LEDs provide significant flexibility and are superior LED products for:

- High Beam/Low Beam
- Daytime Running Lights (DRL)
- Static Bending Lights
- Position Lamps
- AFS Functionality

PHILIPS
LUMILEDS

Table of Contents

Product Information.....	3
Part Number Description.....	3
Test Conditions for Optical Characteristics	3
Environmental Compliance.....	3
Optical Characteristics.....	4
Measured and Typical Optical Performance by Part Number.....	4
Typical Luminance Performance	5
Typical Use Condition Matrix—Relative Flux	5
Typical Relative Luminous Flux vs. Forward Current	6
Typical Relative Luminous Flux vs. Case Temperature	6
Electrical Characteristics.....	7
Typical Electrical Characteristics at Temperature Extremes	8
Typical DC Forward Current vs. Forward Voltage	9
Absolute Maximum Ratings	10
Reliability Expectations and Thermal Design Requirements	11
Mechanical Dimensions	12
Color Bin Definitions.....	14
Laser Marking Definitions	15
Flux Bin Definitions	16
Typical Spectrum	17
Typical Color vs. Angle.....	17
Color Shift vs. Case Temperature.....	18
Color Shift vs. DC Drive Current.....	19
Typical Radiation Pattern.....	20
Packing Information	21
Product Labeling Information.....	24

Product Information

Part Number Description

LUXEON Altilon LEDs are tested and binned at 1000 mA, with current pulse duration of 20ms.

LUXEON Altilon

L	A	F	L	-	C	2	S	-	X	X	X	X
Standard Prefix for LUXEON Altilon					Default	Number of Chips - 2 or 4	Solder or Spade Lugs - S or L		Minimum Flux Bin			

LUXEON Altilon Core

L	A	C	L	-	C	2	S	-	X	X	X	X
Standard Prefix for LUXEON Altilon Core					Default	Number of Chips - 2 or 4	Solder Configuration		Minimum Flux Bin			

Test Conditions for Optical Characteristics Junction Temperature vs. Case Temperature

Philips Lumileds specifies performance at constant case temperature for LUXEON Altilon. This datasheet specifies performance at constant case temperature of 25°C, except where noted. The data sheet that follows will specify performance at constant case temperature of 25°C.

Case temperature refers to the temperature of a thermocouple mounted under the head of one of the mounting screws, and is a value that can be measured rather than calculated (see Figure 7). A junction-to-case thermal resistance of 2.1°C/W is assumed for the 1x2 configuration and 1.4°C/W for the 1x4 configuration. This approach will more accurately capture product performance capabilities compared to average junction temperature alone.



Environmental Compliance

Philips Lumileds is committed to providing environmentally friendly products to the lighting industry. LUXEON Altilon is compliant to the European Union directives on the restriction of hazardous substances in electronic equipment, namely, the RoHS, ELV, and REACH directives. Philips Lumileds will not intentionally add the following restricted materials to the LUXEON Altilon product: lead, mercury, cadmium, hexavalent chromium, polybrominated biphenyls (PBB), or polybrominated diphenyl ethers (PBDE).

Optical Characteristics

Measured and Typical Optical Performance by Part Number

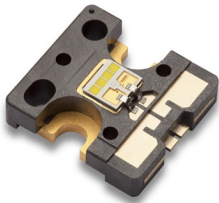
Table I.

	Part Number	Form Factor	Measured Test Condition 1000 mA Pulsed Operation (20 msec) Case Temperature $T_c = 25^\circ\text{C}$ Minimum Luminous Flux (lm) ^[1,2]
 <p>LUXEON Altilon</p>	LAFL - C2* - 0350	1x2	350
	LAFL - C2* - 0425	1x2	425
	LAFL - C2* - 0500	1x2	500
	LAFL - C4* - 0700	1x4	700
	LAFL - C4* - 0850	1x4	850
	LAFL - C4* - 0925	1x4	925
	LAFL - C4* - 1000	1x4	1000
	LAFL - C4* - 1050	1x4	1050
 <p>LUXEON Altilon Core</p>	LACL - C2S - 0350	1x2	350
	LACL - C2S - 0425	1x2	425
	LACL - C2S - 0500	1x2	500
	LACL - C4S - 0700	1x4	700
	LACL - C4S - 0850	1x4	850
	LACL - C4S - 0925	1x4	925
	LACL - C4S - 1000	1x4	1000
	LACL - C4S - 1050	1x4	1050

Notes for Table I:

1. Philips Lumileds tests flux values via a pulsed measurement at a case temperature of 25°C.
2. Minimum luminous flux guaranteed within published operating conditions. Philips Lumileds maintains a tolerance of $\pm 10\%$ on flux measurements.
3. "*" Indicates the inclusion or exclusion of the spade lug connector, indicated with an 'L' for spade lug, and an 'S' for those parts without. See Part Number Description below for more details.

Typical Luminance Performance

Typical luminance is calculated based on the total lumens emitted from the smallest rectangle covering the optical source. This method accounts for variations in chip and phosphor placement as well as spacing between discrete chips. Figure 1 below indicates the orientation used to determine the source area used for luminance calculations.

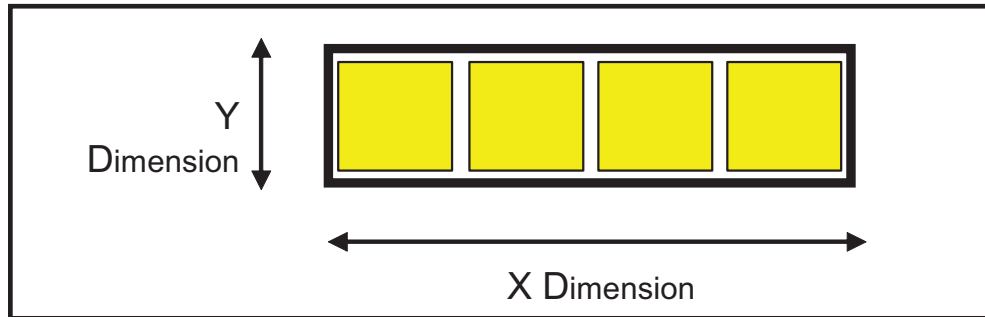

Figure 1. Area surrounding optical source for luminance measurements.

For the 1x4 configuration, the typical X and Y dimensions are 4.51 and 1.06 mm, respectively.

For the 1x2 configuration, the typical X and Y dimensions are 2.21 and 1.06 mm, respectively.

Typical Use Condition Matrix—Relative Flux

Normalized to $T_c = 25^\circ\text{C}$, 1000 mA, 20 msec pulses

The graphs on the next page predict the relative flux under various use conditions normalized to the test conditions of 1000 mA pulsed operation (20 msec pulse) at case temperature of 25°C . These graphs can be used to determine the effects of case temperature and forward current on the values of minimum and typical flux to define performance at the expected use condition. For example:

Given a flux at $T_c = 25^\circ\text{C}$ and 1000 mA (20 msec pulse) of 700 lm for 1x4 configuration, the flux value under different conditions can be predicted.

If expected use condition is 700 mA at $T_c = 100^\circ\text{C}$, the relative percentage of flux would be approximately 70% of the reference value.

Hence, the predicted flux at 700 mA and $T_c = 100^\circ\text{C}$: $700 \text{ lm} \times 0.7 = 490 \text{ lm}$.

Typical Relative Luminous Flux vs. Forward Current

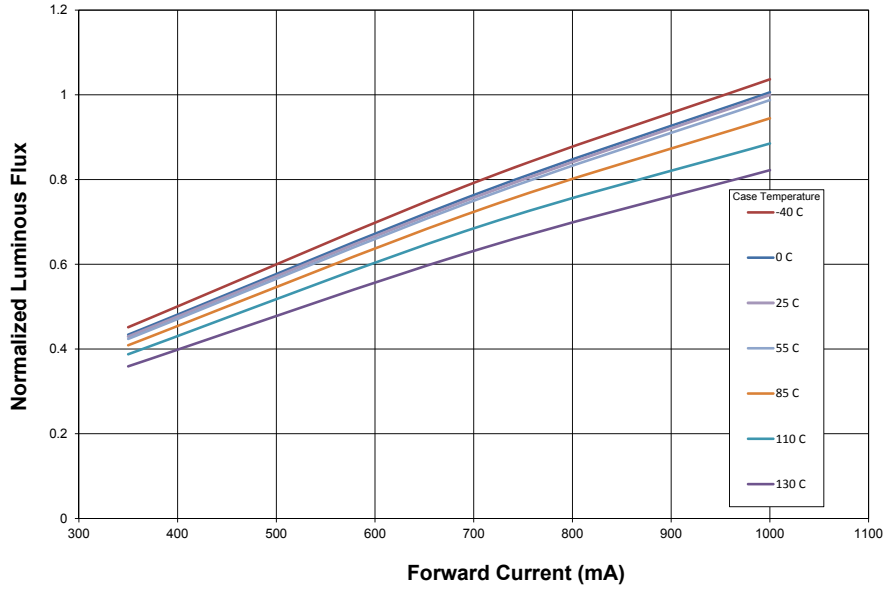

Figure 2. Typical relative luminous flux vs. forward current.

Typical Relative Luminous Flux vs. Case Temperature

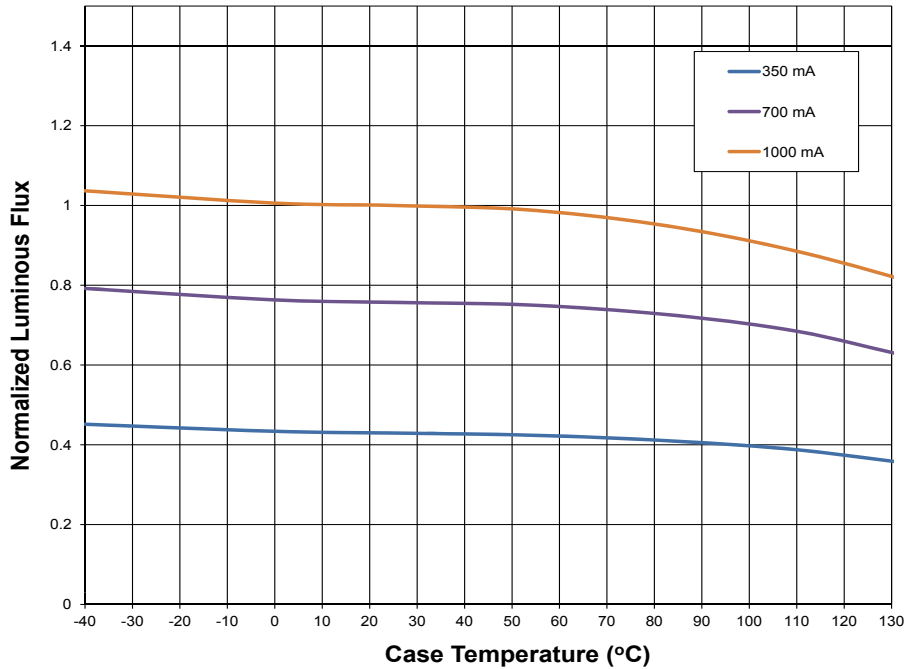

Figure 3. Typical relative luminous flux vs. case temperature.

Electrical Characteristics

Table 2.

Form Factor	Test Condition			Dynamic Resistance ^[3] (Ω) R_D
	1000 mA Pulsed Operation			
	Case Temperature $T_c = 25^\circ\text{C}$			
	Forward Voltage V_f ^[1,2] (V)			
	Min.	Typical	Max.	
1x2	5.6	6.4	7.5	1.2
1x4	11.2	12.7	15.0	1.8

Notes for Table 2:

1. Philips Lumileds tests forward voltage values via a pulsed measurement at junction temperature of 25°C .
2. Philips Lumileds maintains a tolerance of $\pm 0.06\text{V}$ on forward voltage measurements.
3. Dynamic resistance is the inverse of the slope in linear forward voltage model for LEDs.

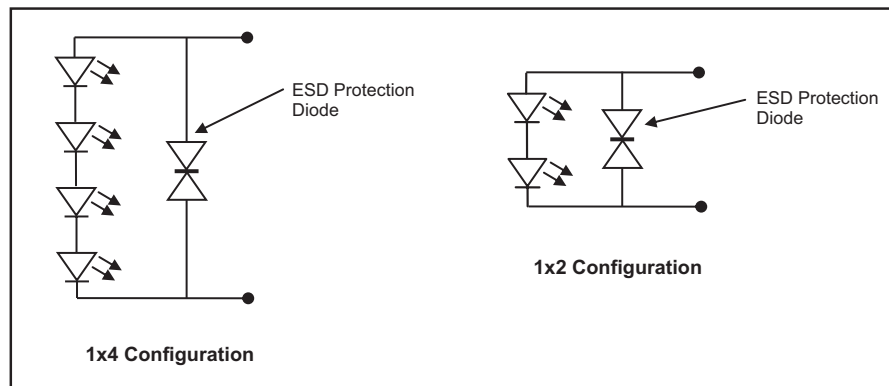

Figure 4. Electrical schematic of forward lighting sources.

Typical Electrical Characteristics at Temperature Extremes

Table 3.

Form Factor	Typical Condition 1000 mA DC Operation Case Temperature $T_c = -40^\circ\text{C}$ Forward Voltage V_f ^[1] (V)			Typical Condition 1000 mA DC Operation Case Temperature $T_c = 130^\circ\text{C}$ Forward Voltage V_f ^[1] (V)		
	Min.	Typical	Max.	Min.	Typical	Max.
	1x2	5.6	6.8	7.9	5.0	5.9
1x4	11.2	13.2	15.8	10.0	11.8	14.5

Notes for Table 3:

- Philips Lumileds tests forward voltage values via a pulsed measurement at junction temperature of 25°C . Typical product performance at maximum and minimum allowable case temperature to allow for electronic driver design. Values provided are guard banded to ensure that minimum and maximum values are not exceeded under stated use conditions.

Typical DC Forward Current vs. Forward Voltage

The graphs below predict the change in forward voltage compared to the value at case temperature of 25°C at 1000 mA under various use conditions. These graphs can be used to determine the effects of case temperature and forward current on the values of minimum, typical and maximum forward voltage to define performance at the expected use condition.

Typical DC Forward Current vs. Forward Voltage 1x4 Configuration

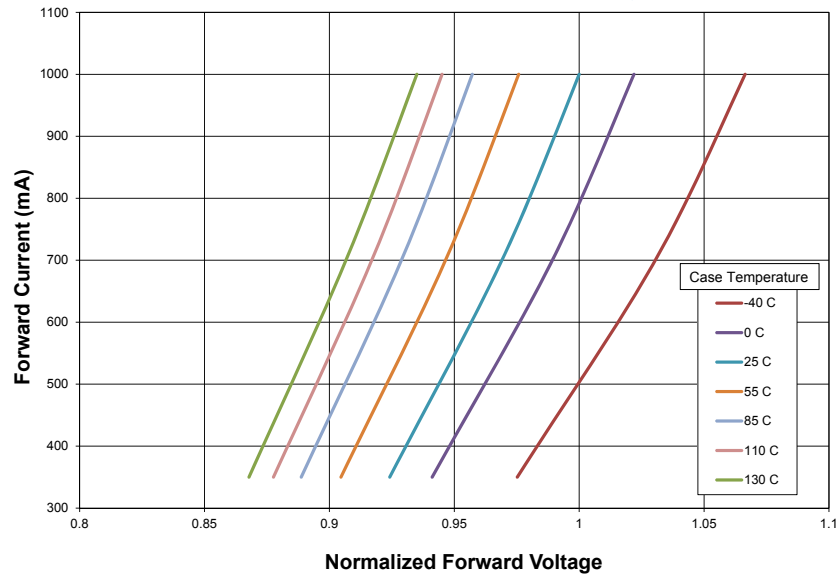

Figure 5. Typical forward current vs. forward voltage for 1x4 configuration.

Typical DC Forward Current vs. Forward Voltage 1x2 Configuration

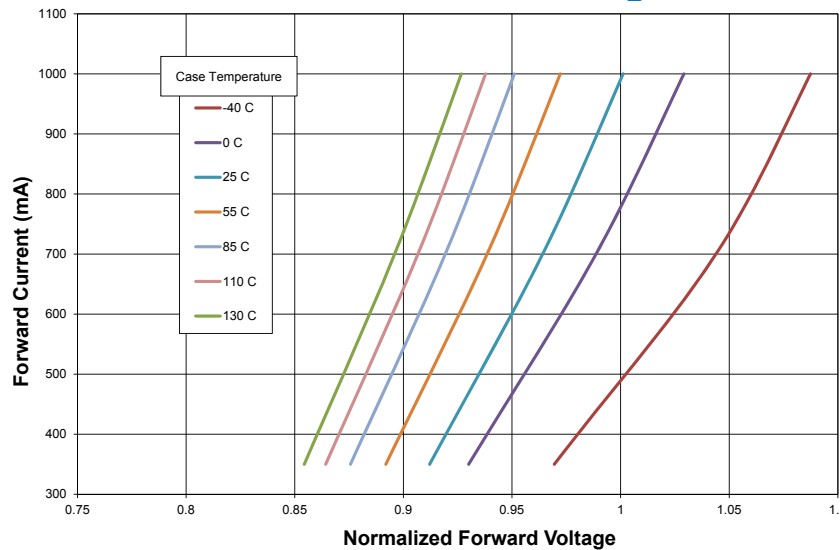

Figure 6. Typical forward current vs. forward voltage for 1x2 configuration.

Notes for Figures 5 and 6:

1. All values compared to reference value at case temperature of 25°C and 1000 mA DC forward current.

Absolute Maximum Ratings

Table 4.

Parameter	Value
Maximum DC Forward Current (mA) ^[1]	1 100
Minimum DC Forward Current (mA) ^[1]	100
Maximum Transient Peak Current	1500 mA for ≤ 10 ms
Maximum Vf at 1000 mA & -40°C ^[2]	15.8 Volts (1x4) 7.9 Volts (1x2)
Minimum Vf at 1000 mA & 130°C ^[3]	10.0 Volts (1x4) 5.0 Volts (1x2)
Maximum AC Ripple	≤ 50 mA rms at ≥ 10 kHz
ESD Sensitivity ^[4]	8kV HBM, 2kV CDM, 400V MM
Storage Temperature	-40°C to +130°C
Minimum Operating Case Temperature	-40°C
Maximum Case Temperature (1000 mA) ^[5]	130°C
Maximum Allowed Solder Pad Temperature	270°C, max. 30 sec.

Notes for Table 4:

1. Although no damage to the device will occur, driving these high power LEDs at drive currents below 350 mA or above 1000 mA may result in unpredictable performance. Please consult your Philips Lumileds sales representative for further information.
2. Product Vf at 1000 mA operation, case temperature -40°C after 1000 hours of operation at rated conditions.
3. Product Vf at 1000 mA operation, case temperature 130°C after 1000 hours of operation at rated conditions.
4. Measured using human body model, contact discharge method, and machine model (per AEC-Q101C).
5. Maximum case temperature for short term operation only. See section on reliability expectation and thermal design requirements for recommendations on maximum case temperature to ensure life of vehicle performance.
6. LEDs are not designed to be driven in reverse bias.

JEDEC Moisture Sensitivity

Table 6.

Level	Time	Floor Life	Conditions
I	unlimited		$\leq 30^\circ\text{C} / 85\% \text{ RH}$

Reliability Expectations and Thermal Design Requirements

Table 6.

Operating Condition	B50L80	B3L80
1000 mA, $T_c = 130^\circ\text{C}$	15000hrs	5000
1000 mA, $T_c = 110^\circ\text{C}$	40000	15000
700 mA, $T_c = 110^\circ\text{C}$	75000	25000
500 mA, $T_c = 110^\circ\text{C}$	120000	35000

Notes for Table 6:

1. As measured at the position indicated in Figure 7.
2. Lumen maintenance is a projected average value based on constant current operation while respecting the specified maximum case temperature. Observation of design limits included in this data sheet is required in order to achieve this projected Lumen Maintenance.
3. Lifetime shown is an estimation of expected lifetimes (B_{xx} , L_{yy}) computed as 90% lower confidence limit of the LUXEON Altilon product as a function of drive current and case temperature. The lifetime estimates in the above table reflect statistical figures based on calculations of technical data and are subject to change.

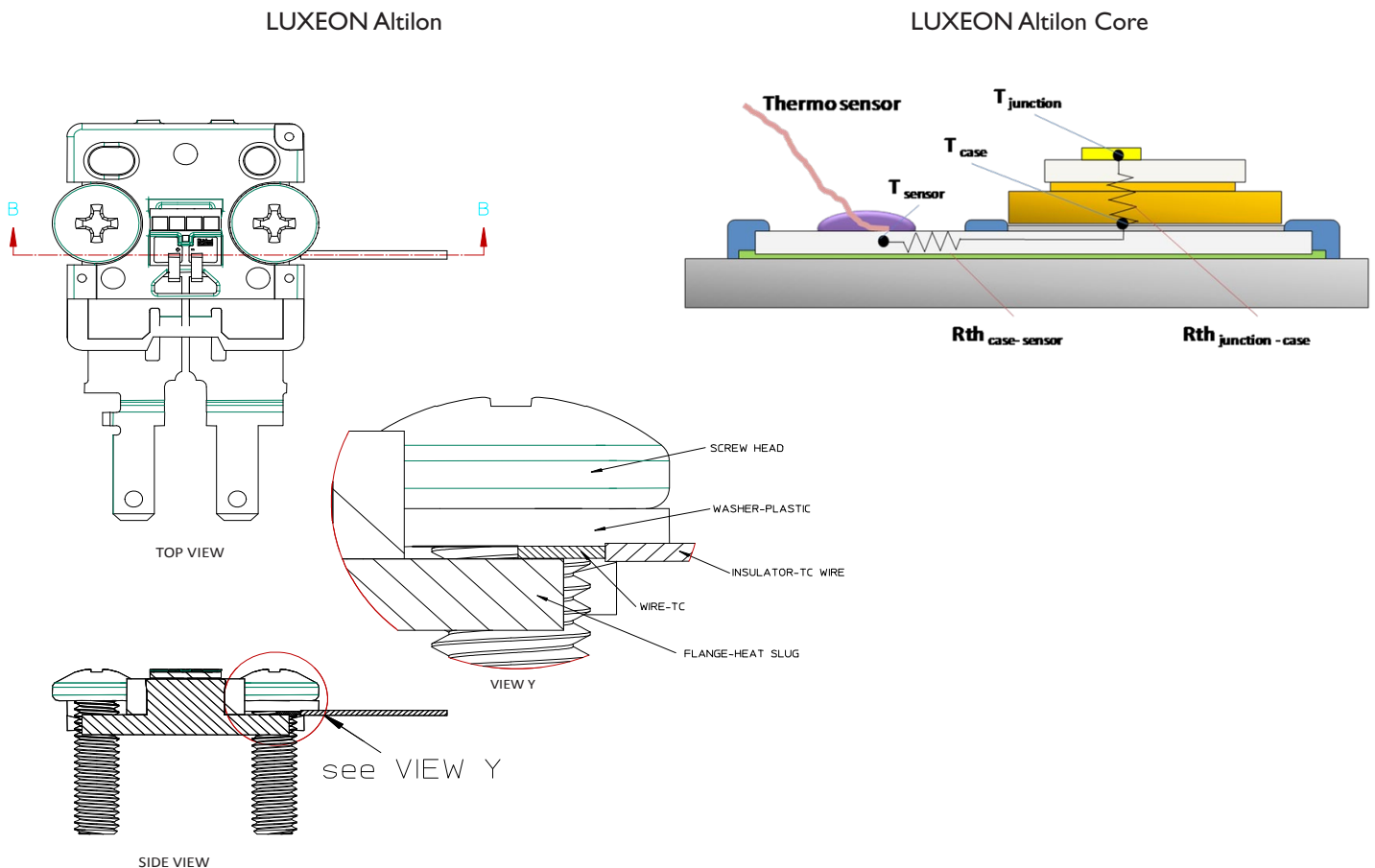

Figure 7. Case temperature measurement.

Mechanical Dimensions

LUXEON Altilon

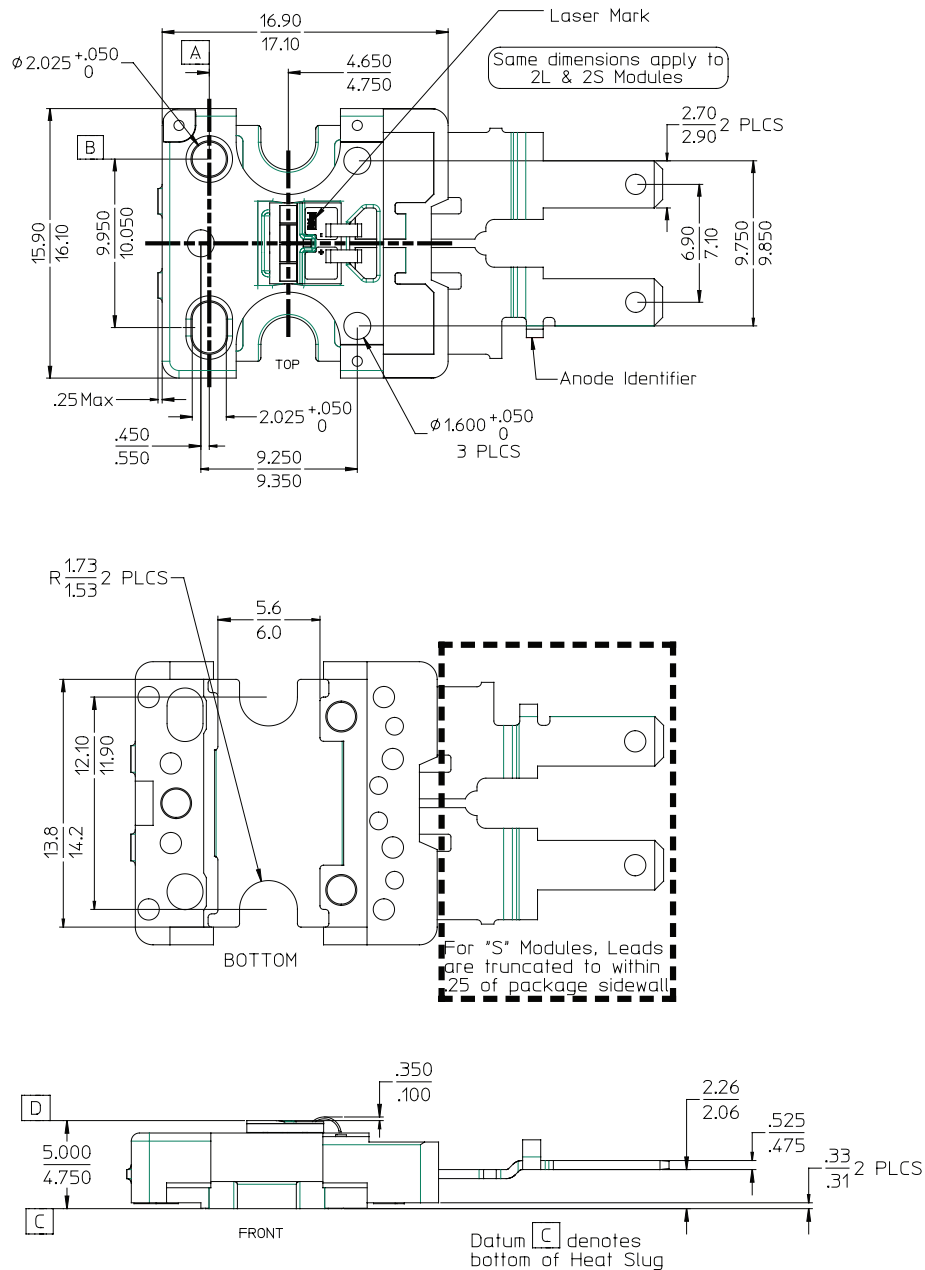

Figure 8. Mechanical dimensions for 1x2 solder pad configuration electrical connection.

Notes for Figure 8:

1. Drawings are not to scale.
2. All dimensions are in millimeters.
3. Tolerance, unless otherwise specified: ± 0.10 mm.
4. Materials: Lead frame = Tin Brass; Heat Slug = Copper; Body = LCP, Matte Black.
5. Lead frame and heat slug plated with $0.10 \mu\text{m}$ Gold over $2.5 \mu\text{m}$ Nickel.
6. Cleanliness: Parts are tested for solderability per MIL-STD-883, Method 2003 & 2004.

LUXEON Altilon Core IX4

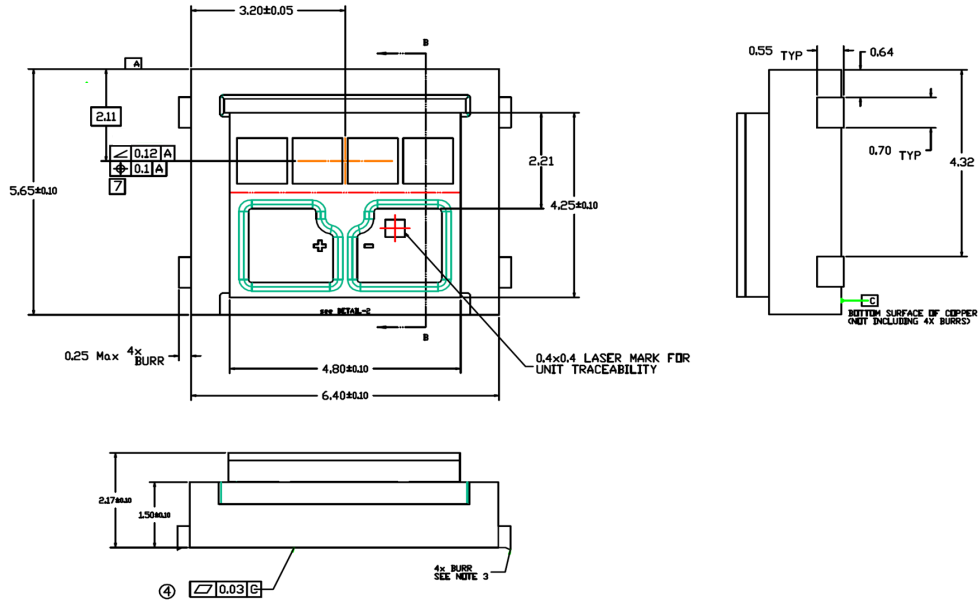

Figure 9. Mechanical dimensions for 1x4 LUXEON Altilon Core.

LUXEON Altilon Core IX2

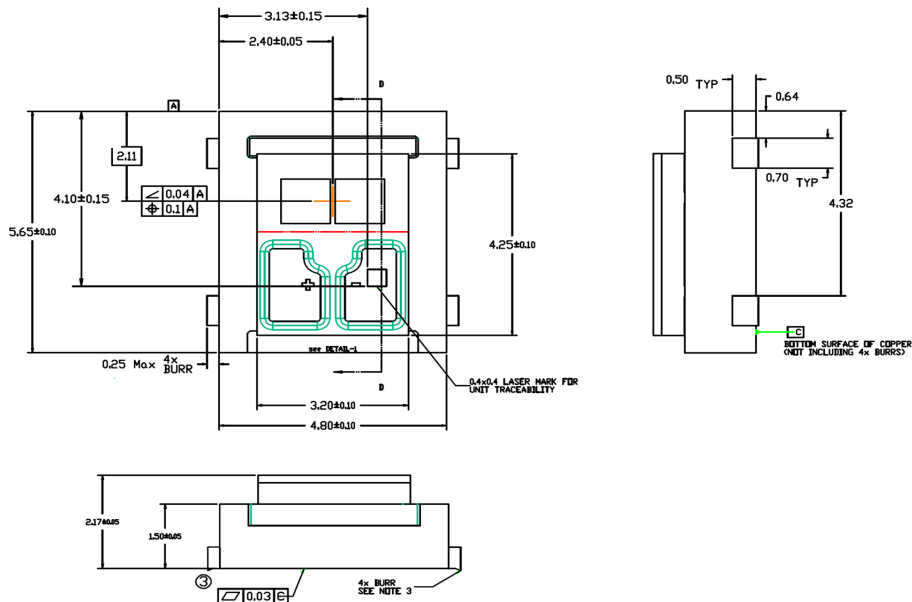

Figure 10. Mechanical dimensions for 1x2 LUXEON Altilon Core.

Notes for Figures 9 & 10:

1. Drawings are not to scale.
2. All dimensions are in millimeters.
3. Tolerance, unless otherwise specified: ± 0.10 mm.
4. Materials: Base: Copper; Substrate: Ceramic.
5. Cleanliness: Parts are tested for solderability per MIL-STD-883, Method 2003 & 2004.

Color Bin Definitions

Case Temperature $T_c = 25^\circ\text{C}$, 1000 mA Pulsed (20 msec)

Product is tested at 1000 mA Pulsed (20 msec) at an operating case temperature of 25°C . The color specification is defined in Figure 11 and the coordinate table shown below.

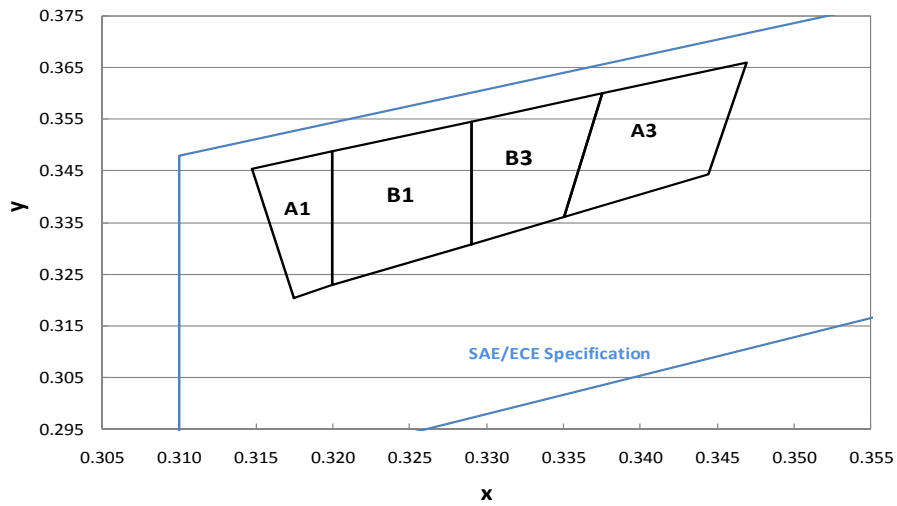

Figure 11. LUXEON Altilon color binning structure.

Table 7.

Automotive Color Binning Structure

Bin Code	X	Y	Typical CCT (K)	Bin Code	X	Y	Typical CCT (K)
B1	0.32	0.323	5700	A1	0.317466	0.320438	6000
	0.32	0.3488			0.314792	0.345467	
	0.329	0.3546			0.32	0.3488	
	0.329	0.3308			0.32	0.323	
B3	0.329	0.3308	5500	A3	0.335	0.336	5200
	0.329	0.3546			0.3375	0.36	
	0.3375	0.36			0.346904	0.366019	
	0.335	0.336			0.344443	0.344232	

Notes for Table 7:

1. Typical CRI (Color Rendering Index) is 70.
2. Philips Lumileds maintains a tolerance of ± 0.005 on X and Y chromaticity measurements.

Laser Marking Definitions

Laser Marking Definition	
TileID + Bincode + unit location at tile	I23456-000 9999
TileID (YYMMDD - Serial Running Number)	I23456-000
Bincode (Presented as PNP bin with lookup table)	
Unit location at tile	9999

Table 8. 1X2 Lookup Table

PNP Bin	Catcode
1	HB1A
2	JB1A
3	KB1A
4	LB1A
5	HB3A
6	JB3A
7	KB3A
8	LB3A
9	HA1A
10	JA1A
11	KA1A
12	LA1A
13	HA3A
14	JA3A
15	KA3A
16	LA3A
17	RA1A
18	RA3A
19	RB1A
20	RB3A

Table 9. 1X4 Lookup Table

PNP Bin	Bincat
51	MB1A
52	NB1A
53	PB1A
54	QB1A
55	MB3A
56	NB3A
57	PB3A
58	QB3A
59	MA1A
60	NA1A
61	PA1A
62	QA1A
63	MA3A
64	NA3A
65	PA3A
66	QA3A
67	SA1A
68	SA3A
69	SB1A
70	SB3A
71	WA1A
72	WA3A
73	WB1A
74	WB3A
75	XA1A
76	XA3A
77	XB1A
78	XB3A
79	YA1A
80	YA3A
81	YB1A
82	YB3A

Flux Bin Definitions

Flux Bin Definitions

for Case Temperature $T_c = 25^\circ\text{C}$, 1000 mA Pulsed (20 msec)

The table below shows the luminous flux bin structure, tested and binned at 1000 mA pulsed (20 msec), $T_c = 25^\circ\text{C}$.

Table 10.

Applicable Product	Bin Code	Minimum Photometric Flux (Lm)	Maximum Photometric Flux (Lm)
1x2	H	350	425
	J	425	465
	R	465	500
	K	500	600
1x4	M	700	850
	N	850	925
	S	925	1000
	P	1000	1050
	W	1050	1100
	X	1100	1150
	Y	1150	1200
	Q	1200	1400

Typical Spectrum

Case Temperature $T_c = 25^\circ\text{C}$, 1000 mA Pulsed (20 msec)

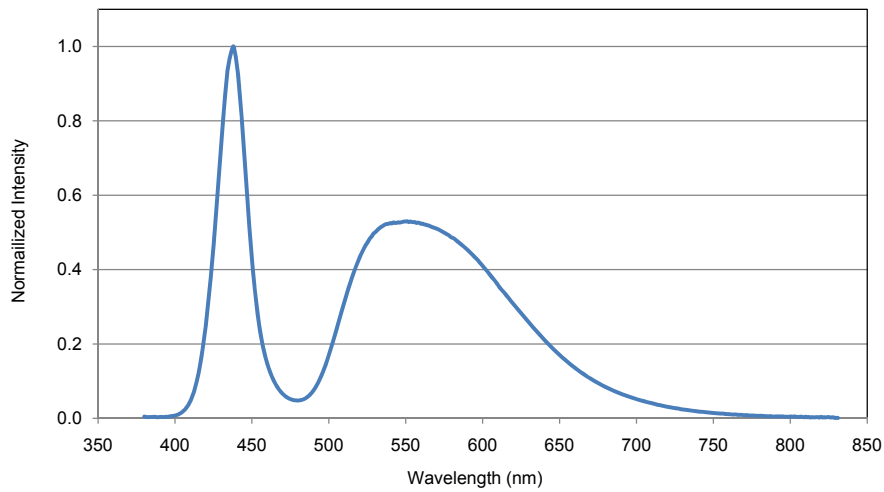

Figure 12. Color spectrum of typical CCT part, integrated measurement.

Typical Color vs. Angle

Applicable for DC Current Range of 350 mA to 1000 mA

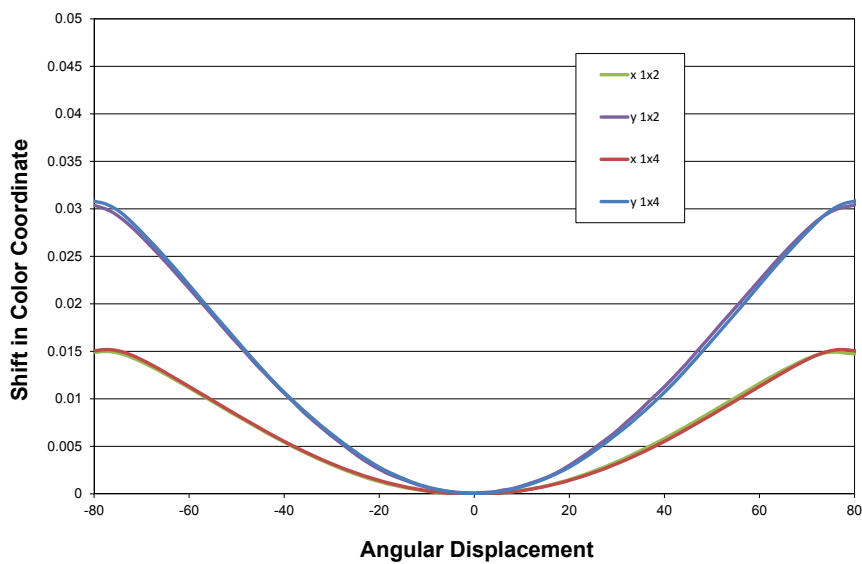

Figure 13. Typical color shift in x,y chromaticity over angle.

Color Shift vs. Case Temperature

Color Shift vs. Case Temperature

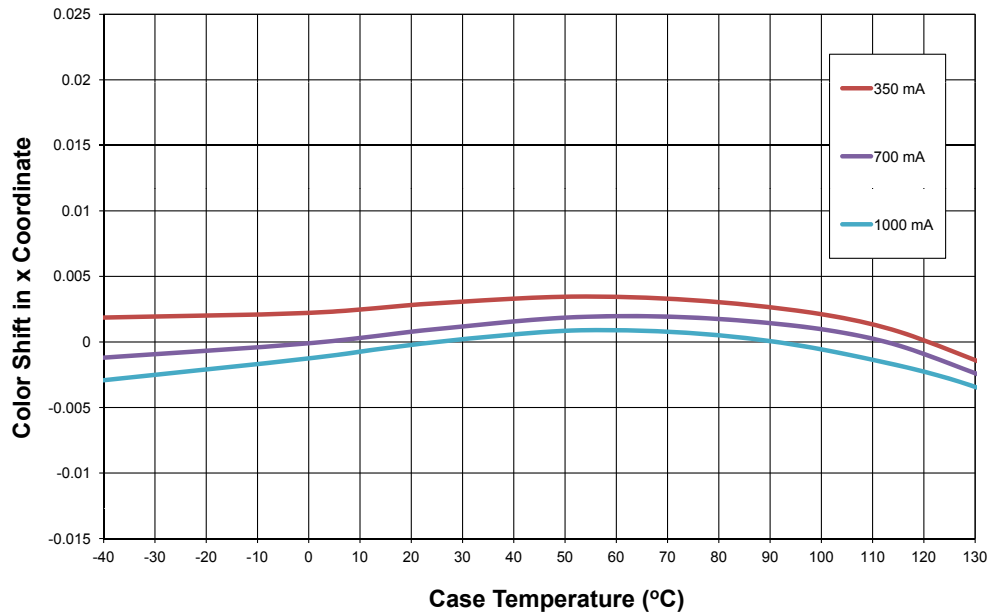

Figure 14. Typical change in x chromaticity vs. case temperature.

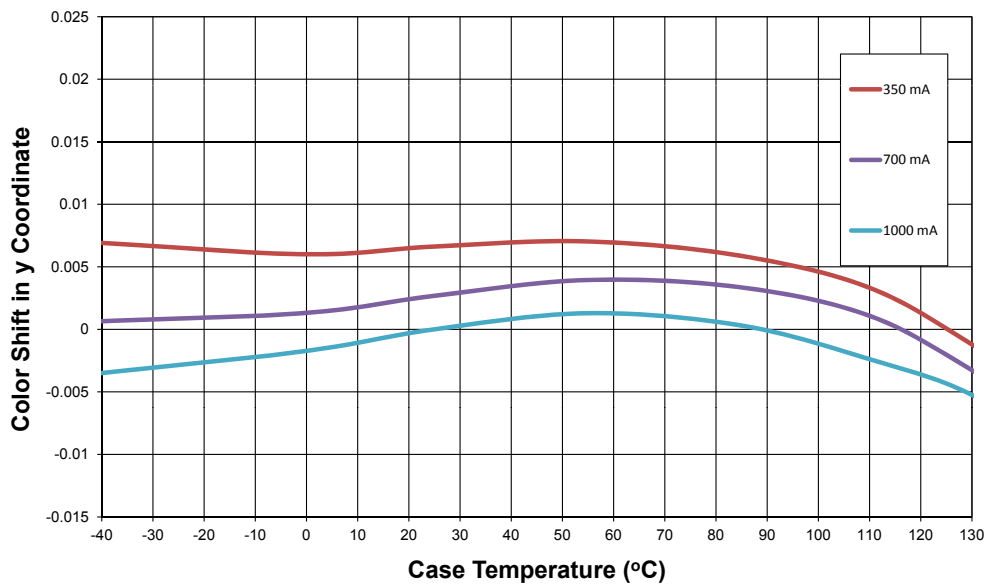

Figure 15. Typical change in y chromaticity vs. case temperature.

Color Shift vs. DC Drive Current

Color Shift vs. DC Drive Current

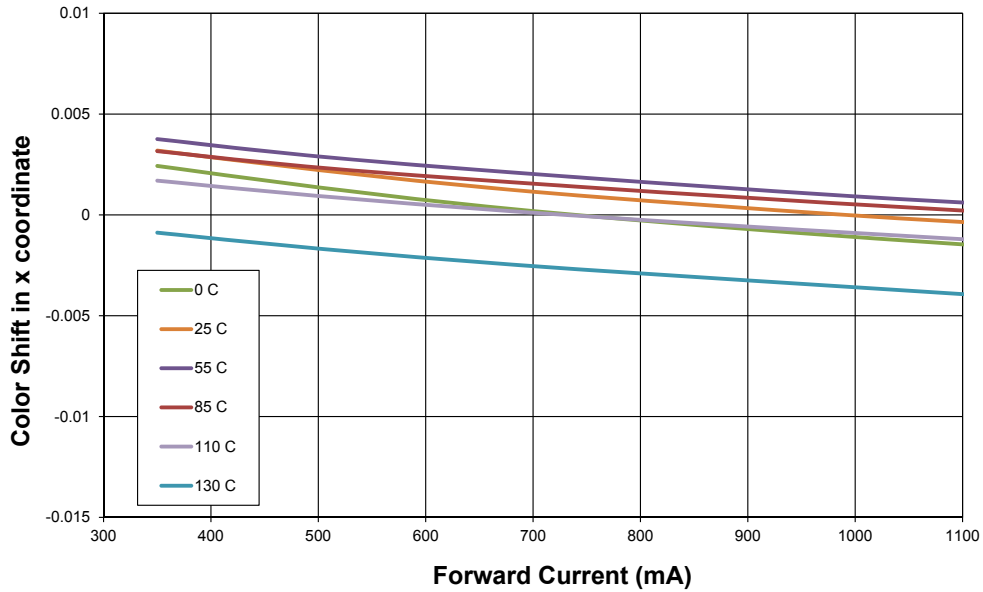

Figure 16. Typical change in x chromaticity vs. drive current.

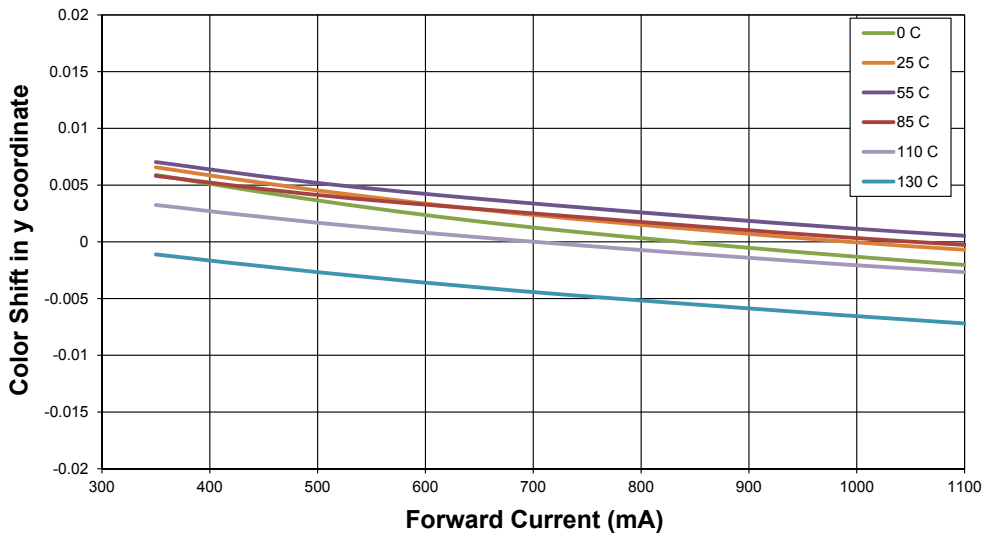

Figure 17. Typical change in y chromaticity vs. drive current.

Typical Radiation Pattern

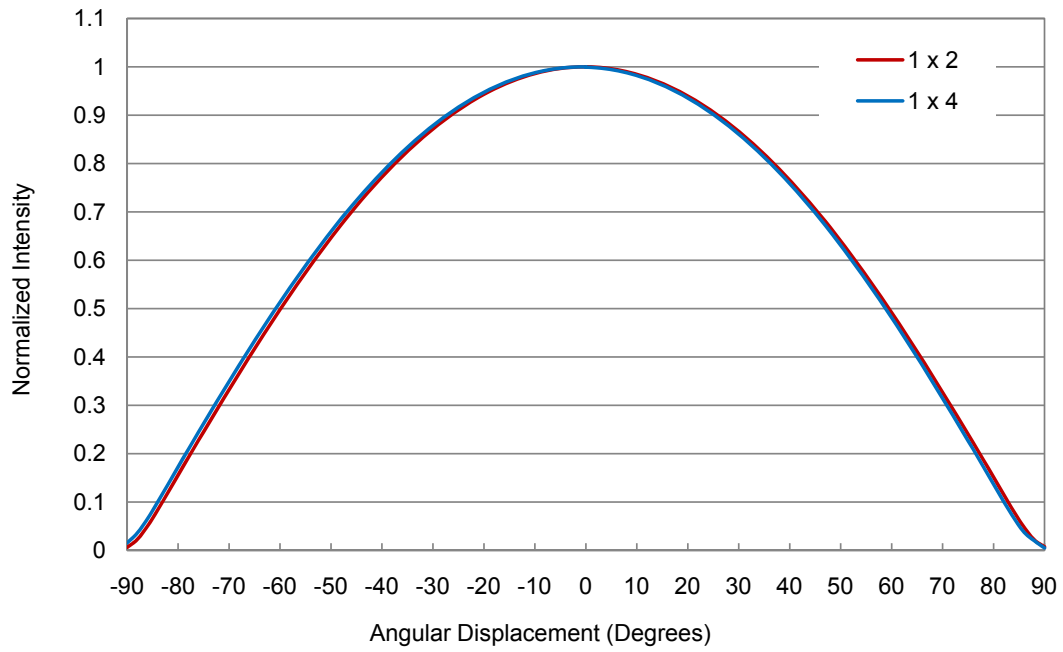
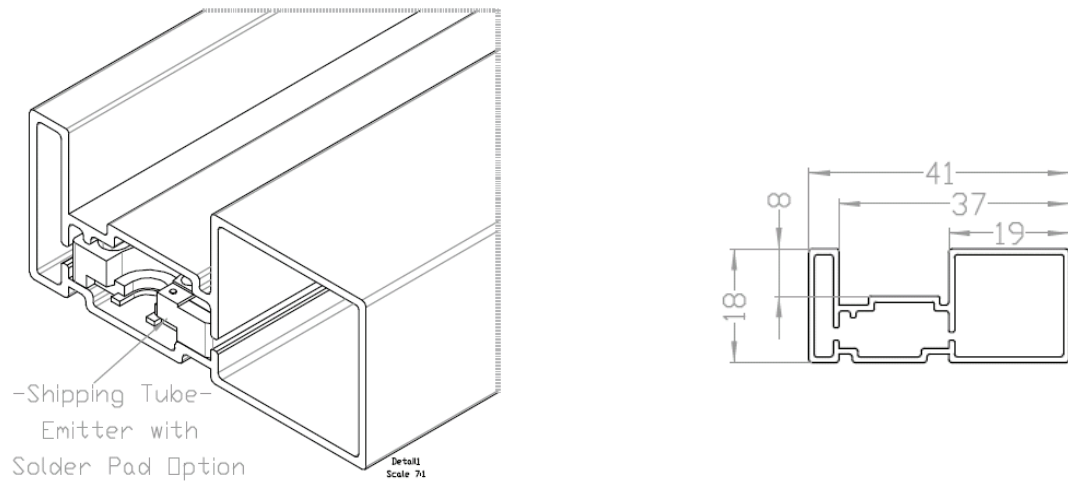

Figure 18. Typical representative spatial radiation pattern.

Packing Information

The LUXEON Altilon product will be shipped in tubes as shown below.



Notes:

1. Drawings are not to scale.
2. All dimensions are in millimeters.
3. Tube length: 700 mm, capacity: 42 LEDs.
4. Expected weight: full approximately 275g, empty approximately 120g.
5. Material: clear PVC with ESD-coating.

Tubes will be packed into bundles of 15 tubes maximum and shipped in boxes measuring 759mm long by 229mm wide by 81 mm deep.

LUXEON Altilon Core Packaging for IX4 Configuration

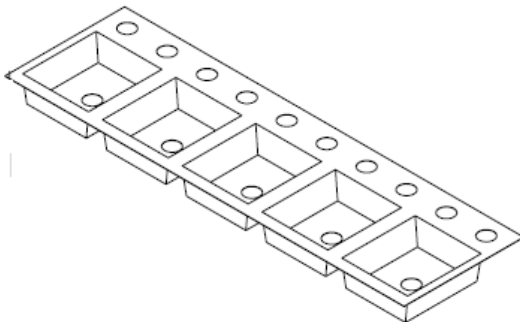
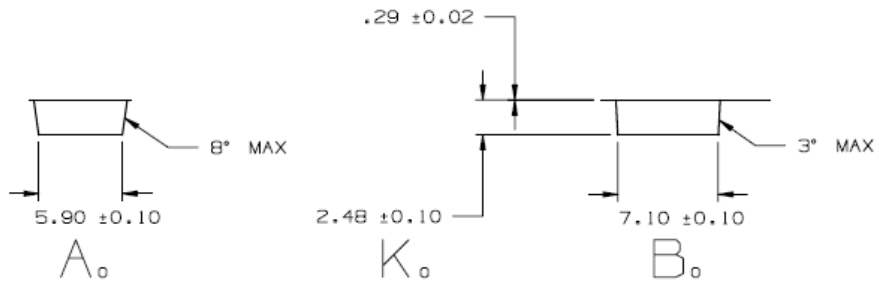
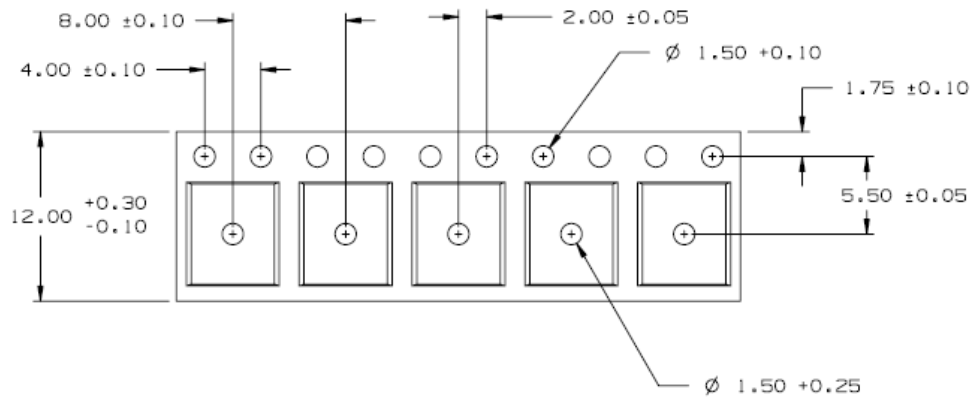

THE DIMENSIONS SHOWN ON THIS PROPOSED DRAWING ARE FOR ILLUSTRATIVE PURPOSE. DIMENSIONS FROM ACTUAL CARRIER MAY VARY SLIGHTLY.

LUXEON Altilon Core Packaging for IX2 Configuration

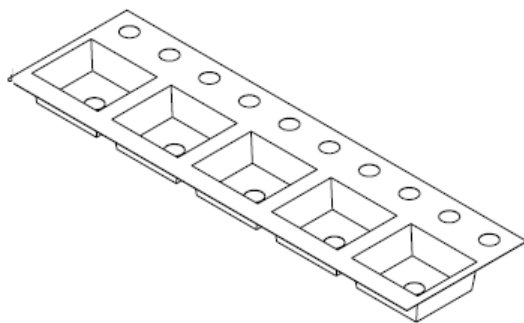
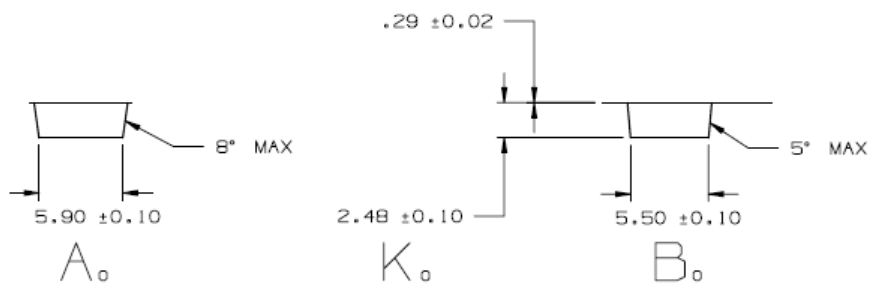
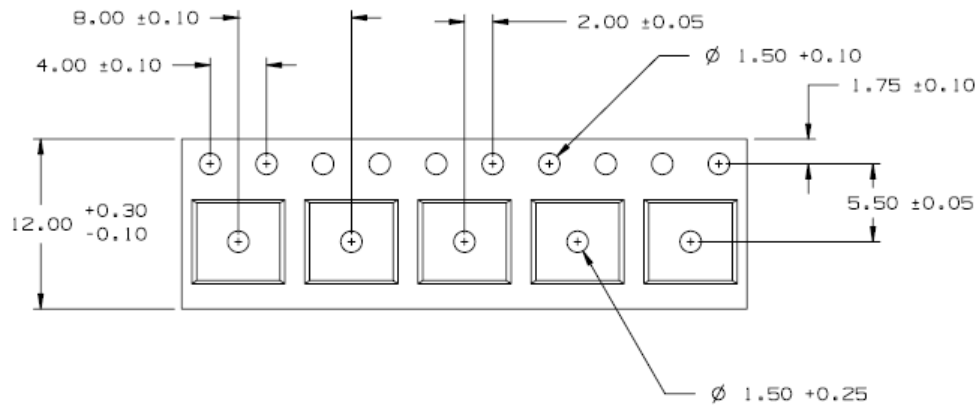

THE DIMENSIONS SHOWN ON THIS PROPOSED DRAWING ARE FOR ILLUSTRATIVE PURPOSE. DIMENSIONS FROM ACTUAL CARRIER MAY VARY SLIGHTLY.

Product Labeling Information

Each tube of LUXEON Alticon will be labeled as shown below:



QTY = number of parts in shipping tube or reel

CAT code = four character alpha category code with flux bin, color bin, and voltage bin. In the example shown above, flux bin = **N**, color bin = **B**, and forward voltage bin = **A** (full distribution of voltage specification).

Part No. consists of standard notation **LAFL - C#S** or **LACL - C#S** where # is the number of emitters. The last four character string is the minimum flux specification in lumens.

Each box will have a box label as shown below.

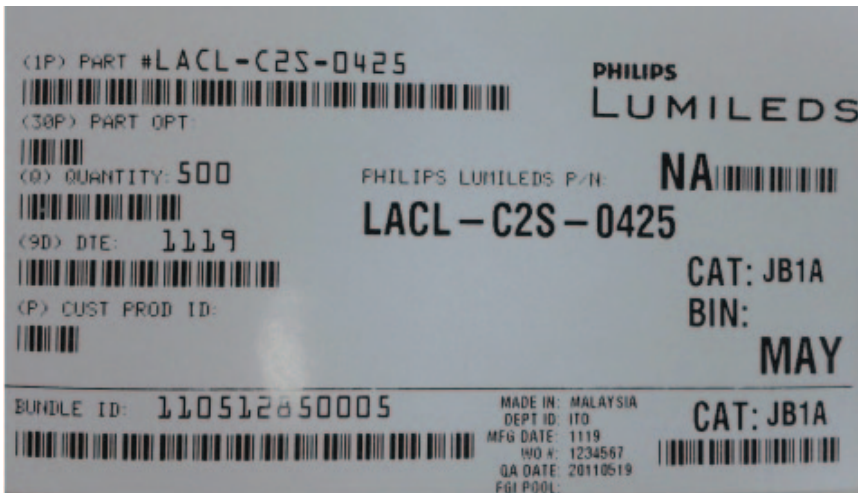

The label indicates the part number of the LUXEON Alticon product with the CAT code and the quantity of products contained inside the box.

Company Information

Philips Lumileds is a leading provider of LEDs for everyday lighting applications. The company's records for light output, efficacy and thermal management are direct results of the ongoing commitment to advancing solid-state lighting technology and enabling lighting solutions that are more environmentally friendly, help reduce CO₂ emissions and reduce the need for power plant expansion. Philips Lumileds LUXEON® LEDs are enabling never before possible applications in outdoor lighting, shop lighting, home lighting, consumer electronics, and automotive lighting.

Philips Lumileds is a fully integrated supplier, producing core LED material in all three base colors, (Red, Green, Blue) and white. Philips Lumileds has R&D centers in San Jose, California and in the Netherlands, and production capabilities in San Jose, Singapore and Penang, Malaysia. Founded in 1999, Philips Lumileds is the high flux LED technology leader and is dedicated to bridging the gap between solid-state technology and the lighting world. More information about the company's LUXEON LED products and solid-state lighting technologies can be found at www.philipslumileds.com.

©2013 Philips Lumileds Lighting Company. All rights reserved.
Product specifications are subject to change without notice.

PHILIPS
LUMILEDS

www.philipslumileds.com
www.philipslumileds.cn.com