

## Features

- Inventronics patented metal case (Patent NO.: 201530552645.1)
- High Efficiency (Up to 93%)
- Full Power at Wide Output Current Range (Constant Power)
- Adjustable Output Current (AOC) with Potentiometer (SV models)  
Adjustable Output Current (AOC) with Programmability (DV models)
- 0-10V/PWM Dimmable (Only DV models)
- Input Surge Protection: 4kV line-line, 4kV line-earth
- All-Around Protection: OVP, SCP, OTP
- Waterproof (IP65)
- SELV Output
- Suitable for Independent Use
- 5 Years Warranty



## Description

The *EUR-240SxxxDV(SV)* series is a 240W, constant-current, AOC LED driver that operates from 90-305 Vac input with excellent power factor. It is designed in round shape and specially created for bay lighting. The high efficiency of these drivers and compact metal case enables them to run cooler, significantly improving reliability and extending product life. To ensure trouble-free operation, protection is provided against input surge, output over voltage, short circuit, and over temperature.

## Models

Adjustable Output Current Range	Full-Power Current Range (1)	Default Output Current	Input Voltage Range (2)	Output Voltage Range	Max. Output Power	Typical Efficiency (3)	Power Factor		Model Number (4)
							120Vac	220Vac	
280-4200mA	2800-4200mA	4000mA	90~305 Vac/ 127~250 Vdc	29 ~ 86Vdc	240W	93.0%	0.99	0.96	EUR-240S420DV
2800-4200mA	2800-4200mA	4000mA	90~305 Vac/ 127~250 Vdc	29 ~ 86Vdc	240W	93.0%	0.99	0.96	EUR-240S420SV
445-6700mA	4450-6700mA	5000mA	90~305 Vac/ 127~250 Vdc	18 ~ 54Vdc	240W	92.5%	0.99	0.96	EUR-240S670DV
4450-6700mA	4450-6700mA	5000mA	90~305 Vac/ 127~250 Vdc	18 ~ 54Vdc	240W	92.5%	0.99	0.96	EUR-240S670SV

- Notes:** (1) Output current range with constant power at 240W  
 (2) Certified voltage range: 100-240Vac or 127-250Vdc (except CCC, PSE and KS)  
 (3) Measured at full load and 220Vac input (see below "General Specifications" for details).  
 (4) SELV Output.

## I-V Operation Area

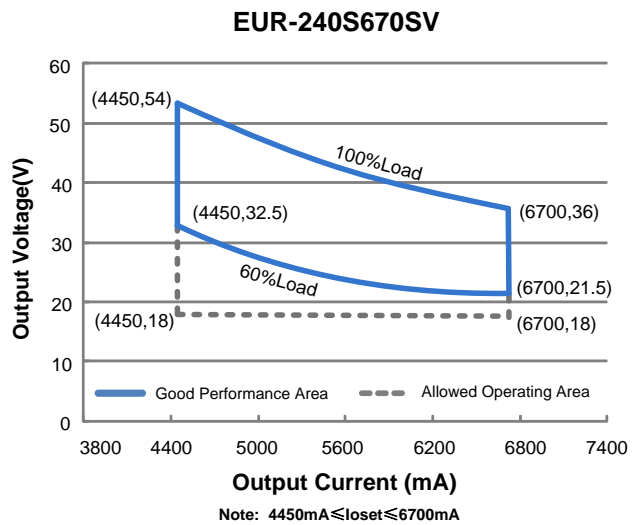
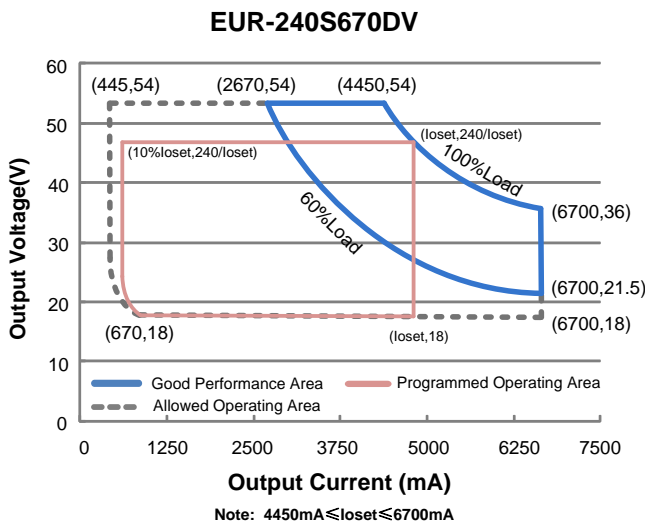
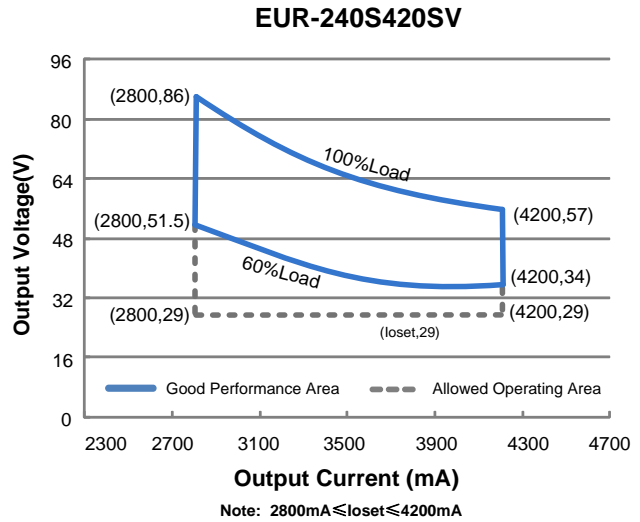
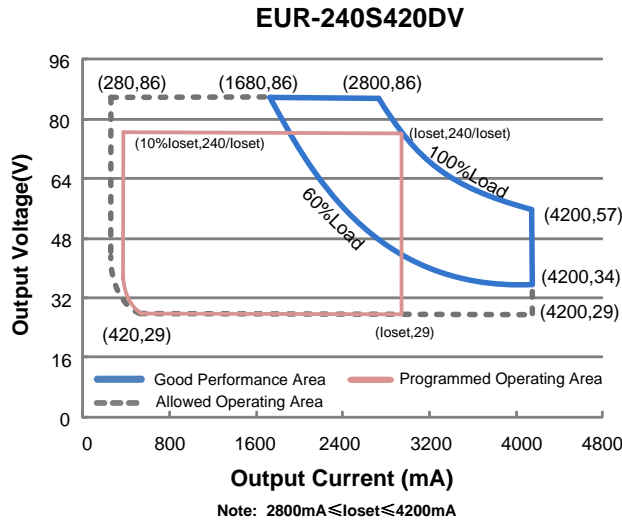

## Input Specifications

Parameter	Min.	Typ.	Max.	Notes
Input Voltage	90 Vac	-	305 Vac	127~250 Vdc
Input Frequency	47 Hz	-	63 Hz	
Leakage Current	-	-	0.70 mA	IEC60598-1; 240Vac/ 60Hz
Input AC Current	-	-	3.10 A	Measured at full load and 100 Vac input.
	-	-	1.40 A	Measured at full load and 220 Vac input.
Inrush Current(I <sup>2</sup> t)	-	-	2.70 A <sup>2</sup> s	At 220Vac input, 25°C cold start, duration=2.36 ms, 10%I <sub>pk</sub> -10%I <sub>pk</sub> . See Inrush Current Waveform for the details.

## Input Specifications (Continued)

Parameter	Min.	Typ.	Max.	Notes
PF	0.90	-	-	At 100-240Vac, 50-60Hz, 60%-100% Load (144-240W)
THD	-	-	20%	
THD	-	-	10%	At 220-240Vac, 50-60Hz, 75%-100% Load (180-240W)

## Output Specifications

Parameter	Min.	Typ.	Max.	Notes
Output Current Tolerance	-5%loset	-	5%loset	At full load condition
Output Current Setting(loset) Range				
EUR-240S420DV	280 mA	-	4200 mA	
EUR-240S420SV	2800 mA	-	4200 mA	
EUR-240S670DV	445 mA	-	6700 mA	
EUR-240S670SV	4450 mA	-	6700 mA	
Output Current Setting Range with Constant Power				
EUR-240S420DV	2800 mA	-	4200 mA	
EUR-240S420SV	2800 mA	-	4200 mA	
EUR-240S670DV	4450 mA	-	6700 mA	
EUR-240S670SV	4450 mA	-	6700 mA	
Total Output Current Ripple (pk-pk)	-	5%lomax	10%lomax	At full load condition. 20 MHz BW
Output Current Ripple at < 200 Hz (pk-pk)	-	2%lomax	-	At full load condition. Only this component of ripple is associated with visible flicker.
Startup Overshoot Current	-	-	10%lomax	At full load condition
No Load Output Voltage				
EUR-240S420DV/SV	-	-	95 V	
EUR-240S670DV/SV	-	-	65 V	
Line Regulation	-	-	±0.5%	Measured at full load
Load Regulation	-	-	±1.5%	
Turn-on Delay Time	-	-	1.0 s	Measured at 120Vac input, 60%-100% Load
	-	-	0.5 s	Measured at 220Vac input, 60%-100% Load
Temperature Coefficient of loset	-	-	0.03%/°C	Case temperature = 0°C ~Tc max
12V Auxiliary Output Voltage	10.8 V	12 V	13.2 V	
12V Auxiliary Output Source Current	0 mA	-	20 mA	Return terminal is "Dim"

**Note:** All specifications are typical at 25°C unless otherwise stated.

## General Specifications

Parameter	Min.	Typ.	Max.	Notes
Efficiency at 120 Vac input: EUR-240S420DV/SV I <sub>o</sub> =2800 mA I <sub>o</sub> =4200 mA EUR-240S670DV/SV I <sub>o</sub> =4450 mA I <sub>o</sub> =6700 mA	88.5% 87.0%	90.5% 89.0%	- -	Measured at full load and steady-state temperature in 25°C ambient; (Efficiency will be about 2.0% lower if measured immediately after startup.)
Efficiency at 220 Vac input: EUR-240S420DV/SV I <sub>o</sub> =2800 mA I <sub>o</sub> =4200 mA EUR-240S670DV/SV I <sub>o</sub> =4450 mA I <sub>o</sub> =6700 mA	91.0% 89.5%	93.0% 91.5%	- -	Measured at full load and steady-state temperature in 25°C ambient; (Efficiency will be about 2.0% lower if measured immediately after startup.)
Efficiency at 277 Vac input: EUR-240S420DV/SV I <sub>o</sub> =2800 mA I <sub>o</sub> =4200 mA EUR-240S670DV/SV I <sub>o</sub> =4450 mA I <sub>o</sub> =6700 mA	91.5% 89.5%	93.5% 91.5%	- -	Measured at full load and steady-state temperature in 25°C ambient; (Efficiency will be about 2.0% lower if measured immediately after startup.)
MTBF	-	438,000 Hours	-	Measured at 220Vac input, 80%Load and 25°C ambient temperature (MIL-HDBK-217F)
Lifetime	-	65,000 Hours	-	Measured at 220Vac input, 80%Load and 70°C case temperature; See lifetime vs. T <sub>c</sub> curve for the details
Operating Case Temperature for Safety T <sub>c_s</sub>	-40°C	-	+85°C	
Operating Case Temperature for Warranty T <sub>c_w</sub>	-40°C	-	+75°C	Case temperature for 5 years warranty
Storage Temperature	-40°C	-	+85°C	Humidity: 5%RH to 100%RH
Dimensions Inches (∅x H) Millimeters (∅x H)	∅7.48 x 3.13 ∅190 x 79.6			
Net Weight	-	2280 g	-	

**Note:** All specifications are typical at 25°C unless otherwise stated.

## Dimming Specifications

Parameter	Min.	Typ.	Max.	Notes	
Absolute Maximum Voltage on the V <sub>dim</sub> (+) Pin	-20 V	-	20 V		
Source Current on V <sub>dim</sub> (+)Pin	200 uA	300 uA	450 uA	V <sub>dim</sub> (+) = 0 V	
Dimming Output Range	EUR-240S420DV EUR-240S670DV	10%loset	-	loset	2800 mA ≤ I <sub>o</sub> set ≤ 4200 mA 4450 mA ≤ I <sub>o</sub> set ≤ 6700 mA
	EUR-240S420DV EUR-240S670DV	280 mA 445 mA	-	loset	280 mA ≤ I <sub>o</sub> set < 2800 mA 445 mA ≤ I <sub>o</sub> set < 4450 mA
Recommended Dimming Input Range	0 V	-	10 V	Default 0-10V dimming mode.	

## Dimming Specifications (Continued)

Parameter	Min.	Typ.	Max.	Notes
PWM_in High Level	3 V	-	10 V	Dimming mode set to PWM in PC interface.
PWM_in Low Level	-0.3 V	-	0.6 V	
PWM_in Frequency Range	200 Hz	-	2 KHz	
PWM_in Duty Cycle	1%	-	99%	

## Safety & EMC Compliance

Safety Category	Standard
CE	EN 61347-1, EN61347-2-13
CCC	GB 19510.1, GB 19510.14
KS	KS C 7655
EMI Standards	Notes
EN 55015/GB 17743 <sup>(1)</sup>	Conducted emission Test & Radiated emission Test
EN 61000-3-2/GB 17625.1	Harmonic current emissions
EN 61000-3-3	Voltage fluctuations & flicker
EMS Standards	Notes
EN 61000-4-2	Electrostatic Discharge (ESD): 8 kV air discharge, 4 kV contact discharge
EN 61000-4-3	Radio-Frequency Electromagnetic Field Susceptibility Test-RS
EN 61000-4-4	Electrical Fast Transient / Burst-EFT
EN 61000-4-5	Surge Immunity Test: AC Power Line: line to line 4 kV, line to earth 4 kV
EN 61000-4-6	Conducted Radio Frequency Disturbances Test-CS
EN 61000-4-8	Power Frequency Magnetic Field Test
EN 61000-4-11	Voltage Dips
EN 61547	Electromagnetic Immunity Requirements Applies To Lighting Equipment

**Note:** (1) This LED driver meets the EMI specifications above, but EMI performance of a luminaire that contains it depends also on the other devices connected to the driver and on the fixture itself.

## Derating

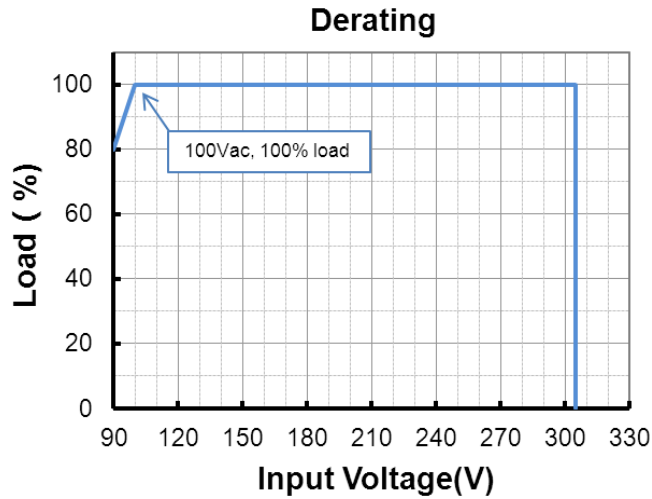

## Lifetime vs. Case Temperature

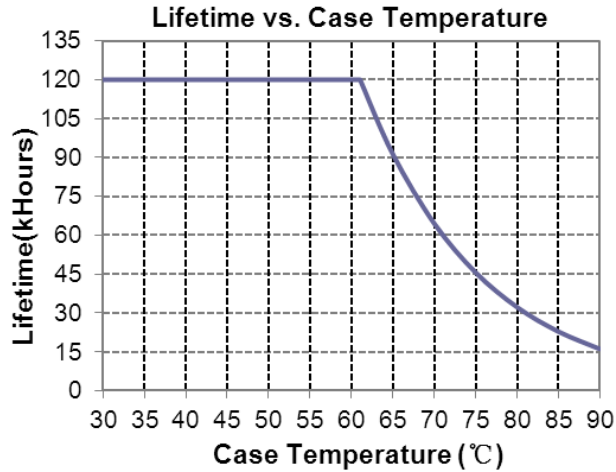

## Inrush Current Waveform

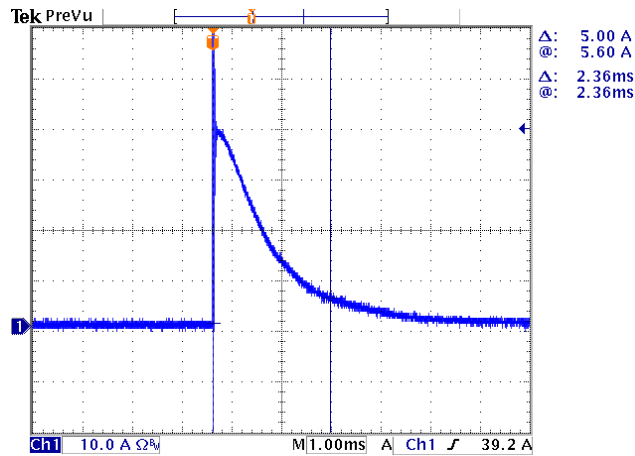

## Efficiency vs. Load

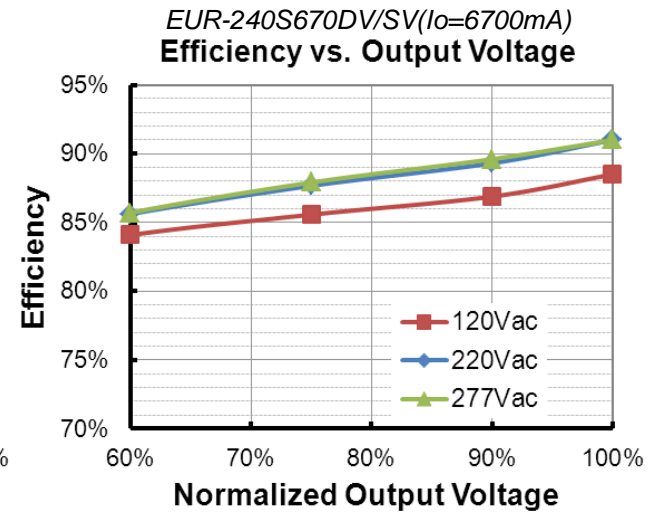
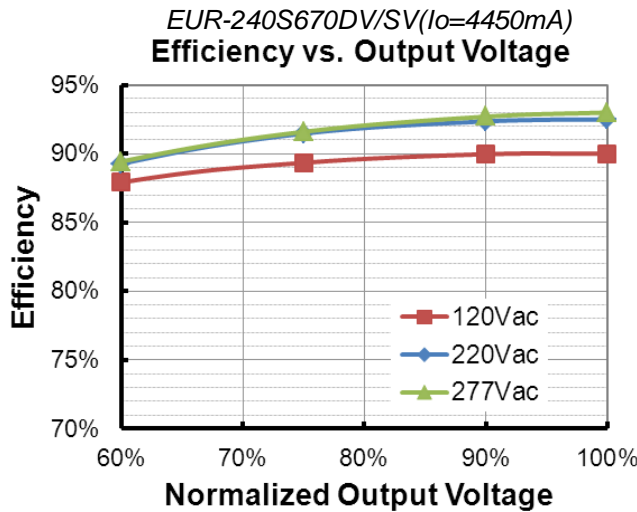
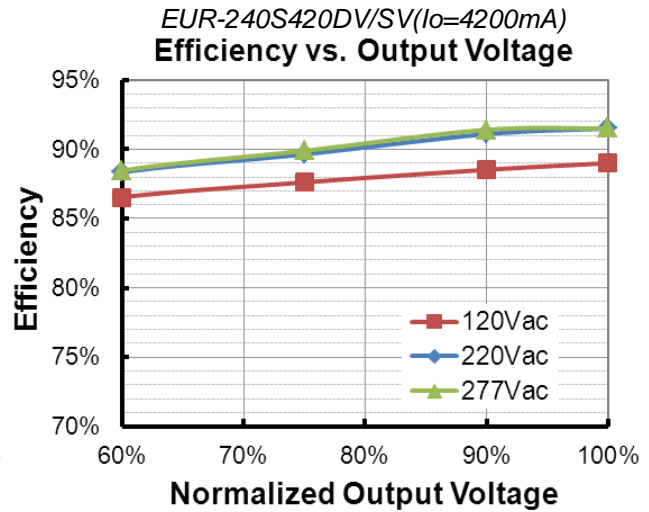
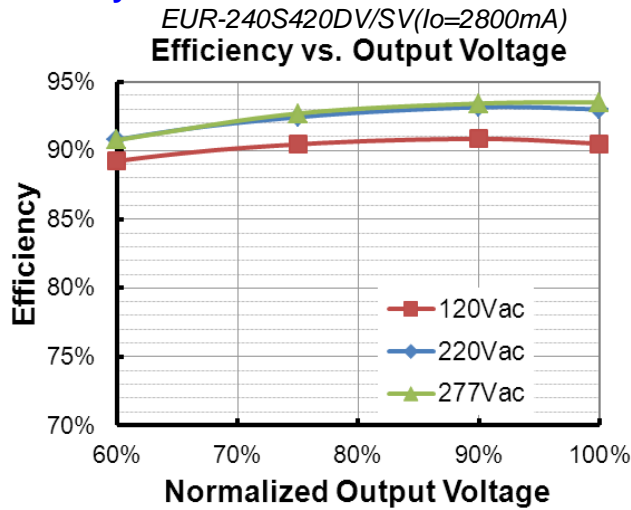

## Power Factor

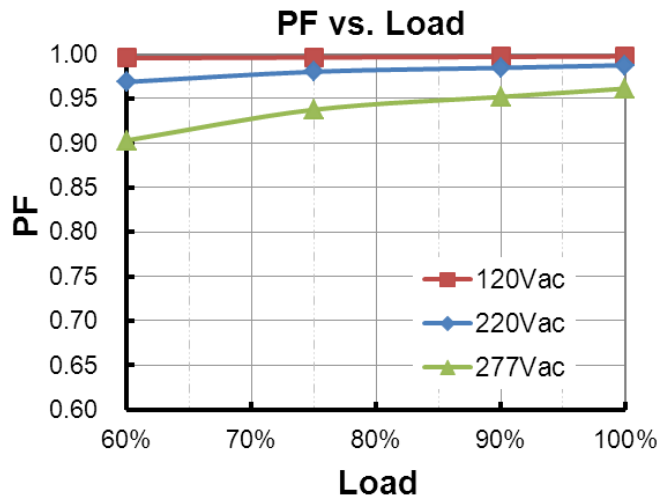

## Total Harmonic Distortion

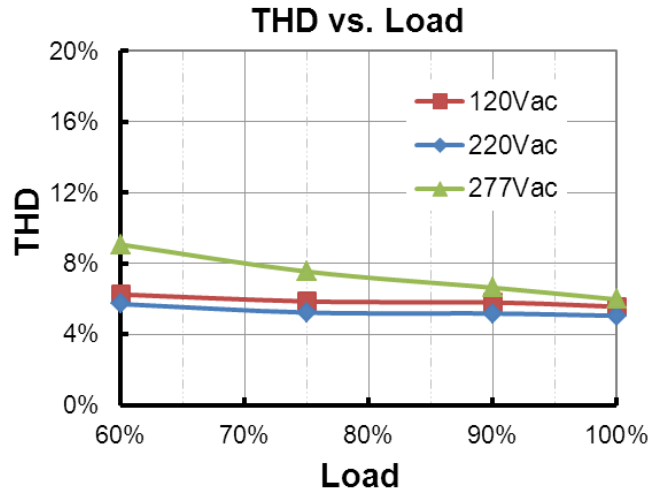

## Protection Functions

Parameter	Notes
Over Temperature Protection	Decreases output current, returning to normal after over temperature is removed.
Short Circuit Protection	Auto Recovery. No damage will occur when any output is short circuited. The output shall return to normal when the fault condition is removed.
Over Voltage Protection	Limits output voltage at no load and in case the normal voltage limit fails.

## Dimming

### ● 0-10V Dimming

The recommended implementation of the dimming control is provided below.

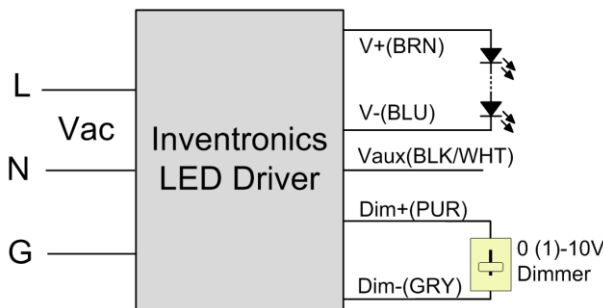

Io/IoSet vs. Dimming Voltage

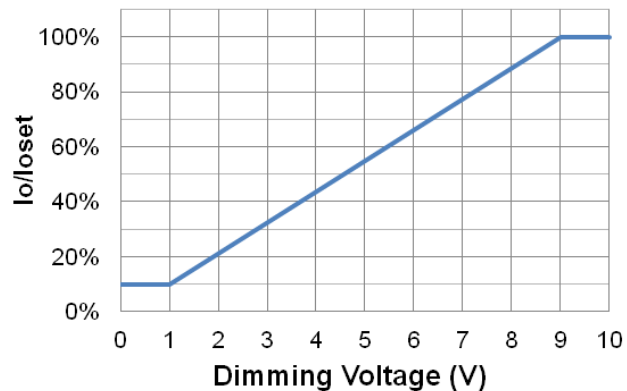

### Implementation 1: DC Input

#### Notes:

1. The dimmer can also be replaced by an active 0-10V voltage source signal or passive components like resistors and zener.
2. Do NOT connect Dim- to the output V- or V+, otherwise the driver will not work properly.
3. If 0-10V dimming is not used, Dim + should be open.



● PWM Dimming

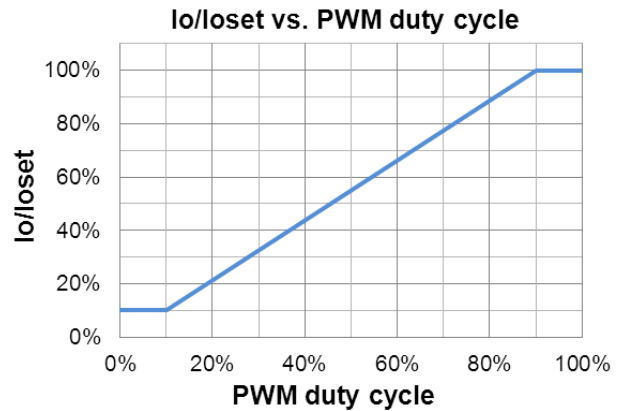
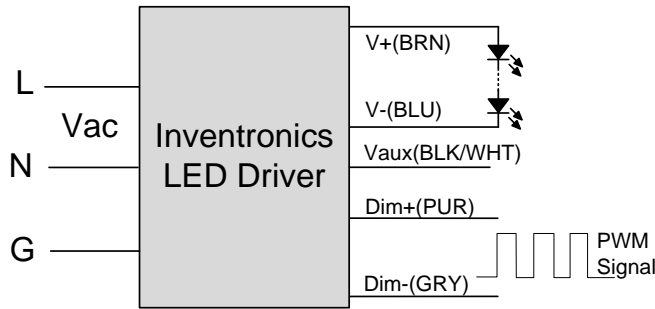

Implementation 2: Positive logic

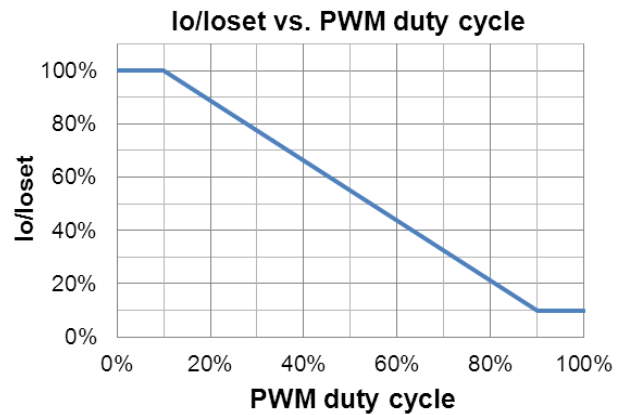
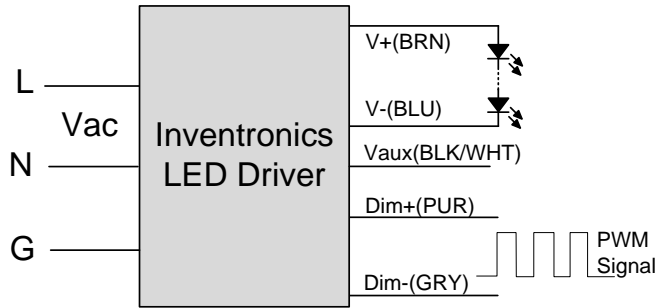

Implementation 3: Negative logic

Notes:

1. Do NOT connect Dim- to the output V- or V+, otherwise the driver will not work properly.
2. If PWM dimming is not used, Dim + should be open.
3. When PWM negative logic dimming mode and Dim+ is open, the driver will output minimum current.

## Programming Connection Diagram (Only DV models)

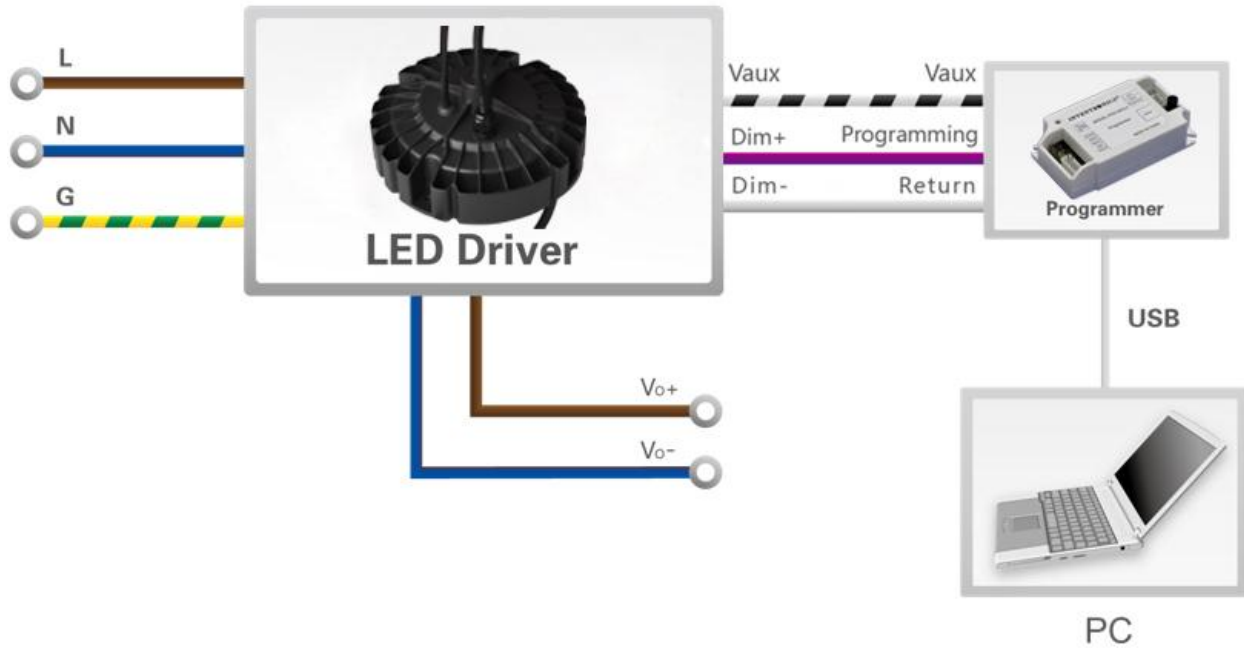

**Note:** The driver does not need to be powered on during the programming process.

- Please refer to [PRG-MUL2](#) Multi-Programmer datasheet for details.

## Installations

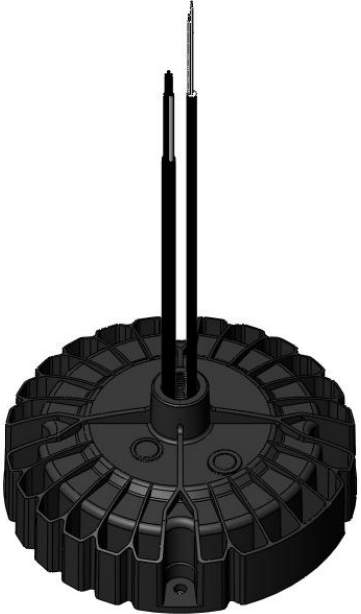
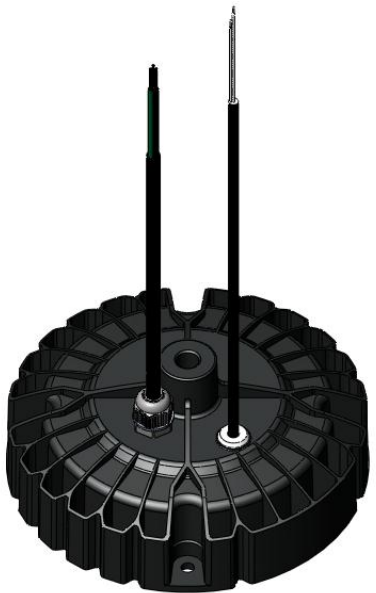
Part Number Suffix	-0000	-0001
Product Type	Center Wire Feed	Outside Wire Feed
Product Appearance		

## Installations (Continued)

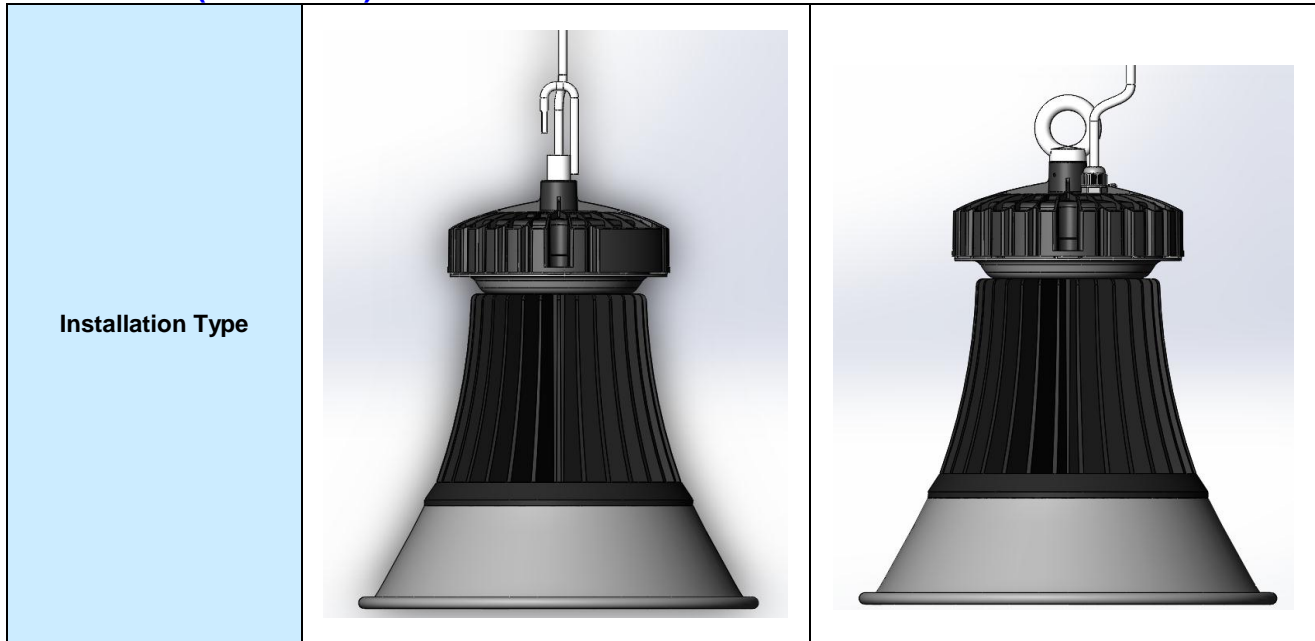

### Caution:

1. Complete visual inspection prior to assembly to insure driver is received in proper condition.
2. Thread length for mounting accessory (hook, ring, etc.) should be 16-22mm. After mounting accessory (hook, ring, etc.) is installed an M4 set screw should be secured in the open location on the driver collar.
3. Maximum weight of combined luminaire/driver assembly should not exceed 16.5Kg.

## Mechanical Outline

EUR-240SxxxDV-0000

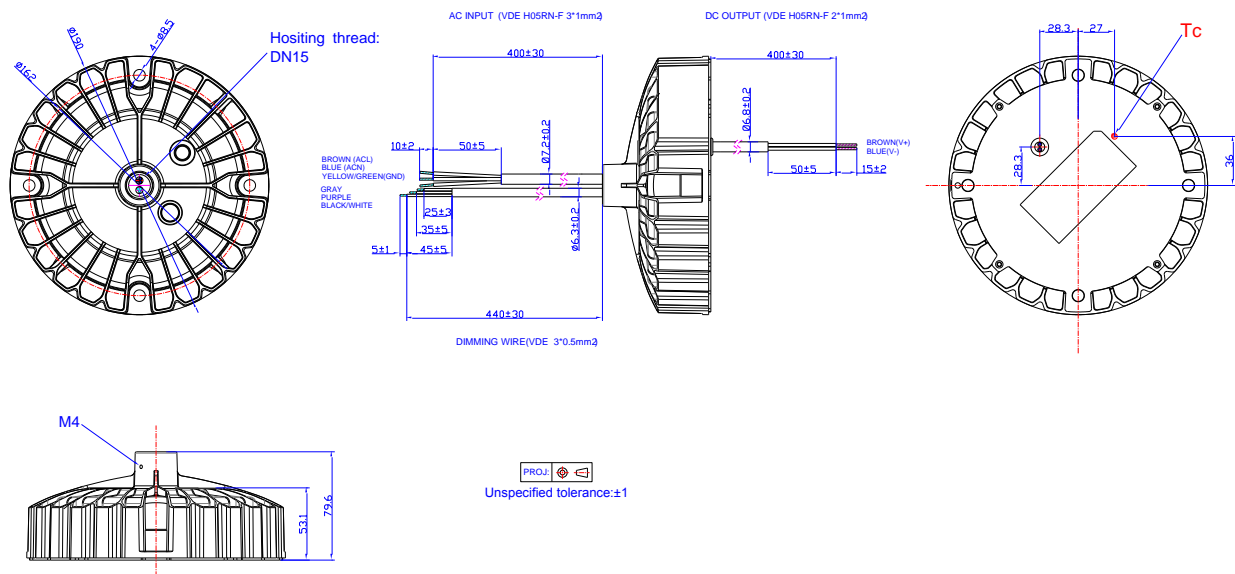

## EUR-240SxxxSV-0000

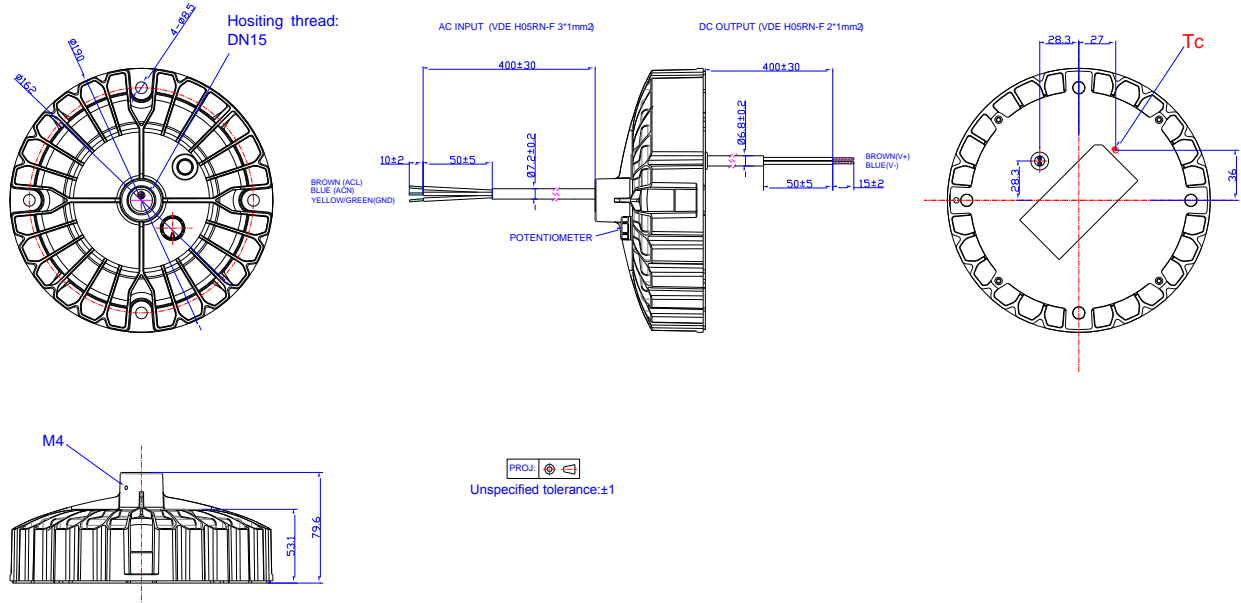

## EUR-240SxxxDV-0001

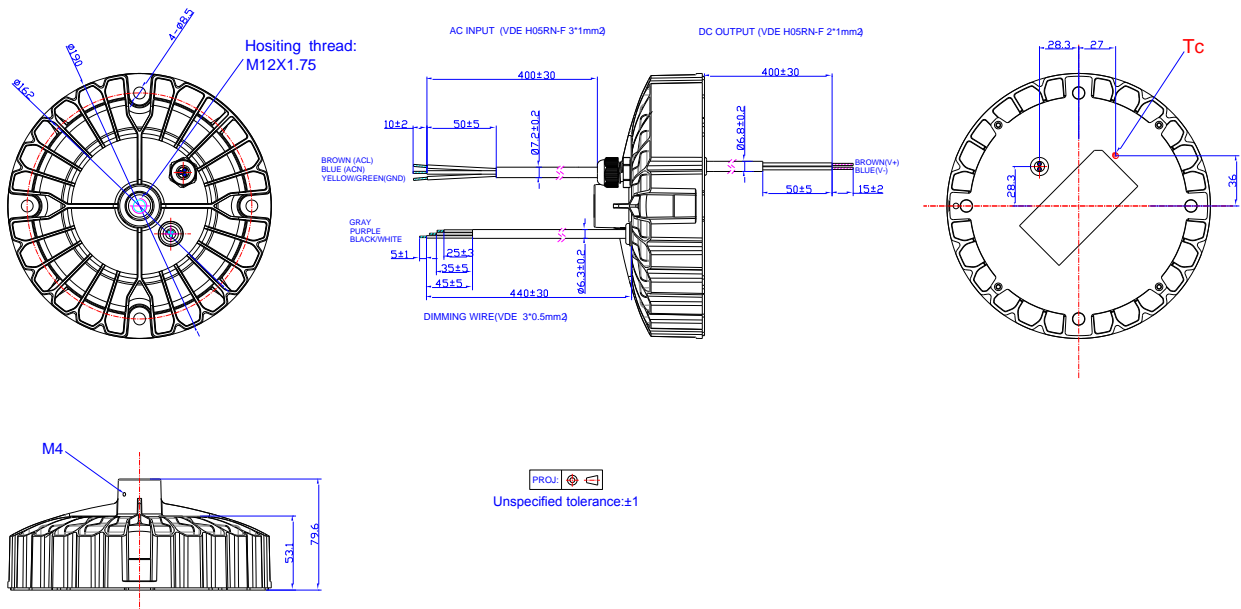



## Revision History

Change Date	Rev.	Description of Change		
		Item	From	To
2016-07-08	A	Datasheets Release	/	/
2016-10-25	B	Features	/	Updated
		Mechanical Outline	/	Updated
2018-03-01	C	Features	5 Years Warranty	Added
		Description	/	Updated
		Models	Notes(2)	Updated
		Input Specifications	PF/THD	Updated
		General Specifications	Case temperature for 5 years warranty	Updated
		Mechanical Outline	Optional Metal Parts	Added