



Bridgelux® Vero® SE 29 Array

Product Data Sheet DS123



Introduction

Vero SE



Vero® SE Series is a revolutionary light source system that integrates Bridgelux's seventh generation COB technology with poke-in connectivity enabling solder-free installation. Vero SE LED light sources streamline assembly processes, lower manufacturing cost, simplify luminaire design, improve light quality and increase design flexibility.

Vero SE is available in four different light emitting surface (LES) configurations that operate reliably over a broad current range. With Vero SE, secondary connector and holder components are not required, allowing for rapid integration of arrays into fixtures and an efficient field replaceable solution. Vero SE arrays deliver increased lumen density for improved beam control and precision lighting with 2 and 3 SDCM color control standards for clean and consistent uniform lighting.

Bridgelux Décor Series is our state of the art color line designed specifically for premium applications, producing unmatched LED light quality with brilliant color-rendering options and offer pleasing and inspiring lighting palettes. Bridgelux Décor Series color points are available on Vero® SE Series, Vero® Series, V Series™ and V Series™ HD.

Décor Series Class A is based on human response testing, providing color points with a combined GAI and CRI metric.

Décor Series™ Ultra products provide a high CRI of 97 and typical R9 value of 98, which emphasizes the reds and color tones to which the human eye is most receptive - perfect for the most luxurious retail shops and world renowned museums. Décor Series Ultra is designed as a replacement for halogen lamps

Décor Series™ Food products offer color points developed to address the unique requirements of the food, grocery, and restaurant industries. Highlighting the distinctive colors and nuanced patterns found in meats and breads, the Décor Series Food products are a must have for any butcher counter or bakery.

Décor Series™ Entertainment products provide color points developed specifically for the healthcare and entertainment industries. The 5600K cool white color point combined with a CRI of 90 or 97 provides the bright white required by these industries.

Décor Series™ Street and Landmark is designed to be a direct replacement for high pressure sodium lamps.

Features

- Poke-in connectivity
- Efficacy of 159 lm/W typical
- Lumen output performance ranges from 5,368 to 37,173 lumens
- Broad range of CCT options from 1750K to 6500K
- CRI options: minimum 65, 70, 80, and 90
- Color control: 2 and 3 SDCM for 2700K-4000K CCT
- Reliable operation at up to 2X nominal drive current
- Radial die pattern and improved lumen density
- Top side part number markings
- No exposed solder pads or electrical connections
- V_r bin code backside marking

Benefits

- Poke-in connectivity enables solderless, connector free installation
- Broad application coverage for interior and exterior lighting
- Flexibility for application driven lighting design requirements
- High quality, true color reproduction
- Uniform consistent white light
- Flexibility in design optimization
- Enhanced ease of use and assembly
- Ability to configure multiple arrays in series and parallel reduces customer driver cost
- Improved inventory management and quality control



Contents

Product Feature Map	2
Product Nomenclature	2
Product Selection Guide	3
Performance at Commonly Used Drive Currents	10
Electrical Characteristics	20
Eye Safety	21
Absolute Maximum Ratings	22
Performance Curves	23
Typical Radiation Pattern	27
Typical Color Spectrum	28
Mechanical Dimensions	29
Color Binning Information	30
Packaging and Labeling	31
Design Resources	33
Precautions	33
Disclaimers	33
About Bridgelux	34

Product Feature Map

Vero SE 29 is the largest form factor in the product family of next generation solid state light sources. In addition to delivering the performance and light quality required for many lighting applications, Vero SE incorporates several

features to simplify the design integration and manufacturing process, accelerate time to market and reduce system costs. Please visit www.bridgelux.com for more information on the Vero SE Series family of products.

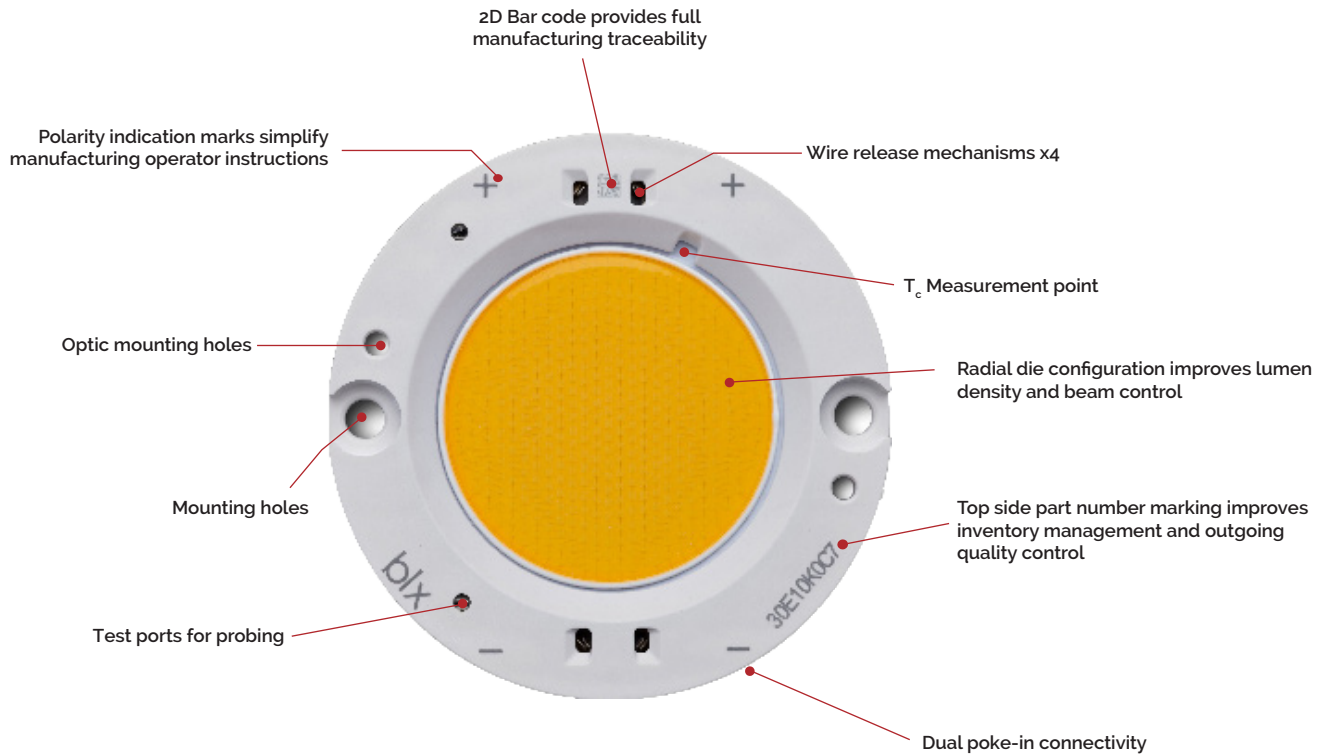

Product Nomenclature

The part number designation for Bridgelux Vero SE LED arrays is explained as follows:

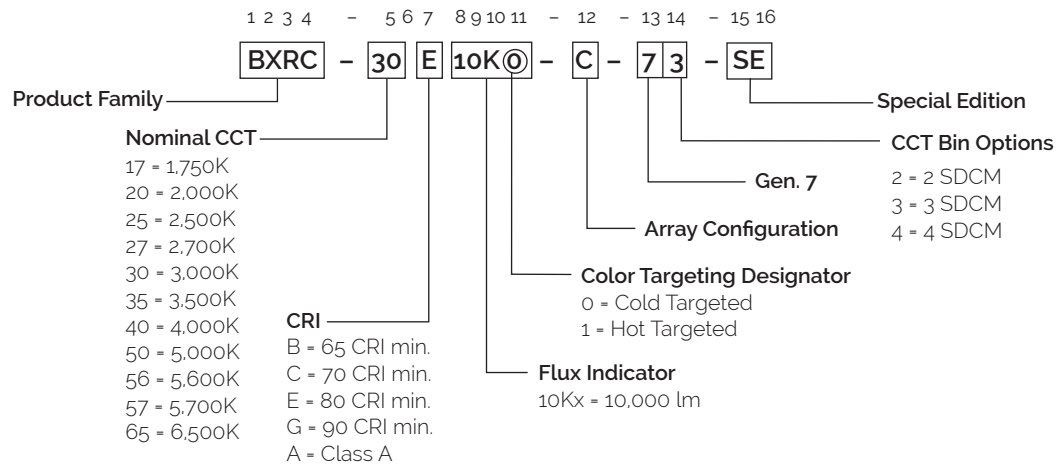

Product Selection Guide

The following product configurations are available:

Table 1: Selection Guide, Pulsed Measurement Data ($T_j = T_c = 25^\circ\text{C}$)

Part Number	Nominal CCT ¹ (K)	CRI ²	Nominal Drive Current ³ (mA)	Typical Pulsed Flux ^{4,5,6} $T_c = 25^\circ\text{C}$ (lm)	Minimum Pulsed Flux ^{6,7} $T_c = 25^\circ\text{C}$ (lm)	Typical V_f (V)	Typical Power (W)	Typical Efficacy (lm/W)
BXRC-17E10K0-B-74-SE	1750	80	1800	8237	7413	52.0	93.6	88
BXRC-17E10K0-C-74-SE	1750	80	1710	10443	9399	69.4	118.7	88
BXRC-17E10K0-D-74-SE	1750	80	2100	6948	6254	37.6	79.0	88
BXRC-20B10K1-C-73-SE	2000	65	1710	17682	15914	69.4	118.7	149
BXRC-20B10K1-D-73-SE	2000	65	2100	11765	10589	37.6	79.0	149
BXRC-25E10K0-B-74-SE	2500	80	1800	13385	12046	52.0	93.6	143
BXRC-25E10K0-C-74-SE	2500	80	1710	16970	15273	69.4	118.7	143
BXRC-25E10K0-D-74-SE	2500	80	2100	11291	10162	37.6	79.0	143
BXRC-27E10K0-B-7x-SE	2700	80	1800	14321	12889	52.0	93.6	153
BXRC-27E10K0-C-7x-SE	2700	80	1710	18157	16341	69.4	118.7	153
BXRC-27E10K0-D-7x-SE	2700	80	2100	12081	10873	37.6	79.0	153
BXRC-27G1KH0-B-7x-SE	2700	90	1800	12355	11120	52.0	93.6	132
BXRC-27G1KH0-C-7x-SE	2700	90	1710	15665	14098	69.4	118.7	132
BXRC-27G1KH0-D-7x-SE	2700	90	2100	10423	9380	37.6	79.0	132
BXRC-27G10K0-B-7x-SE	2700	90	1800	11887	10698	52.0	93.6	127
BXRC-27G10K0-C-7x-SE	2700	90	1710	15072	13564	69.4	118.7	127
BXRC-27G10K0-D-7x-SE	2700	90	2100	10028 ¹⁰	9025	37.6	79.0	127
BXRC-27H10K0-D-74-SE	2700	97	2100	8765	7888	37.6	79.0	111
BXRC-30C10K1-B-74-SE	3000	70	1800	16380	14742	52.0	93.6	175
BXRC-30C10K1-C-74-SE	3000	70	1710	20768	18691	69.4	118.7	175
BXRC-30C10K1-D-74-SE	3000	70	2100	13818	12436	37.6	79.0	175
BXRC-30E10K0-B-7x-SE ¹⁰	3000	80	1800	14882	13394	52.0	93.6	159
BXRC-30E10K0-C-7x-SE ¹⁰	3000	80	1710	18869	16982	69.4	118.7	159
BXRC-30E10K0-D-7x-SE ¹⁰	3000	80	2100	12555	11299	37.6	79.0	159
BXRC-30G1KH0-B-7x-SE	3000	90	1800	12917	11625	52.0	93.6	138
BXRC-30G1KH0-C-7x-SE	3000	90	1710	16377	14739	69.4	118.7	138
BXRC-30G1KH0-D-7x-SE	3000	90	2100	10896	9807	37.6	79.0	138
BXRC-30G10K0-B-7x-SE	3000	90	1800	12449	11204	52.0	93.6	133
BXRC-30G10K0-C-7x-SE	3000	90	1710	15784	14205	69.4	118.7	133
BXRC-30G10K0-D-7x-SE	3000	90	2100	10502	9452	37.6	79.0	133
BXRC-30H10K0-D-7x-SE	3000	97	2100	9317	8386	37.6	79.0	118
BXRC-30A10K1-B-73-SE ^{8,9}	3000	93	1800	11232	10109	52.0	93.6	120
BXRC-30A10K1-C-73-SE ^{8,9}	3000	93	1710	14241	12817	69.4	118.7	120
BXRC-30A10K1-D-73-SE ^{8,9}	3000	93	2100	9475	8528	37.6	79.0	120

Notes for Table 1:

- Nominal CCT as defined by ANSI C78.377-2011. Products with a CCT of 5000K-6500K are hot targeted to $T_c = 85^\circ\text{C}$.
- All CRI values are measured at $T_j = T_c = 25^\circ\text{C}$. CRI values are typical for Decor Series Ultra, Decor Series Street and Landmark and Decor Series Class A products. CRI values are minimums for all other products. Minimum Rg value for 80 CRI products is 0, the minimum Rg values for 90 CRI products is 50, the minimum Rg values for 97 CRI products is 93. Bridgelux maintains a ± 3 tolerance on CRI and Rg values.
- Drive current is referred to as nominal drive current.
- Products tested under pulsed condition (10ms pulse width) at nominal test current where T_j (junction temperature) = T_c (case temperature) = 25°C .
- Typical performance values are provided as a reference only and are not a guarantee of performance.
- Bridgelux maintains a $\pm 7\%$ tolerance on flux measurements.
- Minimum flux values at the nominal test current are guaranteed by 100% test.
- Nominal CCT is defined by the Lighting Research Center's Class A definition. The center of the Class A color bin is on the corresponding isothermal line.
- GAI value is 80. To help ensure optimal fixture level performance, GAI is measured at the fixture level, on axis, at a case temperature of 70°C . GAI may vary depending on fixture design and performance.
- SKUs meet DLC premium (Outdoor Mid Output) requirements under certain system level conditions.

Product Selection Guide

Table 1: Selection Guide, Pulsed Measurement Data ($T_j = T_c = 25^\circ\text{C}$) (continued)

Part Number	Nominal CCT ¹ (K)	CRI ²	Nominal Drive Current ³ (mA)	Typical Pulsed Flux ^{4,5,6} $T_c = 25^\circ\text{C}$ (lm)	Minimum Pulsed Flux ^{6,7} $T_c = 25^\circ\text{C}$ (lm)	Typical V_f (V)	Typical Power (W)	Typical Efficacy (lm/W)
BXRC-35E10K0-B-7x-SE ¹⁰	3500	80	1800	15350	13815	52.0	93.6	164
BXRC-35E10K0-C-7x-SE ¹⁰	3500	80	1710	19463	17516	69.4	118.7	164
BXRC-35E10K0-D-7x-SE ¹⁰	3500	80	2100	12949	11654	37.6	79.0	164
BXRC-35G10K0-B-7x-SE	3500	90	1800	12823	11541	52.0	93.6	137
BXRC-35G10K0-C-7x-SE	3500	90	1710	16258	14633	69.4	118.7	137
BXRC-35G10K0-D-7x-SE	3500	90	2100	10818	9736	37.6	79.0	137
BXRC-35A10K1-B-73-SE ^{8,9}	3500	93	1800	12074	10867	52.0	93.6	129
BXRC-35A10K1-C-73-SE ^{8,9}	3500	93	1710	15309	13778	69.4	118.7	129
BXRC-35A10K1-D-73-SE ^{8,9}	3500	93	2100	10186	9167	37.6	79.0	129
BXRC-40C10K1-B-74-SE	4000	70	1800	16848	15163	52.0	93.6	180
BXRC-40C10K1-C-74-SE	4000	70	1710	21361	19225	69.4	118.7	180
BXRC-40C10K1-D-74-SE	4000	70	2100	14213	12792	37.6	79.0	180
BXRC-40E10K0-B-7x-SE ¹⁰	4000	80	1800	15444	13900	52.0	93.6	165
BXRC-40E10K0-C-7x-SE ¹⁰	4000	80	1710	19581	17623	69.4	118.7	165
BXRC-40E10K0-D-7x-SE ¹⁰	4000	80	2100	13028	11726	37.6	79.0	165
BXRC-40G10K0-B-7x-SE	4000	90	1800	13291	11962	52.0	93.6	142
BXRC-40G10K0-C-7x-SE	4000	90	1710	16852	15167	69.4	118.7	142
BXRC-40G10K0-D-7x-SE	4000	90	2100	11212	10091	37.6	79.0	142
BXRC-40H10K0-D-7x-SE	4000	97	2100	9633	8670	37.6	79.0	122
BXRC-40A10K1-B-73-SE ^{8,9}	4000	93	1800	12917	11625	52.0	93.6	138
BXRC-40A10K1-C-73-SE ^{8,9}	4000	93	1710	16377	14739	69.4	118.7	138
BXRC-40A10K1-D-73-SE ^{8,9}	4000	93	2100	10896	9807	37.6	79.0	138
BXRC-50C10K1-B-7x-SE ¹⁰	5000	70	1800	17035	15332	52.0	93.6	182
BXRC-50C10K1-C-7x-SE ¹⁰	5000	70	1710	21599	19439	69.4	118.7	182
BXRC-50C10K1-D-7x-SE ¹⁰	5000	70	2100	14371	12934	37.6	79.0	182
BXRC-50E10K1-B-7x-SE ¹⁰	5000	80	1800	16006	14405	52.0	93.6	171
BXRC-50E10K1-C-7x-SE ¹⁰	5000	80	1710	20293	18264	69.4	118.7	171
BXRC-50E10K1-D-7x-SE ¹⁰	5000	80	2100	13502	12152	37.6	79.0	171
BXRC-50G10K1-B-7x-SE	5000	90	1800	13572	12215	52.0	93.6	145
BXRC-50G10K1-C-74-SE	5000	90	1710	17208	15487	69.4	118.7	145
BXRC-50G10K1-D-74-SE	5000	90	2100	11449	10304	37.6	79.0	145
BXRC-56G10K0-B-74-SE	5600	80	1800	14227	12804	52.0	93.6	152

Notes for Table 1:

- Nominal CCT as defined by ANSI C78.377-2011. Products with a CCT of 5000K-6500K are hot targeted to $T_c = 85^\circ\text{C}$.
- All CRI values are measured at $T_j = T_c = 25^\circ\text{C}$. CRI values are typical for Decor Series Ultra, Decor Series Street and Landmark and Decor Series Class A products. CRI values are minimums for all other products. Minimum Rg value for 80 CRI products is 0, the minimum Rg values for 90 CRI products is 50, the minimum Rg values for 97 CRI products is 93. Bridgelux maintains a ± 3 tolerance on CRI and Rg values.
- Drive current is referred to as nominal drive current.
- Products tested under pulsed condition (10ms pulse width) at nominal test current where T_j (junction temperature) - T_c (case temperature) = 25°C .
- Typical performance values are provided as a reference only and are not a guarantee of performance.
- Bridgelux maintains a $\pm 7\%$ tolerance on flux measurements.
- Minimum flux values at the nominal test current are guaranteed by 100% test.
- Nominal CCT is defined by the Lighting Research Center's Class A definition. The center of the Class A color bin is on the corresponding isothermal line.
- GAI value is 80. To help ensure optimal fixture level performance, GAI is measured at the fixture level, on axis, at a case temperature of 70°C . GAI may vary depending on fixture design and performance.
- SKUs meet DLC premium (Outdoor Mid Output) requirements under certain system level conditions.

Product Selection Guide

Table 1: Selection Guide, Pulsed Measurement Data ($T_j = T_c = 25^\circ\text{C}$) (continued)

Part Number	Nominal CCT ¹ (K)	CRI ²	Nominal Drive Current ³ (mA)	Typical Pulsed Flux ^{4,5,6} $T_c = 25^\circ\text{C}$ (lm)	Minimum Pulsed Flux ^{6,7} $T_c = 25^\circ\text{C}$ (lm)	Typical V_f (V)	Typical Power (W)	Typical Efficacy (lm/W)
BXRC-50G10K1-C-7x-SE	5600	80	1710	18038	16235	69.4	118.7	152
BXRC-50G10K1-D-7x-SE	5600	80	2100	12002	10802	37.6	79.0	152
BXRC-56G10K1-B-74-SE	5600	97	2100	10423	9380	37.6	79.0	132
BXRC-56G10K1-C-74-SE	5700	70	1800	16474	14826	52.0	93.6	176
BXRC-56G10Kx-D-74-SE	5700	70	1710	20887	18798	69.4	118.7	176
BXRC-56H10K0-D-74-SE	5700	70	2100	13897	12507	37.6	79.0	176
BXRC-57C10K1-B-7x-SE ¹⁰	5700	80	1800	15818	14237	52.0	93.6	169
BXRC-57C10K1-C-7x-SE ¹⁰	5700	80	1710	20056	18050	69.4	118.7	169
BXRC-57C10K1-D-7x-SE ¹⁰	5700	80	2100	13344	12010	37.6	79.0	169
BXRC-57E10K1-B-7x-SE ¹⁰	6500	70	1800	16754	15079	52.0	93.6	179
BXRC-57E10K1-C-7x-SE ¹⁰	6500	70	1710	21243	19118	69.4	118.7	179
BXRC-57E10K1-D-7x-SE ¹⁰	6500	70	2100	14134	12720	37.6	79.0	179
BXRC-65C10K1-B-7x-SE ¹⁰	6500	80	1800	16099	14489	52.0	93.6	172
BXRC-65C10K1-C-7x-SE ¹⁰	6500	80	1710	20412	18371	69.4	118.7	172
BXRC-65C10K1-D-7x-SE ¹⁰	6500	80	2100	13581	12223	37.6	79.0	172

Notes for Table 1:

- Nominal CCT as defined by ANSI C78.377-2011. Products with a CCT of 5000K-6500K are hot targeted to $T_c = 85^\circ\text{C}$.
- All CRI values are measured at $T_j = T_c = 25^\circ\text{C}$. CRI values are typical for Decor Series Ultra, Decor Series Street and Landmark and Decor Series Class A products. CRI values are minimums for all other products. Minimum Rg value for 80 CRI products is 0, the minimum Rg values for 90 CRI products is 50, the minimum Rg values for 97 CRI products is 93. Bridgelux maintains a ± 3 tolerance on CRI and Rg values.
- Drive current is referred to as nominal drive current.
- Products tested under pulsed condition (10ms pulse width) at nominal test current where T_j (junction temperature) = T_c (case temperature) = 25°C .
- Typical performance values are provided as a reference only and are not a guarantee of performance.
- Bridgelux maintains a $\pm 7\%$ tolerance on flux measurements.
- Minimum flux values at the nominal test current are guaranteed by 100% test.
- Nominal CCT is defined by the Lighting Research Center's Class A definition. The center of the Class A color bin is on the corresponding isothermal line.
- GAI value is 80. To help ensure optimal fixture level performance, GAI is measured at the fixture level, on axis, at a case temperature of 70°C . GAI may vary depending on fixture design and performance.
- SKUs meet DLC premium (Outdoor Mid Output) requirements under certain system level conditions.

Product Selection Guide

Table 2: Selection Guide, Stabilized DC Performance ($T_c = 70^\circ\text{C}$) ^{7,8}

Part Number	Nominal CCT ¹ (K)	GAI ²	CRI ³	Nominal Drive Current ⁴ (mA)	Typical DC Flux ^{5,6} $T_c = 70^\circ\text{C}$ (lm)	Minimum DC Flux ^{6,9} $T_c = 70^\circ\text{C}$ (lm)	Typical V_f (V)	Typical Power (W)	Typical Efficacy (lm/W)
BXRC-30A10K1-B-73-SE	3000	80	93	1800	10446	9401	50.9	91.6	114
BXRC-30A10K1-C-73-SE	3000	80	93	1710	13244	11920	67.9	116.1	114
BXRC-30A10K1-D-73-SE	3000	80	93	2100	8812	7931	36.8	77.3	114
BXRC-35A10K1-B-73-SE	3500	80	93	1800	11229	10106	50.9	91.6	123
BXRC-35A10K1-C-73-SE	3500	80	93	1710	14237	12814	67.9	116.1	123
BXRC-35A10K1-D-73-SE	3500	80	93	2100	9473	8526	36.8	77.3	123
BXRC-40A10K1-B-73-SE	4000	80	93	1800	12013	10811	50.9	91.6	131
BXRC-40A10K1-C-73-SE	4000	80	93	1710	15231	13708	67.9	116.1	131
BXRC-40A10K1-D-73-SE	4000	80	93	2100	10134	9120	36.8	77.3	131

Notes for Table 2:

- Nominal CCT is defined by the Lighting Research Center's Class A definition. The center of the Class A color bin is on the corresponding isothermal line.
- To help ensure optimal fixture level performance, GAI is measured at the fixture level, on axis, at a case temperature of 70°C . GAI may vary depending on fixture design and performance.
- CRI Values are specified as typical.
- Drive current is referred to as nominal drive current.
- Typical performance values are provided as a reference only and are not a guarantee of performance.
- Bridgelux maintains a $\pm 7\%$ tolerance on flux measurements.
- Typical stabilized DC performance values are provided as reference only and are not a guarantee of performance.
- Typical performance is estimated based on operation under DC (direct current) with LED array mounted onto a heat sink with thermal interface material and the case temperature maintained at specified temperature. Based on Bridgelux test setup, values may vary depending on the thermal design of the luminaire and/or the exposed environment to which the product is subjected.
- Minimum flux values at elevated temperatures are provided for reference only and are not guaranteed by 100% production testing. Based on Bridgelux test setup, values may vary depending on the thermal design of the luminaire and/or the exposed environment to which the product is subjected.

Product Selection Guide

Table 3: Selection Guide, Stabilized DC Performance ($T_c = 85^\circ\text{C}$)^{4,5}

Part Number	Nominal CCT ¹ (K)	CRI ²	Nominal Drive Current ³ (mA)	Typical DC Flux ^{4,5} $T_c = 85^\circ\text{C}$ (lm)	Minimum DC Flux ⁶ $T_c = 85^\circ\text{C}$ (lm)	Typical V_f (V)	Typical Power (W)	Typical Efficacy (lm/W)
BXRC-17E10K0-B-74-SE	1750	80	1800	7413	6672	50.7	91.2	81
BXRC-17E10K0-C-74-SE	1750	80	1710	9399	8459	68.1	116.4	81
BXRC-17E10K0-D-74-SE	1750	80	2100	6254	5628	36.6	76.8	81
BXRC-20B10K1-C-73-SE	2000	65	1710	15914	14323	68.1	116.4	137
BXRC-20B10K1-D-73-SE	2000	65	2100	10589	9530	36.6	76.8	138
BXRC-25E10K0-B-74-SE	2500	80	1800	12046	10842	50.7	91.2	132
BXRC-25E10K0-C-74-SE	2500	80	1710	15273	13746	68.1	116.4	131
BXRC-25E10K0-D-74-SE	2500	80	2100	10162	9146	36.6	76.8	132
BXRC-27E10K0-B-7X-SE	2700	80	1800	12889	11600	50.7	91.2	141
BXRC-27E10K0-C-7X-SE	2700	80	1710	16341	14707	68.1	116.4	140
BXRC-27E10K0-D-7X-SE	2700	80	2100	10873	9786	36.6	76.8	142
BXRC-27G1KH0-B-7X-SE	2700	90	1800	11120	10008	50.7	91.2	122
BXRC-27G1KH0-C-7X-SE	2700	90	1710	14098	12689	68.1	116.4	121
BXRC-27G1KH0-D-7X-SE	2700	90	2100	9380	8442	36.6	76.8	122
BXRC-27G10K0-B-7X-SE	2700	90	1800	10698	9629	50.7	91.2	117
BXRC-27G10K0-C-7X-SE	2700	90	1710	13564	12208	68.1	116.4	117
BXRC-27G10K0-D-7X-SE	2700	90	2100	9025	8123	36.6	76.8	118
BXRC-27H10K0-D-74-SE	2700	97	2100	7888	7099	36.6	76.9	103
BXRC-30C10K1-B-74-SE	3000	70	1800	14742	13268	50.7	91.2	162
BXRC-30C10K1-C-74-SE	3000	70	1710	18691	16822	68.1	116.4	161
BXRC-30C10K1-D-74-SE	3000	70	2100	12436	11193	36.6	76.8	162
BXRC-30E10K0-B-7X-SE	3000	80	1800	13394	12055	50.7	91.2	147
BXRC-30E10K0-C-7X-SE	3000	80	1710	16982	15284	68.1	116.4	146
BXRC-30E10K0-D-7X-SE	3000	80	2100	11299	10169	36.6	76.8	147
BXRC-30G1KH0-B-7X-SE	3000	90	1800	11625	10463	50.7	91.2	127
BXRC-30G1KH0-C-7X-SE	3000	90	1710	14739	13265	68.1	116.4	127
BXRC-30G1KH0-D-7X-SE	3000	90	2100	9807	8826	36.6	76.8	128
BXRC-30G10K0-B-7X-SE	3000	90	1800	11204	10084	50.7	91.2	123
BXRC-30G10K0-C-7X-SE	3000	90	1710	14205	12785	68.1	116.4	122
BXRC-30G10K0-D-7X-SE	3000	90	2100	9452	8506	36.6	76.8	123
BXRC-30H10K0-D-7X-SE	3000	97	2100	8386	7547	36.6	76.8	109
BXRC-30A10K1-B-73-SE ^{7,8}	3000	93	1800	10109	9098	50.7	91.2	111
BXRC-30A10K1-C-73-SE ^{7,8}	3000	93	1710	12817	11535	68.1	116.4	110
BXRC-30A10K1-D-73-SE ^{7,8}	3000	93	2100	8528	7675	36.6	76.8	111

Notes for Table 3:

- Nominal CCT as defined by ANSI C78 377-2011. Products with a CCT of 5000K-6500K are hot targeted to $T_c = 85^\circ\text{C}$.
- All CRI values are measured at $T_c = 25^\circ\text{C}$. CRI values are typical for Decor Series Ultra, Decor Series Street and Landmark and Decor Series Class A products. CRI values are minimums for all other products. Minimum Rg value for 80 CRI products is 0, the minimum Rg values for 90 CRI products is 50, the minimum Rg values for 97 CRI products is 93. Bridgelux maintains a ± 3 tolerance on CRI and Rg values.
- Drive current is referred to as nominal drive current.
- Typical stabilized DC performance values are provided as reference only and are not a guarantee of performance.
- Typical performance is estimated based on operation under DC (direct current) with LED array mounted onto a heat sink with thermal interface material and the case temperature maintained at 85°C . Based on Bridgelux test setup, values may vary depending on the thermal design of the luminaire and/or the exposed environment to which the product is subjected.
- Minimum flux values at elevated temperatures are provided for reference only and are not guaranteed by 100% production testing. Based on Bridgelux test setup, values may vary depending on the thermal design of the luminaire and/or the exposed environment to which the product is subjected.
- Nominal CCT is defined by the Lighting Research Center's Class A definition. The center of the Class A color bin is on the corresponding isothermal line.
- GAI value is 80. To help ensure optimal fixture level performance, GAI is measured at the fixture level, on axis, at a case temperature of 70°C . GAI may vary depending on fixture design and performance.

Product Selection Guide

Table 3: Selection Guide, Stabilized DC Performance ($T_c = 85^\circ\text{C}$)^{4,5} (continued)

Part Number	Nominal CCT ¹ (K)	CRI ²	Nominal Drive Current ³ (mA)	Typical DC Flux ^{4,5} $T_c = 85^\circ\text{C}$ (lm)	Minimum DC Flux ⁶ $T_c = 85^\circ\text{C}$ (lm)	Typical V_f (V)	Typical Power (W)	Typical Efficacy (lm/W)
BXRC-35E10K0-B-7x-SE	3500	80	1800	13815	12434	50.7	91.2	151
BXRC-35E10K0-C-7x-SE	3500	80	1710	17516	15765	68.1	116.4	150
BXRC-35E10K0-D-7x-SE	3500	80	2100	11654	10489	36.6	76.8	152
BXRC-35G10K0-B-7x-SE	3500	90	1800	11541	10387	50.7	91.2	127
BXRC-35G10K0-C-7x-SE	3500	90	1710	14633	13169	68.1	116.4	126
BXRC-35G10K0-D-7x-SE	3500	90	2100	9736	8762	36.6	76.8	127
BXRC-35A10K1-B-73-SE ^{7,8}	3500	93	1800	10867	9780	50.7	91.2	119
BXRC-35A10K1-C-73-SE ^{7,8}	3500	93	1710	13778	12400	68.1	116.4	118
BXRC-35A10K1-D-73-SE ^{7,8}	3500	93	2100	9167	8251	36.6	76.8	119
BXRC-40C10K1-B-74-SE	4000	70	1800	15163	13647	50.7	91.2	166
BXRC-40C10K1-C-74-SE	4000	70	1710	19225	17303	68.1	116.4	165
BXRC-40C10K1-D-74-SE	4000	70	2100	12792	11512	36.6	76.8	167
BXRC-40E10K0-B-7x-SE	4000	80	1800	13900	12510	50.7	91.2	152
BXRC-40E10K0-C-7x-SE	4000	80	1710	17623	15861	68.1	116.4	151
BXRC-40E10K0-D-7x-SE	4000	80	2100	11726	10553	36.6	76.8	153
BXRC-40G10K0-B-7x-SE	4000	90	1800	11962	10766	50.7	91.2	131
BXRC-40G10K0-C-7x-SE	4000	90	1710	15167	13650	68.1	116.4	130
BXRC-40G10K0-D-7x-SE	4000	90	2100	10091	9082	36.6	76.8	131
BXRC-40H10K0-D-7x-SE	4000	97	2100	8670	7803	36.6	76.8	113
BXRC-40A10K1-B-73-SE ^{7,8}	4000	93	1800	11625	10463	50.7	91.2	127
BXRC-40A10K1-C-73-SE ^{7,8}	4000	93	1710	14739	13265	68.1	116.4	127
BXRC-40A10K1-D-73-SE ^{7,8}	4000	93	2100	9807	8826	36.6	76.8	128
BXRC-50C10K1-B-7x-SE	5000	70	1800	15332	13799	50.7	91.2	168
BXRC-50C10K1-C-7x-SE	5000	70	1710	19439	17495	68.1	116.4	167
BXRC-50C10K1-D-7x-SE	5000	70	2100	12934	11640	36.6	76.8	168
BXRC-50E10K1-B-7x-SE	5000	80	1800	14405	12965	50.7	91.2	158
BXRC-50E10K1-C-7x-SE	5000	80	1710	18264	16438	68.1	116.4	157
BXRC-50E10K1-D-7x-SE	5000	80	2100	12152	10937	36.6	76.8	158
BXRC-50G10K1-B-7x-SE	5000	90	1800	12215	10993	50.7	91.2	134
BXRC-50G10K1-C-7x-SE	5000	90	1710	15487	13938	68.1	116.4	133
BXRC-50G10K1-D-7x-SE	5000	90	2100	10304	9274	36.6	76.8	134
BXRC-56G10K1-B-74-SE	5600	80	1800	12804	11524	50.7	91.2	140
BXRC-56G10K1-C-74-SE	5600	80	1710	16235	14611	68.1	116.4	139
BXRC-56G10Kx-D-74-SE	5600	80	2100	10802	9722	36.6	76.8	141
BXRC-56H10K0-D-74-SE	5600	97	2100	9380	8442	36.6	76.8	122

Notes for Table 3:

- Nominal CCT as defined by ANSI C78.377-2011. Products with a CCT of 5000K-6500K are hot targeted to $T_c = 85^\circ\text{C}$.
- All CRI values are measured at $T_1 - T_c = 25^\circ\text{C}$. CRI values are typical for Decor Series Ultra, Decor Series Street and Landmark and Decor Series Class A products. CRI values are minimums for all other products. Minimum Rg value for 80 CRI products is 0, the minimum Rg values for 90 CRI products is 50, the minimum Rg values for 97 CRI products is 93. Bridgelux maintains a ± 3 tolerance on CRI and Rg values.
- Drive current is referred to as nominal drive current.
- Typical stabilized DC performance values are provided as reference only and are not a guarantee of performance.
- Typical performance is estimated based on operation under DC (direct current) with LED array mounted onto a heat sink with thermal interface material and the case temperature maintained at 85°C . Based on Bridgelux test setup, values may vary depending on the thermal design of the luminaire and/or the exposed environment to which the product is subjected.
- Minimum flux values at elevated temperatures are provided for reference only and are not guaranteed by 100% production testing. Based on Bridgelux test setup, values may vary depending on the thermal design of the luminaire and/or the exposed environment to which the product is subjected.
- Nominal CCT is defined by the Lighting Research Center's Class A definition. The center of the Class A color bin is on the corresponding isothermal line.
- GAI value is 80. To help ensure optimal fixture level performance, GAI is measured at the fixture level, on axis, at a case temperature of 70°C . GAI may vary depending on fixture design and performance.

Product Selection Guide

Table 3: Selection Guide, Stabilized DC Performance ($T_c = 85^\circ\text{C}$)^{4,5} (continued)

Part Number	Nominal CCT ¹ (K)	CRI ²	Nominal Drive Current ³ (mA)	Typical DC Flux ^{4,5} $T_c = 85^\circ\text{C}$ (lm)	Minimum DC Flux ⁶ $T_c = 85^\circ\text{C}$ (lm)	Typical V_f (V)	Typical Power (W)	Typical Efficacy (lm/W)
BXRC-57C10K1-B-7x-SE	5700	70	1800	14826	13344	50.7	91.2	163
BXRC-57C10K1-C-7x-SE	5700	70	1710	18798	16918	68.1	116.4	161
BXRC-57C10K1-D-7x-SE	5700	70	2100	12507	11257	36.6	76.8	163
BXRC-57E10K1-B-7x-SE	5700	80	1800	14237	12813	50.7	91.2	156
BXRC-57E10K1-C-7x-SE	5700	80	1710	18050	16245	68.1	116.4	155
BXRC-57E10K1-D-7x-SE	5700	80	2100	12010	10809	36.6	76.8	156
BXRC-65C10K1-B-7x-SE	6500	70	1800	15079	13571	50.7	91.2	165
BXRC-65C10K1-C-7x-SE	6500	70	1710	19118	17207	68.1	116.4	164
BXRC-65C10K1-D-7x-SE	6500	70	2100	12720	11448	36.6	76.8	166
BXRC-65E10K1-B-7x-SE	6500	80	1800	14489	13040	50.7	91.2	159
BXRC-65E10K1-C-7x-SE	6500	80	1710	18371	16534	68.1	116.4	158
BXRC-65E10K1-D-7x-SE	6500	80	2100	12223	11001	36.6	76.8	159

Notes for Table 3:

- Nominal CCT as defined by ANSI C78.377-2011. Products with a CCT of 5000K-6500K are hot targeted to $T_c = 85^\circ\text{C}$.
- All CRI values are measured at $T_s = T_c = 25^\circ\text{C}$. CRI values are typical for Decor Series Ultra, Decor Series Street and Landmark and Decor Series Class A products. CRI values are minimums for all other products. Minimum R_g value for 80 CRI products is 0, the minimum R_g values for 90 CRI products is 50, the minimum R_g values for 97 CRI products is 93. Bridgelux maintains a ± 3 tolerance on CRI and R_g values.
- Drive current is referred to as nominal drive current.
- Typical stabilized DC performance values are provided as reference only and are not a guarantee of performance.
- Typical performance is estimated based on operation under DC (direct current) with LED array mounted onto a heat sink with thermal interface material and the case temperature maintained at 85°C . Based on Bridgelux test setup, values may vary depending on the thermal design of the luminaire and/or the exposed environment to which the product is subjected.
- Minimum flux values at elevated temperatures are provided for reference only and are not guaranteed by 100% production testing. Based on Bridgelux test setup, values may vary depending on the thermal design of the luminaire and/or the exposed environment to which the product is subjected.
- Nominal CCT is defined by the Lighting Research Center's Class A definition. The center of the Class A color bin is on the corresponding isothermal line.
- GAI value is 80. To help ensure optimal fixture level performance, GAI is measured at the fixture level, on axis, at a case temperature of 70°C . GAI may vary depending on fixture design and performance.

Performance at Commonly Used Drive Currents

Vero SE LED arrays are tested to the specifications shown using the nominal drive currents in Table 1. Vero SE may also be driven at other drive currents dependent on specific application design requirements. The performance at any drive current can be derived from the current vs. voltage characteristics shown in Figures 1, 2 & 3 and the flux vs. current characteristics shown in Figures 4, 5 & 6. The performance at commonly used drive currents is summarized in Table 4.

Table 4: Product Performance at Commonly Used Drive Currents

Part Number	CRI	Drive Current ¹ (mA)	Typical V _f T _c = 25°C (V)	Typical Power T _c = 25°C (W)	Typical Flux ² T _c = 25°C (lm)	Typical DC Flux ³ T _c = 85°C (lm)	Typical Efficacy T _c = 25°C (lm/W)
BXRC-17E10K0-B-74-SE	80	900	49.6	44.7	4276	3903	96
		1200	50.5	60.6	5630	5118	93
		1800	52.0	93.6	8237	7413	88
		2700	54.1	146.1	11873	10589	81
		3600	55.8	201.0	15196	13389	76
BXRC-17E10K0-C-74-SE	80	855	66.2	56.6	5933	5645	105
		1140	67.3	76.7	7540	6955	98
		1710	69.4	118.7	10443	9399	88
		2565	72.1	185.0	14815	12742	80
		3420	74.4	254.6	18569	15603	73
BXRC-17E10K0-D-74-SE	80	1050	35.4	37.2	3822	3724	103
		1400	36.2	50.6	4919	4578	97
		2100	37.6	79.0	6948	6254	88
		3150	39.5	124.4	9892	8335	80
		4200	41.2	172.9	12468	10181	72
BXRC-20B10K1-C-73-SE	65	855	66.2	56.6	10045	9559	178
		1140	67.3	76.7	12767	11777	166
		1710	69.4	118.7	17682	15914	149
		2565	72.1	185.0	25085	21575	136
		3420	74.4	254.6	31441	26419	124
BXRC-20B10K1-D-73-SE	65	1050	35.4	37.2	6471	6305	174
		1400	36.2	50.6	8328	7751	164
		2100	37.6	79.0	11765	10589	149
		3150	39.5	124.4	16749	14113	135
		4200	41.2	172.9	21110	17238	122
BXRC-25E10K0-B-74-SE	80	900	49.6	44.7	6948	6343	156
		1200	50.5	60.6	9149	8317	151
		1800	52.0	93.6	13385	12046	143
		2700	54.1	146.1	19294	17207	132
		3600	55.8	201.0	24694	21757	123
BXRC-25E10K0-C-74-SE	80	855	66.2	56.6	9640	9174	170
		1140	67.3	76.7	12253	11302	160
		1710	69.4	118.7	16970	15273	143
		2565	72.1	185.0	24075	20706	130
		3420	74.4	254.6	30175	25356	119
BXRC-25E10K0-D-74-SE	80	1050	35.4	37.2	6211	6052	167
		1400	36.2	50.6	7993	7439	158
		2100	37.6	79.0	11291	10162	143
		3150	39.5	124.4	16075	13544	129
		4200	41.2	172.9	20260	16544	117

Notes for Table 4:

1. Alternate drive currents are provided for reference only and are not a guarantee of performance.
2. Bridgelux maintains a ± 7% tolerance on flux measurements.
3. Typical stabilized DC performance values are provided as reference only and are not a guarantee of performance.

Performance at Commonly Used Drive Currents

Table 4: Product Performance at Commonly Used Drive Currents (Continued)

Part Number	CRI	Drive Current ¹ (mA)	Typical V _f T _c = 25°C (V)	Typical Power T _c = 25°C (W)	Typical Flux ² T _c = 25°C (lm)	Typical DC Flux ³ T _c = 85°C (lm)	Typical Efficacy T _c = 25°C (lm/W)
BXRC-27E10K0-B-7x-SE	80	900	49.6	44.7	7434	6786	166
		1200	50.5	60.6	9789	8898	162
		1800	52.0	93.6	14321	12889	153
		2700	54.1	146.1	20643	18410	141
		3600	55.8	201.0	26421	23279	131
BXRC-27E10K0-C-7x-SE	80	855	66.2	56.6	10315	9815	182
		1140	67.3	76.7	13110	12093	171
		1710	69.4	118.7	18157	16341	153
		2565	72.1	185.0	25758	22154	139
		3420	74.4	254.6	32285	27129	127
BXRC-27E10K0-D-7x-SE	80	1050	35.4	37.2	6645	6475	179
		1400	36.2	50.6	8552	7959	169
		2100	37.6	79.0	12081	10873	153
		3150	39.5	124.4	17199	14492	138
		4200	41.2	172.9	21677	17701	125
BXRC-27G1KH0-B-7x-SE	90	900	49.6	44.7	6414	5855	144
		1200	50.5	60.6	8445	7677	139
		1800	52.0	93.6	12355	11120	132
		2700	54.1	146.1	17810	15883	122
		3600	55.8	201.0	22795	20084	113
BXRC-27G1KH0-C-7x-SE	90	855	66.2	56.6	8899	8468	157
		1140	67.3	76.7	11310	10433	147
		1710	69.4	118.7	15665	14098	132
		2565	72.1	185.0	22223	19113	120
		3420	74.4	254.6	27854	23405	109
BXRC-27G1KH0-D-7x-SE	90	1050	35.4	37.2	5733	5586	154
		1400	36.2	50.6	7378	6866	146
		2100	37.6	79.0	10423	9380	132
		3150	39.5	124.4	14838	12503	119
		4200	41.2	172.9	18701	15271	108
BXRC-27G10K0-B-7x-SE	90	900	49.6	44.7	6171	5633	138
		1200	50.5	60.6	8125	7386	134
		1800	52.0	93.6	11887	10698	127
		2700	54.1	146.1	17135	15281	117
		3600	55.8	201.0	21931	19323	109
BXRC-27G10K0-C-7x-SE	90	855	66.2	56.6	8562	8147	151
		1140	67.3	76.7	10882	10038	142
		1710	69.4	118.7	15072	13564	127
		2565	72.1	185.0	21381	18389	116
		3420	74.4	254.6	26799	22519	105
BXRC-27G10K0-D-7x-SE	90	1050	35.4	37.2	5516	5374	148
		1400	36.2	50.6	7099	6606	140
		2100	37.6	79.0	10028	9025	127
		3150	39.5	124.4	14276	12029	115
		4200	41.2	172.9	17993	14693	104

Notes for Table 4:

1. Alternate drive currents are provided for reference only and are not a guarantee of performance.
2. Bridgelux maintains a ± 7% tolerance on flux measurements.
3. Typical stabilized DC performance values are provided as reference only and are not a guarantee of performance.

Performance at Commonly Used Drive Currents

Table 4: Product Performance at Commonly Used Drive Currents (Continued)

Part Number	CRI	Drive Current ¹ (mA)	Typical V _f T _c = 25°C (V)	Typical Power T _c = 25°C (W)	Typical Flux ² T _c = 25°C (lm)	Typical DC Flux ³ T _c = 85°C (lm)	Typical Efficacy T _c = 25°C (lm/W)
BXRC-27H10K0-D-74-SE	97	1050	35.4	37.2	4821	4697	130
		1400	36.2	50.6	6204	5774	123
		2100	37.6	79.0	8765	7888	111
		3150	39.5	124.4	12478	10514	100
		4200	41.2	172.9	15726	12842	91
BXRC-30C10K1-B-74-SE	70	900	49.6	44.7	9305	8855	208
		1200	50.5	60.6	11827	10909	195
		1800	52.0	93.6	16380	14742	175
		2700	54.1	146.1	23237	19986	159
		3600	55.8	201.0	29125	24473	145
BXRC-30C10K1-C-74-SE	70	855	66.2	56.6	11423	11131	202
		1140	67.3	76.7	14702	13682	192
		1710	69.4	118.7	20768	18691	175
		2565	72.1	185.0	29566	24912	160
		3420	74.4	254.6	37264	30429	146
BXRC-30C10K1-D-74-SE	70	1050	35.4	37.2	7601	7406	204
		1400	36.2	50.6	9782	9103	193
		2100	37.6	79.0	13818	12436	175
		3150	39.5	124.4	19672	16575	158
		4200	41.2	172.9	24794	20246	143
BXRC-30E10K0-B-7x-SE	80	900	49.6	44.7	7726	7052	173
		1200	50.5	60.6	10173	9247	168
		1800	52.0	93.6	14882	13394	159
		2700	54.1	146.1	21453	19132	147
		3600	55.8	201.0	27457	24192	137
BXRC-30E10K0-C-7x-SE	80	855	66.2	56.6	10719	10200	189
		1140	67.3	76.7	13624	12567	178
		1710	69.4	118.7	18869	16982	159
		2565	72.1	185.0	26768	23023	145
		3420	74.4	254.6	33551	28193	132
BXRC-30E10K0-D-7x-SE	80	1050	35.4	37.2	6906	6729	186
		1400	36.2	50.6	8887	8271	176
		2100	37.6	79.0	12555	11299	159
		3150	39.5	124.4	17873	15060	144
		4200	41.2	172.9	22527	18395	130
BXRC-30G1KH0-B-7x-SE	90	900	49.6	44.7	6705	6121	150
		1200	50.5	60.6	8829	8026	146
		1800	52.0	93.6	12917	11625	138
		2700	54.1	146.1	18619	16605	127
		3600	55.8	201.0	23831	20997	119
BXRC-30G1KH0-C-7x-SE	90	855	66.2	56.6	9303	8853	164
		1140	67.3	76.7	11824	10907	154
		1710	69.4	118.7	16377	14739	138
		2565	72.1	185.0	23233	19982	126
		3420	74.4	254.6	29120	24469	114

Notes for Table 4:

1. Alternate drive currents are provided for reference only and are not a guarantee of performance.
2. Bridgelux maintains a ± 7% tolerance on flux measurements.
3. Typical stabilized DC performance values are provided as reference only and are not a guarantee of performance.

Performance at Commonly Used Drive Currents

Table 4: Product Performance at Commonly Used Drive Currents (Continued)

Part Number	CRI	Drive Current ¹ (mA)	Typical V _f T _c = 25°C (V)	Typical Power T _c = 25°C (W)	Typical Flux ² T _c = 25°C (lm)	Typical DC Flux ³ T _c = 85°C (lm)	Typical Efficacy T _c = 25°C (lm/W)
BXRC-30G1KH0-D-7x-SE	90	1050	35.4	37.2	5994	5840	161
		1400	36.2	50.6	7714	7179	152
		2100	37.6	79.0	10896	9807	138
		3150	39.5	124.4	15513	13071	125
		4200	41.2	172.9	19552	15966	113
BXRC-30G10K0-B-7x-SE	90	900	49.6	44.7	6462	5899	145
		1200	50.5	60.6	8509	7735	141
		1800	52.0	93.6	12449	11204	133
		2700	54.1	146.1	17945	16003	123
		3600	55.8	201.0	22967	20236	114
BXRC-30G10K0-C-7x-SE	90	855	66.2	56.6	8966	8532	158
		1140	67.3	76.7	11396	10512	149
		1710	69.4	118.7	15784	14205	133
		2565	72.1	185.0	22391	19258	121
		3420	74.4	254.6	28065	23582	110
BXRC-30G10K0-D-7x-SE	90	1050	35.4	37.2	5776	5628	155
		1400	36.2	50.6	7434	6919	147
		2100	37.6	79.0	10502	9452	133
		3150	39.5	124.4	14951	12597	120
		4200	41.2	172.9	18843	15387	109
BXRC-30H10K0-D-7x-SE	97	1050	35.4	37.2	5125	4994	138
		1400	36.2	50.6	6596	6138	130
		2100	37.6	79.0	9317	8386	118
		3150	39.5	124.4	13265	11177	107
		4200	41.2	172.9	16718	13652	97
BXRC-30A10K1-B-73-SE	93	900	49.6	44.7	5831	5322	131
		1200	50.5	60.6	7678	6979	127
		1800	52.0	93.6	11232	10109	120
		2700	54.1	146.1	16191	14439	111
		3600	55.8	201.0	20722	18258	103
BXRC-30A10K1-C-73-SE	93	855	66.2	56.6	8090	7698	143
		1140	67.3	76.7	10282	9485	134
		1710	69.4	118.7	14241	12817	120
		2565	72.1	185.0	20202	17376	109
		3420	74.4	254.6	25322	21277	99
BXRC-30A10K1-D-73-SE	93	1050	35.4	37.2	5212	5078	140
		1400	36.2	50.6	6707	6242	132
		2100	37.6	79.0	9475	8528	120
		3150	39.5	124.4	13489	11366	108
		4200	41.2	172.9	17001	13883	98
BXRC-35E10K0-B-7x-SE	80	900	49.6	44.7	7969	7274	178
		1200	50.5	60.6	10493	9538	173
		1800	52.0	93.6	15350	13815	164
		2700	54.1	146.1	22127	19734	151
		3600	55.8	201.0	28321	24952	141

Notes for Table 4:

1. Alternate drive currents are provided for reference only and are not a guarantee of performance.
2. Bridgelux maintains a ± 7% tolerance on flux measurements.
3. Typical stabilized DC performance values are provided as reference only and are not a guarantee of performance.

Performance at Commonly Used Drive Currents

Table 4: Product Performance at Commonly Used Drive Currents (Continued)

Part Number	CRI	Drive Current ¹ (mA)	Typical V _f T _c = 25°C (V)	Typical Power T _c = 25°C (W)	Typical Flux ² T _c = 25°C (lm)	Typical DC Flux ³ T _c = 85°C (lm)	Typical Efficacy T _c = 25°C (lm/W)
BXRC-35E10K0-C-7x-SE	80	855	66.2	56.6	11056	10521	195
		1140	67.3	76.7	14052	12962	183
		1710	69.4	118.7	19463	17516	164
		2565	72.1	185.0	27610	23747	149
		3420	74.4	254.6	34606	29079	136
BXRC-35E10K0-D-7x-SE	80	1050	35.4	37.2	7123	6940	191
		1400	36.2	50.6	9167	8531	181
		2100	37.6	79.0	12949	11654	164
		3150	39.5	124.4	18435	15534	148
		4200	41.2	172.9	23235	18974	134
BXRC-35G10K0-B-7x-SE	90	900	49.6	44.7	6657	6076	149
		1200	50.5	60.6	8765	7968	145
		1800	52.0	93.6	12823	11541	137
		2700	54.1	146.1	18484	16485	127
		3600	55.8	201.0	23658	20844	118
BXRC-35G10K0-C-7x-SE	90	855	66.2	56.6	9236	8789	163
		1140	67.3	76.7	11739	10828	153
		1710	69.4	118.7	16258	14633	137
		2565	72.1	185.0	23064	19837	125
		3420	74.4	254.6	28909	24292	114
BXRC-35G10K0-D-7x-SE	90	1050	35.4	37.2	5950	5798	160
		1400	36.2	50.6	7658	7127	151
		2100	37.6	79.0	10818	9736	137
		3150	39.5	124.4	15400	12976	124
		4200	41.2	172.9	19410	15850	112
BXRC-35A10K1-B-73-SE	93	900	49.6	44.7	6268	5722	140
		1200	50.5	60.6	8253	7502	136
		1800	52.0	93.6	12074	10867	129
		2700	54.1	146.1	17405	15522	119
		3600	55.8	201.0	22277	19627	111
BXRC-35A10K1-C-73-SE	93	855	66.2	56.6	8697	8276	154
		1140	67.3	76.7	11053	10196	144
		1710	69.4	118.7	15309	13778	129
		2565	72.1	185.0	21718	18679	117
		3420	74.4	254.6	27221	22873	107
BXRC-35A10K1-D-73-SE	93	1050	35.4	37.2	5603	5459	151
		1400	36.2	50.6	7211	6710	142
		2100	37.6	79.0	10186	9167	129
		3150	39.5	124.4	14501	12218	117
		4200	41.2	172.9	18276	14924	106
BXRC-40C10K1-B-74-SE	70	900	49.6	44.7	8746	7984	196
		1200	50.5	60.6	11516	10468	190
		1800	52.0	93.6	16848	15163	180
		2700	54.1	146.1	24286	21659	166
		3600	55.8	201.0	31084	27387	155

Notes for Table 4:

1. Alternate drive currents are provided for reference only and are not a guarantee of performance.
2. Bridgelux maintains a ± 7% tolerance on flux measurements.
3. Typical stabilized DC performance values are provided as reference only and are not a guarantee of performance.

Performance at Commonly Used Drive Currents

Table 4: Product Performance at Commonly Used Drive Currents (Continued)

Part Number	CRI	Drive Current ¹ (mA)	Typical V _f T _c = 25°C (V)	Typical Power T _c = 25°C (W)	Typical Flux ² T _c = 25°C (lm)	Typical DC Flux ³ T _c = 85°C (lm)	Typical Efficacy T _c = 25°C (lm/W)
BXRC-40C10K1-C-74-SE	70	855	66.2	56.6	12135	11547	214
		1140	67.3	76.7	15423	14227	201
		1710	69.4	118.7	21361	19225	180
		2565	72.1	185.0	30304	26063	164
		3420	74.4	254.6	37983	31916	149
BXRC-40C10K1-D-74-SE	70	1050	35.4	37.2	7818	7617	210
		1400	36.2	50.6	10061	9363	199
		2100	37.6	79.0	14213	12792	180
		3150	39.5	124.4	20234	17049	163
		4200	41.2	172.9	25502	20825	147
BXRC-40E10K0-B-7x-SE	80	900	49.6	44.7	8017	7318	179
		1200	50.5	60.6	10557	9596	174
		1800	52.0	93.6	15444	13900	165
		2700	54.1	146.1	22262	19854	152
		3600	55.8	201.0	28493	25105	142
BXRC-40E10K0-C-7x-SE	80	855	66.2	56.6	11123	10585	197
		1140	67.3	76.7	14138	13041	184
		1710	69.4	118.7	19581	17623	165
		2565	72.1	185.0	27778	23891	150
		3420	74.4	254.6	34818	29256	137
BXRC-40E10K0-D-7x-SE	80	1050	35.4	37.2	7166	6983	193
		1400	36.2	50.6	9223	8583	182
		2100	37.6	79.0	13028	11726	165
		3150	39.5	124.4	18548	15628	149
		4200	41.2	172.9	23377	19089	135
BXRC-40G10K0-B-7x-SE	90	900	49.6	44.7	6900	6298	154
		1200	50.5	60.6	9085	8258	150
		1800	52.0	93.6	13291	11962	142
		2700	54.1	146.1	19159	17086	131
		3600	55.8	201.0	24521	21605	122
BXRC-40G10K0-C-7x-SE	90	855	66.2	56.6	9573	9110	169
		1140	67.3	76.7	12167	11223	159
		1710	69.4	118.7	16852	15167	142
		2565	72.1	185.0	23906	20561	129
		3420	74.4	254.6	29964	25178	118
BXRC-40G10K0-D-7x-SE	90	1050	35.4	37.2	6167	6009	166
		1400	36.2	50.6	7937	7387	157
		2100	37.6	79.0	11212	10091	142
		3150	39.5	124.4	15962	13450	128
		4200	41.2	172.9	20118	16428	116
BXRC-40H10K0-D-7x-SE	97	1050	35.4	37.2	5299	5163	142
		1400	36.2	50.6	6819	6346	135
		2100	37.6	79.0	9633	8670	122
		3150	39.5	124.4	13714	11555	110
		4200	41.2	172.9	17285	14114	100

Notes for Table 4:

1. Alternate drive currents are provided for reference only and are not a guarantee of performance.
2. Bridgelux maintains a ± 7% tolerance on flux measurements.
3. Typical stabilized DC performance values are provided as reference only and are not a guarantee of performance.

Performance at Commonly Used Drive Currents

Table 4: Product Performance at Commonly Used Drive Currents (Continued)

Part Number	CRI	Drive Current ¹ (mA)	Typical V_f $T_c = 25^\circ\text{C}$ (V)	Typical Power $T_c = 25^\circ\text{C}$ (W)	Typical Flux ² $T_c = 25^\circ\text{C}$ (lm)	Typical DC Flux ³ $T_c = 85^\circ\text{C}$ (lm)	Typical Efficacy $T_c = 25^\circ\text{C}$ (lm/W)
BXRC-40A10K1-B-73-SE	93	900	49.6	44.7	6705	6121	150
		1200	50.5	60.6	8829	8026	146
		1800	52.0	93.6	12917	11625	138
		2700	54.1	146.1	18619	16605	127
		3600	55.8	201.0	23831	20997	119
BXRC-40A10K1-C-73-SE	93	855	66.2	56.6	9303	8853	164
		1140	67.3	76.7	11824	10907	154
		1710	69.4	118.7	16377	14739	138
		2565	72.1	185.0	23233	19982	126
		3420	74.4	254.6	29120	24469	114
BXRC-40A10K1-D-73-SE	93	1050	35.4	37.2	5994	5840	161
		1400	36.2	50.6	7714	7179	152
		2100	37.6	79.0	10896	9807	138
		3150	39.5	124.4	15513	13071	125
		4200	41.2	172.9	19552	15966	113
BXRC-50C10K1-B-74-SE	70	900	49.6	44.7	8843	8072	198
		1200	50.5	60.6	11644	10585	192
		1800	52.0	93.6	17035	15332	182
		2700	54.1	146.1	24556	21899	168
		3600	55.8	201.0	31429	27691	156
BXRC-50C10K1-C-74-SE	70	855	66.2	56.6	12270	11676	217
		1140	67.3	76.7	15594	14385	203
		1710	69.4	118.7	21599	19439	182
		2565	72.1	185.0	30640	26353	166
		3420	74.4	254.6	38405	32271	151
BXRC-50C10K1-D-74-SE	70	1050	35.4	37.2	7905	7702	212
		1400	36.2	50.6	10173	9467	201
		2100	37.6	79.0	14371	12934	182
		3150	39.5	124.4	20459	17238	165
		4200	41.2	172.9	25785	21056	149
BXRC-50E10K1-B-74-SE	80	900	49.6	44.7	8309	7585	186
		1200	50.5	60.6	10940	9945	181
		1800	52.0	93.6	16006	14405	171
		2700	54.1	146.1	23072	20576	158
		3600	55.8	201.0	29529	26018	147
BXRC-50E10K1-C-74-SE	80	855	66.2	56.6	11528	10970	204
		1140	67.3	76.7	14652	13516	191
		1710	69.4	118.7	20293	18264	171
		2565	72.1	185.0	28788	24760	156
		3420	74.4	254.6	36084	30320	142
BXRC-50E10K1-D-74-SE	80	1050	35.4	37.2	7427	7236	200
		1400	36.2	50.6	9558	8895	189
		2100	37.6	79.0	13502	12152	171
		3150	39.5	124.4	19222	16197	155
		4200	41.2	172.9	24227	19783	140

Notes for Table 4:

1. Alternate drive currents are provided for reference only and are not a guarantee of performance.
2. Bridgelux maintains a $\pm 7\%$ tolerance on flux measurements.
3. Typical stabilized DC performance values are provided as reference only and are not a guarantee of performance.

Performance at Commonly Used Drive Currents

Table 4: Product Performance at Commonly Used Drive Currents (Continued)

Part Number	CRI	Drive Current ¹ (mA)	Typical V_f $T_c = 25^\circ\text{C}$ (V)	Typical Power $T_c = 25^\circ\text{C}$ (W)	Typical Flux ² $T_c = 25^\circ\text{C}$ (lm)	Typical DC Flux ³ $T_c = 85^\circ\text{C}$ (lm)	Typical Efficacy $T_c = 25^\circ\text{C}$ (lm/W)
BXRC-50G10K1-B-74-SE	90	900	49.6	44.7	7046	6431	158
		1200	50.5	60.6	9277	8433	153
		1800	52.0	93.6	13572	12215	145
		2700	54.1	146.1	19564	17447	134
		3600	55.8	201.0	25040	22062	125
BXRC-50G10K1-C-74-SE	90	855	66.2	56.6	9775	9302	173
		1140	67.3	76.7	12424	11461	162
		1710	69.4	118.7	17208	15487	145
		2565	72.1	185.0	24411	20996	132
		3420	74.4	254.6	30597	25710	120
BXRC-50G10K1-D-74-SE	90	1050	35.4	37.2	6298	6136	169
		1400	36.2	50.6	8105	7543	160
		2100	37.6	79.0	11449	10304	145
		3150	39.5	124.4	16300	13734	131
		4200	41.2	172.9	20543	16775	119
BXRC-56G10K0-B-74-SE	80	900	49.6	44.7	7386	6742	165
		1200	50.5	60.6	9725	8840	161
		1800	52.0	93.6	14227	12804	152
		2700	54.1	146.1	20508	18290	140
		3600	55.8	201.0	26248	23127	131
BXRC-56G10K0-C-74-SE	80	855	66.2	56.6	10247	9751	181
		1140	67.3	76.7	13024	12014	170
		1710	69.4	118.7	18038	16235	152
		2565	72.1	185.0	25590	22009	138
		3420	74.4	254.6	32074	26951	126
BXRC-56G10K0-D-74-SE	80	1050	35.4	37.2	6602	6432	177
		1400	36.2	50.6	8496	7907	168
		2100	37.6	79.0	12002	10802	152
		3150	39.5	124.4	17087	14397	137
		4200	41.2	172.9	21535	17585	125
BXRC-56H10K0-D-74-SE	80	1050	35.4	37.2	5733	5586	154
		1400	36.2	50.6	7378	6866	146
		2100	37.6	79.0	10423	9380	132
		3150	39.5	124.4	14838	12503	119
		4200	41.2	172.9	18701	15271	108
BXRC-57C10K1-B-74-SE	70	900	49.6	44.7	8552	7806	191
		1200	50.5	60.6	11260	10236	186
		1800	52.0	93.6	16474	14826	176
		2700	54.1	146.1	23746	21177	163
		3600	55.8	201.0	30393	26778	151
BXRC-57C10K1-C-74-SE	70	855	66.2	56.6	11865	11291	210
		1140	67.3	76.7	15080	13911	197
		1710	69.4	118.7	20887	18798	176
		2565	72.1	185.0	29630	25484	160
		3420	74.4	254.6	37139	31207	146

Notes for Table 4:

1. Alternate drive currents are provided for reference only and are not a guarantee of performance.
2. Bridgelux maintains a $\pm 7\%$ tolerance on flux measurements.
3. Typical stabilized DC performance values are provided as reference only and are not a guarantee of performance.

Performance at Commonly Used Drive Currents

Table 4: Product Performance at Commonly Used Drive Currents (Continued)

Part Number	CRI	Drive Current ¹ (mA)	Typical V _f T _c = 25°C (V)	Typical Power T _c = 25°C (W)	Typical Flux ² T _c = 25°C (lm)	Typical DC Flux ³ T _c = 85°C (lm)	Typical Efficacy T _c = 25°C (lm/W)
BXRC-57C10K1-D-74-SE	70	1050	35.4	37.2	7644	7448	205
		1400	36.2	50.6	9838	9155	194
		2100	37.6	79.0	13897	12507	176
		3150	39.5	124.4	19784	16670	159
		4200	41.2	172.9	24935	20362	144
BXRC-57E10K1-B-74-SE	80	900	49.6	44.7	8212	7496	184
		1200	50.5	60.6	10812	9829	179
		1800	52.0	93.6	15818	14237	169
		2700	54.1	146.1	22802	20335	156
		3600	55.8	201.0	29184	25713	145
BXRC-57E10K1-C-74-SE	80	855	66.2	56.6	11393	10842	201
		1140	67.3	76.7	14481	13357	189
		1710	69.4	118.7	20056	18050	169
		2565	72.1	185.0	28452	24471	154
		3420	74.4	254.6	35662	29966	140
BXRC-57E10K1-D-74-SE	80	1050	35.4	37.2	7340	7152	197
		1400	36.2	50.6	9446	8791	187
		2100	37.6	79.0	13344	12010	169
		3150	39.5	124.4	18998	16007	153
		4200	41.2	172.9	23944	19552	138
BXRC-65C10K1-B-74-SE	70	900	49.6	44.7	8698	7939	195
		1200	50.5	60.6	11452	10410	189
		1800	52.0	93.6	16754	15079	179
		2700	54.1	146.1	24151	21538	165
		3600	55.8	201.0	30911	27235	154
BXRC-65C10K1-C-74-SE	70	855	66.2	56.6	12067	11483	213
		1140	67.3	76.7	15337	14148	200
		1710	69.4	118.7	21243	19118	179
		2565	72.1	185.0	30135	25919	163
		3420	74.4	254.6	37772	31739	148
BXRC-65C10K1-D-74-SE	70	1050	35.4	37.2	7774	7575	209
		1400	36.2	50.6	10005	9311	198
		2100	37.6	79.0	14134	12720	179
		3150	39.5	124.4	20122	16954	162
		4200	41.2	172.9	25360	20709	147
BXRC-65E10K1-B-74-SE	80	900	49.6	44.7	8357	7629	187
		1200	50.5	60.6	11004	10003	182
		1800	52.0	93.6	16099	14489	172
		2700	54.1	146.1	23207	20696	159
		3600	55.8	201.0	29702	26170	148
BXRC-65E10K1-C-7x-SE	80	855	66.2	56.6	11595	11034	205
		1140	67.3	76.7	14738	13595	192
		1710	69.4	118.7	20412	18371	172
		2565	72.1	185.0	28957	24905	157
		3420	74.4	254.6	36295	30498	143

Notes for Table 4:

1. Alternate drive currents are provided for reference only and are not a guarantee of performance.
2. Bridgelux maintains a ± 7% tolerance on flux measurements.
3. Typical stabilized DC performance values are provided as reference only and are not a guarantee of performance.

Performance at Commonly Used Drive Currents

Table 4: Product Performance at Commonly Used Drive Currents (Continued)

Part Number	CRI	Drive Current ¹ (mA)	Typical V_f $T_c = 25^\circ\text{C}$ (V)	Typical Power $T_c = 25^\circ\text{C}$ (W)	Typical Flux ² $T_c = 25^\circ\text{C}$ (lm)	Typical DC Flux ³ $T_c = 85^\circ\text{C}$ (lm)	Typical Efficacy $T_c = 25^\circ\text{C}$ (lm/W)
BXRC-65E10K1-D-7X-SE	80	1050	35.4	37.2	7470	7279	201
		1400	36.2	50.6	9614	8947	190
		2100	37.6	79.0	13581	12223	172
		3150	39.5	124.4	19335	16291	155
		4200	41.2	172.9	24369	19899	141

Notes for Table 4:

1. Alternate drive currents are provided for reference only and are not a guarantee of performance.
2. Bridgelux maintains a $\pm 7\%$ tolerance on flux measurements.
3. Typical stabilized DC performance values are provided as reference only and are not a guarantee of performance.

Electrical Characteristics

Table 5: Electrical Characteristics

Part Number	Drive Current (mA)	Forward Voltage Pulsed, $T_c = 25^\circ\text{C}$ (V) ^{1, 2, 3, 8}			Typical Coefficient of Forward Voltage ⁴ $\Delta V_f / \Delta T_c$ (mV/ $^\circ\text{C}$)	Typical Thermal Resistance Junction to Case ^{5,6} R_{j-c} ($^\circ\text{C}/\text{W}$)	Driver Selection Voltages ⁷ (V)	
		Minimum	Typical	Maximum			V_f Min. Hot $T_c = 105^\circ\text{C}$ (V)	V_f Max. Cold $T_c = -40^\circ\text{C}$ (V)
BXRC-xxx10Kx-B-7x-SE	1800	48.1	52.0	55.9	-24.9	0.06	46.1	57.5
	3600	51.7	55.8	60.0	-24.9	0.07	49.7	61.6
BXRC-xxx10Kx-C-7x-SE	1710	64.2	69.4	74.6	-33.2	0.04	61.5	76.8
	3420	68.8	74.4	80.0	-33.2	0.05	66.2	82.2
BXRC-xxx10Kx-D-7x-SE	2100	34.8	37.6	40.4	-17.4	0.06	33.4	41.6
	4200	38.1	41.2	44.3	-17.4	0.07	36.7	45.4

Notes for Table 5:

- Parts are tested in pulsed conditions. $T_c = 25^\circ\text{C}$. Pulse width is 10ms.
- Voltage minimum and maximum are provided for reference only and are not a guarantee of performance.
- Bridgelux maintains a tester tolerance of $\pm 0.10\text{V}$ on forward voltage measurements.
- Typical coefficient of forward voltage tolerance is $\pm 0.1\text{mV}$ for nominal current.
- Thermal resistance values are based from test data of a 3000K 80 CRI product.
- Thermal resistance value was calculated using total electrical input power; optical power was not subtracted from input power. The thermal interface material used during testing is not included in the thermal resistance value.
- V_f min hot and max cold values are provided as reference only and are not guaranteed by test. These values are provided to aid in driver design and selection over the operating range of the product.
- This product has been designed and manufactured per IEC 62031:2014. This product has passed dielectric withstand voltage testing at 1160 V. The working voltage designated for the insulation is 80V d.c. The maximum allowable voltage across the array must be determined in the end product application.

Eye Safety

Table 6: Eye Safety Risk Group (RG) Classifications

Part Number	Drive Current ⁵ (mA)	CCT ⁵			
		2700K/3000K	4000K ²	5000K ³	6500K ⁴
BXRC-xxx10Kx-B-7x-SE	1800	RG1	RG1	RG1	RG1
	2700	RG1	RG1	RG2	RG2
	3600	RG1	RG1	RG2	RG2
BXRC-xxx10Kx-C-7x-SE	1710	RG1	RG1	RG1	RG2
	2565	RG1	RG1	RG2	RG2
	3420	RG1	RG2	RG2	RG2
BXRC-xxx10Kx-D-7x-SE	2100	RG1	RG1	RG1	RG1
	3150	RG1	RG1	RG1	RG2
	4200	RG1	RG1	RG2	RG2

Notes for Table 6:

1. Eye safety classification for the use of Bridgelux Vero SE Series LED arrays is in accordance with specification IEC/TR 62778: Application of IEC 62471 for the assessment of blue light hazard to light sources and luminaires.
2. For products classified as RG2 at 4000K, $E_{thr} = 1847.5$ lx.
3. For products classified as RG2 at 5000K $E_{thr} = 1315.8$ lx.
4. For products classified as RG2 at 6500K, $E_{thr} = 1124.5$ lx.
5. Please contact your Bridgelux sales representative for E_{thr} values at specific drive currents and CCTs not listed.

Absolute Maximum Ratings

Table 7: Maximum Ratings

Parameter	Maximum Rating		
LED Junction Temperature (T_j)	150°C		
Storage Temperature	-40°C to +105°C		
Operating Case Temperature ¹ (T_c)	105°C		
	BXRC-xxx10Kx-B-7x-SE	BXRC-xxx10Kx-C-7x-SE	BXRC-xxx10Kx-D-7x-SE
Maximum Drive Current ³	3600mA	3420mA	4200mA
Maximum Peak Pulsed Drive Current ⁴	5140mA	4890mA	6000mA
Maximum Reverse Voltage ⁵	-90V	-120V	-65V

Notes for Table 7:

1. For IEC 62717 requirement, please consult your Bridgelux sales representative.
2. Refer to Bridgelux Application Note AN120: Assembly Considerations for Bridgelux Vero SE LED Arrays.
3. Arrays may be driven at higher currents however lumen maintenance may be reduced.
4. Bridgelux recommends a maximum duty cycle of 10% and pulse width of 20 ms when operating LED Arrays at maximum peak pulsed current specified. Maximum peak pulsed currents indicate values where LED Arrays can be driven without catastrophic failures.
5. Light emitting diodes are not designed to be driven in reverse voltage and will not produce light under this condition. Maximum rating provided for reference only.

Performance Curves

Figure 1: Vero SE 29B Drive Current vs. Voltage

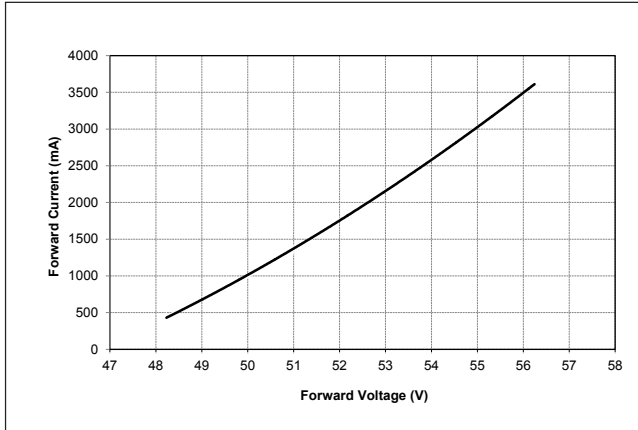

Figure 2: Vero SE 29C Drive Current vs. Voltage

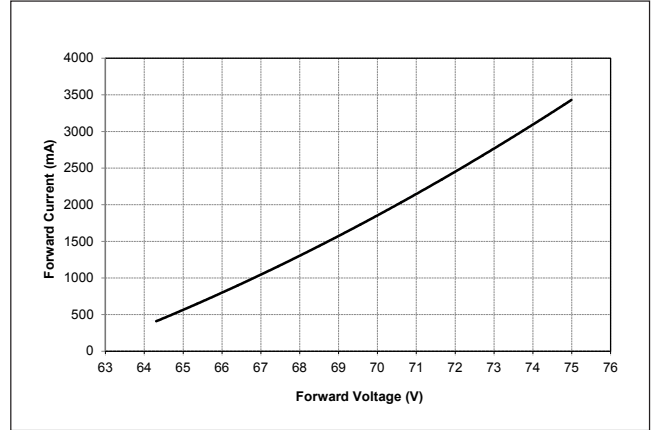

Figure 3: Vero SE 29D Drive Current vs. Voltage

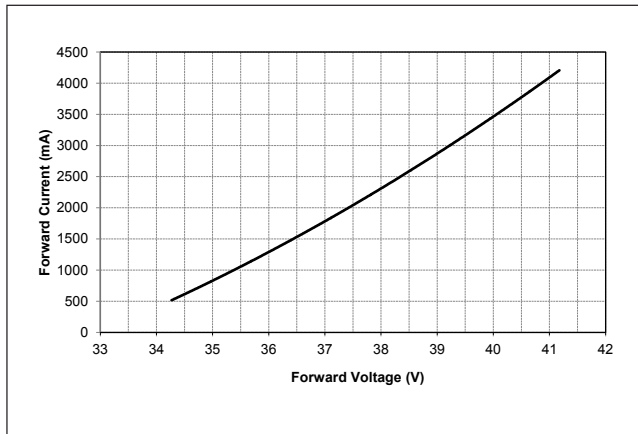

Figure 4: Vero SE 29B Typical Relative Flux vs. Current

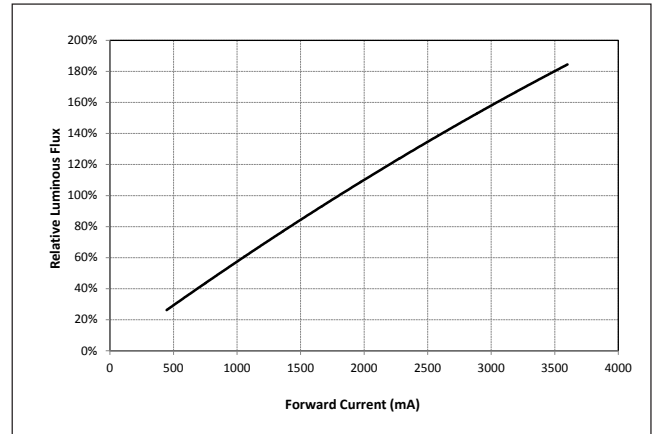

Figure 5: Vero SE 29C Typical Relative Flux vs. Current

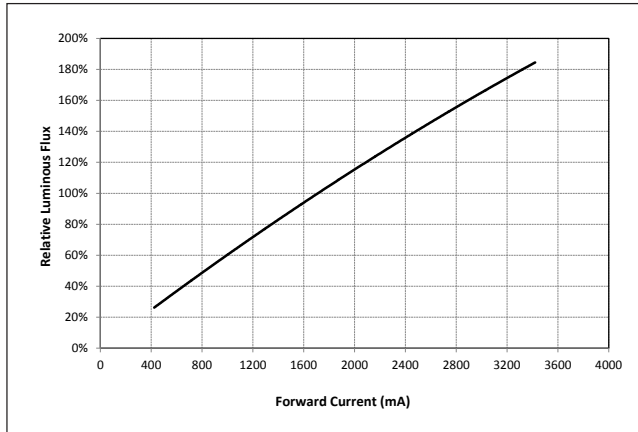
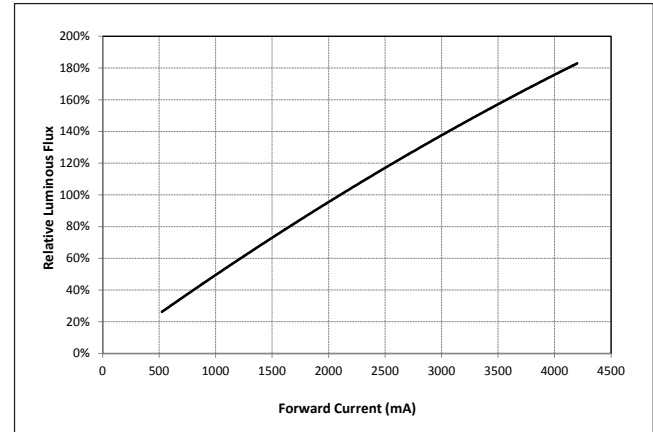

Figure 6: Vero SE 29D Typical Relative Flux vs. Current



Notes for Figures 1-6:

1. Bridgelux does not recommend driving high power LEDs at low currents. Doing so may produce unpredictable results. Pulse width modulation (PWM) is recommended for dimming effects.
2. Products tested under pulsed condition (10ms pulse width) at nominal test current where T_J (junction temperature) = T_C (case temperature) = 25°C.

Performance Curves

Figure 7: Typical DC Flux vs. Case Temperature

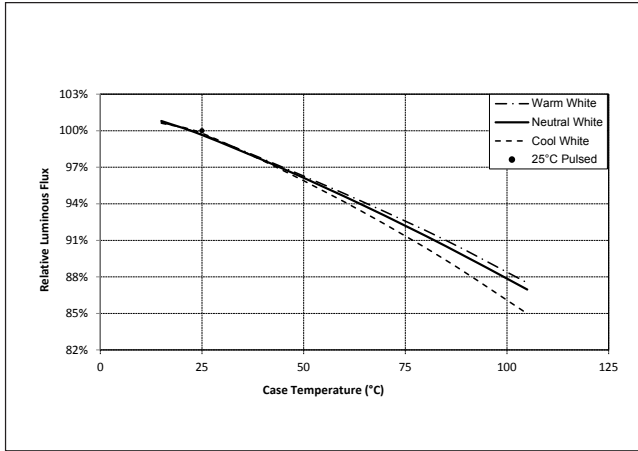

Figure 8: Typical DC ccy Shift vs. Case Temperature

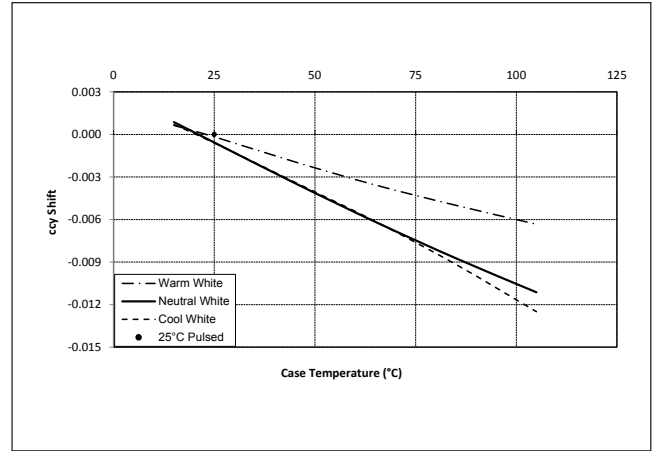

Figure 9: Typical DC ccx Shift vs. Case Temperature

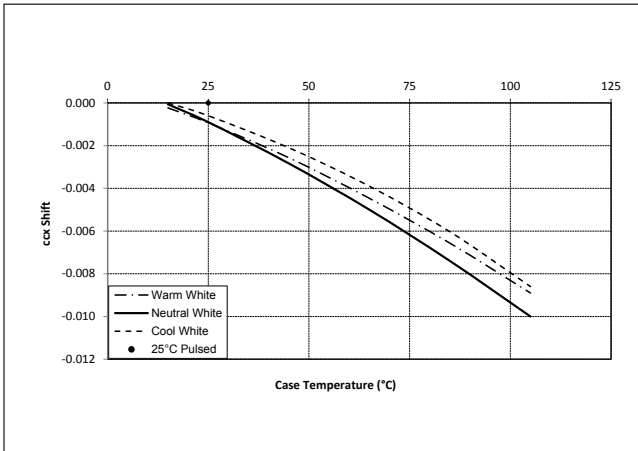
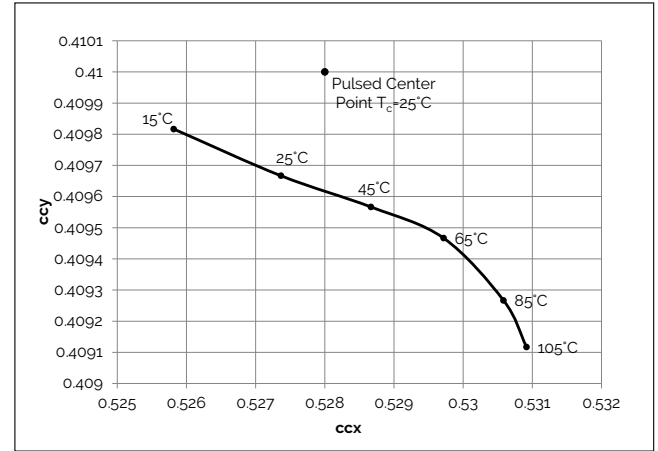

Figure 10: 2000K, 65 CRI Color Shift vs. Case Temperature



Notes for Figures 7-9:

1. Characteristics shown for warm white based on 3000K and 80 CRI.
2. Characteristics shown for neutral white based on 4000K and 80 CRI.
3. Characteristics shown for cool white based on 5000K and 70 CRI.
4. For other color SKUs, the shift in color will vary. Please contact your Bridgelux Sales Representative for more information.

Performance Curves

Figure 11: 1750K Color Shift vs. Case Temperature¹

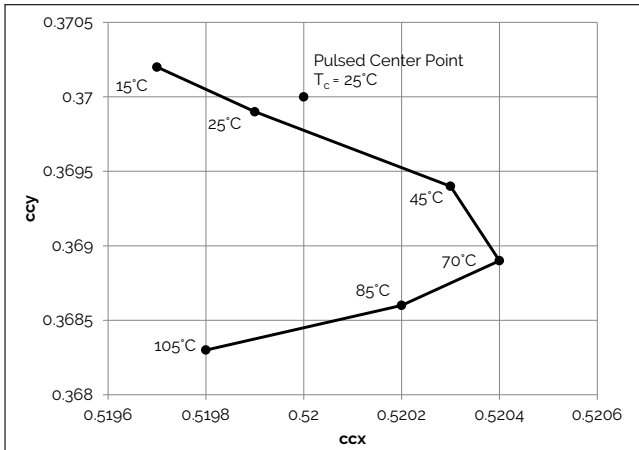

Figure 12: 2500K Color Shift vs. Case Temperature¹

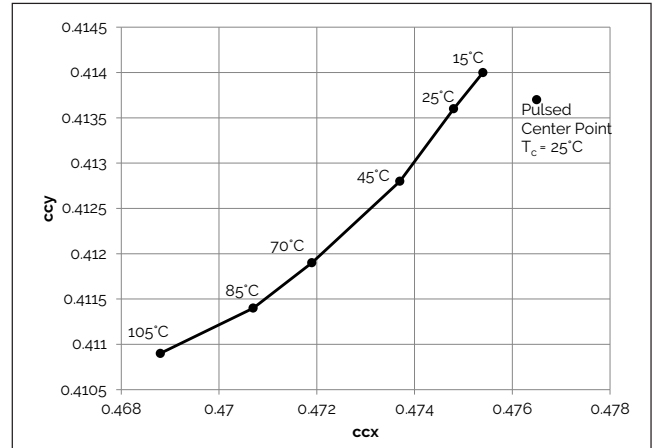

Figure 13: 5600K Color Shift vs. Case Temperature^{1,3}

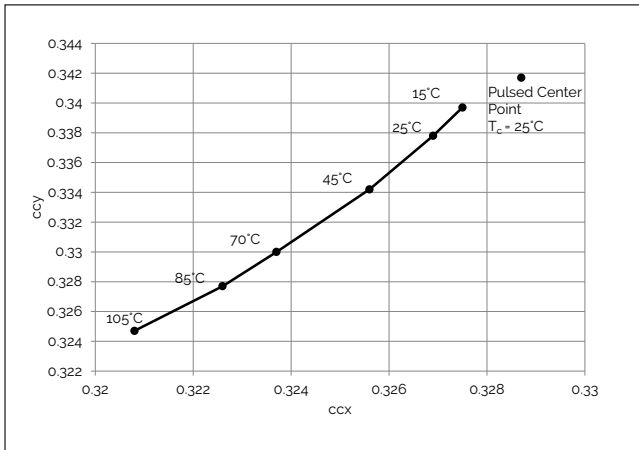

Figure 14: 3000K Class A Color Shift vs. Case Temperature¹

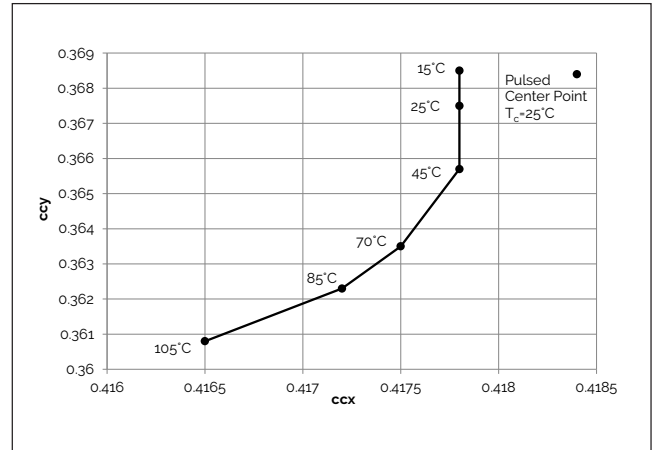

Figure 15: 3500K Class A Color Shift vs. Case Temperature¹

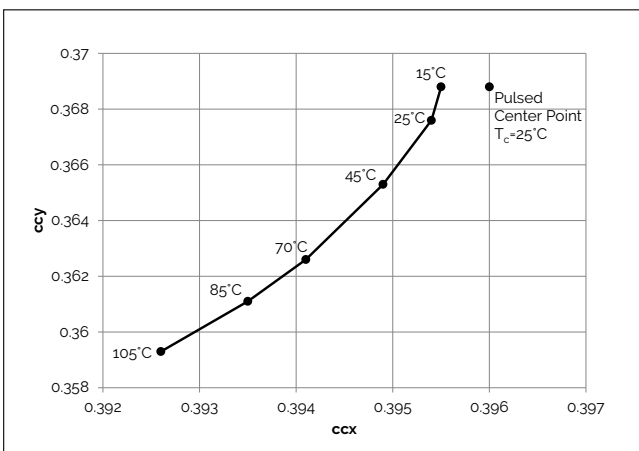
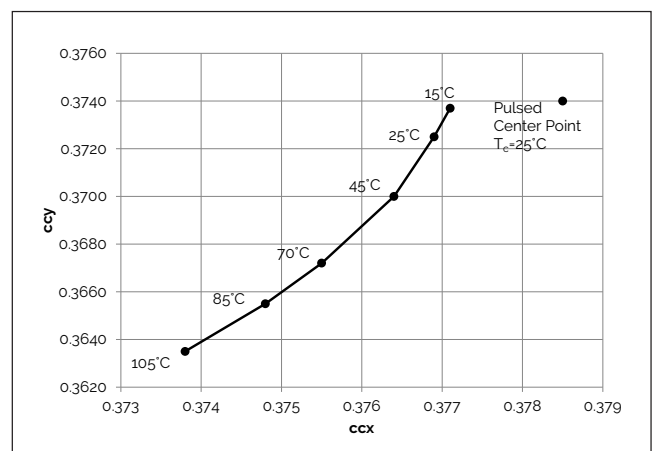

Figure 16: 4000K Class A Color Shift vs. Case Temperature¹



Note for Figures 10-16:

1. Measurements made under DC test conditions at the nominal drive current.
2. Typical color shift is shown with a tolerance of ± 0.002 .
3. Color shift shown for product hot targeted at $T_c = 85^\circ\text{C}$

Performance Curves

Figure 17: Vero SE 29D Drive Current Derating Curve

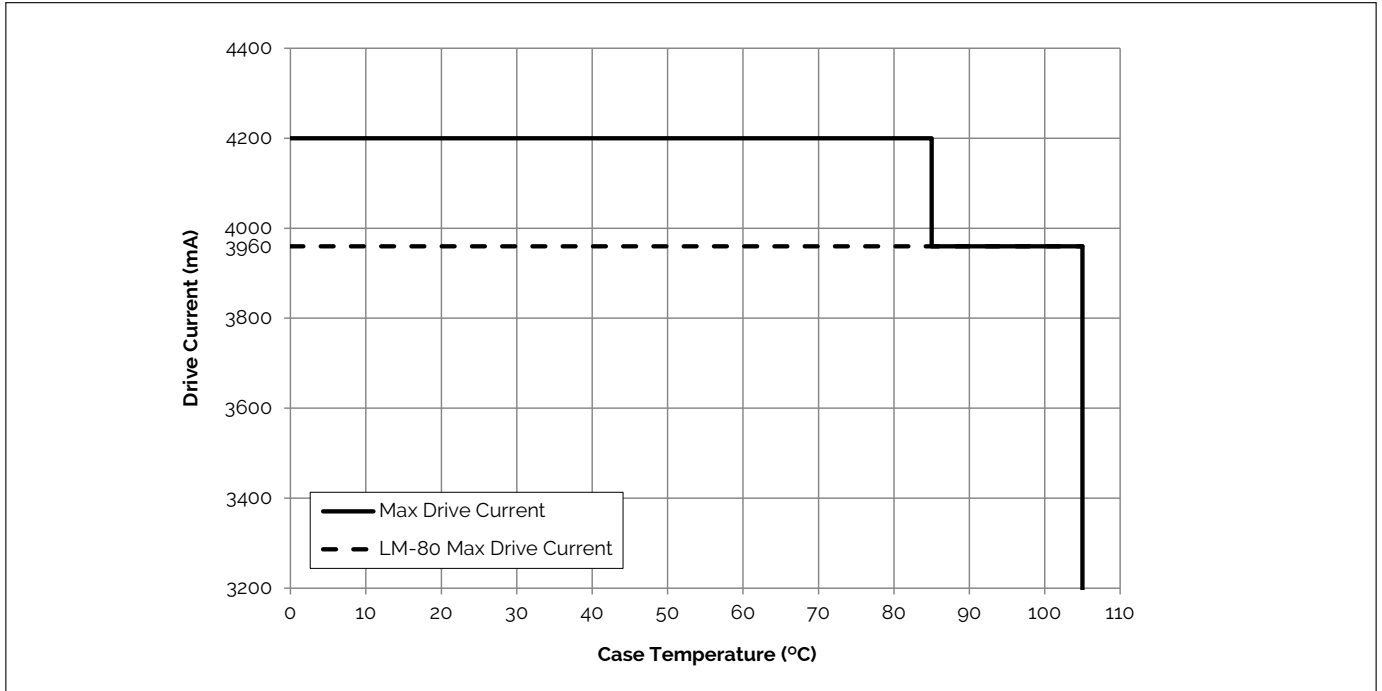

Notes for Figure 17:

1. The maximum allowable drive current for the Vero 29D product is dependent on the operating case temperature. Please refer to the Product Feature Map (page 2) for the location of the T_c Point
2. LM-80 Max Drive Current must not be exceeded in order to meet LM-80 lifetime projections.
3. Lumen maintenance (L70) and lifetime predictions are valid for drive current and case temperature conditions used for LM-80 testing as included in the applicable LM-80 test report for these products. Contact your Bridgelux sales representative for LM-80 report.

Typical Radiation Pattern

Figure 18: Typical Spatial Radiation Pattern

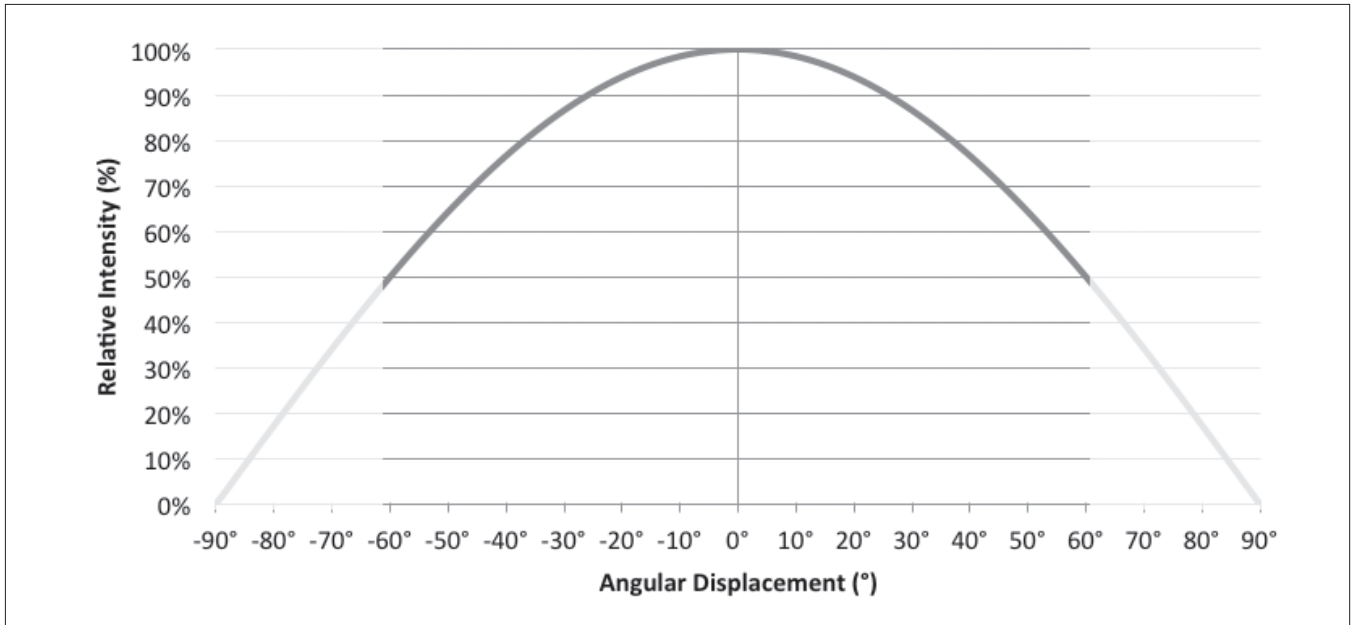

Note for Figure 18:

1. Typical viewing angle is 120°.
2. The viewing angle is defined as the off axis angle from the centerline where intensity is ½ of the peak value.

Figure 19: Typical Polar Radiation Pattern

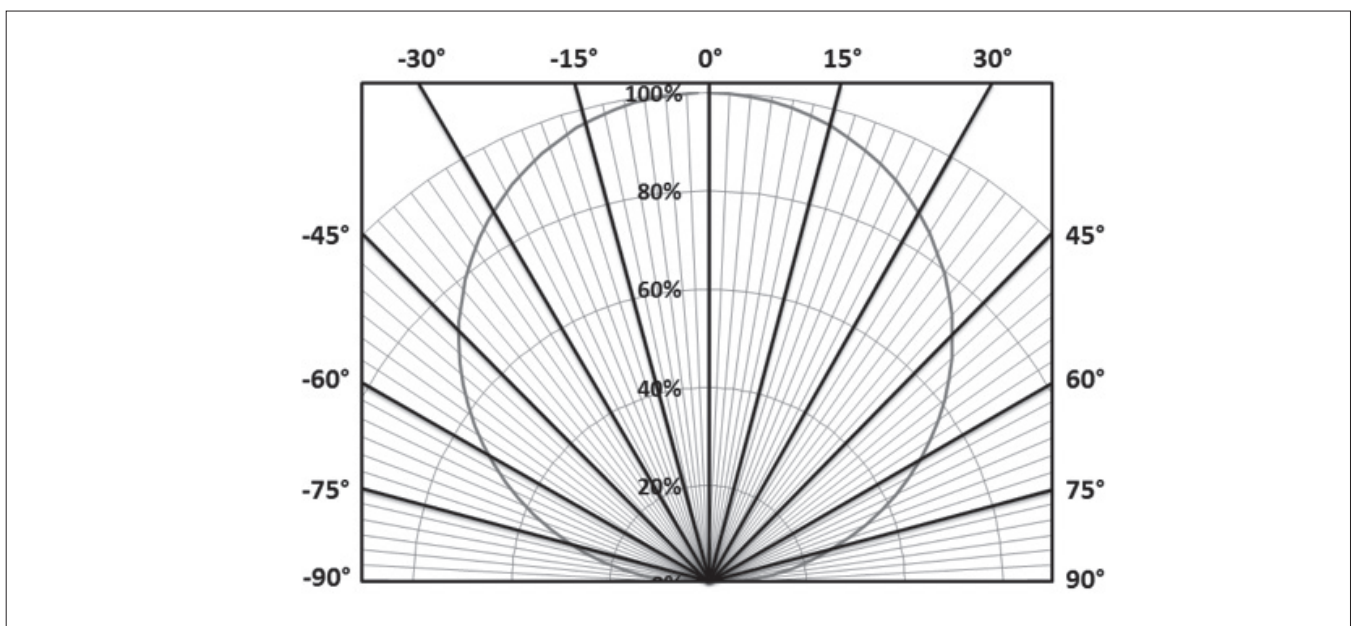

Typical Color Spectrum

Figure 20: Typical Color Spectrum

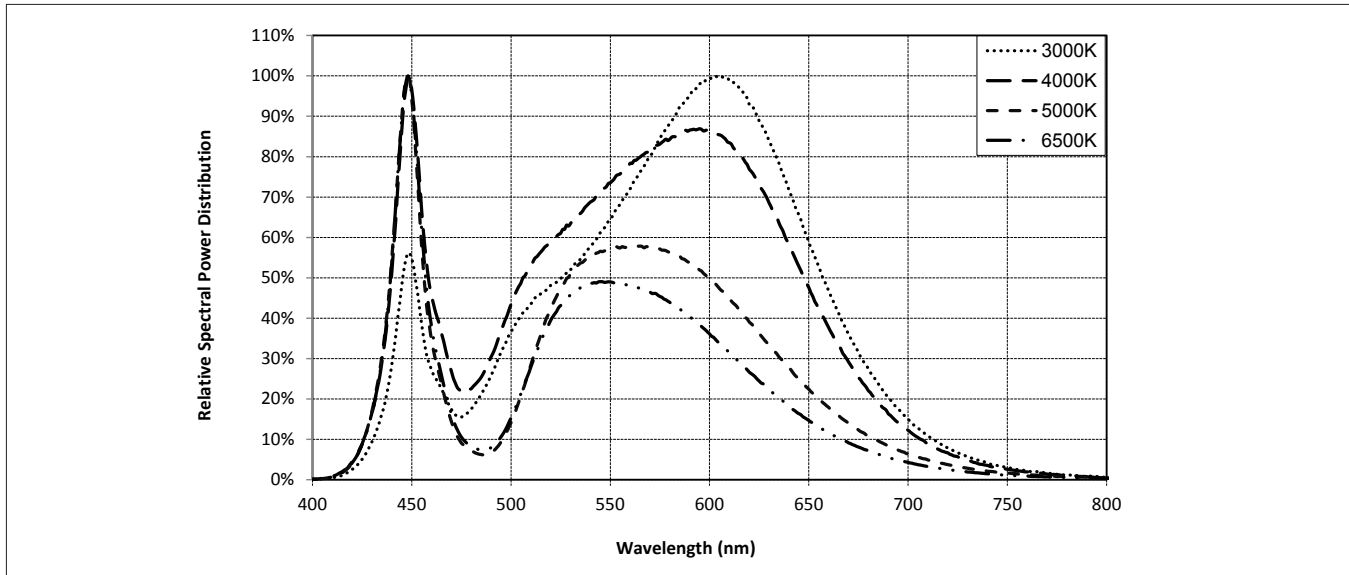

Note for Figure 20:

1. Color spectra measured at nominal current for $T_j = T_c = 25^\circ\text{C}$.
2. Color spectra shown is 3000K and 80 CRI.
3. Color spectra shown is 4000K and 80 CRI.
4. Color spectra shown is 5000K and 70 CRI.
4. Color spectra shown is 6500K and 70 CRI.

Figure 21: Typical Color Spectrum for Vero SE 29 with Décor Series

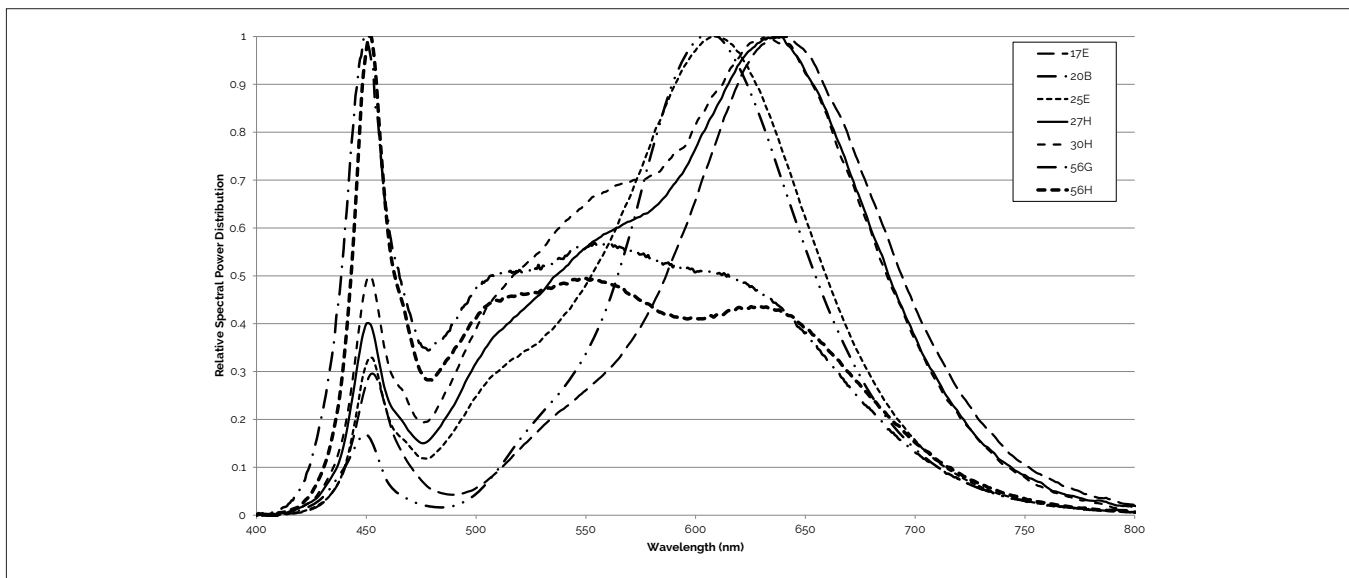

Note for Figure 21:

1. Color spectra measured at nominal current for $T_j = T_c = 25^\circ\text{C}$.

Mechanical Dimensions

Figure 22: Drawing for Vero SE 29 LED Array

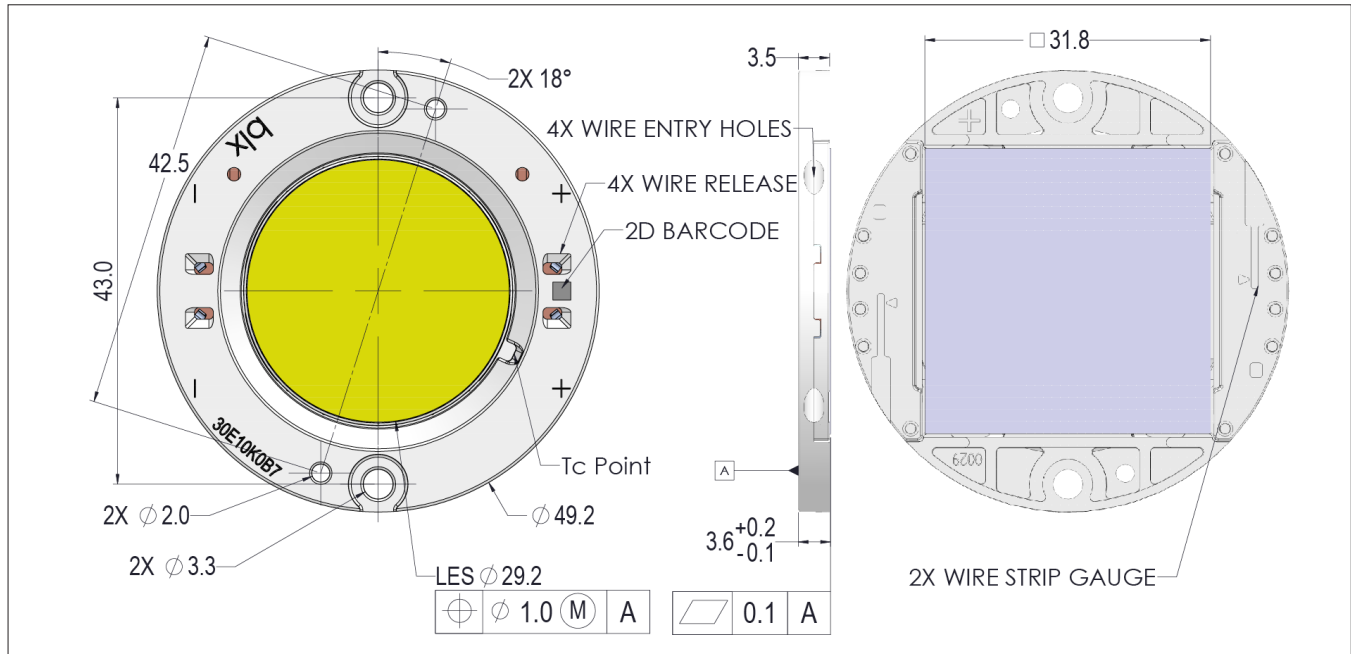

Notes for Figure 22:

1. Drawings are not to scale.
2. Drawing dimensions are in millimeters.
3. Unless otherwise specified, tolerances are ± 0.10 mm.
4. Mounting holes (2X) are for M3 screws.
5. Bridgelux recommends two tapped holes for mounting screws with 43.0 ± 0.10 mm center-to-center spacing.
6. Screws with flat shoulders (pan, dome, button, round, truss, mushroom) provide optimal torque control. Do NOT use flat, countersink, or raised head screws.
7. The optical center of the LED Array is nominally defined by the mechanical center of the array to a tolerance of ± 0.2 mm.
8. Bridgelux maintains a flatness of 0.10mm across the mounting surface of the array.

Color Binning Information

Figure 23: Graph of Warm and Neutral White Test Bins in xy Color Space

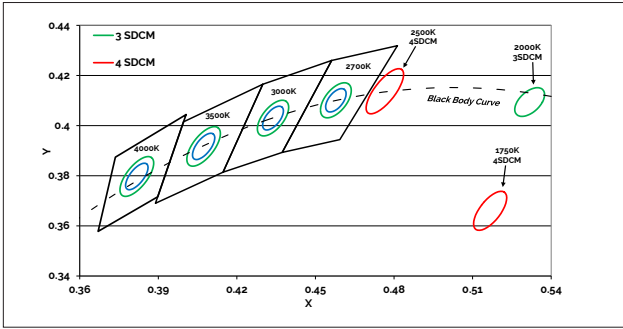

Note: Pulsed Test Conditions, $T_c = 25^\circ\text{C}$

Table 8: Warm and Neutral White xy Bin Coordinates and Associated Typical CCT

Bin Code	1750K	2500K	2700K	3000K ¹	3500K ¹	4000K ¹
ANSI Bin (for reference only)	-	-	(2580K - 2870K)	(2870K - 3220K)	(3220K - 3710K)	(3710K - 4260K)
73 (3 SDCM)	-	-	(2651K - 2794K)	(2968K - 3136K)	(3369K - 3586K)	(3851K - 4130K)
72 (2 SDCM)	-	-	(2674K - 2769K)	(2995K - 3107K)	(3404K - 3548K)	(3895K - 4081K)
Center Point (x,y)	(0.5167, 0.336)	(0.4765, 0.4137)	(0.4578, 0.4101)	(0.4338, 0.403)	(0.4073, 0.3917)	(0.3818, 0.3797)

Note for Table 8:

- Color Binning information excludes Class A products. Please contact your Bridgelux Sales Representative for more information.

Figure 24: Graph of Cool White Test Bins in xy Color Space

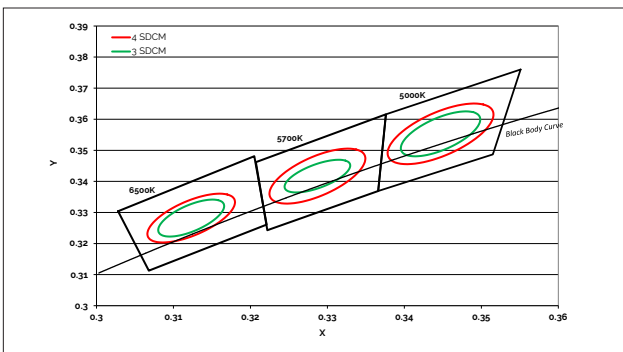

Note: Pulsed Test Conditions, $T_c = 25^\circ\text{C}$

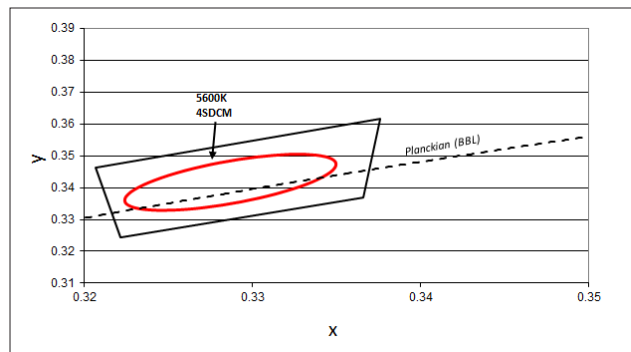

Note: Pulsed Test Conditions, $T_c = 25^\circ\text{C}$

Table 9: Cool White xy Bin Coordinates and Associated Typical CCT (product is hot targeted to $T_c = 85^\circ\text{C}$)

Bin Code	5000K	5600K ¹	5700K	6500K
ANSI Bin (for reference only)	(4745K - 5311K)	(5310K - 6020K)	(5312K - 6022K)	(6022K - 7042K)
74 (4 SDCM)	(4801K - 5282K)	(5475K - 5830K)	(5829K - 5481K)	(6270K - 6765K)
73 (3 SDCM)	(4835K - 5215K)	(5490K - 5820K)	(5490K - 5820K)	(6250K - 6745K)
Center Point (x,y)	(0.3447, 0.3553)	(0.3293, 0.3423)	(0.3287, 0.3417)	(0.3123, 0.3282)

Note for Table 9:

- Select configurations with a CCT of 5600K are available with center point targets at $T_c = 85^\circ\text{C}$ or $T_c = 25^\circ\text{C}$.

Packaging and Labeling

Figure 25: Drawing for Vero SE 29 Packaging Tray

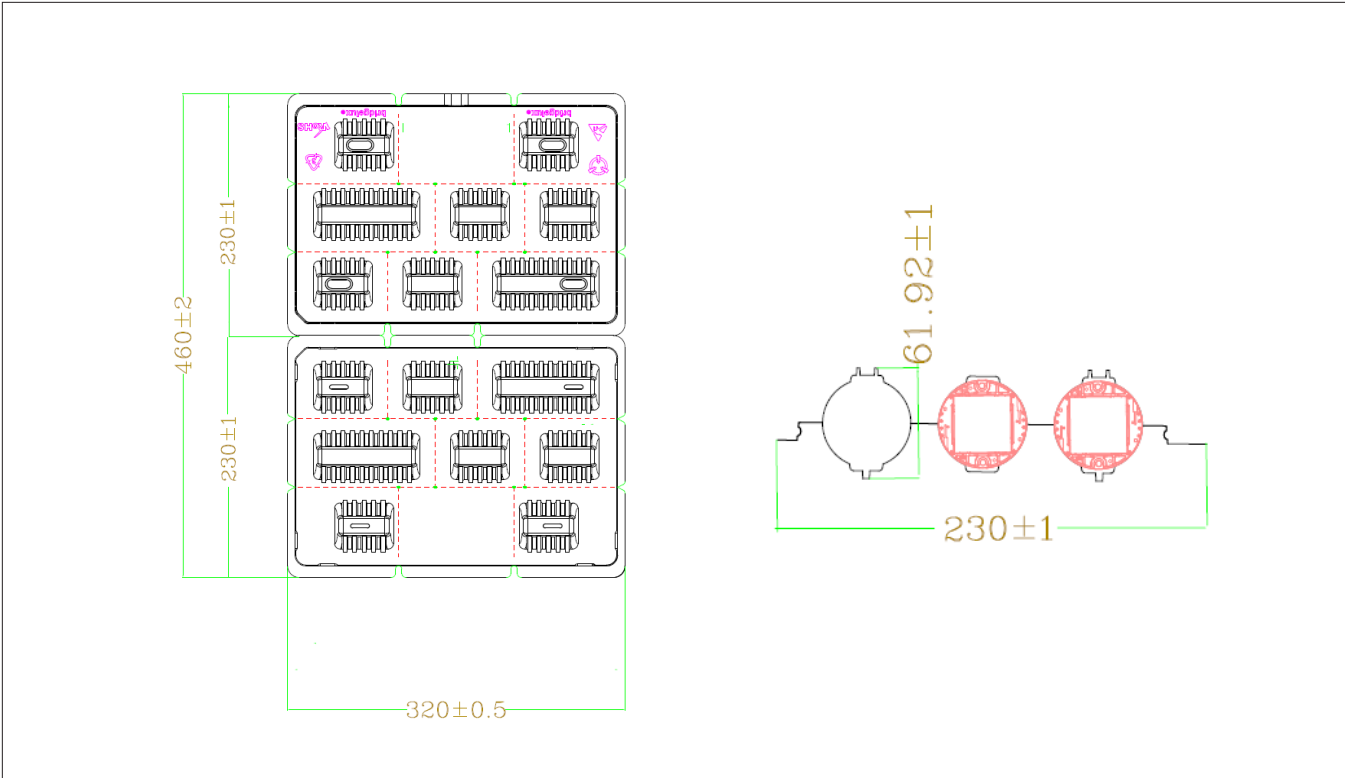

- Notes for Figure 25:
- 1. Dimensions are in millimeters.
 - 2. Drawings are not to scale.

Packaging and Labeling

Figure 26: Vero SE Series Packaging and Labeling

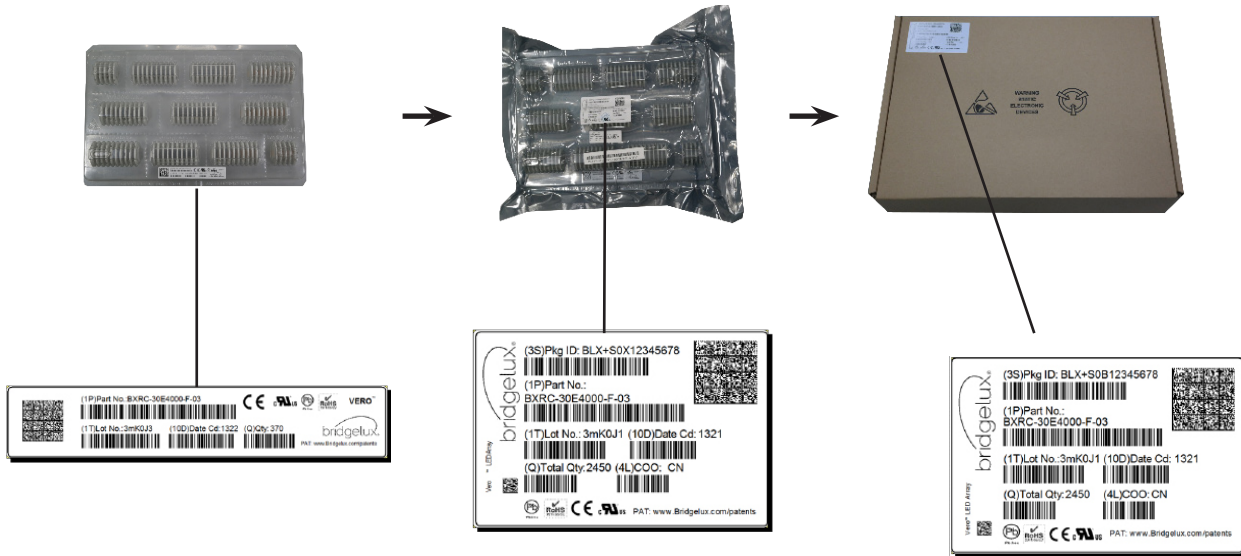

Notes for Figure 26:

1. Each tray holds 50 COBs.
2. Each tray is vacuum sealed in an anti-static bag and placed in its own box.
3. Each tray, bag and box is to be labeled as shown above.

Figure 27: Vero SE Product Labeling

Bridgelux COB arrays have laser markings on the back side of the substrate to help with product identification. In addition to the product identification markings, Bridgelux COB arrays also contain markings for internal Bridgelux manufacturing use only. The image below shows which markings are for customer use and which ones are for Bridgelux internal use only. The Bridgelux internal manufacturing markings are subject to change without notice, however these will not impact the form, function or performance of the COB array.



Customer Use- 2D Barcode
Scannable barcode provides product part number and other Bridgelux internal production information.

Customer Use- Product part number

30E10K0C 73 2F

Customer Use- V, Bin Code included to enable greater luminaire design flexibility. Refer to ANg2 for bin definitions.

Design Resources

Application Notes

Bridgelux has developed a comprehensive set of application notes and design resources to assist customers in successfully designing with the Vero product family of LED array products. For all available application notes visit www.bridgelux.com.

Optical Source Models

Optical source models and ray set files are available for all Bridgelux products. For a list of available formats, visit www.bridgelux.com.

3D CAD Models

Three dimensional CAD models depicting the product outline of all Bridgelux Vero LED arrays are available in both IGS and STEP formats. Please contact your Bridgelux sales representative for assistance.

LM80

LM80 testing has been completed and the LM80 report is now available. Please contact your Bridgelux sales representative for LM-80 report.

Precautions

CAUTION: CHEMICAL EXPOSURE HAZARD

Exposure to some chemicals commonly used in luminaire manufacturing and assembly can cause damage to the LED array. Please consult Bridgelux Application Note AN120 for additional information.

CAUTION: RISK OF BURN

Do not touch the Vero LED array during operation. Allow the array to cool for a sufficient period of time before handling. The Vero LED array may reach elevated temperatures such that could burn skin when touched.

CAUTION

CONTACT WITH LIGHT EMITTING SURFACE (LES)

Avoid any contact with the LES. Do not touch the LES of the LED array or apply stress to the LES (yellow phosphor resin area). Contact may cause damage to the LED array.

Optics and reflectors must not be mounted in contact with the LES (yellow phosphor resin area). Optical devices may be mounted on the top surface of the plastic housing of the Vero LED array. Use the mechanical features of the LED array housing, edges and/or mounting holes to locate and secure optical devices as needed.

Disclaimers

MINOR PRODUCT CHANGE POLICY

The rigorous qualification testing on products offered by Bridgelux provides performance assurance. Slight cosmetic changes that do not affect form, fit, or function may occur as Bridgelux continues product optimization.

STANDARD TEST CONDITIONS

Unless otherwise stated, array testing is performed at the nominal drive current.

About Bridgelux: Bridging Light and Life™

At Bridgelux, we help companies, industries and people experience the power and possibility of light. Since 2002, we've designed LED solutions that are high performing, energy efficient, cost effective and easy to integrate. Our focus is on light's impact on human behavior, delivering products that create better environments, experiences and returns—both experiential and financial. And our patented technology drives new platforms for commercial and industrial luminaires.

For more information about the company, please visit
bridgelux.com
twitter.com/Bridgelux
facebook.com/Bridgelux
youtube.com/user/Bridgelux
linkedin.com/company/bridgelux-inc-_2
WeChat ID: BridgeluxInChina



46430 Fremont Boulevard
Fremont, CA 94538 U.S.A.
Tel (925) 583-8400
www.bridgelux.com

© 2016-2018 Bridgelux, Inc. All rights reserved 2018. Product specifications are subject to change without notice. Bridgelux, the Bridgelux stylized logo design, Vero, V Series and V Series HD are registered trademarks, and Decor Series is a trademark of Bridgelux, Inc. All other trademarks are the property of their respective owners.

Bridgelux Vero SE 29 Array Series Product Data Sheet DS123 Rev. K (11/2018)