



Bridgelux® Vero® SE 29 Array

Product Data Sheet DS123



Introduction

Vero SE



Vero® SE Series is a revolutionary light source system that integrates Bridgelux's seventh generation COB technology with poke-in connectivity enabling solder-free installation. Vero SE LED light sources streamline assembly processes, lower manufacturing cost, simplify luminaire design, improve light quality and increase design flexibility.

Vero SE is available in four different light emitting surface (LES) configurations that operate reliably over a broad current range. With Vero SE, secondary connector and holder components are not required, allowing for rapid integration of arrays into fixtures and an efficient field replaceable solution. Vero SE arrays deliver increased lumen density for improved beam control and precision lighting with 2 and 3 SDCM color control standards for clean and consistent uniform lighting.

Bridgelux Décor Series is our state of the art color line designed specifically for premium applications, producing unmatched LED light quality with brilliant color-rendering options and offer pleasing and inspiring lighting palettes. Bridgelux Décor Series color points are available on Vero® SE Series, Vero® Series, V Series™ and V Series™ HD.

Décor Series Class A is based on human response testing, providing color points with a combined GAI and CRI metric.

Décor Series™ Ultra products provide a high CRI of 97 and typical R9 value of 98, which emphasizes the reds and color tones to which the human eye is most receptive - perfect for the most luxurious retail shops and world renowned museums. Décor Series Ultra is designed as a replacement for halogen lamps

Décor Series™ Food products offer color points developed to address the unique requirements of the food, grocery, and restaurant industries. Highlighting the distinctive colors and nuanced patterns found in meats and breads, the Décor Series Food products are a must have for any butcher counter or bakery.

Décor Series™ Entertainment products provide color points developed specifically for the healthcare and entertainment industries. The 5600K cool white color point combined with a CRI of 90 or 97 provides the bright white required by these industries.

Décor Series™ Street and Landmark is designed to be a direct replacement for high pressure sodium lamps.

Features

- Poke-in connectivity
- Efficacy of 170 lm/W typical
- Lumen output performance ranges from 5,368 to 37,173 lumens
- Broad range of CCT options from 1750K to 6500K
- CRI options: minimum 65, 70, 80, and 90
- Color control: 2 and 3 SDCM for 2700K-4000K CCT
- Reliable operation at up to 2X nominal drive current
- Radial die pattern and improved lumen density
- Top side part number markings
- No exposed solder pads or electrical connections
- V_r bin code backside marking

Benefits

- Poke-in connectivity enables solderless, connector free installation
- Broad application coverage for interior and exterior lighting
- Flexibility for application driven lighting design requirements
- High quality, true color reproduction
- Uniform consistent white light
- Flexibility in design optimization
- Enhanced ease of use and assembly
- Ability to configure multiple arrays in series and parallel reduces customer driver cost
- Improved inventory management and quality control



Contents

Product Feature Map	2
Product Nomenclature	2
Product Selection Guide	3
Performance at Commonly Used Drive Currents	10
Electrical Characteristics	20
Eye Safety	21
Absolute Maximum Ratings	22
Performance Curves	23
Typical Radiation Pattern	27
Typical Color Spectrum	28
Mechanical Dimensions	29
Color Binning Information	30
Packaging and Labeling	31
Design Resources	33
Precautions	33
Disclaimers	33
About Bridgelux	34

Product Selection Guide

The following product configurations are available:

Table 1: Selection Guide, Pulsed Measurement Data ($T_j = T_c = 25^\circ\text{C}$)

Part Number	Nominal CCT ¹ (K)	CRI ²	Nominal Drive Current ³ (mA)	Typical Pulsed Flux ^{4,5,6} $T_c = 25^\circ\text{C}$ (lm)	Minimum Pulsed Flux ^{6,7} $T_c = 25^\circ\text{C}$ (lm)	Typical V_f (V)	Typical Power (W)	Typical Efficacy (lm/W)
BXRC-17E10K0-B-74-SE	1750	80	1800	8590	7731	52.0	93.6	92
BXRC-17E10K0-C-74-SE	1750	80	1710	10891	9802	69.4	118.7	92
BXRC-17E10K0-D-74-SE	1750	80	2100	7246	6522	37.6	79.0	92
BXRC-20B10K1-C-73-SE	2000	65	1710	18585	16727	69.4	118.7	157
BXRC-20B10K1-D-73-SE	2000	65	2100	12366	11129	37.6	79.0	157
BXRC-25E10K0-B-74-SE	2500	80	1800	14285	12856	52.0	93.6	153
BXRC-25E10K0-C-74-SE	2500	80	1710	18112	16301	69.4	118.7	153
BXRC-25E10K0-D-74-SE	2500	80	2100	12051	10846	37.6	79.0	153
BXRC-27E10K0-B-7x-SE	2700	80	1800	14939	13445	52.0	93.6	160
BXRC-27E10K0-C-7x-SE	2700	80	1710	18940	17046	69.4	118.7	160
BXRC-27E10K0-D-7x-SE	2700	80	2100	12602	11342	37.6	79.0	160
BXRC-27G1KH0-B-7x-SE	2700	90	1800	12791	11512	52.0	93.6	137
BXRC-27G1KH0-C-7x-SE	2700	90	1710	16218	14596	69.4	118.7	137
BXRC-27G1KH0-D-7x-SE	2700	90	2100	10790	9711	37.6	79.0	137
BXRC-27G10K0-B-7x-SE	2700	90	1800	12324	11092	52.0	93.6	132
BXRC-27G10K0-C-7x-SE	2700	90	1710	15626	14063	69.4	118.7	132
BXRC-27G10K0-D-7x-SE	2700	90	2100	10397	9357	37.6	79.0	132
BXRC-27H10K0-D-74-SE	2700	97	2100	9215	8294	37.6	79.0	117
BXRC-30C10K1-B-74-SE	3000	70	1800	16619	14957	52.0	93.6	178
BXRC-30C10K1-C-74-SE	3000	70	1710	21071	18964	69.4	118.7	178
BXRC-30C10K1-D-74-SE	3000	70	2100	14020	12618	37.6	79.0	178
BXRC-30E10K0-B-7x-SE ¹⁰	3000	80	1800	15872	14285	52.0	93.6	170
BXRC-30E10K0-C-7x-SE ¹⁰	3000	80	1710	20124	18112	69.4	118.7	170
BXRC-30E10K0-D-7x-SE ¹⁰	3000	80	2100	13390	12051	37.6	79.0	170
BXRC-30G1KH0-B-7x-SE	3000	90	1800	13445	12100	52.0	93.6	144
BXRC-30G1KH0-C-7x-SE	3000	90	1710	17046	15342	69.4	118.7	144
BXRC-30G1KH0-D-7x-SE	3000	90	2100	11342	10208	37.6	79.0	144
BXRC-30G10K0-B-7x-SE	3000	90	1800	12885	11596	52.0	93.6	138
BXRC-30G10K0-C-7x-SE	3000	90	1710	16336	14702	69.4	118.7	138
BXRC-30G10K0-D-7x-SE	3000	90	2100	10869	9782	37.6	79.0	138
BXRC-30H10K0-D-7x-SE	3000	97	2100	9845	8861	37.6	79.0	125
BXRC-30A10K1-B-73-SE ^{8,9}	3000	93	1800	11577	10420	52.0	93.6	124
BXRC-30A10K1-C-73-SE ^{8,9}	3000	93	1710	14679	13211	69.4	118.7	124
BXRC-30A10K1-D-73-SE ^{8,9}	3000	93	2100	9767	8790	37.6	79.0	124

Notes for Table 1:

- Nominal CCT as defined by ANSI C78.377-2011. Products with a CCT of 5000K-6500K are hot targeted to $T_c = 85^\circ\text{C}$.
- All CRI values are measured at $T_j = T_c = 25^\circ\text{C}$. CRI values are typical for Decor Series Ultra, Decor Series Street and Landmark and Decor Series Class A products. CRI values are minimums for all other products. Minimum Rg value for 80 CRI products is 0, the minimum Rg values for 90 CRI products is 50, the minimum Rg values for 97 CRI products is 93. Bridgelux maintains a ± 3 tolerance on CRI and Rg values.
- Drive current is referred to as nominal drive current.
- Products tested under pulsed condition (10ms pulse width) at nominal test current where T_j (junction temperature) = T_c (case temperature) = 25°C .
- Typical performance values are provided as a reference only and are not a guarantee of performance.
- Bridgelux maintains a $\pm 7\%$ tolerance on flux measurements.
- Minimum flux values at the nominal test current are guaranteed by 100% test.
- Nominal CCT is defined by the Lighting Research Center's Class A definition. The center of the Class A color bin is on the corresponding isothermal line.
- GAI value is 80. To help ensure optimal fixture level performance, GAI is measured at the fixture level, on axis, at a case temperature of 70°C . GAI may vary depending on fixture design and performance.
- SKUs meet DLC premium (Outdoor Mid Output) requirements under certain system level conditions.

Product Selection Guide

Table 1: Selection Guide, Pulsed Measurement Data ($T_j = T_c = 25^\circ\text{C}$) (continued)

Part Number	Nominal CCT ¹ (K)	CRI ²	Nominal Drive Current ³ (mA)	Typical Pulsed Flux ^{4,5,6} $T_c = 25^\circ\text{C}$ (lm)	Minimum Pulsed Flux ^{6,7} $T_c = 25^\circ\text{C}$ (lm)	Typical V_f (V)	Typical Power (W)	Typical Efficacy (lm/W)
BXRC-35E10K0-B-7x-SE ¹⁰	3500	80	1800	16246	14621	52.0	93.6	174
BXRC-35E10K0-C-7x-SE ¹⁰	3500	80	1710	20598	18538	69.4	118.7	174
BXRC-35E10K0-D-7x-SE ¹⁰	3500	80	2100	13705	12334	37.6	79.0	174
BXRC-35G10K0-B-7x-SE	3500	90	1800	13351	12016	52.0	93.6	143
BXRC-35G10K0-C-7x-SE	3500	90	1710	16928	15235	69.4	118.7	143
BXRC-35G10K0-D-7x-SE	3500	90	2100	11263	10137	37.6	79.0	143
BXRC-35A10K1-B-73-SE ^{8,9}	3500	93	1800	12324	11092	52.0	93.6	132
BXRC-35A10K1-C-73-SE ^{8,9}	3500	93	1710	15626	14063	69.4	118.7	132
BXRC-35A10K1-D-73-SE ^{8,9}	3500	93	2100	10397	9357	37.6	79.0	132
BXRC-40C10K1-B-74-SE	4000	70	1800	17086	15377	52.0	93.6	183
BXRC-40C10K1-C-74-SE	4000	70	1710	21663	19497	69.4	118.7	183
BXRC-40C10K1-D-74-SE	4000	70	2100	14414	12972	37.6	79.0	183
BXRC-40E10K0-B-7x-SE ¹⁰	4000	80	1800	16339	14705	52.0	93.6	175
BXRC-40E10K0-C-7x-SE ¹⁰	4000	80	1710	20716	18644	69.4	118.7	175
BXRC-40E10K0-D-7x-SE ¹⁰	4000	80	2100	13783	12405	37.6	79.0	175
BXRC-40G10K0-B-7x-SE	4000	90	1800	13631	12268	52.0	93.6	146
BXRC-40G10K0-C-7x-SE	4000	90	1710	17283	15555	69.4	118.7	146
BXRC-40G10K0-D-7x-SE	4000	90	2100	11499	10349	37.6	79.0	146
BXRC-40H10K0-D-7x-SE	4000	97	2100	10397	9357	37.6	79.0	132
BXRC-40A10K1-B-73-SE ^{8,9}	4000	93	1800	13351	12016	52.0	93.6	143
BXRC-40A10K1-C-73-SE ^{8,9}	4000	93	1710	16928	15235	69.4	118.7	143
BXRC-40A10K1-D-73-SE ^{8,9}	4000	93	2100	11263	10137	37.6	79.0	143
BXRC-50C10K1-B-7x-SE ¹⁰	5000	70	1800	17179	15461	52.0	93.6	184
BXRC-50C10K1-C-7x-SE ¹⁰	5000	70	1710	21781	19603	69.4	118.7	184
BXRC-50C10K1-D-7x-SE ¹⁰	5000	70	2100	14492	13043	37.6	79.0	184
BXRC-50E10K1-B-7x-SE ¹⁰	5000	80	1800	16526	14873	52.0	93.6	177
BXRC-50E10K1-C-7x-SE ¹⁰	5000	80	1710	20953	18858	69.4	118.7	177
BXRC-50E10K1-D-7x-SE ¹⁰	5000	80	2100	13941	12547	37.6	79.0	177
BXRC-50G10K1-B-7x-SE	5000	90	1800	14285	12856	52.0	93.6	153
BXRC-50G10K1-C-74-SE	5000	90	1710	18112	16301	69.4	118.7	153
BXRC-50G10K1-D-74-SE	5000	90	2100	12051	10846	37.6	79.0	153
BXRC-56G10K0-B-74-SE	5600	80	1800	14378	12941	52.0	93.6	154

Notes for Table 1:

- Nominal CCT as defined by ANSI C78.377-2011. Products with a CCT of 5000K-6500K are hot targeted to $T_c = 85^\circ\text{C}$.
- All CRI values are measured at $T_j = T_c = 25^\circ\text{C}$. CRI values are typical for Decor Series Ultra, Decor Series Street and Landmark and Decor Series Class A products. CRI values are minimums for all other products. Minimum Rg value for 80 CRI products is 0, the minimum Rg values for 90 CRI products is 50, the minimum Rg values for 97 CRI products is 93. Bridgelux maintains a ± 3 tolerance on CRI and Rg values.
- Drive current is referred to as nominal drive current.
- Products tested under pulsed condition (10ms pulse width) at nominal test current where T_j (junction temperature) = T_c (case temperature) = 25°C .
- Typical performance values are provided as a reference only and are not a guarantee of performance.
- Bridgelux maintains a $\pm 7\%$ tolerance on flux measurements.
- Minimum flux values at the nominal test current are guaranteed by 100% test.
- Nominal CCT is defined by the Lighting Research Center's Class A definition. The center of the Class A color bin is on the corresponding isothermal line.
- GAI value is 80. To help ensure optimal fixture level performance, GAI is measured at the fixture level, on axis, at a case temperature of 70°C . GAI may vary depending on fixture design and performance.
- SKUs meet DLC premium (Outdoor Mid Output) requirements under certain system level conditions.

Product Selection Guide

Table 1: Selection Guide, Pulsed Measurement Data ($T_j = T_c = 25^\circ\text{C}$) (continued)

Part Number	Nominal CCT ¹ (K)	CRI ²	Nominal Drive Current ³ (mA)	Typical Pulsed Flux ^{4,5,6} $T_c = 25^\circ\text{C}$ (lm)	Minimum Pulsed Flux ^{6,7} $T_c = 25^\circ\text{C}$ (lm)	Typical V_f (V)	Typical Power (W)	Typical Efficacy (lm/W)
BXRC-56G10K0-C-74-SE	5600	80	1710	18230	16407	69.4	118.7	154
BXRC-56G10Kx-D-74-SE	5600	80	2100	12129	10916	37.6	79.0	154
BXRC-56H10K0-D-74-SE	5600	97	2100	10948	9853	37.6	79.0	139
BXRC-57C10K1-B-74-SE	5700	70	1800	16713	15041	52.0	93.6	179
BXRC-57C10K1-C-74-SE	5700	70	1710	21190	19071	69.4	118.7	179
BXRC-57C10K1-D-74-SE	5700	70	2100	14099	12689	37.6	79.0	179
BXRC-57E10K1-B-74-SE	5700	80	1800	15872	14285	52.0	93.6	170
BXRC-57E10K1-C-74-SE	5700	80	1710	20124	18112	69.4	118.7	170
BXRC-57E10K1-D-74-SE	5700	80	2100	13390	12051	37.6	79.0	170
BXRC-65C10K1-B-74-SE	6500	70	1800	16713	15041	52.0	93.6	179
BXRC-65C10K1-C-74-SE	6500	70	1710	21190	19071	69.4	118.7	179
BXRC-65C10K1-D-74-SE	6500	70	2100	14099	12689	37.6	79.0	179
BXRC-65E10K1-B-74-SE	6500	80	1800	16059	14453	52.0	93.6	172
BXRC-65E10K1-C-74-SE	6500	80	1710	20361	18325	69.4	118.7	172
BXRC-65E10K1-D-74-SE	6500	80	2100	13547	12192	37.6	79.0	172

Notes for Table 1:

- Nominal CCT as defined by ANSI C78.377-2011. Products with a CCT of 5000K-6500K are hot targeted to $T_c = 85^\circ\text{C}$.
- All CRI values are measured at $T_j = T_c = 25^\circ\text{C}$. CRI values are typical for Decor Series Ultra, Decor Series Street and Landmark and Decor Series Class A products. CRI values are minimums for all other products. Minimum Rg value for 80 CRI products is 0, the minimum Rg values for 90 CRI products is 50, the minimum Rg values for 97 CRI products is 93. Bridgelux maintains a ± 3 tolerance on CRI and Rg values.
- Drive current is referred to as nominal drive current.
- Products tested under pulsed condition (10ms pulse width) at nominal test current where T_j (junction temperature) = T_c (case temperature) = 25°C .
- Typical performance values are provided as a reference only and are not a guarantee of performance.
- Bridgelux maintains a $\pm 7\%$ tolerance on flux measurements.
- Minimum flux values at the nominal test current are guaranteed by 100% test.
- Nominal CCT is defined by the Lighting Research Center's Class A definition. The center of the Class A color bin is on the corresponding isothermal line.
- GAI value is 80. To help ensure optimal fixture level performance, GAI is measured at the fixture level, on axis, at a case temperature of 70°C . GAI may vary depending on fixture design and performance.
- SKUs meet DLC premium (Outdoor Mid Output) requirements under certain system level conditions.

Product Selection Guide

Table 2: Selection Guide, Stabilized DC Performance ($T_c = 70^\circ\text{C}$) ^{7,8}

Part Number	Nominal CCT ¹ (K)	GAI ²	CRI ³	Nominal Drive Current ⁴ (mA)	Typical DC Flux ^{5,6} $T_c = 70^\circ\text{C}$ (lm)	Minimum DC Flux ^{6,9} $T_c = 70^\circ\text{C}$ (lm)	Typical V_f (V)	Typical Power (W)	Typical Efficacy (lm/W)
BXRC-30A10K1-B-73-SE	3000	80	93	1800	10767	9690	50.9	91.6	118
BXRC-30A10K1-C-73-SE	3000	80	93	1710	13651	12286	67.9	116.1	118
BXRC-30A10K1-D-73-SE	3000	80	93	2100	9083	8175	36.8	77.3	118
BXRC-35A10K1-B-73-SE	3500	80	93	1800	11462	10315	50.9	91.6	125
BXRC-35A10K1-C-73-SE	3500	80	93	1710	14532	13079	67.9	116.1	125
BXRC-35A10K1-D-73-SE	3500	80	93	2100	9669	8702	36.8	77.3	125
BXRC-40A10K1-B-73-SE	4000	80	93	1800	12417	11175	50.9	91.6	136
BXRC-40A10K1-C-73-SE	4000	80	93	1710	15743	14169	67.9	116.1	136
BXRC-40A10K1-D-73-SE	4000	80	93	2100	10475	9427	36.8	77.3	136

Notes for Table 2:

1. Nominal CCT is defined by the Lighting Research Center's Class A definition. The center of the Class A color bin is on the corresponding isothermal line.
2. To help ensure optimal fixture level performance, GAI is measured at the fixture level, on axis, at a case temperature of 70°C . GAI may vary depending on fixture design and performance.
3. CRI Values are specified as typical.
4. Drive current is referred to as nominal drive current.
5. Typical performance values are provided as a reference only and are not a guarantee of performance.
6. Bridgelux maintains a $\pm 7\%$ tolerance on flux measurements.
7. Typical stabilized DC performance values are provided as reference only and are not a guarantee of performance.
8. Typical performance is estimated based on operation under DC (direct current) with LED array mounted onto a heat sink with thermal interface material and the case temperature maintained at specified temperature. Based on Bridgelux test setup, values may vary depending on the thermal design of the luminaire and/or the exposed environment to which the product is subjected.
9. Minimum flux values at elevated temperatures are provided for reference only and are not guaranteed by 100% production testing. Based on Bridgelux test setup, values may vary depending on the thermal design of the luminaire and/or the exposed environment to which the product is subjected.

Product Selection Guide

Table 3: Selection Guide, Stabilized DC Performance ($T_c = 85^\circ\text{C}$)^{4,5}

Part Number	Nominal CCT ¹ (K)	CRI ²	Nominal Drive Current ³ (mA)	Typical DC Flux ^{4,5} $T_c = 85^\circ\text{C}$ (lm)	Minimum DC Flux ⁶ $T_c = 85^\circ\text{C}$ (lm)	Typical V_f (V)	Typical Power (W)	Typical Efficacy (lm/W)
BXRC-17E10K0-B-74-SE	1750	80	1800	7731	6958	50.7	91.2	85
BXRC-17E10K0-C-74-SE	1750	80	1710	9802	8821	68.1	116.4	84
BXRC-17E10K0-D-74-SE	1750	80	2100	6522	5869	36.6	76.8	85
BXRC-20B10K1-C-73-SE	2000	65	1710	16727	15054	68.1	116.4	144
BXRC-20B10K1-D-73-SE	2000	65	2100	11129	10016	36.6	76.8	145
BXRC-25E10K0-B-74-SE	2500	80	1800	12856	11571	50.7	91.2	141
BXRC-25E10K0-C-74-SE	2500	80	1710	16301	14671	68.1	116.4	140
BXRC-25E10K0-D-74-SE	2500	80	2100	10846	9761	36.6	76.8	141
BXRC-27E10K0-B-7X-SE	2700	80	1800	13445	12100	50.7	91.2	147
BXRC-27E10K0-C-7X-SE	2700	80	1710	17046	15342	68.1	116.4	146
BXRC-27E10K0-D-7X-SE	2700	80	2100	11342	10208	36.6	76.8	148
BXRC-27G1KH0-B-7X-SE	2700	90	1800	11512	10361	50.7	91.2	126
BXRC-27G1KH0-C-7X-SE	2700	90	1710	14596	13136	68.1	116.4	125
BXRC-27G1KH0-D-7X-SE	2700	90	2100	9711	8740	36.6	76.8	127
BXRC-27G10K0-B-7X-SE	2700	90	1800	11092	9983	50.7	91.2	122
BXRC-27G10K0-C-7X-SE	2700	90	1710	14063	12657	68.1	116.4	121
BXRC-27G10K0-D-7X-SE	2700	90	2100	9357	8421	36.6	76.8	122
BXRC-27H10K0-D-74-SE	2700	97	2100	8294	7464	36.6	76.9	108
BXRC-30C10K1-B-74-SE	3000	70	1800	14957	13462	50.7	91.2	164
BXRC-30C10K1-C-74-SE	3000	70	1710	18964	17068	68.1	116.4	163
BXRC-30C10K1-D-74-SE	3000	70	2100	12618	11356	36.6	76.8	164
BXRC-30E10K0-B-7X-SE	3000	80	1800	14285	12856	50.7	91.2	157
BXRC-30E10K0-C-7X-SE	3000	80	1710	18112	16301	68.1	116.4	156
BXRC-30E10K0-D-7X-SE	3000	80	2100	12051	10846	36.6	76.8	157
BXRC-30G1KH0-B-7X-SE	3000	90	1800	12100	10890	50.7	91.2	133
BXRC-30G1KH0-C-7X-SE	3000	90	1710	15342	13808	68.1	116.4	132
BXRC-30G1KH0-D-7X-SE	3000	90	2100	10208	9187	36.6	76.8	133
BXRC-30G10K0-B-7X-SE	3000	90	1800	11596	10436	50.7	91.2	127
BXRC-30G10K0-C-7X-SE	3000	90	1710	14702	13232	68.1	116.4	126
BXRC-30G10K0-D-7X-SE	3000	90	2100	9782	8804	36.6	76.8	127
BXRC-30H10K0-D-7X-SE	3000	97	2100	8861	7975	36.6	76.8	115
BXRC-30A10K1-B-73-SE ^{7,8}	3000	93	1800	10420	9378	50.7	91.2	114
BXRC-30A10K1-C-73-SE ^{7,8}	3000	93	1710	13211	11890	68.1	116.4	113
BXRC-30A10K1-D-73-SE ^{7,8}	3000	93	2100	8790	7911	36.6	76.8	114

Notes for Table 3:

- Nominal CCT as defined by ANSI C78 377-2011. Products with a CCT of 5000K-6500K are hot targeted to $T_c = 85^\circ\text{C}$.
- All CRI values are measured at $T_c = 25^\circ\text{C}$. CRI values are typical for Decor Series Ultra, Decor Series Street and Landmark and Decor Series Class A products. CRI values are minimums for all other products. Minimum Rg value for 80 CRI products is 0, the minimum Rg values for 90 CRI products is 50, the minimum Rg values for 97 CRI products is 93. Bridgelux maintains a ± 3 tolerance on CRI and Rg values.
- Drive current is referred to as nominal drive current.
- Typical stabilized DC performance values are provided as reference only and are not a guarantee of performance.
- Typical performance is estimated based on operation under DC (direct current) with LED array mounted onto a heat sink with thermal interface material and the case temperature maintained at 85°C . Based on Bridgelux test setup, values may vary depending on the thermal design of the luminaire and/or the exposed environment to which the product is subjected.
- Minimum flux values at elevated temperatures are provided for reference only and are not guaranteed by 100% production testing. Based on Bridgelux test setup, values may vary depending on the thermal design of the luminaire and/or the exposed environment to which the product is subjected.
- Nominal CCT is defined by the Lighting Research Center's Class A definition. The center of the Class A color bin is on the corresponding isothermal line.
- GAI value is 80. To help ensure optimal fixture level performance, GAI is measured at the fixture level, on axis, at a case temperature of 70°C . GAI may vary depending on fixture design and performance.

Product Selection Guide

Table 3: Selection Guide, Stabilized DC Performance ($T_c = 85^\circ\text{C}$)⁴⁵ (continued)

Part Number	Nominal CCT ¹ (K)	CRI ²	Nominal Drive Current ³ (mA)	Typical DC Flux ^{4,5} $T_c = 85^\circ\text{C}$ (lm)	Minimum DC Flux ⁶ $T_c = 85^\circ\text{C}$ (lm)	Typical V_f (V)	Typical Power (W)	Typical Efficacy (lm/W)
BXRC-35E10K0-B-7x-SE	3500	80	1800	14621	13159	50.7	91.2	160
BXRC-35E10K0-C-7x-SE	3500	80	1710	18538	16684	68.1	116.4	159
BXRC-35E10K0-D-7x-SE	3500	80	2100	12334	11101	36.6	76.8	161
BXRC-35G10K0-B-7x-SE	3500	90	1800	12016	10815	50.7	91.2	132
BXRC-35G10K0-C-7x-SE	3500	90	1710	15235	13712	68.1	116.4	131
BXRC-35G10K0-D-7x-SE	3500	90	2100	10137	9123	36.6	76.8	132
BXRC-35A10K1-B-73-SE ^{7,8}	3500	93	1800	11092	9983	50.7	91.2	122
BXRC-35A10K1-C-73-SE ^{7,8}	3500	93	1710	14063	12657	68.1	116.4	121
BXRC-35A10K1-D-73-SE ^{7,8}	3500	93	2100	9357	8421	36.6	76.8	122
BXRC-40C10K1-B-74-SE	4000	70	1800	15377	13840	50.7	91.2	169
BXRC-40C10K1-C-74-SE	4000	70	1710	19497	17547	68.1	116.4	167
BXRC-40C10K1-D-74-SE	4000	70	2100	12972	11675	36.6	76.8	169
BXRC-40E10K0-B-7x-SE	4000	80	1800	14705	13235	50.7	91.2	161
BXRC-40E10K0-C-7x-SE	4000	80	1710	18644	16780	68.1	116.4	160
BXRC-40E10K0-D-7x-SE	4000	80	2100	12405	11165	36.6	76.8	162
BXRC-40G10K0-B-7x-SE	4000	90	1800	12268	11041	50.7	91.2	135
BXRC-40G10K0-C-7x-SE	4000	90	1710	15555	13999	68.1	116.4	134
BXRC-40G10K0-D-7x-SE	4000	90	2100	10349	9314	36.6	76.8	135
BXRC-40H10K0-D-7x-SE	4000	97	2100	9357	8421	36.6	76.8	122
BXRC-40A10K1-B-73-SE ^{7,8}	4000	93	1800	12016	10815	50.7	91.2	132
BXRC-40A10K1-C-73-SE ^{7,8}	4000	93	1710	15235	13712	68.1	116.4	131
BXRC-40A10K1-D-73-SE ^{7,8}	4000	93	2100	10137	9123	36.6	76.8	132
BXRC-50C10K1-B-7x-SE	5000	70	1800	15461	13915	50.7	91.2	170
BXRC-50C10K1-C-7x-SE	5000	70	1710	19603	17643	68.1	116.4	168
BXRC-50C10K1-D-7x-SE	5000	70	2100	13043	11739	36.6	76.8	170
BXRC-50E10K1-B-7x-SE	5000	80	1800	14873	13386	50.7	91.2	163
BXRC-50E10K1-C-7x-SE	5000	80	1710	18858	16972	68.1	116.4	162
BXRC-50E10K1-D-7x-SE	5000	80	2100	12547	11292	36.6	76.8	163
BXRC-50G10K1-B-7x-SE	5000	90	1800	12856	11571	50.7	91.2	141
BXRC-50G10K1-C-7x-SE	5000	90	1710	16301	14671	68.1	116.4	140
BXRC-50G10K1-D-7x-SE	5000	90	2100	10846	9761	36.6	76.8	141
BXRC-56G10K1-B-74-SE	5600	80	1800	12941	11646	50.7	91.2	142
BXRC-56G10K1-C-74-SE	5600	80	1710	16407	14766	68.1	116.4	141
BXRC-56G10Kx-D-74-SE	5600	80	2100	10916	9825	36.6	76.8	142
BXRC-56H10K0-D-74-SE	5600	97	2100	9853	8868	36.6	76.8	128

Notes for Table 3:

- Nominal CCT as defined by ANSI C78.377-2011. Products with a CCT of 5000K-6500K are hot targeted to $T_c = 85^\circ\text{C}$.
- All CRI values are measured at $T_1 - T_c = 25^\circ\text{C}$. CRI values are typical for Decor Series Ultra, Decor Series Street and Landmark and Decor Series Class A products. CRI values are minimums for all other products. Minimum Rg value for 80 CRI products is 0, the minimum Rg values for 90 CRI products is 50, the minimum Rg values for 97 CRI products is 93. Bridgelux maintains a ± 3 tolerance on CRI and Rg values.
- Drive current is referred to as nominal drive current.
- Typical stabilized DC performance values are provided as reference only and are not a guarantee of performance.
- Typical performance is estimated based on operation under DC (direct current) with LED array mounted onto a heat sink with thermal interface material and the case temperature maintained at 85°C . Based on Bridgelux test setup, values may vary depending on the thermal design of the luminaire and/or the exposed environment to which the product is subjected.
- Minimum flux values at elevated temperatures are provided for reference only and are not guaranteed by 100% production testing. Based on Bridgelux test setup, values may vary depending on the thermal design of the luminaire and/or the exposed environment to which the product is subjected.
- Nominal CCT is defined by the Lighting Research Center's Class A definition. The center of the Class A color bin is on the corresponding isothermal line.
- GAI value is 80. To help ensure optimal fixture level performance, GAI is measured at the fixture level, on axis, at a case temperature of 70°C . GAI may vary depending on fixture design and performance.

Product Selection Guide

Table 3: Selection Guide, Stabilized DC Performance ($T_c = 85^\circ\text{C}$)^{4,5} (continued)

Part Number	Nominal CCT ¹ (K)	CRI ²	Nominal Drive Current ³ (mA)	Typical DC Flux ^{4,5} $T_c = 85^\circ\text{C}$ (lm)	Minimum DC Flux ⁶ $T_c = 85^\circ\text{C}$ (lm)	Typical V_f (V)	Typical Power (W)	Typical Efficacy (lm/W)
BXRC-57C10K1-B-7x-SE	5700	70	1800	15041	13537	50.7	91.2	165
BXRC-57C10K1-C-7x-SE	5700	70	1710	19071	17164	68.1	116.4	164
BXRC-57C10K1-D-7x-SE	5700	70	2100	12689	11420	36.6	76.8	165
BXRC-57E10K1-B-7x-SE	5700	80	1800	14285	12856	50.7	91.2	157
BXRC-57E10K1-C-7x-SE	5700	80	1710	18112	16301	68.1	116.4	156
BXRC-57E10K1-D-7x-SE	5700	80	2100	12051	10846	36.6	76.8	157
BXRC-65C10K1-B-7x-SE	6500	70	1800	15041	13537	50.7	91.2	165
BXRC-65C10K1-C-7x-SE	6500	70	1710	19071	17164	68.1	116.4	164
BXRC-65C10K1-D-7x-SE	6500	70	2100	12689	11420	36.6	76.8	165
BXRC-65E10K1-B-7x-SE	6500	80	1800	14453	13008	50.7	91.2	158
BXRC-65E10K1-C-7x-SE	6500	80	1710	18325	16492	68.1	116.4	157
BXRC-65E10K1-D-7x-SE	6500	80	2100	12192	10973	36.6	76.8	159

Notes for Table 3:

- Nominal CCT as defined by ANSI C78.377-2011. Products with a CCT of 5000K-6500K are hot targeted to $T_c = 85^\circ\text{C}$.
- All CRI values are measured at $T_s = T_c = 25^\circ\text{C}$. CRI values are typical for Decor Series Ultra, Decor Series Street and Landmark and Decor Series Class A products. CRI values are minimums for all other products. Minimum R_g value for 80 CRI products is 0, the minimum R_g values for 90 CRI products is 50, the minimum R_g values for 97 CRI products is 93. Bridgelux maintains a ± 3 tolerance on CRI and R_g values.
- Drive current is referred to as nominal drive current.
- Typical stabilized DC performance values are provided as reference only and are not a guarantee of performance.
- Typical performance is estimated based on operation under DC (direct current) with LED array mounted onto a heat sink with thermal interface material and the case temperature maintained at 85°C . Based on Bridgelux test setup, values may vary depending on the thermal design of the luminaire and/or the exposed environment to which the product is subjected.
- Minimum flux values at elevated temperatures are provided for reference only and are not guaranteed by 100% production testing. Based on Bridgelux test setup, values may vary depending on the thermal design of the luminaire and/or the exposed environment to which the product is subjected.
- Nominal CCT is defined by the Lighting Research Center's Class A definition. The center of the Class A color bin is on the corresponding isothermal line.
- GAI value is 80. To help ensure optimal fixture level performance, GAI is measured at the fixture level, on axis, at a case temperature of 70°C . GAI may vary depending on fixture design and performance.

Performance at Commonly Used Drive Currents

Vero SE LED arrays are tested to the specifications shown using the nominal drive currents in Table 1. Vero SE may also be driven at other drive currents dependent on specific application design requirements. The performance at any drive current can be derived from the current vs. voltage characteristics shown in Figures 1, 2 & 3 and the flux vs. current characteristics shown in Figures 4, 5 & 6. The performance at commonly used drive currents is summarized in Table 4.

Table 4: Product Performance at Commonly Used Drive Currents

Part Number	CRI	Drive Current ¹ (mA)	Typical V_f $T_c = 25^\circ\text{C}$ (V)	Typical Power $T_c = 25^\circ\text{C}$ (W)	Typical Flux ² $T_c = 25^\circ\text{C}$ (lm)	Typical DC Flux ³ $T_c = 85^\circ\text{C}$ (lm)	Typical Efficacy $T_c = 25^\circ\text{C}$ (lm/W)
BXRC-17E10K0-B-74-SE	80	900	49.6	44.7	4459	4070	100
		1200	50.5	60.6	5871	5337	97
		1800	52.0	93.6	8590	7731	92
		2700	54.1	146.1	12382	11042	85
		3600	55.8	201.0	15847	13963	79
BXRC-17E10K0-C-74-SE	80	855	66.2	56.6	6187	5887	109
		1140	67.3	76.7	7863	7253	103
		1710	69.4	118.7	10891	9802	92
		2565	72.1	185.0	15450	13288	84
		3420	74.4	254.6	19365	16272	76
BXRC-17E10K0-D-74-SE	80	1050	35.4	37.2	3986	3884	107
		1400	36.2	50.6	5130	4774	101
		2100	37.6	79.0	7246	6522	92
		3150	39.5	124.4	10316	8692	83
		4200	41.2	172.9	13002	10617	75
BXRC-20B10K1-C-73-SE	65	855	66.2	56.6	10558	10047	187
		1140	67.3	76.7	13419	12378	175
		1710	69.4	118.7	18585	16727	157
		2565	72.1	185.0	26365	22676	143
		3420	74.4	254.6	33047	27768	130
BXRC-20B10K1-D-73-SE	65	1050	35.4	37.2	6802	6627	183
		1400	36.2	50.6	8754	8147	173
		2100	37.6	79.0	12366	11129	157
		3150	39.5	124.4	17604	14833	142
		4200	41.2	172.9	22188	18118	128
BXRC-25E10K0-B-74-SE	80	900	49.6	44.7	7416	6769	166
		1200	50.5	60.6	9764	8876	161
		1800	52.0	93.6	14285	12856	153
		2700	54.1	146.1	20592	18364	141
		3600	55.8	201.0	26355	23221	131
BXRC-25E10K0-C-74-SE	80	855	66.2	56.6	10289	9791	182
		1140	67.3	76.7	13077	12063	170
		1710	69.4	118.7	18112	16301	153
		2565	72.1	185.0	25694	22099	139
		3420	74.4	254.6	32205	27061	127
BXRC-25E10K0-D-74-SE	80	1050	35.4	37.2	6628	6459	178
		1400	36.2	50.6	8531	7939	168
		2100	37.6	79.0	12051	10846	153
		3150	39.5	124.4	17156	14455	138
		4200	41.2	172.9	21623	17657	125

Notes for Table 4:

1. Alternate drive currents are provided for reference only and are not a guarantee of performance.
2. Bridgelux maintains a $\pm 7\%$ tolerance on flux measurements.
3. Typical stabilized DC performance values are provided as reference only and are not a guarantee of performance.

Performance at Commonly Used Drive Currents

Table 4: Product Performance at Commonly Used Drive Currents (Continued)

Part Number	CRI	Drive Current ¹ (mA)	Typical V _f T _c = 25°C (V)	Typical Power T _c = 25°C (W)	Typical Flux ² T _c = 25°C (lm)	Typical DC Flux ³ T _c = 85°C (lm)	Typical Efficacy T _c = 25°C (lm/W)
BXRC-27E10K0-B-7x-SE	80	900	49.6	44.7	7755	7079	174
		1200	50.5	60.6	10211	9282	169
		1800	52.0	93.6	14939	13445	160
		2700	54.1	146.1	21534	19204	147
		3600	55.8	201.0	27561	24283	137
BXRC-27E10K0-C-7x-SE	80	855	66.2	56.6	10759	10239	190
		1140	67.3	76.7	13675	12615	178
		1710	69.4	118.7	18940	17046	160
		2565	72.1	185.0	26869	23110	145
		3420	74.4	254.6	33678	28299	132
BXRC-27E10K0-D-7x-SE	80	1050	35.4	37.2	6932	6754	186
		1400	36.2	50.6	8921	8302	176
		2100	37.6	79.0	12602	11342	160
		3150	39.5	124.4	17941	15117	144
		4200	41.2	172.9	22612	18464	131
BXRC-27G1KH0-B-7x-SE	90	900	49.6	44.7	6640	6061	149
		1200	50.5	60.6	8743	7948	144
		1800	52.0	93.6	12791	11512	137
		2700	54.1	146.1	18438	16444	126
		3600	55.8	201.0	23599	20792	117
BXRC-27G1KH0-C-7x-SE	90	855	66.2	56.6	9213	8767	163
		1140	67.3	76.7	11709	10801	153
		1710	69.4	118.7	16218	14596	137
		2565	72.1	185.0	23007	19788	124
		3420	74.4	254.6	28837	24231	113
BXRC-27G1KH0-D-7x-SE	90	1050	35.4	37.2	5935	5783	160
		1400	36.2	50.6	7639	7109	151
		2100	37.6	79.0	10790	9711	137
		3150	39.5	124.4	15362	12944	124
		4200	41.2	172.9	19361	15810	112
BXRC-27G10K0-B-7x-SE	90	900	49.6	44.7	6398	5840	143
		1200	50.5	60.6	8424	7658	139
		1800	52.0	93.6	12324	11092	132
		2700	54.1	146.1	17765	15843	122
		3600	55.8	201.0	22738	20033	113
BXRC-27G10K0-C-7x-SE	90	855	66.2	56.6	8877	8447	157
		1140	67.3	76.7	11282	10407	147
		1710	69.4	118.7	15626	14063	132
		2565	72.1	185.0	22167	19065	120
		3420	74.4	254.6	27784	23347	109
BXRC-27G10K0-D-7x-SE	90	1050	35.4	37.2	5719	5572	154
		1400	36.2	50.6	7360	6849	145
		2100	37.6	79.0	10397	9357	132
		3150	39.5	124.4	14801	12471	119
		4200	41.2	172.9	18655	15233	108

Notes for Table 4:

1. Alternate drive currents are provided for reference only and are not a guarantee of performance.
2. Bridgelux maintains a ± 7% tolerance on flux measurements.
3. Typical stabilized DC performance values are provided as reference only and are not a guarantee of performance.

Performance at Commonly Used Drive Currents

Table 4: Product Performance at Commonly Used Drive Currents (Continued)

Part Number	CRI	Drive Current ¹ (mA)	Typical V _f T _c = 25°C (V)	Typical Power T _c = 25°C (W)	Typical Flux ² T _c = 25°C (lm)	Typical DC Flux ³ T _c = 85°C (lm)	Typical Efficacy T _c = 25°C (lm/W)
BXRC-27H10K0-D-74-SE	97	1050	35.4	37.2	5069	4939	136
		1400	36.2	50.6	6523	6071	129
		2100	37.6	79.0	9215	8294	117
		3150	39.5	124.4	13119	11054	105
		4200	41.2	172.9	16535	13502	96
BXRC-30C10K1-B-74-SE	70	900	49.6	44.7	9441	8984	211
		1200	50.5	60.6	11999	11069	198
		1800	52.0	93.6	16619	14957	178
		2700	54.1	146.1	23576	20277	161
		3600	55.8	201.0	29551	24831	147
BXRC-30C10K1-C-74-SE	70	855	66.2	56.6	11590	11293	205
		1140	67.3	76.7	14916	13882	194
		1710	69.4	118.7	21071	18964	178
		2565	72.1	185.0	29998	25276	162
		3420	74.4	254.6	37808	30873	149
BXRC-30C10K1-D-74-SE	70	1050	35.4	37.2	7712	7514	207
		1400	36.2	50.6	9925	9236	196
		2100	37.6	79.0	14020	12618	178
		3150	39.5	124.4	19959	16817	160
		4200	41.2	172.9	25156	20542	145
BXRC-30E10K0-B-7x-SE	80	900	49.6	44.7	8240	7521	184
		1200	50.5	60.6	10849	9862	179
		1800	52.0	93.6	15872	14285	170
		2700	54.1	146.1	22879	20404	157
		3600	55.8	201.0	29283	25801	146
BXRC-30E10K0-C-7x-SE	80	855	66.2	56.6	11432	10878	202
		1140	67.3	76.7	14530	13403	189
		1710	69.4	118.7	20124	18112	170
		2565	72.1	185.0	28549	24554	154
		3420	74.4	254.6	35783	30068	141
BXRC-30E10K0-D-7x-SE	80	1050	35.4	37.2	7365	7176	198
		1400	36.2	50.6	9479	8821	187
		2100	37.6	79.0	13390	12051	170
		3150	39.5	124.4	19062	16062	153
		4200	41.2	172.9	24025	19619	139
BXRC-30G1KH0-B-7x-SE	90	900	49.6	44.7	6979	6371	156
		1200	50.5	60.6	9190	8354	152
		1800	52.0	93.6	13445	12100	144
		2700	54.1	146.1	19380	17284	133
		3600	55.8	201.0	24805	21855	123
BXRC-30G1KH0-C-7x-SE	90	855	66.2	56.6	9683	9215	171
		1140	67.3	76.7	12308	11353	160
		1710	69.4	118.7	17046	15342	144
		2565	72.1	185.0	24182	20799	131
		3420	74.4	254.6	30310	25469	119

Notes for Table 4:

1. Alternate drive currents are provided for reference only and are not a guarantee of performance.
2. Bridgelux maintains a ± 7% tolerance on flux measurements.
3. Typical stabilized DC performance values are provided as reference only and are not a guarantee of performance.

Performance at Commonly Used Drive Currents

Table 4: Product Performance at Commonly Used Drive Currents (Continued)

Part Number	CRI	Drive Current ¹ (mA)	Typical V_f $T_c = 25^\circ\text{C}$ (V)	Typical Power $T_c = 25^\circ\text{C}$ (W)	Typical Flux ² $T_c = 25^\circ\text{C}$ (lm)	Typical DC Flux ³ $T_c = 85^\circ\text{C}$ (lm)	Typical Efficacy $T_c = 25^\circ\text{C}$ (lm/W)
BXRC-30G1KH0-D-7x-SE	90	1050	35.4	37.2	6239	6079	168
		1400	36.2	50.6	8029	7472	159
		2100	37.6	79.0	11342	10208	144
		3150	39.5	124.4	16147	13605	130
		4200	41.2	172.9	20351	16618	118
BXRC-30G10K0-B-7x-SE	90	900	49.6	44.7	6689	6106	150
		1200	50.5	60.6	8807	8006	145
		1800	52.0	93.6	12885	11596	138
		2700	54.1	146.1	18573	16564	127
		3600	55.8	201.0	23771	20944	118
BXRC-30G10K0-C-7x-SE	90	855	66.2	56.6	9280	8831	164
		1140	67.3	76.7	11795	10880	154
		1710	69.4	118.7	16336	14702	138
		2565	72.1	185.0	23175	19932	125
		3420	74.4	254.6	29047	24408	114
BXRC-30G10K0-D-7x-SE	90	1050	35.4	37.2	5979	5825	161
		1400	36.2	50.6	7694	7161	152
		2100	37.6	79.0	10869	9782	138
		3150	39.5	124.4	15474	13038	124
		4200	41.2	172.9	19503	15926	113
BXRC-30H10K0-D-7x-SE	97	1050	35.4	37.2	5415	5277	146
		1400	36.2	50.6	6970	6486	138
		2100	37.6	79.0	9845	8861	125
		3150	39.5	124.4	14016	11810	113
		4200	41.2	172.9	17665	14425	102
BXRC-30A10K1-B-73-SE	93	900	49.6	44.7	6010	5486	135
		1200	50.5	60.6	7914	7193	131
		1800	52.0	93.6	11577	10420	124
		2700	54.1	146.1	16689	14883	114
		3600	55.8	201.0	21360	18819	106
BXRC-30A10K1-C-73-SE	93	855	66.2	56.6	8339	7935	147
		1140	67.3	76.7	10598	9776	138
		1710	69.4	118.7	14679	13211	124
		2565	72.1	185.0	20824	17910	113
		3420	74.4	254.6	26100	21932	103
BXRC-30A10K1-D-73-SE	93	1050	35.4	37.2	5372	5234	144
		1400	36.2	50.6	6914	6434	137
		2100	37.6	79.0	9767	8790	124
		3150	39.5	124.4	13904	11715	112
		4200	41.2	172.9	17524	14310	101
BXRC-35E10K0-B-7x-SE	80	900	49.6	44.7	8434	7698	189
		1200	50.5	60.6	11105	10094	183
		1800	52.0	93.6	16246	14621	174
		2700	54.1	146.1	23418	20884	160
		3600	55.8	201.0	29972	26408	149

Notes for Table 4:

1. Alternate drive currents are provided for reference only and are not a guarantee of performance.
2. Bridgelux maintains a $\pm 7\%$ tolerance on flux measurements.
3. Typical stabilized DC performance values are provided as reference only and are not a guarantee of performance.

Performance at Commonly Used Drive Currents

Table 4: Product Performance at Commonly Used Drive Currents (Continued)

Part Number	CRI	Drive Current ¹ (mA)	Typical V_f $T_c = 25^\circ\text{C}$ (V)	Typical Power $T_c = 25^\circ\text{C}$ (W)	Typical Flux ² $T_c = 25^\circ\text{C}$ (lm)	Typical DC Flux ³ $T_c = 85^\circ\text{C}$ (lm)	Typical Efficacy $T_c = 25^\circ\text{C}$ (lm/W)
BXRC-35E10K0-C-7x-SE	80	855	66.2	56.6	11701	11134	207
		1140	67.3	76.7	14872	13718	194
		1710	69.4	118.7	20598	18538	174
		2565	72.1	185.0	29220	25132	158
		3420	74.4	254.6	36625	30775	144
BXRC-35E10K0-D-7x-SE	80	1050	35.4	37.2	7538	7345	203
		1400	36.2	50.6	9702	9029	192
		2100	37.6	79.0	13705	12334	174
		3150	39.5	124.4	19511	16439	157
		4200	41.2	172.9	24590	20080	142
BXRC-35G10K0-B-7x-SE	90	900	49.6	44.7	6931	6327	155
		1200	50.5	60.6	9126	8296	151
		1800	52.0	93.6	13351	12016	143
		2700	54.1	146.1	19246	17164	132
		3600	55.8	201.0	24632	21703	123
BXRC-35G10K0-C-7x-SE	90	855	66.2	56.6	9616	9151	170
		1140	67.3	76.7	12222	11274	159
		1710	69.4	118.7	16928	15235	143
		2565	72.1	185.0	24014	20654	130
		3420	74.4	254.6	30100	25292	118
BXRC-35G10K0-D-7x-SE	90	1050	35.4	37.2	6195	6036	166
		1400	36.2	50.6	7973	7420	157
		2100	37.6	79.0	11263	10137	143
		3150	39.5	124.4	16035	13511	129
		4200	41.2	172.9	20209	16503	117
BXRC-35A10K1-B-73-SE	93	900	49.6	44.7	6398	5840	143
		1200	50.5	60.6	8424	7658	139
		1800	52.0	93.6	12324	11092	132
		2700	54.1	146.1	17765	15843	122
		3600	55.8	201.0	22738	20033	113
BXRC-35A10K1-C-73-SE	93	855	66.2	56.6	8877	8447	157
		1140	67.3	76.7	11282	10407	147
		1710	69.4	118.7	15626	14063	132
		2565	72.1	185.0	22167	19065	120
		3420	74.4	254.6	27784	23347	109
BXRC-35A10K1-D-73-SE	93	1050	35.4	37.2	5719	5572	154
		1400	36.2	50.6	7360	6849	145
		2100	37.6	79.0	10397	9357	132
		3150	39.5	124.4	14801	12471	119
		4200	41.2	172.9	18655	15233	108
BXRC-40C10K1-B-74-SE	70	900	49.6	44.7	8870	8096	199
		1200	50.5	60.6	11679	10616	193
		1800	52.0	93.6	17086	15377	183
		2700	54.1	146.1	24629	21965	169
		3600	55.8	201.0	31523	27774	157

Notes for Table 4:

1. Alternate drive currents are provided for reference only and are not a guarantee of performance.
2. Bridgelux maintains a $\pm 7\%$ tolerance on flux measurements.
3. Typical stabilized DC performance values are provided as reference only and are not a guarantee of performance.

Performance at Commonly Used Drive Currents

Table 4: Product Performance at Commonly Used Drive Currents (Continued)

Part Number	CRI	Drive Current ¹ (mA)	Typical V _f T _c = 25°C (V)	Typical Power T _c = 25°C (W)	Typical Flux ² T _c = 25°C (lm)	Typical DC Flux ³ T _c = 85°C (lm)	Typical Efficacy T _c = 25°C (lm/W)
BXRC-40C10K1-C-74-SE	70	855	66.2	56.6	12306	11710	217
		1140	67.3	76.7	15641	14428	204
		1710	69.4	118.7	21663	19497	183
		2565	72.1	185.0	30732	26432	166
		3420	74.4	254.6	38519	32367	151
BXRC-40C10K1-D-74-SE	70	1050	35.4	37.2	7928	7725	213
		1400	36.2	50.6	10203	9496	201
		2100	37.6	79.0	14414	12972	183
		3150	39.5	124.4	20520	17290	165
		4200	41.2	172.9	25862	21119	150
BXRC-40E10K0-B-7x-SE	80	900	49.6	44.7	8482	7743	190
		1200	50.5	60.6	11168	10152	184
		1800	52.0	93.6	16339	14705	175
		2700	54.1	146.1	23552	21004	161
		3600	55.8	201.0	30145	26560	150
BXRC-40E10K0-C-7x-SE	80	855	66.2	56.6	11768	11198	208
		1140	67.3	76.7	14957	13797	195
		1710	69.4	118.7	20716	18644	175
		2565	72.1	185.0	29388	25276	159
		3420	74.4	254.6	36835	30952	145
BXRC-40E10K0-D-7x-SE	80	1050	35.4	37.2	7582	7387	204
		1400	36.2	50.6	9757	9081	193
		2100	37.6	79.0	13783	12405	175
		3150	39.5	124.4	19623	16534	158
		4200	41.2	172.9	24732	20196	143
BXRC-40G10K0-B-7x-SE	90	900	49.6	44.7	7076	6459	158
		1200	50.5	60.6	9318	8470	154
		1800	52.0	93.6	13631	12268	146
		2700	54.1	146.1	19649	17524	135
		3600	55.8	201.0	25149	22158	125
BXRC-40G10K0-C-7x-SE	90	855	66.2	56.6	9818	9343	174
		1140	67.3	76.7	12479	11511	163
		1710	69.4	118.7	17283	15555	146
		2565	72.1	185.0	24518	21087	133
		3420	74.4	254.6	30731	25823	121
BXRC-40G10K0-D-7x-SE	90	1050	35.4	37.2	6325	6163	170
		1400	36.2	50.6	8140	7576	161
		2100	37.6	79.0	11499	10349	146
		3150	39.5	124.4	16371	13794	132
		4200	41.2	172.9	20633	16849	119
BXRC-40H10K0-D-7x-SE	97	1050	35.4	37.2	5719	5572	154
		1400	36.2	50.6	7360	6849	145
		2100	37.6	79.0	10397	9357	132
		3150	39.5	124.4	14801	12471	119
		4200	41.2	172.9	18655	15233	108

Notes for Table 4:

1. Alternate drive currents are provided for reference only and are not a guarantee of performance.
2. Bridgelux maintains a ± 7% tolerance on flux measurements.
3. Typical stabilized DC performance values are provided as reference only and are not a guarantee of performance.

Performance at Commonly Used Drive Currents

Table 4: Product Performance at Commonly Used Drive Currents (Continued)

Part Number	CRI	Drive Current ¹ (mA)	Typical V_f $T_c = 25^\circ\text{C}$ (V)	Typical Power $T_c = 25^\circ\text{C}$ (W)	Typical Flux ² $T_c = 25^\circ\text{C}$ (lm)	Typical DC Flux ³ $T_c = 85^\circ\text{C}$ (lm)	Typical Efficacy $T_c = 25^\circ\text{C}$ (lm/W)
BXRC-40A10K1-B-73-SE	93	900	49.6	44.7	6931	6327	155
		1200	50.5	60.6	9126	8296	151
		1800	52.0	93.6	13351	12016	143
		2700	54.1	146.1	19246	17164	132
		3600	55.8	201.0	24632	21703	123
BXRC-40A10K1-C-73-SE	93	855	66.2	56.6	9616	9151	170
		1140	67.3	76.7	12222	11274	159
		1710	69.4	118.7	16928	15235	143
		2565	72.1	185.0	24014	20654	130
		3420	74.4	254.6	30100	25292	118
BXRC-40A10K1-D-73-SE	93	1050	35.4	37.2	6195	6036	166
		1400	36.2	50.6	7973	7420	157
		2100	37.6	79.0	11263	10137	143
		3150	39.5	124.4	16035	13511	129
		4200	41.2	172.9	20209	16503	117
BXRC-50C10K1-B-74-SE	70	900	49.6	44.7	8918	8141	200
		1200	50.5	60.6	11743	10674	194
		1800	52.0	93.6	17179	15461	184
		2700	54.1	146.1	24764	22085	170
		3600	55.8	201.0	31695	27925	158
BXRC-50C10K1-C-74-SE	70	855	66.2	56.6	12373	11774	219
		1140	67.3	76.7	15726	14507	205
		1710	69.4	118.7	21781	19603	184
		2565	72.1	185.0	30900	26576	167
		3420	74.4	254.6	38730	32544	152
BXRC-50C10K1-D-74-SE	70	1050	35.4	37.2	7971	7767	214
		1400	36.2	50.6	10259	9548	203
		2100	37.6	79.0	14492	13043	184
		3150	39.5	124.4	20632	17384	166
		4200	41.2	172.9	26004	21234	150
BXRC-50E10K1-B-74-SE	80	900	49.6	44.7	8579	7831	192
		1200	50.5	60.6	11296	10268	187
		1800	52.0	93.6	16526	14873	177
		2700	54.1	146.1	23822	21245	163
		3600	55.8	201.0	30489	26863	152
BXRC-50E10K1-C-74-SE	80	855	66.2	56.6	11903	11326	210
		1140	67.3	76.7	15128	13955	197
		1710	69.4	118.7	20953	18858	177
		2565	72.1	185.0	29724	25565	161
		3420	74.4	254.6	37256	31306	146
BXRC-50E10K1-D-74-SE	80	1050	35.4	37.2	7668	7472	206
		1400	36.2	50.6	9869	9184	195
		2100	37.6	79.0	13941	12547	177
		3150	39.5	124.4	19847	16723	160
		4200	41.2	172.9	25014	20426	145

Notes for Table 4:

1. Alternate drive currents are provided for reference only and are not a guarantee of performance.
2. Bridgelux maintains a $\pm 7\%$ tolerance on flux measurements.
3. Typical stabilized DC performance values are provided as reference only and are not a guarantee of performance.

Performance at Commonly Used Drive Currents

Table 4: Product Performance at Commonly Used Drive Currents (Continued)

Part Number	CRI	Drive Current ¹ (mA)	Typical V_f $T_c = 25^\circ\text{C}$ (V)	Typical Power $T_c = 25^\circ\text{C}$ (W)	Typical Flux ² $T_c = 25^\circ\text{C}$ (lm)	Typical DC Flux ³ $T_c = 85^\circ\text{C}$ (lm)	Typical Efficacy $T_c = 25^\circ\text{C}$ (lm/W)
BXRC-50G10K1-B-74-SE	90	900	49.6	44.7	7416	6769	166
		1200	50.5	60.6	9764	8876	161
		1800	52.0	93.6	14285	12856	153
		2700	54.1	146.1	20592	18364	141
		3600	55.8	201.0	26355	23221	131
BXRC-50G10K1-C-74-SE	90	855	66.2	56.6	10289	9791	182
		1140	67.3	76.7	13077	12063	170
		1710	69.4	118.7	18112	16301	153
		2565	72.1	185.0	25694	22099	139
		3420	74.4	254.6	32205	27061	127
BXRC-50G10K1-D-74-SE	90	1050	35.4	37.2	6628	6459	178
		1400	36.2	50.6	8531	7939	168
		2100	37.6	79.0	12051	10846	153
		3150	39.5	124.4	17156	14455	138
		4200	41.2	172.9	21623	17657	125
BXRC-56G10K0-B-74-SE	80	900	49.6	44.7	7464	6813	167
		1200	50.5	60.6	9828	8934	162
		1800	52.0	93.6	14378	12941	154
		2700	54.1	146.1	20726	18484	142
		3600	55.8	201.0	26527	23372	132
BXRC-56G10K0-C-74-SE	80	855	66.2	56.6	10356	9855	183
		1140	67.3	76.7	13162	12141	172
		1710	69.4	118.7	18230	16407	154
		2565	72.1	185.0	25862	22243	140
		3420	74.4	254.6	32415	27238	127
BXRC-56G10K0-D-74-SE	80	1050	35.4	37.2	6672	6501	179
		1400	36.2	50.6	8586	7991	170
		2100	37.6	79.0	12129	10916	154
		3150	39.5	124.4	17268	14550	139
		4200	41.2	172.9	21764	17772	126
BXRC-56H10K0-D-74-SE	80	1050	35.4	37.2	6022	5868	162
		1400	36.2	50.6	7750	7213	153
		2100	37.6	79.0	10948	9853	139
		3150	39.5	124.4	15586	13133	125
		4200	41.2	172.9	19644	16041	114
BXRC-57C10K1-B-74-SE	70	900	49.6	44.7	8676	7920	194
		1200	50.5	60.6	11424	10384	189
		1800	52.0	93.6	16713	15041	179
		2700	54.1	146.1	24091	21485	165
		3600	55.8	201.0	30834	27167	153
BXRC-57C10K1-C-74-SE	70	855	66.2	56.6	12037	11454	213
		1140	67.3	76.7	15299	14112	199
		1710	69.4	118.7	21190	19071	179
		2565	72.1	185.0	30060	25854	162
		3420	74.4	254.6	37677	31659	148

Notes for Table 4:

1. Alternate drive currents are provided for reference only and are not a guarantee of performance.
2. Bridgelux maintains a $\pm 7\%$ tolerance on flux measurements.
3. Typical stabilized DC performance values are provided as reference only and are not a guarantee of performance.

Performance at Commonly Used Drive Currents

Table 4: Product Performance at Commonly Used Drive Currents (Continued)

Part Number	CRI	Drive Current ¹ (mA)	Typical V _f T _c = 25°C (V)	Typical Power T _c = 25°C (W)	Typical Flux ² T _c = 25°C (lm)	Typical DC Flux ³ T _c = 85°C (lm)	Typical Efficacy T _c = 25°C (lm/W)
BXRC-57C10K1-D-74-SE	70	1050	35.4	37.2	7755	7556	208
		1400	36.2	50.6	9980	9288	197
		2100	37.6	79.0	14099	12689	179
		3150	39.5	124.4	20071	16912	161
		4200	41.2	172.9	25297	20657	146
BXRC-57E10K1-B-74-SE	80	900	49.6	44.7	8240	7521	184
		1200	50.5	60.6	10849	9862	179
		1800	52.0	93.6	15872	14285	170
		2700	54.1	146.1	22879	20404	157
		3600	55.8	201.0	29283	25801	146
BXRC-57E10K1-C-74-SE	80	855	66.2	56.6	11432	10878	202
		1140	67.3	76.7	14530	13403	189
		1710	69.4	118.7	20124	18112	170
		2565	72.1	185.0	28549	24554	154
		3420	74.4	254.6	35783	30068	141
BXRC-57E10K1-D-74-SE	80	1050	35.4	37.2	7365	7176	198
		1400	36.2	50.6	9479	8821	187
		2100	37.6	79.0	13390	12051	170
		3150	39.5	124.4	19062	16062	153
		4200	41.2	172.9	24025	19619	139
BXRC-65C10K1-B-74-SE	70	900	49.6	44.7	8676	7920	194
		1200	50.5	60.6	11424	10384	189
		1800	52.0	93.6	16713	15041	179
		2700	54.1	146.1	24091	21485	165
		3600	55.8	201.0	30834	27167	153
BXRC-65C10K1-C-74-SE	70	855	66.2	56.6	12037	11454	213
		1140	67.3	76.7	15299	14112	199
		1710	69.4	118.7	21190	19071	179
		2565	72.1	185.0	30060	25854	162
		3420	74.4	254.6	37677	31659	148
BXRC-65C10K1-D-74-SE	70	1050	35.4	37.2	7755	7556	208
		1400	36.2	50.6	9980	9288	197
		2100	37.6	79.0	14099	12689	179
		3150	39.5	124.4	20071	16912	161
		4200	41.2	172.9	25297	20657	146
BXRC-65E10K1-B-74-SE	80	900	49.6	44.7	8337	7610	187
		1200	50.5	60.6	10977	9978	181
		1800	52.0	93.6	16059	14453	172
		2700	54.1	146.1	23149	20644	158
		3600	55.8	201.0	29628	26104	147
BXRC-65E10K1-C-7x-SE	80	855	66.2	56.6	11566	11006	204
		1140	67.3	76.7	14701	13561	192
		1710	69.4	118.7	20361	18325	172
		2565	72.1	185.0	28884	24843	156
		3420	74.4	254.6	36204	30421	142

Notes for Table 4:

1. Alternate drive currents are provided for reference only and are not a guarantee of performance.
2. Bridgelux maintains a ± 7% tolerance on flux measurements.
3. Typical stabilized DC performance values are provided as reference only and are not a guarantee of performance.

Performance at Commonly Used Drive Currents

Table 4: Product Performance at Commonly Used Drive Currents (Continued)

Part Number	CRI	Drive Current ¹ (mA)	Typical V_f $T_c = 25^\circ\text{C}$ (V)	Typical Power $T_c = 25^\circ\text{C}$ (W)	Typical Flux ² $T_c = 25^\circ\text{C}$ (lm)	Typical DC Flux ³ $T_c = 85^\circ\text{C}$ (lm)	Typical Efficacy $T_c = 25^\circ\text{C}$ (lm/W)
BXRC-65E10K1-D-7X-SE	80	1050	35.4	37.2	7452	7261	200
		1400	36.2	50.6	9590	8925	189
		2100	37.6	79.0	13547	12192	172
		3150	39.5	124.4	19286	16251	155
		4200	41.2	172.9	24308	19849	141

Notes for Table 4:

1. Alternate drive currents are provided for reference only and are not a guarantee of performance.
2. Bridgelux maintains a $\pm 7\%$ tolerance on flux measurements.
3. Typical stabilized DC performance values are provided as reference only and are not a guarantee of performance.

Electrical Characteristics

Table 5: Electrical Characteristics

Part Number	Drive Current (mA)	Forward Voltage Pulsed, $T_c = 25^\circ\text{C}$ (V) ^{1, 2, 3, 8}			Typical Coefficient of Forward Voltage ⁴ $\Delta V_f / \Delta T_c$ (mV/ $^\circ\text{C}$)	Typical Thermal Resistance Junction to Case ^{5,6} R_{j-c} ($^\circ\text{C}/\text{W}$)	Driver Selection Voltages ⁷ (V)	
		Minimum	Typical	Maximum			V_f Min. Hot $T_c = 105^\circ\text{C}$ (V)	V_f Max. Cold $T_c = -40^\circ\text{C}$ (V)
BXRC-xxx10Kx-B-7x-SE	1800	48.1	52.0	55.9	-24.9	0.06	46.1	57.5
	3600	51.7	55.8	60.0	-24.9	0.07	49.7	61.6
BXRC-xxx10Kx-C-7x-SE	1710	64.2	69.4	74.6	-33.2	0.04	61.5	76.8
	3420	68.8	74.4	80.0	-33.2	0.05	66.2	82.2
BXRC-xxx10Kx-D-7x-SE	2100	34.8	37.6	40.4	-17.4	0.06	33.4	41.6
	4200	38.1	41.2	44.3	-17.4	0.07	36.7	45.4

Notes for Table 5:

- Parts are tested in pulsed conditions. $T_c = 25^\circ\text{C}$. Pulse width is 10ms.
- Voltage minimum and maximum are provided for reference only and are not a guarantee of performance.
- Bridgelux maintains a tester tolerance of $\pm 0.10\text{V}$ on forward voltage measurements.
- Typical coefficient of forward voltage tolerance is $\pm 0.1\text{mV}$ for nominal current.
- Thermal resistance values are based from test data of a 3000K 80 CRI product.
- Thermal resistance value was calculated using total electrical input power; optical power was not subtracted from input power. The thermal interface material used during testing is not included in the thermal resistance value.
- V_f min hot and max cold values are provided as reference only and are not guaranteed by test. These values are provided to aid in driver design and selection over the operating range of the product.
- This product has been designed and manufactured per IEC 62031:2014. This product has passed dielectric withstand voltage testing at 1160 V. The working voltage designated for the insulation is 80V d.c. The maximum allowable voltage across the array must be determined in the end product application.

Eye Safety

Table 6: Eye Safety Risk Group (RG) Classifications

Part Number	Drive Current ⁵ (mA)	CCT ⁵			
		2700K/3000K	4000K ²	5000K ³	6500K ⁴
BXRC-xxx10Kx-B-7x-SE	1800	RG1	RG1	RG1	RG1
	2700	RG1	RG1	RG2	RG2
	3600	RG1	RG1	RG2	RG2
BXRC-xxx10Kx-C-7x-SE	1710	RG1	RG1	RG1	RG2
	2565	RG1	RG1	RG2	RG2
	3420	RG1	RG2	RG2	RG2
BXRC-xxx10Kx-D-7x-SE	2100	RG1	RG1	RG1	RG1
	3150	RG1	RG1	RG1	RG2
	4200	RG1	RG1	RG2	RG2

Notes for Table 6:

1. Eye safety classification for the use of Bridgelux Vero SE Series LED arrays is in accordance with specification IEC/TR 62778: Application of IEC 62471 for the assessment of blue light hazard to light sources and luminaires.
2. For products classified as RG2 at 4000K, $E_{thr} = 1847.5$ lx.
3. For products classified as RG2 at 5000K $E_{thr} = 1315.8$ lx.
4. For products classified as RG2 at 6500K, $E_{thr} = 1124.5$ lx.
5. Please contact your Bridgelux sales representative for E_{thr} values at specific drive currents and CCTs not listed.

Absolute Maximum Ratings

Table 7: Maximum Ratings

Parameter	Maximum Rating		
LED Junction Temperature (T _j)	150°C		
Storage Temperature	-40°C to +105°C		
Operating Case Temperature ¹ (T _c)	105°C		
	BXRC-xxx10Kx-B-7x-SE	BXRC-xxx10Kx-C-7x-SE	BXRC-xxx10Kx-D-7x-SE
Maximum Drive Current ³	3600mA	3420mA	4200mA
Maximum Peak Pulsed Drive Current ⁴	5140mA	4890mA	6000mA
Maximum Reverse Voltage ⁵	-90V	-120V	-65V

Notes for Table 7:

1. For IEC 62717 requirement, please consult your Bridgelux sales representative.
2. Refer to Bridgelux Application Note AN120: Assembly Considerations for Bridgelux Vero SE LED Arrays.
3. Arrays may be driven at higher currents however lumen maintenance may be reduced.
4. Bridgelux recommends a maximum duty cycle of 10% and pulse width of 20 ms when operating LED Arrays at maximum peak pulsed current specified. Maximum peak pulsed currents indicate values where LED Arrays can be driven without catastrophic failures.
5. Light emitting diodes are not designed to be driven in reverse voltage and will not produce light under this condition. Maximum rating provided for reference only.

Performance Curves

Figure 1: Vero SE 29B Drive Current vs. Voltage

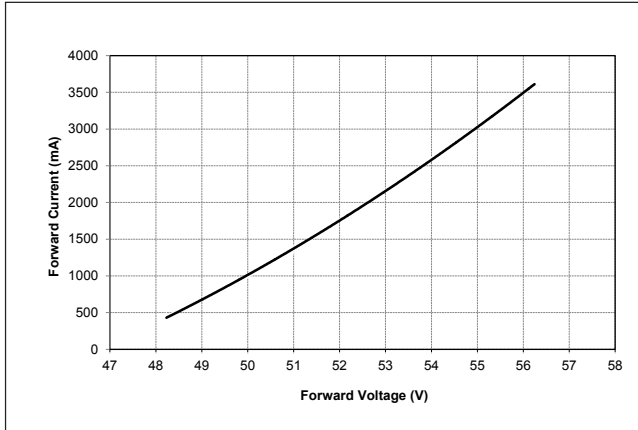

Figure 2: Vero SE 29C Drive Current vs. Voltage

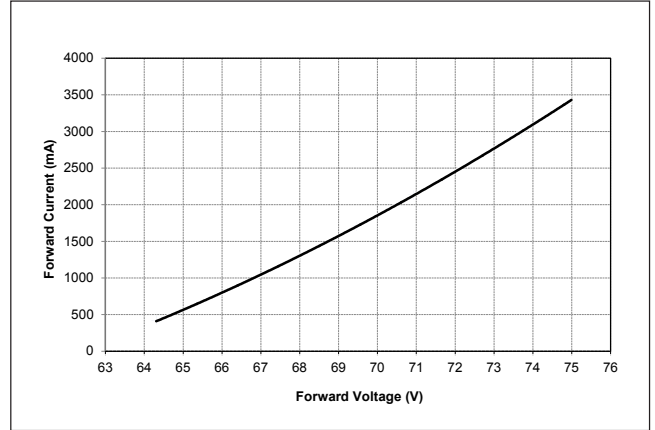

Figure 3: Vero SE 29D Drive Current vs. Voltage

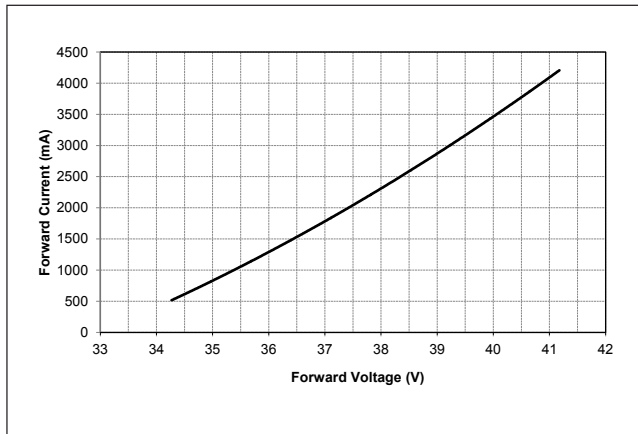

Figure 4: Vero SE 29B Typical Relative Flux vs. Current

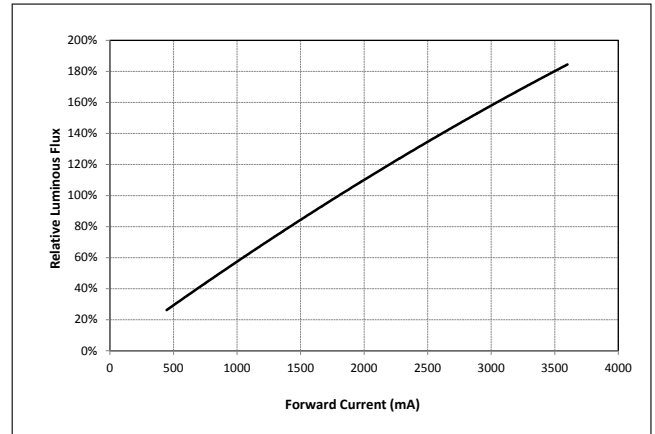

Figure 5: Vero SE 29C Typical Relative Flux vs. Current

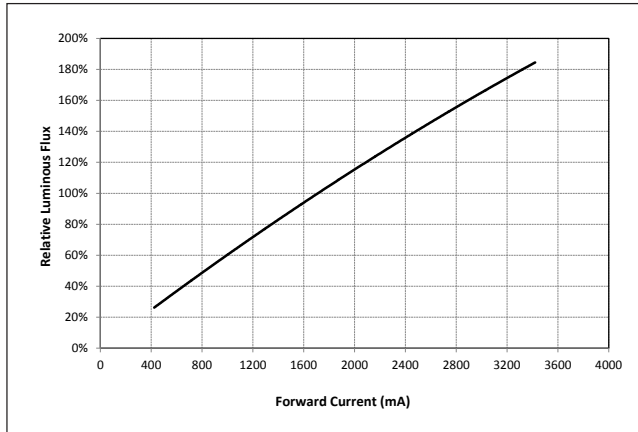
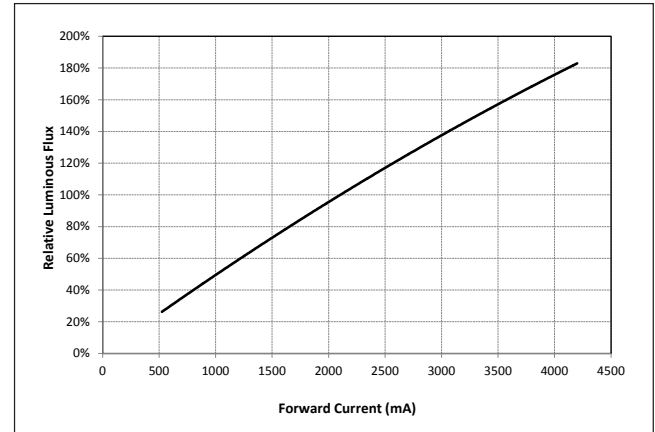

Figure 6: Vero SE 29D Typical Relative Flux vs. Current



Notes for Figures 1-6:

1. Bridgelux does not recommend driving high power LEDs at low currents. Doing so may produce unpredictable results. Pulse width modulation (PWM) is recommended for dimming effects.
2. Products tested under pulsed condition (10ms pulse width) at nominal test current where T_J (junction temperature) = T_C (case temperature) = 25°C.

Performance Curves

Figure 7: Typical DC Flux vs. Case Temperature

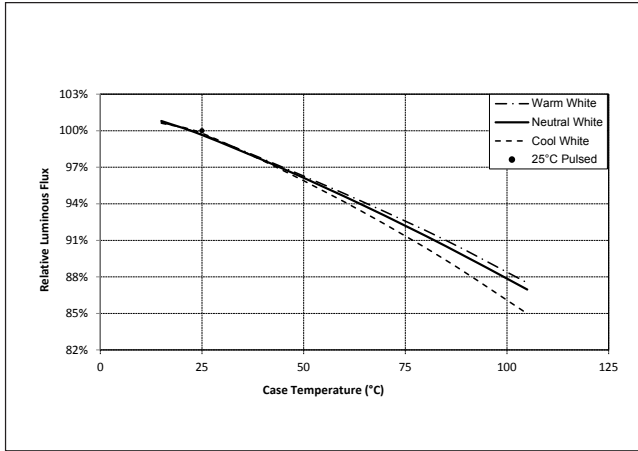

Figure 8: Typical DC ccy Shift vs. Case Temperature

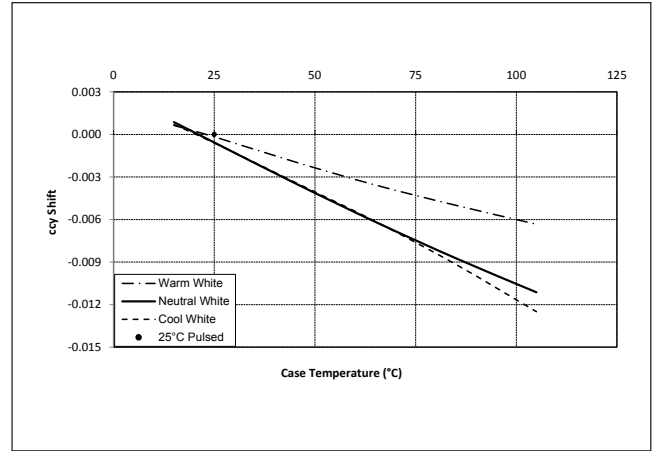

Figure 9: Typical DC ccx Shift vs. Case Temperature

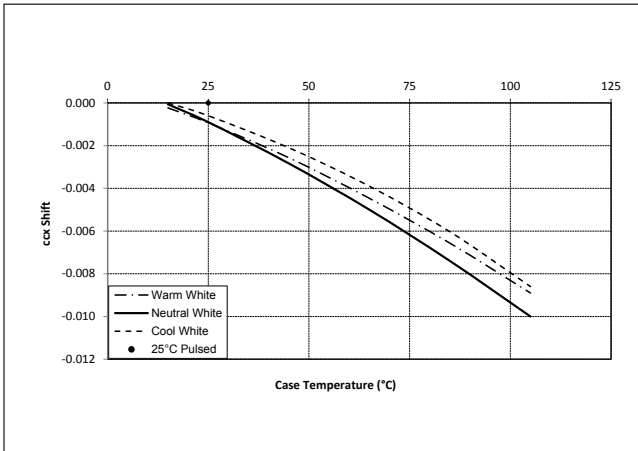
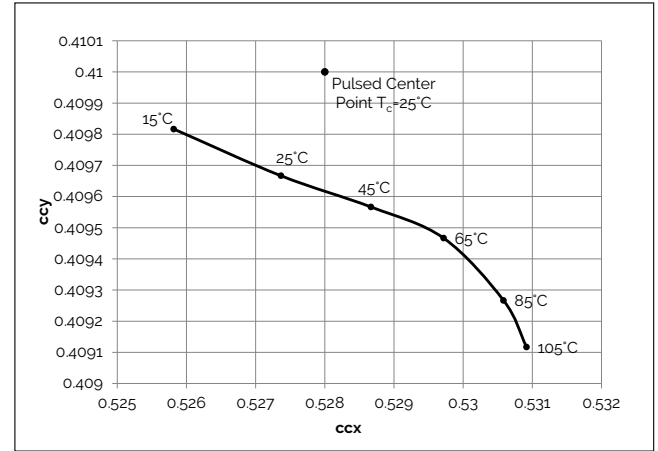

Figure 10: 2000K, 65 CRI Color Shift vs. Case Temperature



Notes for Figures 7-9:

1. Characteristics shown for warm white based on 3000K and 80 CRI.
2. Characteristics shown for neutral white based on 4000K and 80 CRI.
3. Characteristics shown for cool white based on 5000K and 70 CRI.
4. For other color SKUs, the shift in color will vary. Please contact your Bridgelux Sales Representative for more information.

Performance Curves

Figure 11: 1750K Color Shift vs. Case Temperature¹

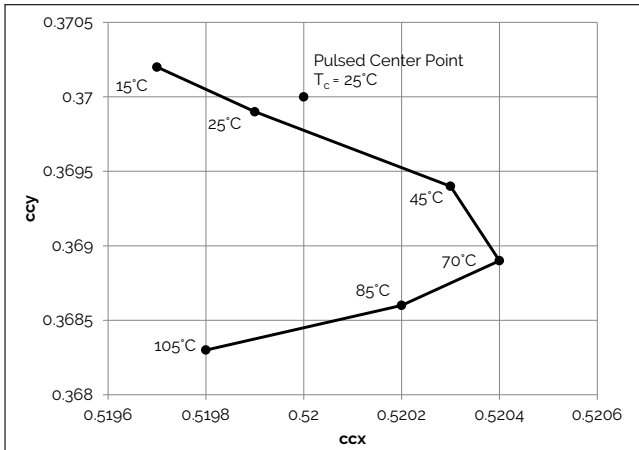

Figure 12: 2500K Color Shift vs. Case Temperature¹

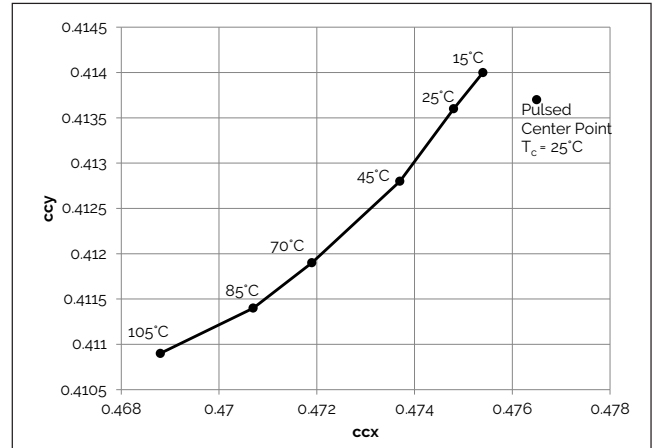

Figure 13: 5600K Color Shift vs. Case Temperature^{1,3}

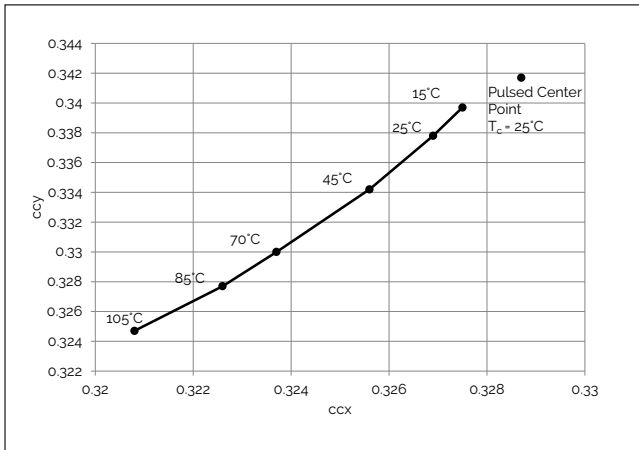

Figure 14: 3000K Class A Color Shift vs. Case Temperature¹

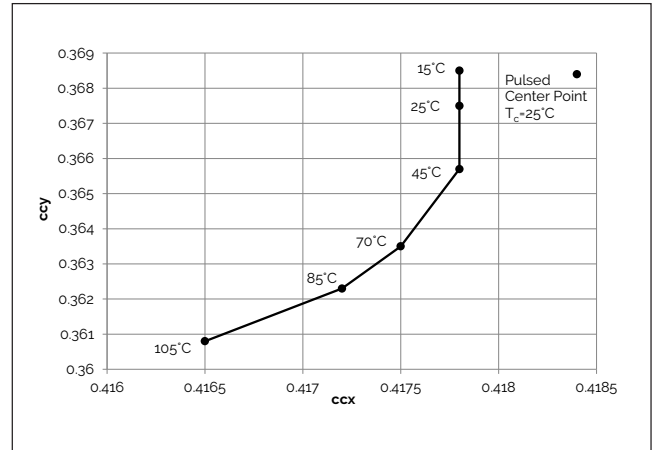

Figure 15: 3500K Class A Color Shift vs. Case Temperature¹

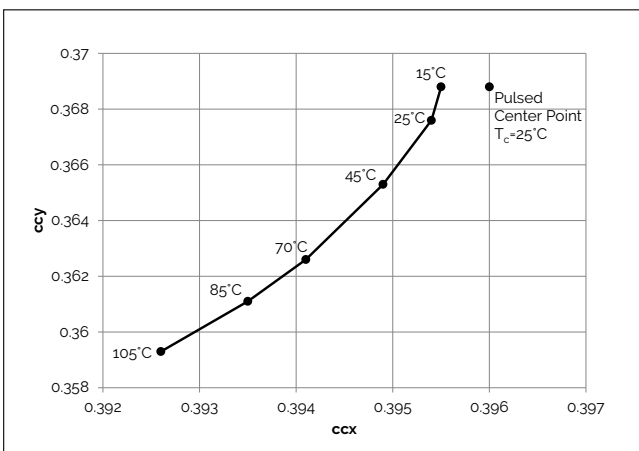
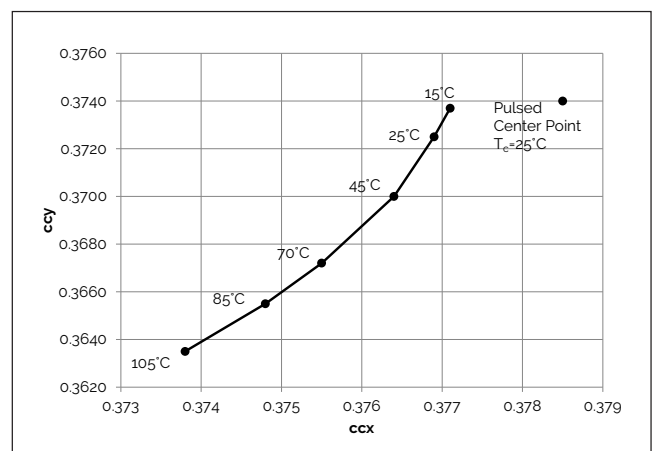

Figure 16: 4000K Class A Color Shift vs. Case Temperature¹



Note for Figures 10-16:

1. Measurements made under DC test conditions at the nominal drive current.
2. Typical color shift is shown with a tolerance of ± 0.002 .
3. Color shift shown for product hot targeted at $T_c = 85^\circ\text{C}$

Performance Curves

Figure 17: Vero SE 29D Drive Current Derating Curve

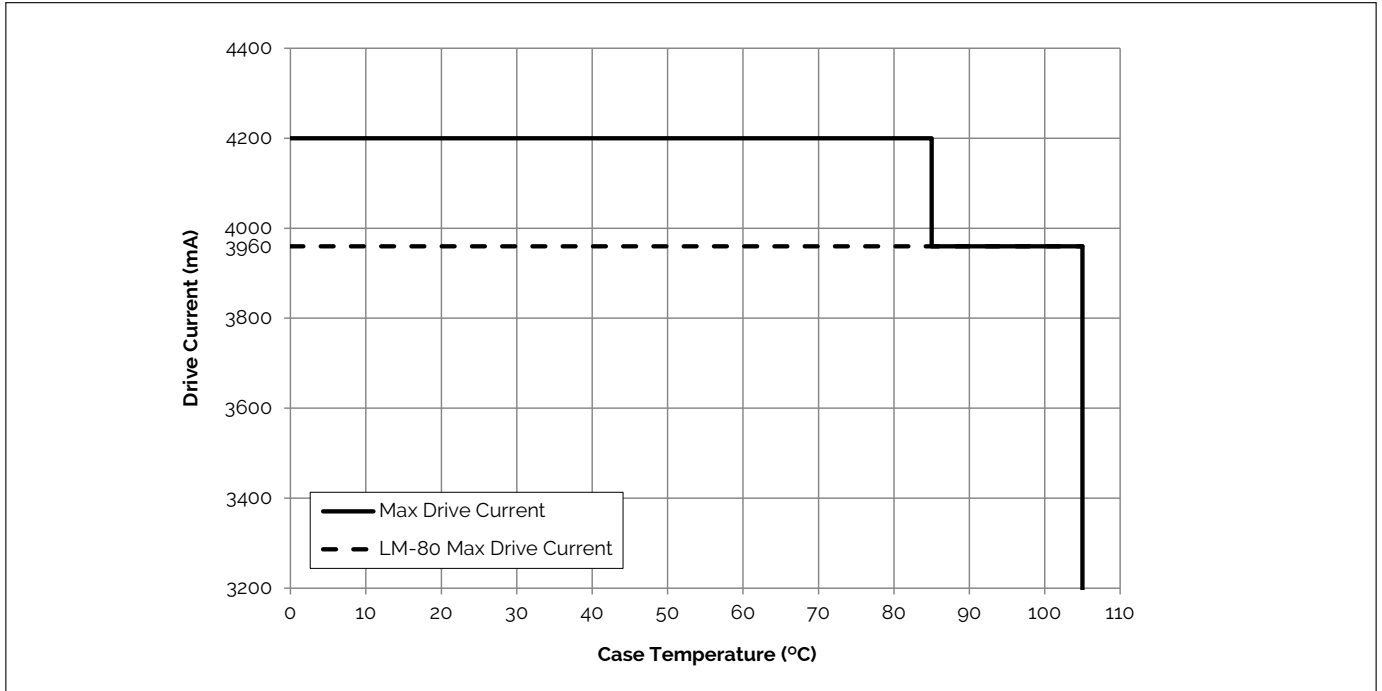

Notes for Figure 17:

1. The maximum allowable drive current for the Vero 29D product is dependent on the operating case temperature. Please refer to the Product Feature Map (page 2) for the location of the T_c Point
2. LM-80 Max Drive Current must not be exceeded in order to meet LM-80 lifetime projections.
3. Lumen maintenance (L70) and lifetime predictions are valid for drive current and case temperature conditions used for LM-80 testing as included in the applicable LM-80 test report for these products. Contact your Bridgelux sales representative for LM-80 report.

Typical Radiation Pattern

Figure 18: Typical Spatial Radiation Pattern

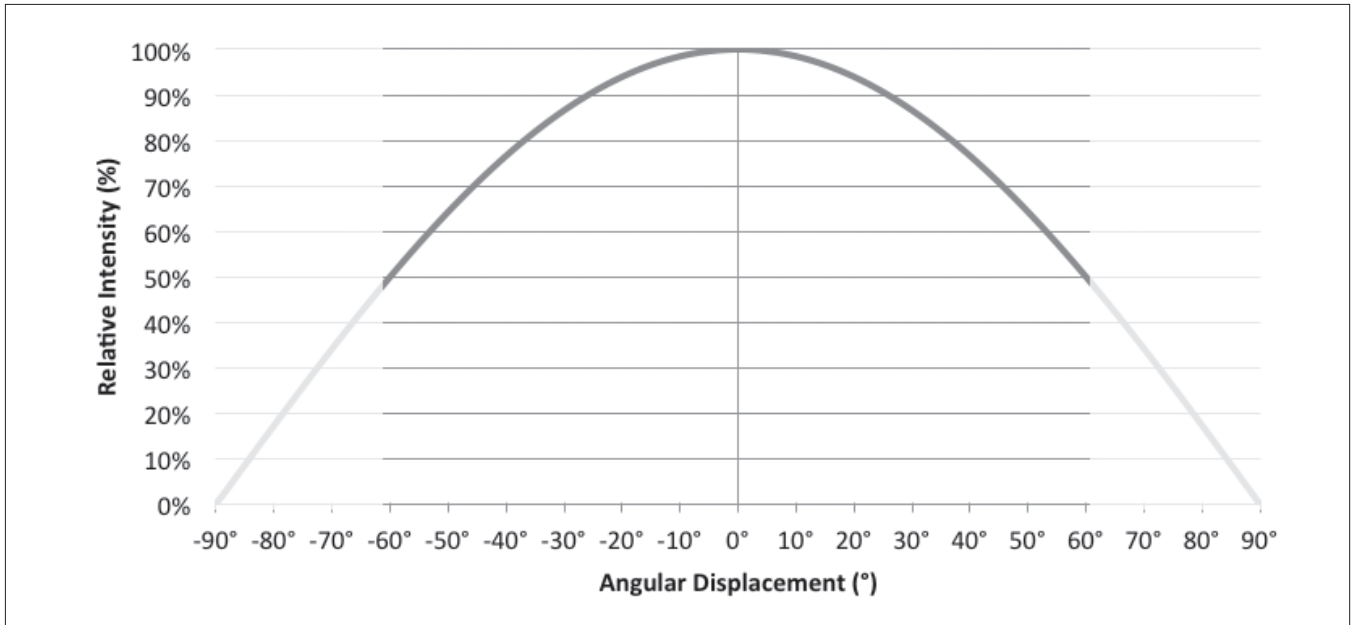

Note for Figure 18:

1. Typical viewing angle is 120°.
2. The viewing angle is defined as the off axis angle from the centerline where intensity is ½ of the peak value.

Figure 19: Typical Polar Radiation Pattern

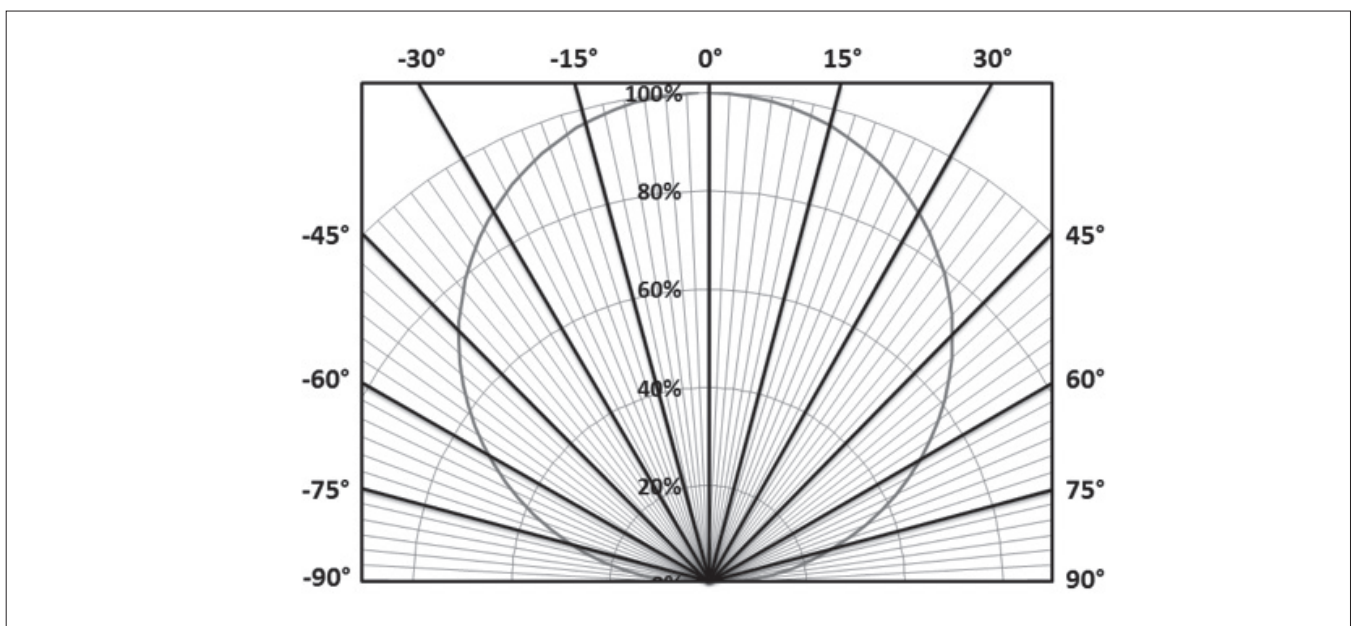

Typical Color Spectrum

Figure 20: Typical Color Spectrum

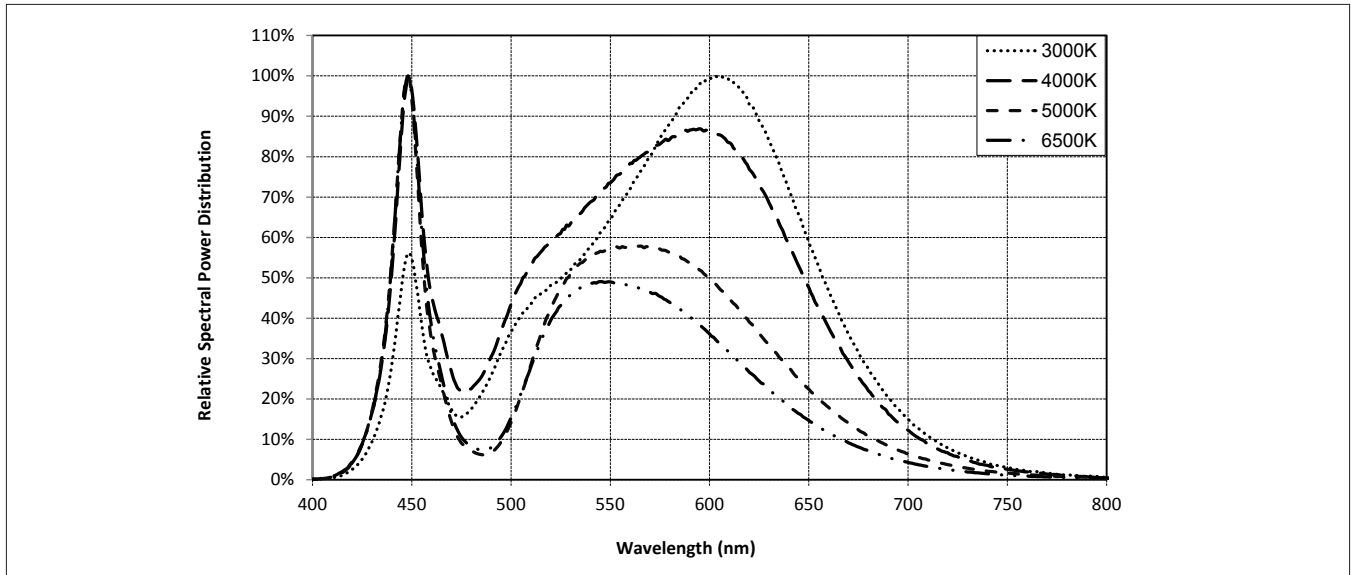

Note for Figure 20:

1. Color spectra measured at nominal current for $T_j = T_c = 25^\circ\text{C}$.
2. Color spectra shown is 3000K and 80 CRI.
3. Color spectra shown is 4000K and 80 CRI.
4. Color spectra shown is 5000K and 70 CRI.
4. Color spectra shown is 6500K and 70 CRI.

Figure 21: Typical Color Spectrum for Vero SE 29 with Décor Series

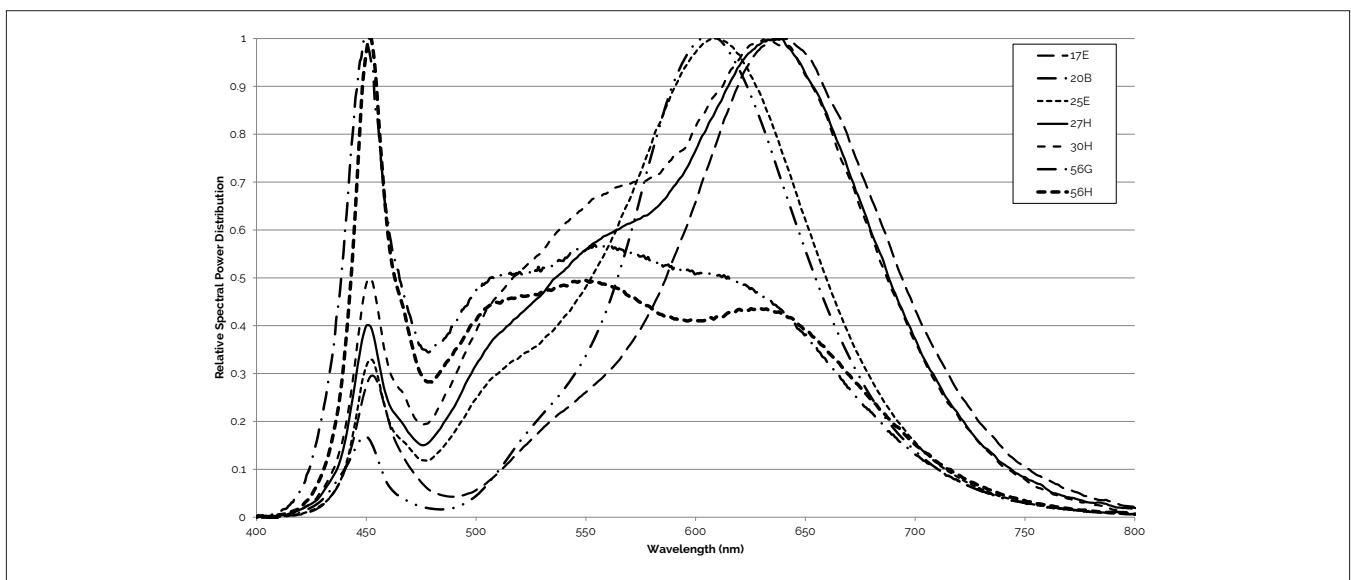

Note for Figure 21:

1. Color spectra measured at nominal current for $T_j = T_c = 25^\circ\text{C}$.

Mechanical Dimensions

Figure 22: Drawing for Vero SE 29 LED Array

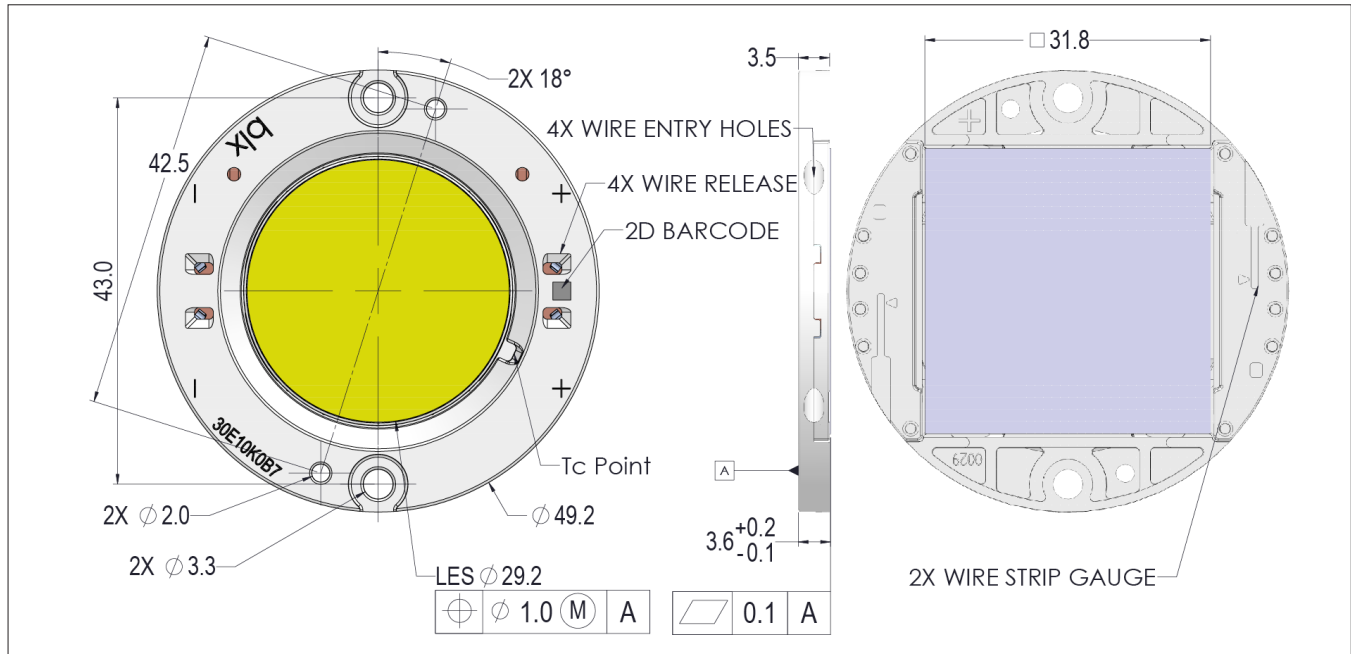

Notes for Figure 22:

1. Drawings are not to scale.
2. Drawing dimensions are in millimeters.
3. Unless otherwise specified, tolerances are $\pm 0.10\text{mm}$.
4. Mounting holes (2X) are for M3 screws.
5. Bridgelux recommends two tapped holes for mounting screws with $43.0 \pm 0.10\text{mm}$ center-to-center spacing.
6. Screws with flat shoulders (pan, dome, button, round, truss, mushroom) provide optimal torque control. Do NOT use flat, countersink, or raised head screws.
7. The optical center of the LED Array is nominally defined by the mechanical center of the array to a tolerance of $\pm 0.2\text{mm}$.
8. Bridgelux maintains a flatness of 0.10mm across the mounting surface of the array.

Color Binning Information

Figure 23: Graph of Warm and Neutral White Test Bins in xy Color Space

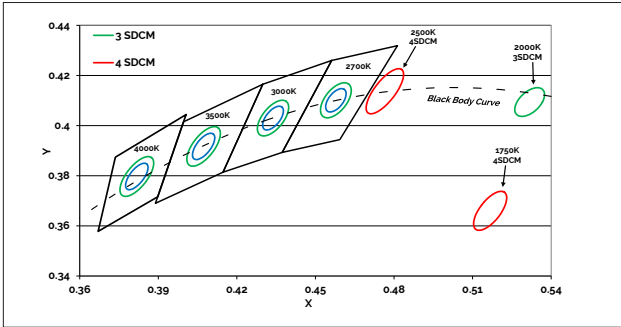

Note: Pulsed Test Conditions, $T_c = 25^\circ\text{C}$

Table 8: Warm and Neutral White xy Bin Coordinates and Associated Typical CCT

Bin Code	1750K	2500K	2700K	3000K ¹	3500K ¹	4000K ¹
ANSI Bin (for reference only)	-	-	(2580K - 2870K)	(2870K - 3220K)	(3220K - 3710K)	(3710K - 4260K)
73 (3 SDCM)	-	-	(2651K - 2794K)	(2968K - 3136K)	(3369K - 3586K)	(3851K - 4130K)
72 (2 SDCM)	-	-	(2674K - 2769K)	(2995K - 3107K)	(3404K - 3548K)	(3895K - 4081K)
Center Point (x,y)	(0.5167, 0.336)	(0.4765, 0.4137)	(0.4578, 0.4101)	(0.4338, 0.403)	(0.4073, 0.3917)	(0.3818, 0.3797)

Note for Table 8:

1. Color Binning information excludes Class A products. Please contact your Bridgelux Sales Representative for more information.

Figure 24: Graph of Cool White Test Bins in xy Color Space

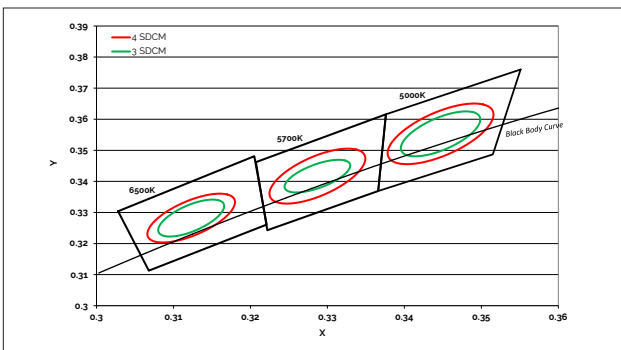

Note: Pulsed Test Conditions, $T_c = 25^\circ\text{C}$

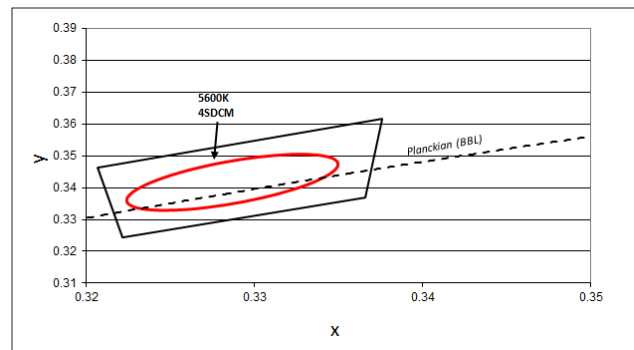

Note: Pulsed Test Conditions, $T_c = 25^\circ\text{C}$

Table 9: Cool White xy Bin Coordinates and Associated Typical CCT (product is hot targeted to $T_c = 85^\circ\text{C}$)

Bin Code	5000K	5600K ¹	5700K	6500K
ANSI Bin (for reference only)	(4745K - 5311K)	(5310K - 6020K)	(5312K - 6022K)	(6022K - 7042K)
74 (4 SDCM)	(4801K - 5282K)	(5475K - 5830K)	(5829K - 5481K)	(6270K - 6765K)
73 (3 SDCM)	(4835K - 5215K)	(5490K - 5820K)	(5490K - 5820K)	(6250K - 6745K)
Center Point (x,y)	(0.3447, 0.3553)	(0.3293, 0.3423)	(0.3287, 0.3417)	(0.3123, 0.3282)

Note for Table 9:

1. Select configurations with a CCT of 5600K are available with center point targets at $T_c = 85^\circ\text{C}$ or $T_c = 25^\circ\text{C}$.

Packaging and Labeling

Figure 25: Drawing for Vero SE 29 Packaging Tray

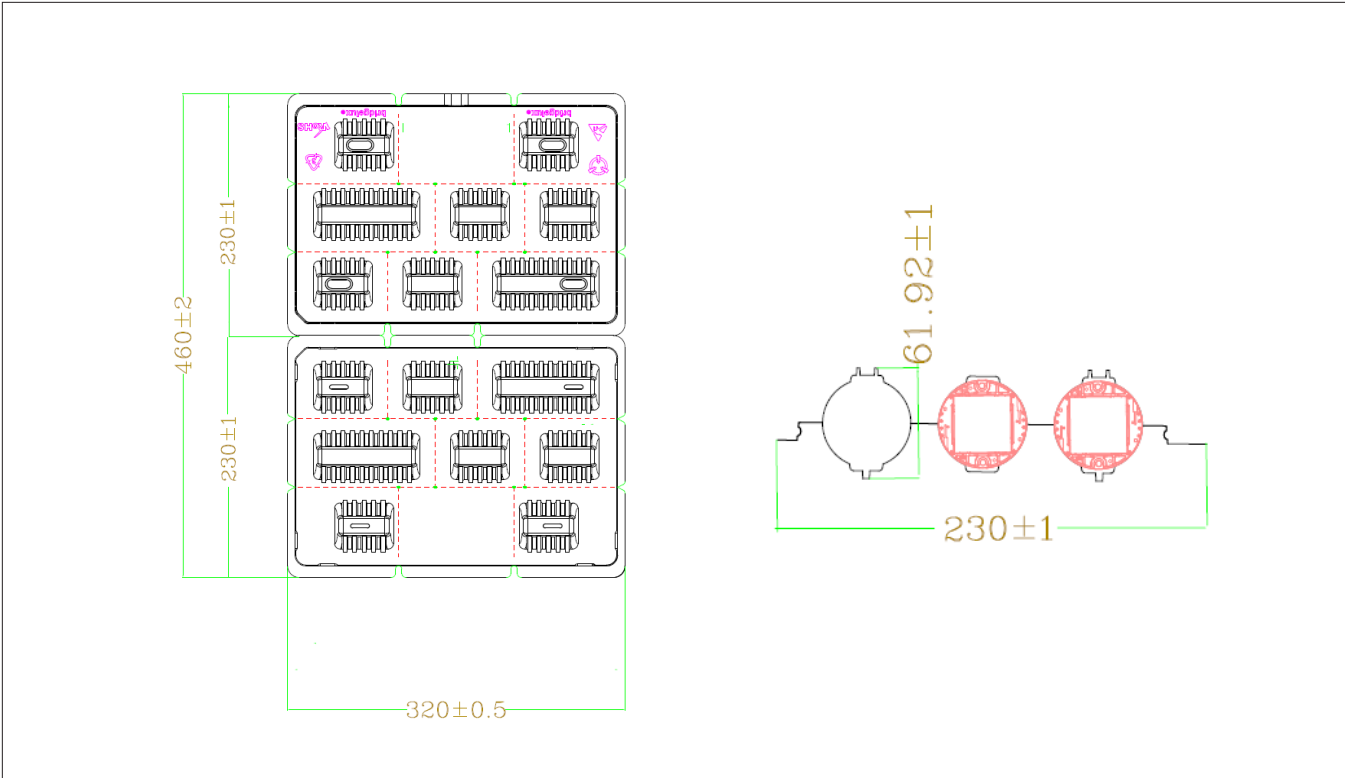

- Notes for Figure 25:
- 1. Dimensions are in millimeters.
 - 2. Drawings are not to scale.

Packaging and Labeling

Figure 26: Vero SE Series Packaging and Labeling

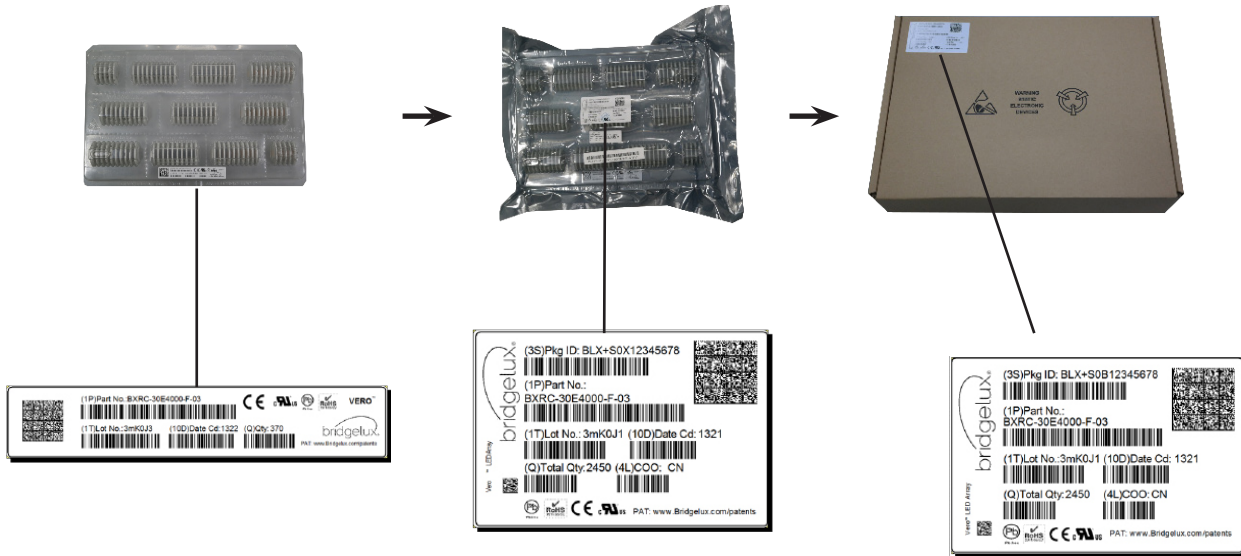

Notes for Figure 26:

1. Each tray holds 50 COBs.
2. Each tray is vacuum sealed in an anti-static bag and placed in its own box.
3. Each tray, bag and box is to be labeled as shown above.

Figure 27: Vero SE Product Labeling

Bridgelux COB arrays have laser markings on the back side of the substrate to help with product identification. In addition to the product identification markings, Bridgelux COB arrays also contain markings for internal Bridgelux manufacturing use only. The image below shows which markings are for customer use and which ones are for Bridgelux internal use only. The Bridgelux internal manufacturing markings are subject to change without notice, however these will not impact the form, function or performance of the COB array.



Customer Use- 2D Barcode
Scannable barcode provides product part number and other Bridgelux internal production information.

Customer Use- Product part number

30E10K0C 73 2F

Customer Use- V, Bin Code included to enable greater luminaire design flexibility. Refer to ANg2 for bin definitions.

Design Resources

Application Notes

Bridgelux has developed a comprehensive set of application notes and design resources to assist customers in successfully designing with the Vero product family of LED array products. For all available application notes visit www.bridgelux.com.

Optical Source Models

Optical source models and ray set files are available for all Bridgelux products. For a list of available formats, visit www.bridgelux.com.

3D CAD Models

Three dimensional CAD models depicting the product outline of all Bridgelux Vero LED arrays are available in both IGS and STEP formats. Please contact your Bridgelux sales representative for assistance.

LM80

LM80 testing has been completed and the LM80 report is now available. Please contact your Bridgelux sales representative for LM-80 report.

Precautions

CAUTION: CHEMICAL EXPOSURE HAZARD

Exposure to some chemicals commonly used in luminaire manufacturing and assembly can cause damage to the LED array. Please consult Bridgelux Application Note AN120 for additional information.

CAUTION: RISK OF BURN

Do not touch the Vero LED array during operation. Allow the array to cool for a sufficient period of time before handling. The Vero LED array may reach elevated temperatures such that could burn skin when touched.

CAUTION

CONTACT WITH LIGHT EMITTING SURFACE (LES)

Avoid any contact with the LES. Do not touch the LES of the LED array or apply stress to the LES (yellow phosphor resin area). Contact may cause damage to the LED array.

Optics and reflectors must not be mounted in contact with the LES (yellow phosphor resin area). Optical devices may be mounted on the top surface of the plastic housing of the Vero LED array. Use the mechanical features of the LED array housing, edges and/or mounting holes to locate and secure optical devices as needed.

Disclaimers

MINOR PRODUCT CHANGE POLICY

The rigorous qualification testing on products offered by Bridgelux provides performance assurance. Slight cosmetic changes that do not affect form, fit, or function may occur as Bridgelux continues product optimization.

STANDARD TEST CONDITIONS

Unless otherwise stated, array testing is performed at the nominal drive current.

About Bridgelux: Bridging Light and Life™

At Bridgelux, we help companies, industries and people experience the power and possibility of light. Since 2002, we've designed LED solutions that are high performing, energy efficient, cost effective and easy to integrate. Our focus is on light's impact on human behavior, delivering products that create better environments, experiences and returns—both experiential and financial. And our patented technology drives new platforms for commercial and industrial luminaires.

For more information about the company, please visit
bridgelux.com
twitter.com/Bridgelux
facebook.com/Bridgelux
youtube.com/user/Bridgelux
linkedin.com/company/bridgelux-inc-_2
WeChat ID: BridgeluxInChina



46430 Fremont Boulevard
Fremont, CA 94538 U.S.A.
Tel (925) 583-8400
www.bridgelux.com

© 2016-2019 Bridgelux, Inc. All rights reserved. Product specifications are subject to change without notice. Bridgelux, the Bridgelux stylized logo design, Vero, V Series and V Series HD are registered trademarks, and Decor Series is a trademark of Bridgelux, Inc. All other trademarks are the property of their respective owners.

Bridgelux Vero SE 29 Array Series Product Data Sheet DS123 Rev. L (03/2019)