

6V to 42V, 0.5A 1ch Simple Buck Converter Integrated FET

BD9G102G-LB

General Description

This product guarantees long time support in Industrial market.

The BD9G102G-LB is a 42V, 0.5A non-synchronous buck converter with integrated internal high-side 42V Power MOSFET. Operating frequency is 1.0MHz fixed by inner circuit. The components of phase compensation are built in. Additional protection features are included such as Over Current Protection, Thermal Shutdown and Under Voltage Lockout.

Features

- Long Time Support Product for Industrial Applications.
- Wide Operating Input Range 6V to 42V
- 45V/800mΩ Internal Power MOSFET
- 1.0MHz Fixed Operating Frequency
- Feedback Pin Voltage $0.75V \pm 2.0\%$
- Accurate EN Threshold $1.8V \pm 0.1V$
- Current Mode
- Internal Compensation
- Cycle-by-Cycle Over Current Protection(OCP)
- Under Voltage Locked Out(UVLO), Over Voltage Protection(OVP), Thermal Shut Down(TSD)
- 0μA Low Shutdown Supply Current

Key Specifications

- | | |
|-----------------------------|----------------|
| ■ Input Voltage Range: | 6V to 42 V |
| ■ Ref. Precision (Ta=25°C): | ±2.0 % |
| ■ Max Output Current: | 0.5A (Max) |
| ■ Switching Frequency: | 1.0MHz (Typ) |
| ■ Shutdown Current: | 0μA (Typ) |
| ■ Operating Temperature: | -40°C to +85°C |

Package

SSOP6

W(Typ) x D(Typ) x H(Max)

2.90mm x 2.80mm x 1.25mm



SSOP6

Applications

- Industrial Equipment
- Battery Powered Equipment
- OA Instrument

Typical Application Circuit

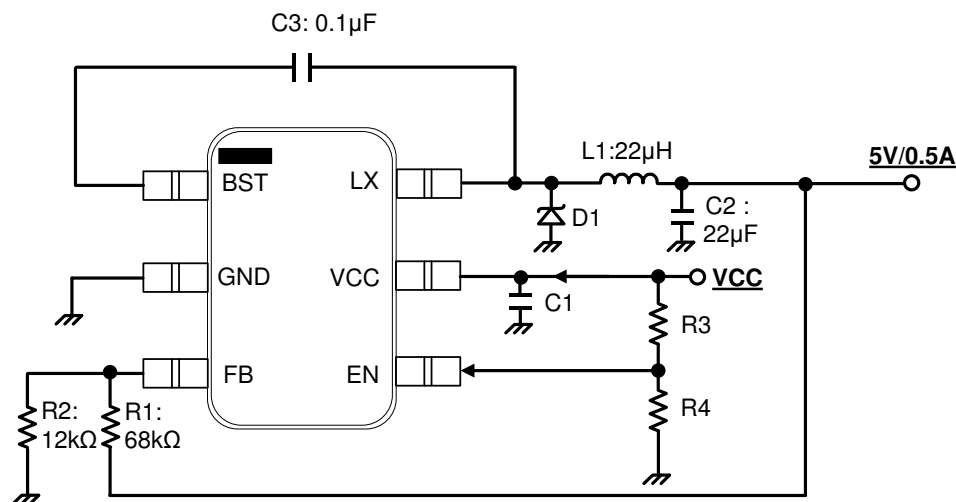

Figure 1. Typical Application Circuit

Pin Configuration

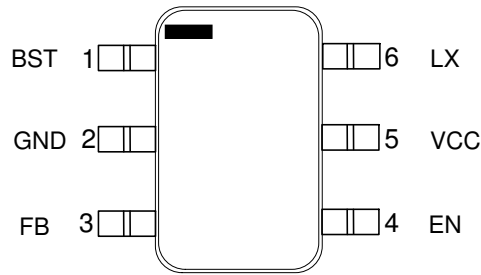

Figure 2. Pin Configuration (TOP VIEW)

Pin Description

Pin No.	Pin Name	Description
1	BST	The pin is power supply for floating Power NMOS driver. Connect bypass capacitor between the pin and LX pin for bootstrap operation. A 0.1µF ceramic capacitor is recommended.
2	GND	Ground.
3	FB	Voltage feedback pin. This pin is error-amp negative input. This pin voltage is set to 0.75V in application.
4	EN	The BD9G102G-LB is shut down when this pin is smaller than 0.5 V and non-switching mode when this pin is between 0.5 V and 1.8 V, active when this pin is 1.8V or more.
5	VCC	Input supply. Place bypass capacitor as close as possible to this pin.
6	LX	Power FET switch output. Place schottky barrier diode and inductor as close as possible to this pin.

Block Diagram

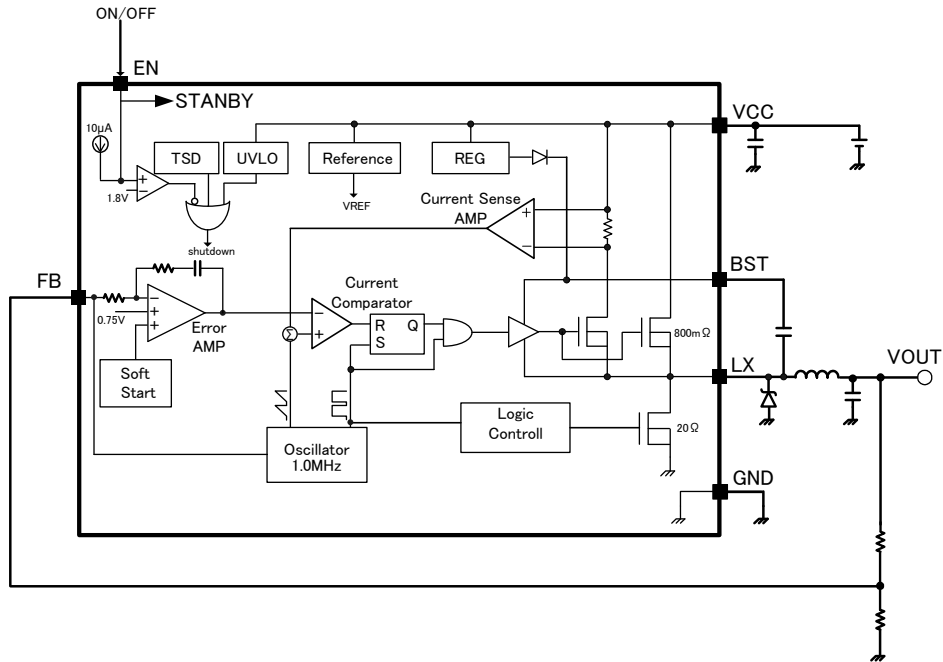

Figure 3. Block Diagram

Description of Blocks

1. Reference
This block generates reference voltage and current. It starts operation by applying EN=H. It provides reference voltage and current to error-amp, oscillator, and etc.
2. REG
This is a gate drive voltage generator and 5.0V regulator for internal circuit power supply.
3. OSC
This is a precise wave oscillation circuit with operation frequency fixed to 1.0MHz.
4. Soft Start
This block does Soft Start to the output voltage of DC/DC converter, and prevents in-rush current during Start-up. Soft Start Time depends on application and start-condition because frequency fold-back function is built-in.
5. ERROR AMP
This is an error amplifier which detects output signal, and outputs PWM control signal. Internal reference voltage is set to 0.75V. Also, the BD9G102G-LB has internal phase compensated element between input and output.
6. ICOMP
This is a comparator that outputs PWM signal from current feed-back signal and error-amp output for current-mode.
7. Nch FET SW
This is a 45V/800mΩ Power Nch MOSFET SW that converts inductor current of DC/DC converter.
8. UVLO
This is a low voltage error prevention circuit.
This prevents internal circuit error during increase of power supply voltage and during decline of power supply voltage. It monitors VCC pin voltage and internal REG voltage, and when VCC voltage becomes 5.3V and below, it turns OFF all output FET and DC/DC converter's output, and Soft Start circuit resets.
Now this threshold has hysteresis of 200mV.
9. EN
If the voltage from this terminal is below 0.5V, IC operation is OFF. If it is between 0.5V and 1.8V, internal REG circuit turns ON. If it is greater than 1.8V(Typ), the IC is operational and a hysteresis generation current of 10 μA (Typ) is sourced from the EN terminal. To turn off the IC, source current should be removed.
When the situation without a signal to control EN terminal at the time of start up is assumed, pull down EN terminal by pull down resistor to prevent becoming the high impedance.
Arbitrary UVLO is possible by connecting EN terminal to a voltage divider from the input voltage.
10. TSD
Circuit for preventing malfunction at high Temperature.
When it detects an abnormal temperature, it turns OFF DC/DC Converter Output. The threshold of TSD has Hysteresis. When the temperature is decreased, the IC automatically returns to normal operation.
11. OVP
Over Voltage Protection.
Output voltage is monitored with FB terminal, and output FET is turned off when it becomes 113% of set-point voltage.

Absolute Maximum Ratings (Ta=25°C)

Parameter	Symbol	Rating	Unit
VCC to GND	V _{CC}	-0.3 to +45	V
BST to GND	V _{BST}	-0.3 to +52	V
BST to LX	ΔV _{BST}	7	V
EN to GND	V _{EN}	-0.3 to +45	V
LX to GND	V _{LX}	-0.3 to +45	V
FB to GND	V _{FB}	-0.3 to +7	V
High-side FET Drain Current	I _{DH}	I _{OCF}	A
Storage Temperature Range	T _{stg}	-55 to +150	°C
Junction Temperature	T _{Jmax}	150	°C

Caution 1: Operating the IC over the absolute maximum ratings may damage the IC. The damage can either be a short circuit between pins or an open circuit between pins and the internal circuitry. Therefore, it is important to consider circuit protection measures, such as adding a fuse, in case the IC is operated over the absolute maximum ratings.

Caution 2: Should by any chance the maximum junction temperature rating be exceeded the rise in temperature of the chip may result in deterioration of the properties of the chip. In case of exceeding this absolute maximum rating, design a PCB boards with thermal resistance taken into consideration by increasing board size and copper area so as not to exceed the maximum junction temperature rating.

Thermal Resistance ^(Note 1)

Parameter	Symbol	Thermal Resistance (Typ)		Unit
		1s ^(Note 3)	2s2p ^(Note 4)	
SSOP6				
Junction to Ambient	θ _{JA}	376.5	185.4	°C/W
Junction to Top Characterization Parameter ^(Note 2)	Ψ _{JT}	40	30	°C/W

(Note 1)Based on JESD51-2A(Still-Air).

(Note 2)The thermal characterization parameter to report the difference between junction temperature and the temperature at the top center of the outside surface of the component package.

(Note 3)Using a PCB board based on JESD51-3.

Layer Number of Measurement Board	Material	Board Size
Single	FR-4	114.3mm x 76.2mm x 1.57mmt

Top	
Copper Pattern	Thickness
Footprints and Traces	70μm

(Note 4)Using a PCB board based on JESD51-7.

Layer Number of Measurement Board	Material	Board Size
4 Layers	FR-4	114.3mm x 76.2mm x 1.6mmt

Top		2 Internal Layers		Bottom	
Copper Pattern	Thickness	Copper Pattern	Thickness	Copper Pattern	Thickness
Footprints and Traces	70μm	74.2mm x 74.2mm	35μm	74.2mm x 74.2mm	70μm

Recommended Operating Conditions

Parameter	Symbol	Min	Typ	Max	Unit
Input Voltage	V _{CC}	6	-	42	V
Output Voltage	V _{OUT}	0.75 ^(Note 5)	-	V _{CC} ×0.8	V
Output Current ^(Note 6)	I _{OUT}	-	-	500	mA
Input Capacitance	C _{IN}	2.2 ^(Note 7)	-	-	μF
Output Capacitance	C _{OUT}	22 ^(Note 8)	-	-	μF
Inductance	L	15 ^(Note 9)	-	-	μH
Operating Temperature	Topr	-40	-	+85	°C

(Note 5) Restricted by minimum duty = F_{SW} × Minimum-On Time (F: frequency; Minimum-On Time typ : 80ns)

If the voltage of V_{CC} × minimum duty is lower than 0.75V, this value is minimum output.

(Note 6) If the output Current is lower than ΔIL/2, there is possibility that BD9G102G-LB operates in the PFM mode. (ΔIL:Output ripple current)
For improving the stability, it's recommended to load current more than ΔIL/2 during normal operation.

(Note 7) The capacitance is selected in the range including temperature characteristics and bias voltage effect.Refer to P.19.

(Note 8) The capacitance is selected in the range including temperature characteristics and bias voltage effect.Refer to P.18.

(Note 9) Restricted by output voltage setting.Refer to P.18.

Timing Chart

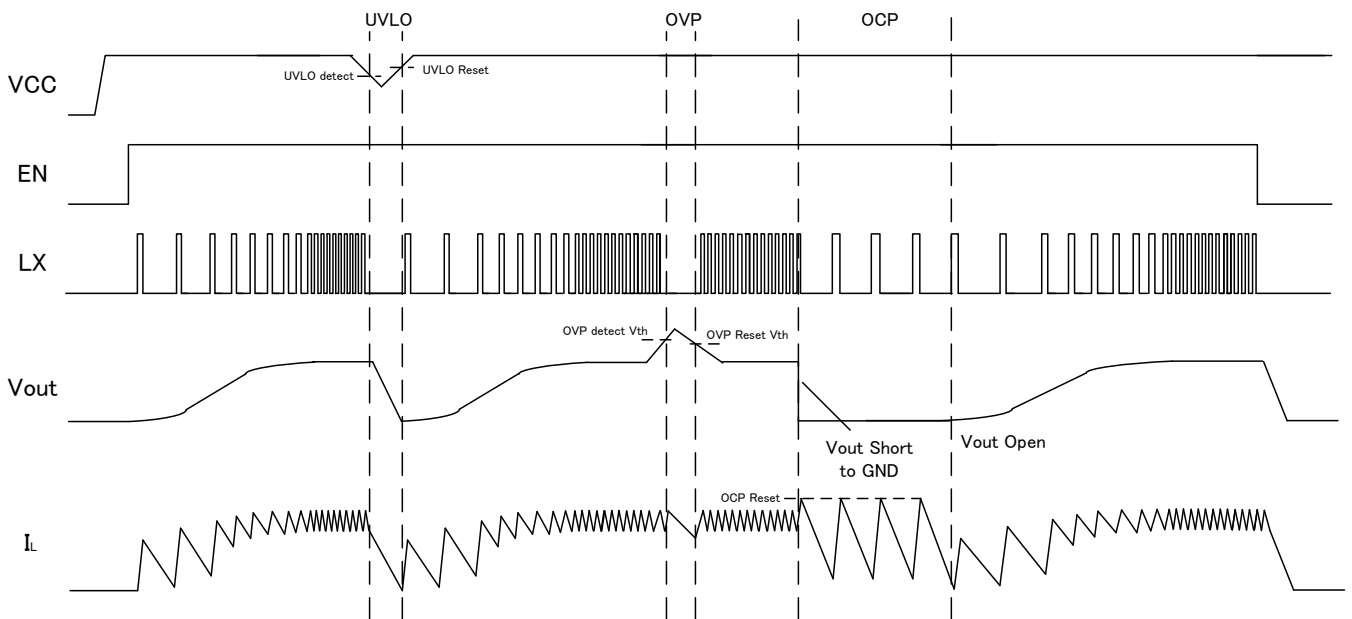

Figure 4. Timing Chart

Electrical Characteristics (Unless otherwise specified Ta=25°C, VCC=18V, VOUT=5.0V, EN=3V)

Parameter	Symbol	Limit			Unit	Conditions
		Min	Typ	Max		
Circuit Current						
Shutdown supply current	I _{ST}	-	0	10	μA	EN = 0 V
Operating non-switching supply current	I _{CC}	-	0.5	1.0	mA	FB = 1.2 V (Non-switching)
Under voltage lockout						
Detect threshold voltage	V _{UV}	5.0	5.3	5.6	V	VCC falling
Hysteresis width	V _{UVHY}	-	200	400	mV	
Oscillator						
Oscillating frequency	F _{SW}	0.80	1.00	1.20	MHz	
Error amplifier						
FB Pin Reference Voltage	V _{FBN}	0.735	0.750	0.765	V	Ta=25°C
	V _{FBA}	0.730	0.750	0.770	V	Ta=-40°C to 85°C
FB Pin Bias Current	I _{FB}	-1.0	0	+1.0	μA	V _{FB} = 0 V
High-side MOSFET						
On resistance	R _{onH}	-	800	-	mΩ	
Minimum On Time	T _{MIN}	-	80	-	ns	
Over current detect threshold	I _{OC}	0.8	1.2	-	A	
EN control						
EN inner Reg threshold	V _{ENOF}	-0.3	-	+0.5	V	Shut down
	V _{ENON1}	0.5	-	1.5	V	Non switching mode
EN pin output active threshold	V _{ENON2}	1.7	1.8	1.9	V	Output active
EN pin current	I _{EN}	-12.0	-10.0	-8.0	μA	V _{EN} = 3V

Typical Performance Characteristics (Unless otherwise specified, Ta=25°C, VCC=24V, VOUT=5V, EN=3V)

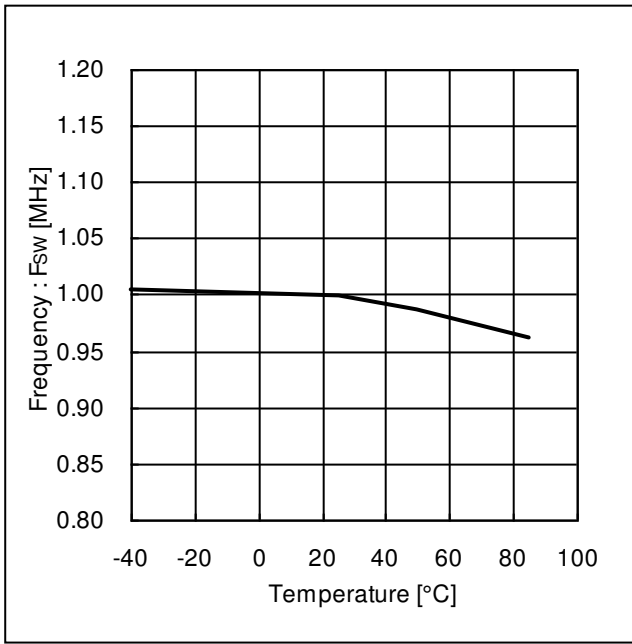

Figure 5. Oscillator Frequency - Temperature

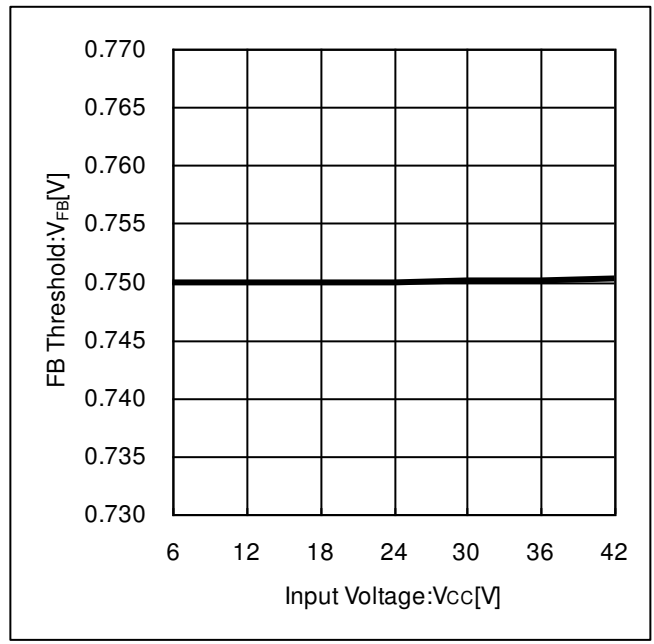

Figure 6. FB Threshold Voltage – Input Voltage

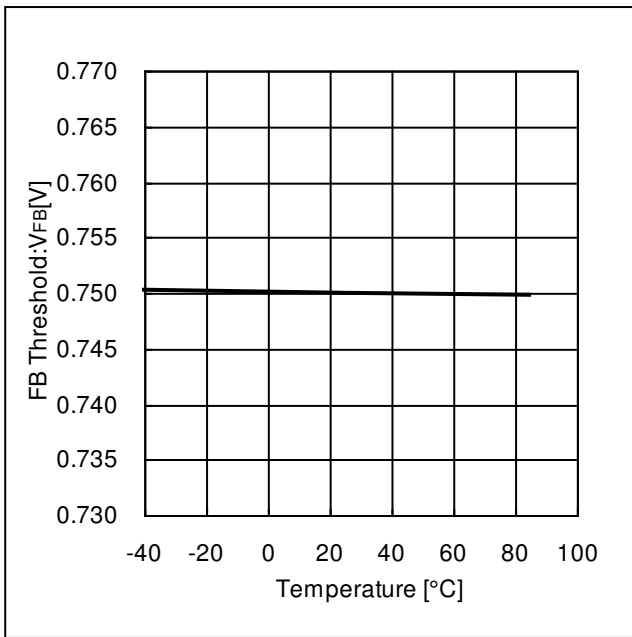

Figure 7. FB Threshold Voltage - Temperature

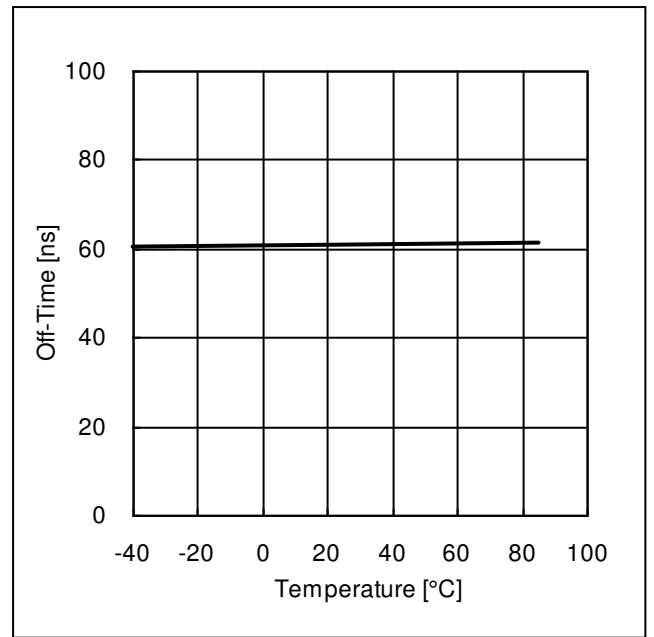

Figure 8. PWMCLK Off-Time - Temperature

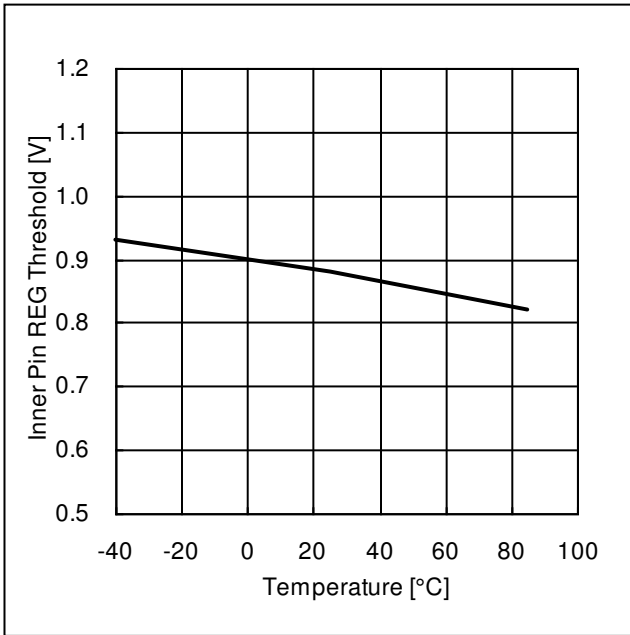

Figure 9. EN Inner REG ON Threshold - Temperature

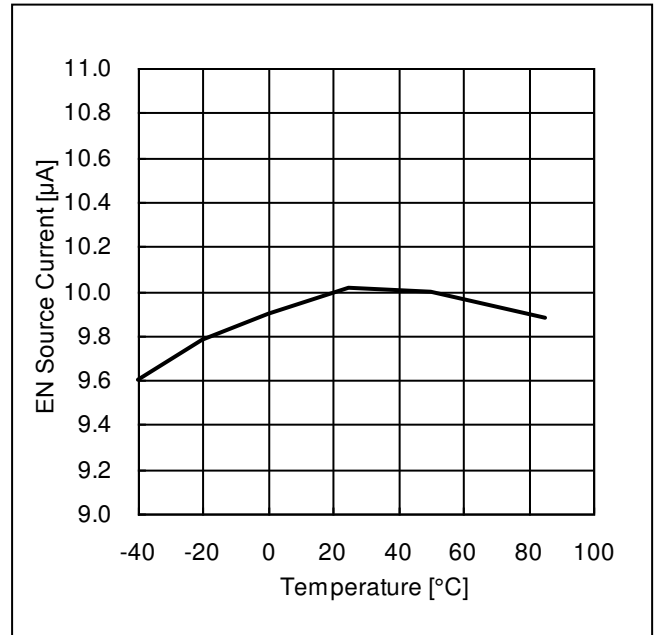

Figure 10. EN Source Current - Temperature

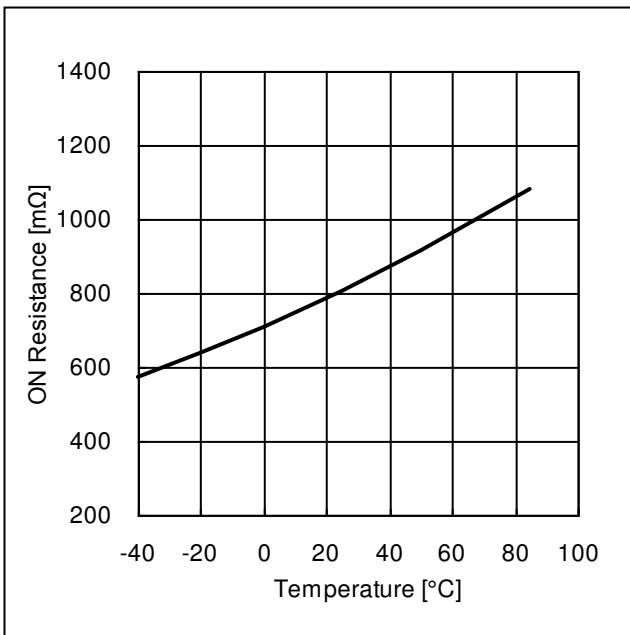

Figure 11. NMOS ON Resistance - Temperature

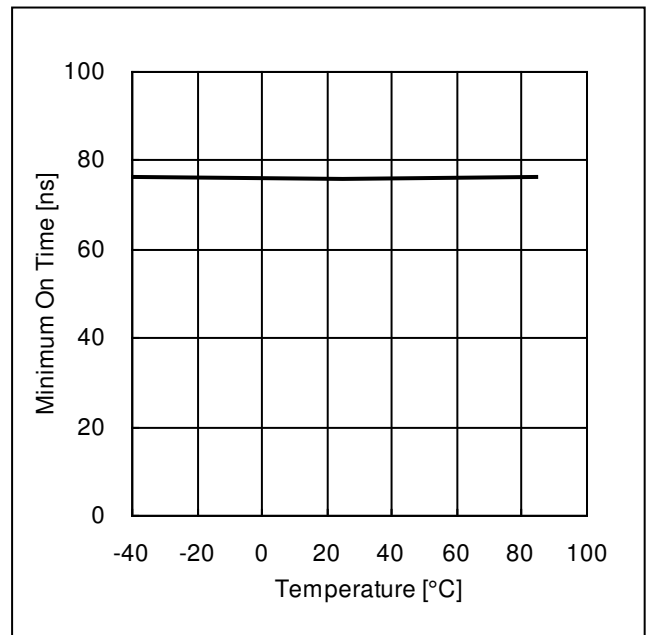

Figure 12. Minimum ON Time - Temperature

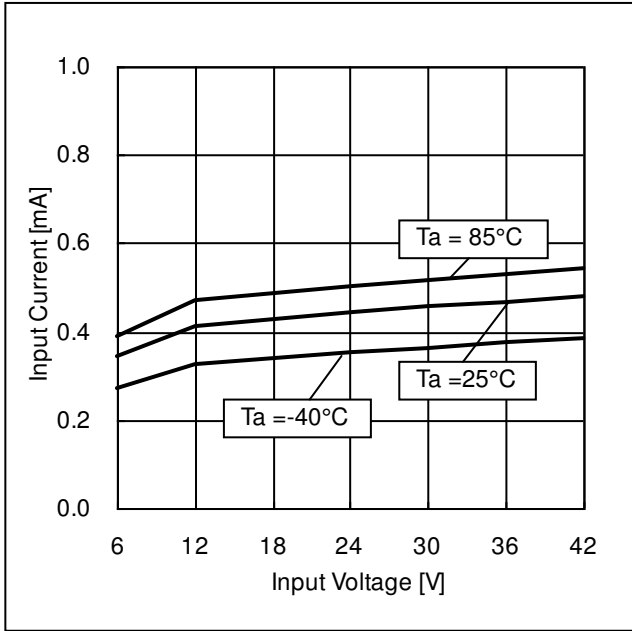

Figure 13. Operating Current – Input Voltage

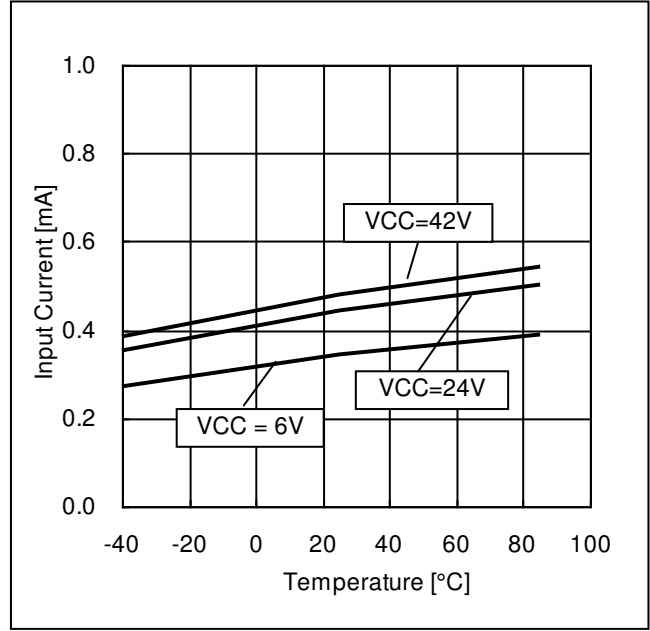

Figure 14. Operating Current – Temperature

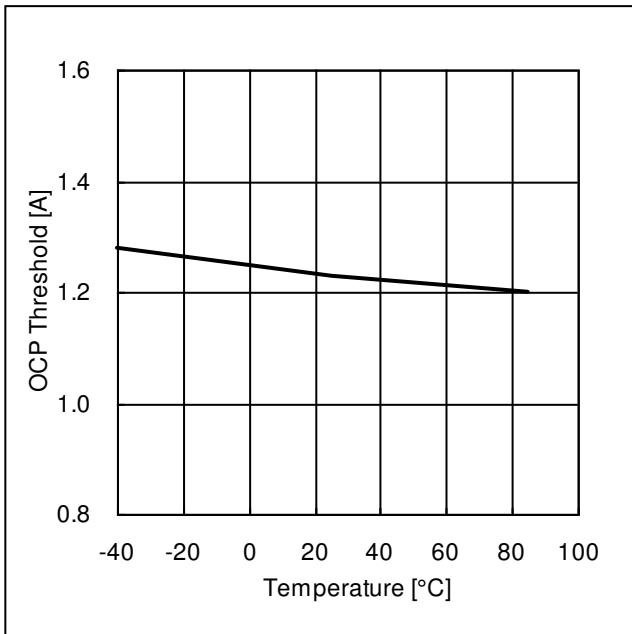

Figure 15. OCP Detect Current - Temperature

Reference Characteristics of Typical Application Circuits

$V_{OUT}=3.3V$

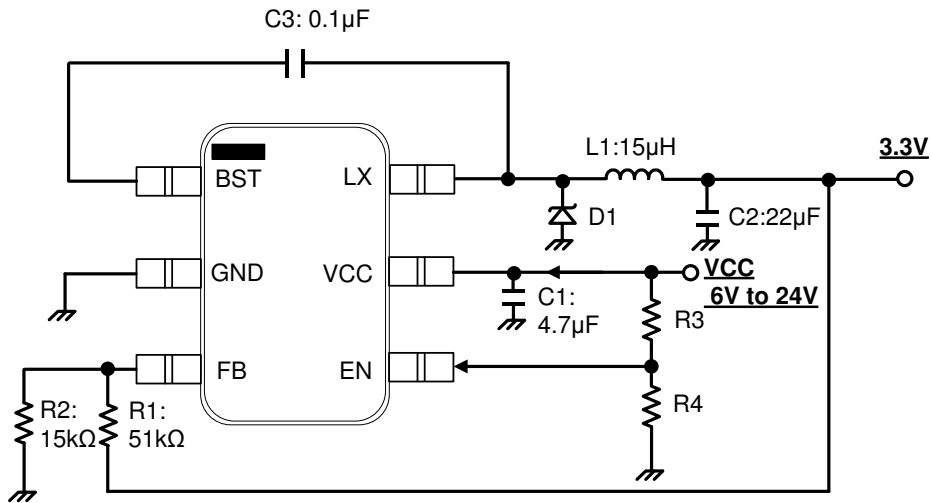

Figure 16. Typical Application Circuit ($V_{OUT}=3.3V$)

Parts	L1	TDK	CLF5030NIT-150M-D	15µH
	C1	Murata	GRM32EB31H475KA87	4.7µF/50V
	C2	Murata	GRM31CR61E226ME15	22µF/25V
	C3	Murata	GRM155R71E104ME14	0.1µF/25V
	D1	ROHM	RB060MM-60	

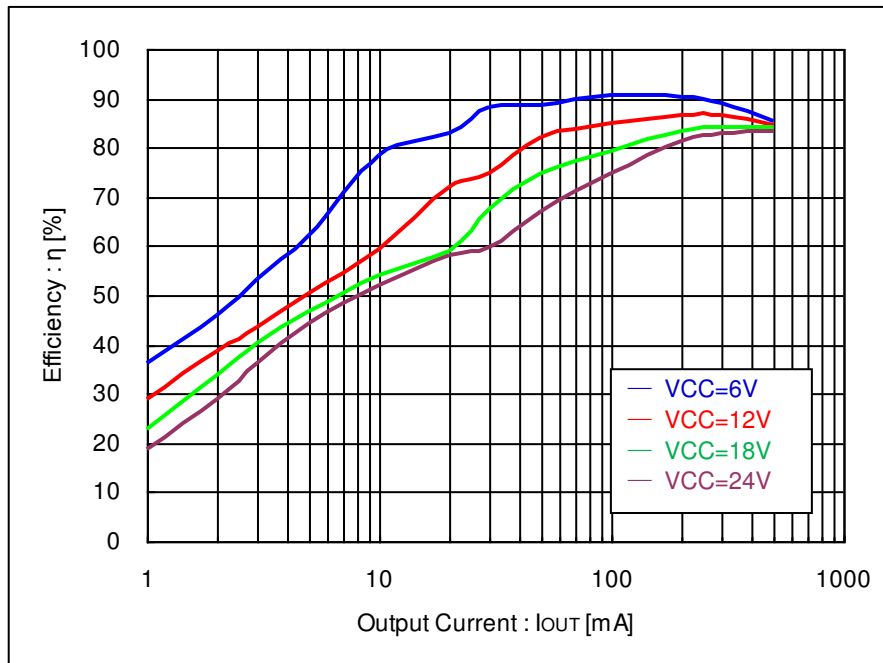

Figure 17. Efficiency-Output Current ($V_{OUT}=3.3V$)

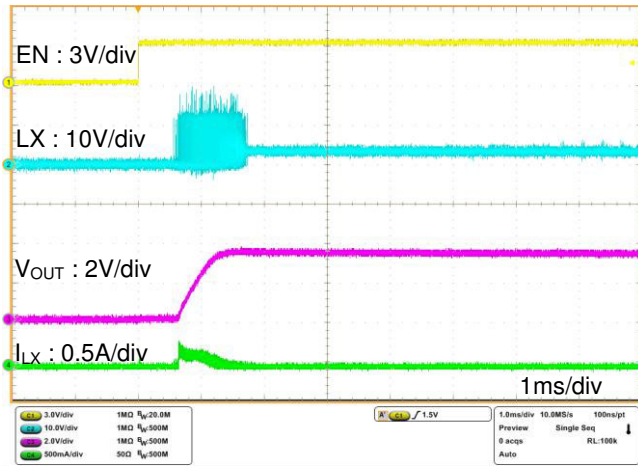

Figure 18. Start-up Characteristics
(VCC=12V, IOUT=0mA, VOUT=3.3V)

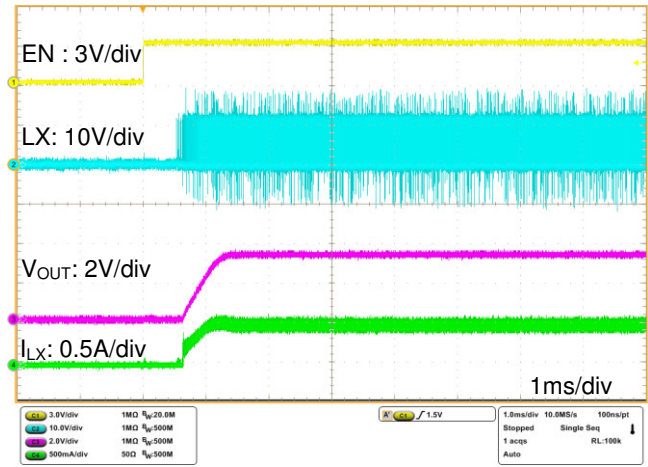

Figure 19. Start-up Characteristics
(VCC=12V, IOUT=500mA, VOUT=3.3V)

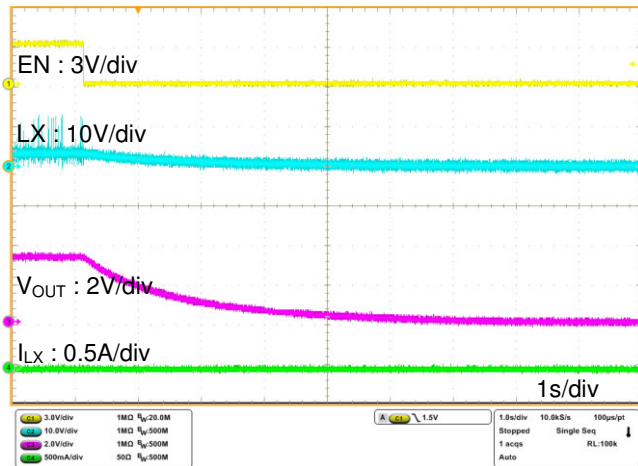

Figure 20. Shut-down Characteristics
(VCC=12V, IOUT=0mA, VOUT=3.3V)

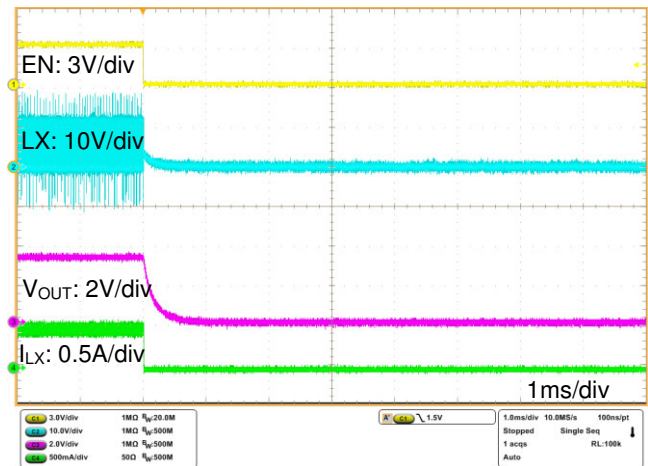

Figure 21. Shut-down Characteristics
(VCC=12V, IOUT=500mA, VOUT=3.3V)

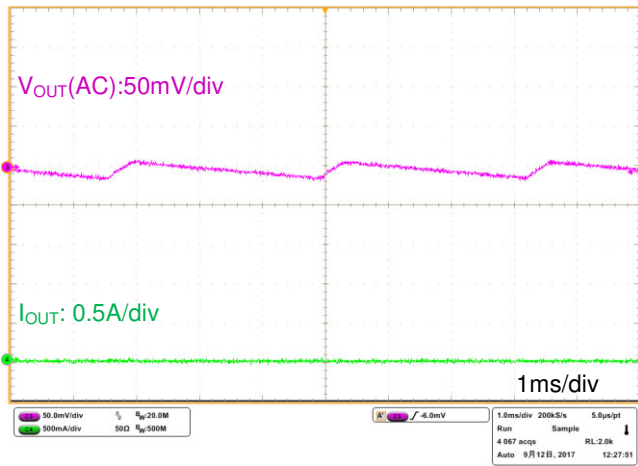

Figure 22 V_{OUT} Ripple
($V_{CC}=12V$, $I_{OUT}=0mA$, $V_{OUT}=3.3V$)

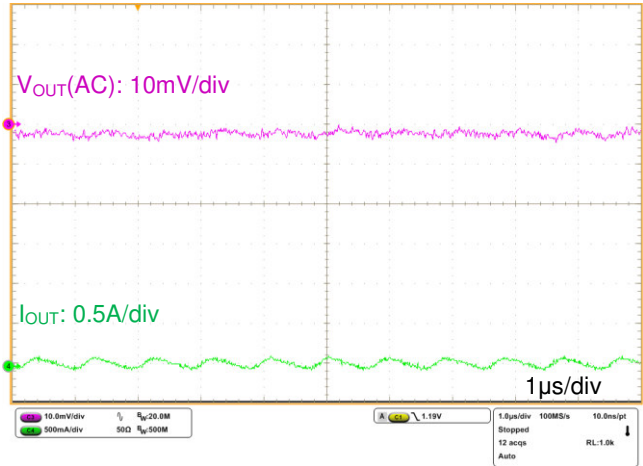

Figure 23 V_{OUT} Ripple
($V_{CC}=12V$, $I_{OUT}=50mA$, $V_{OUT}=3.3V$)

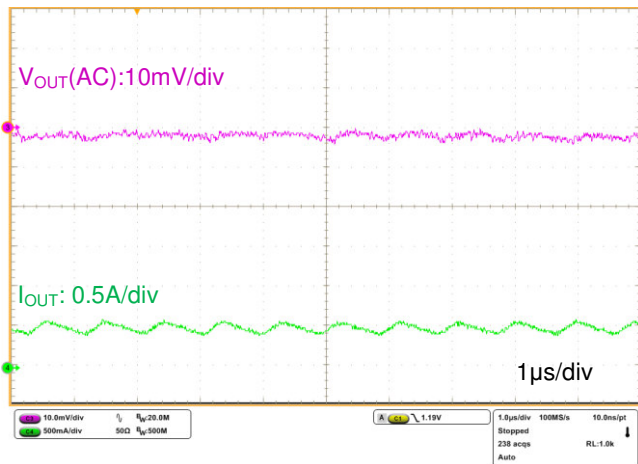

Figure 24 V_{OUT} Ripple
($V_{CC}=12V$, $I_{OUT}=500mA$, $V_{OUT}=3.3V$)

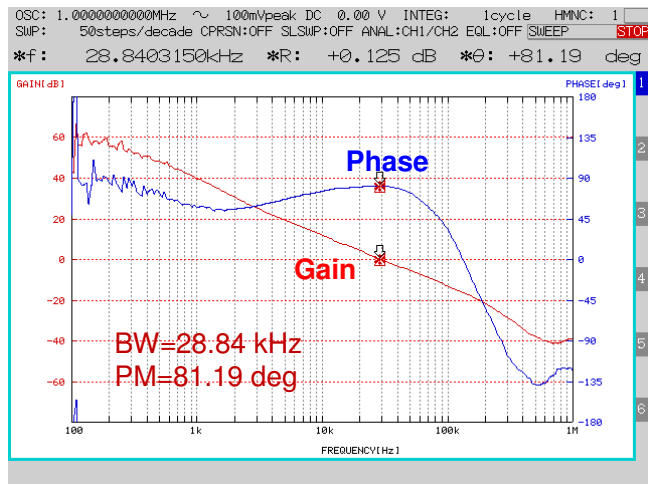

Figure 25 Frequency Response
($V_{CC}=12V$, $I_{OUT}=100mA$, $V_{OUT}=3.3V$)

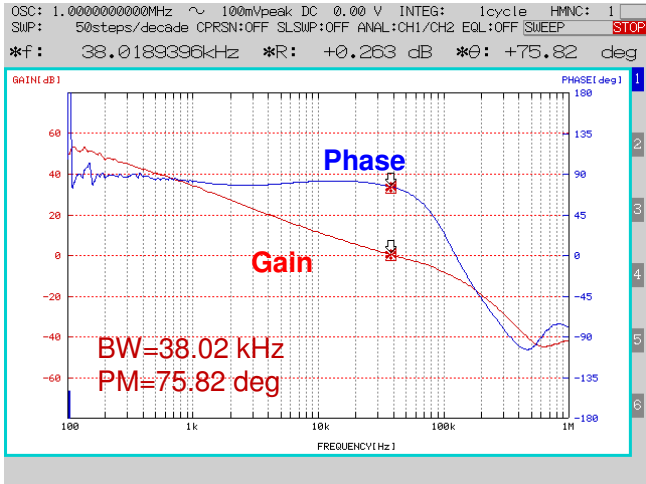

Figure 26 Frequency Response
 (V_{CC}=12V, I_{OUT}=500mA, V_{OUT}=3.3V)

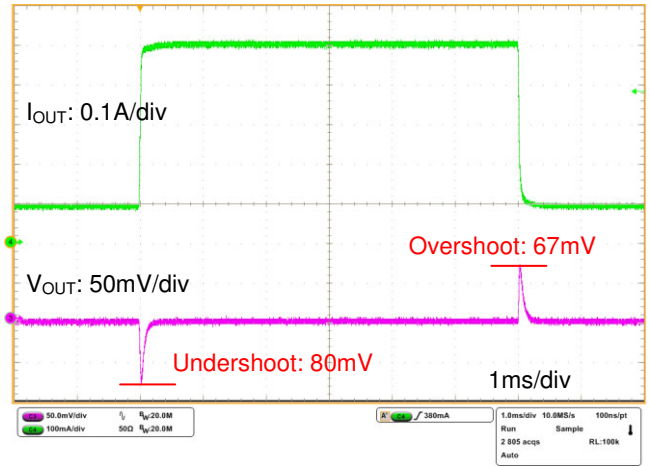

Figure 27 Load Response
 (V_{CC}=12V, I_{OUT}=100mA↔500mA, V_{OUT}=3.3V)

Reference Characteristics of Typical Application Circuits

V_{OUT} = 5.0V

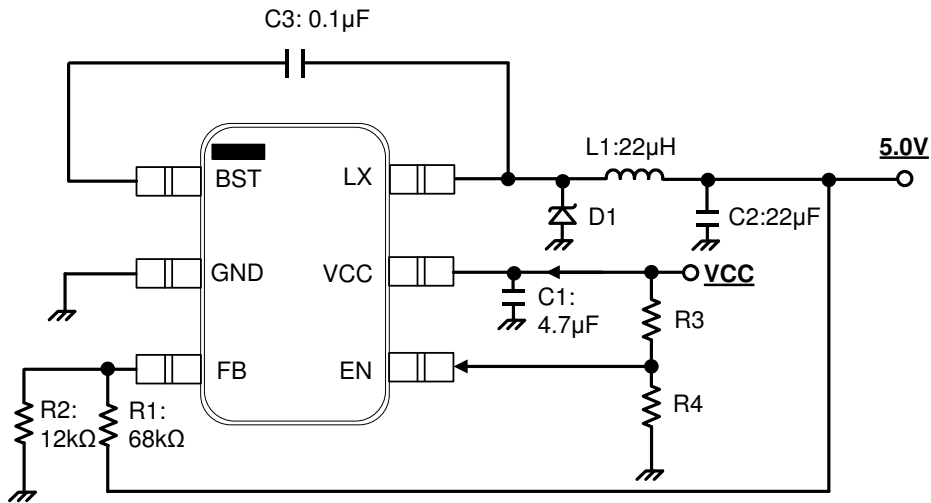

Figure 28 Typical Application Circuit (V_{OUT}=5V)

Parts	L1	:	TDK	CLF5030NIT-220M-D	22μH
	C1	:	Murata	GRM32EB31H475KA87	4.7μF/50V
	C2	:	Murata	GRM31CR61E226ME15	22μF/25V
	C3	:	Murata	GRM155R71E104ME14	0.1μF/25V
	D1	:	ROHM	RB060MM-60	

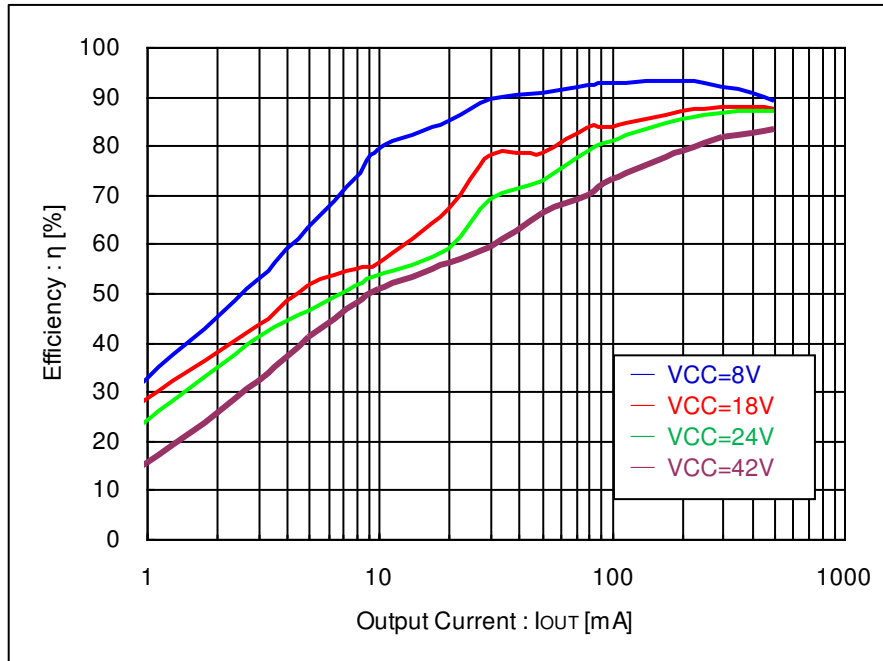

Figure 29 Efficiency-Output Current (V_{OUT}=5V)

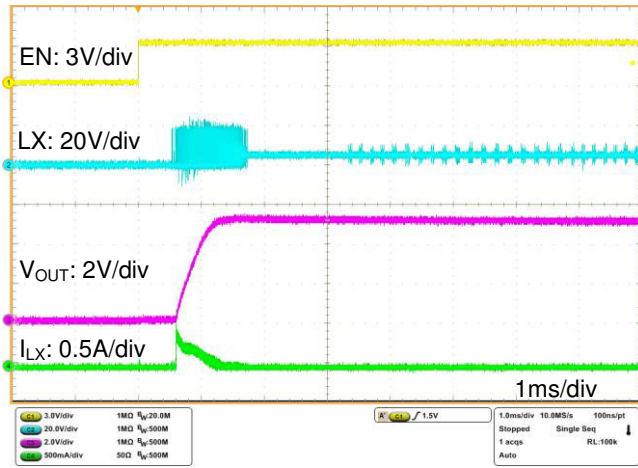

Figure 30 start-up Characteristics
(VCC=18V, IOUT=0mA, VOUT=5V)

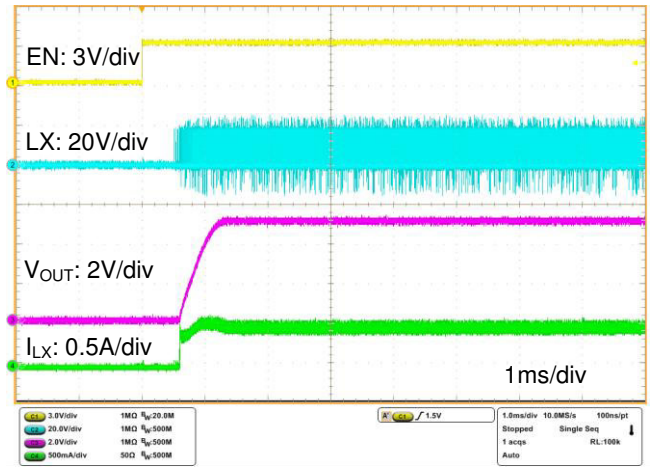

Figure 31 Start-up Characteristics
(VCC=18V, IOUT=500mA, VOUT=5V)

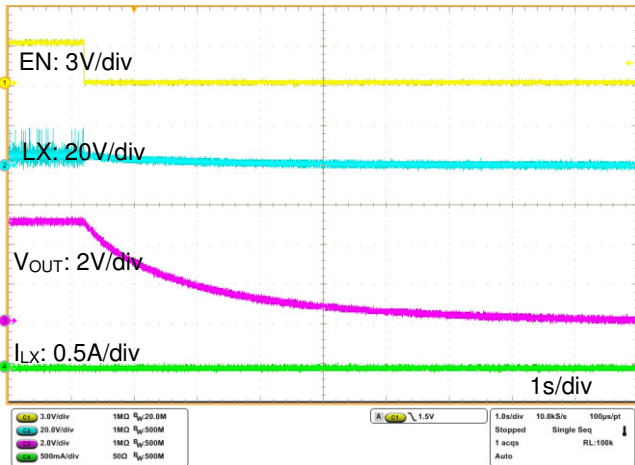

Figure 32 Shut-down Characteristics
(VCC=18V, IOUT=0mA, VOUT=5V)

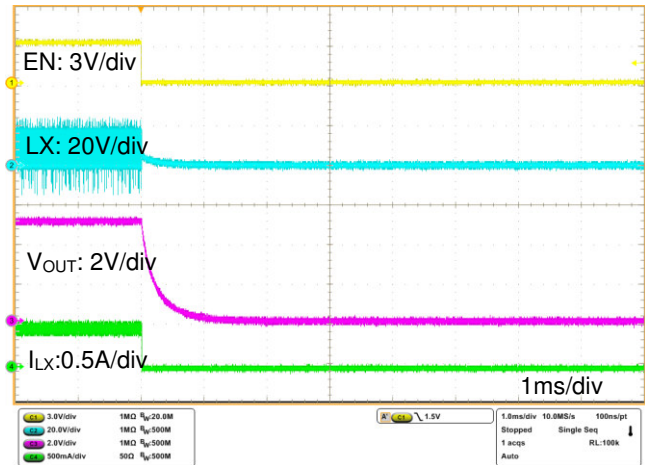

Figure 33 Shut-down Characteristics
(VCC=18V, IOUT=500mA, VOUT=5V)

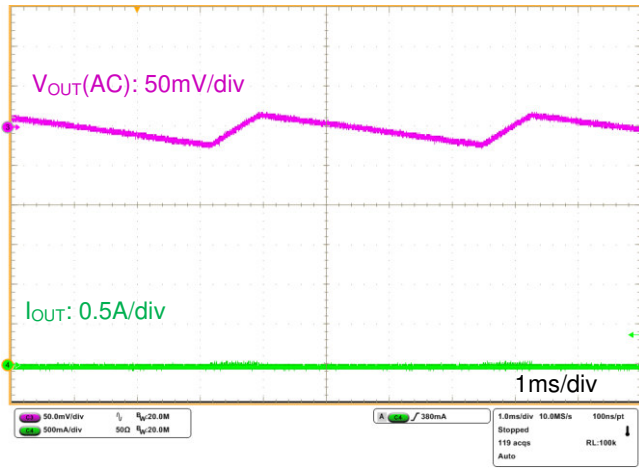

Figure 34 V_{OUT} Ripple
($V_{CC}=18V$, $I_{OUT}=0mA$; $V_{OUT}=5V$)

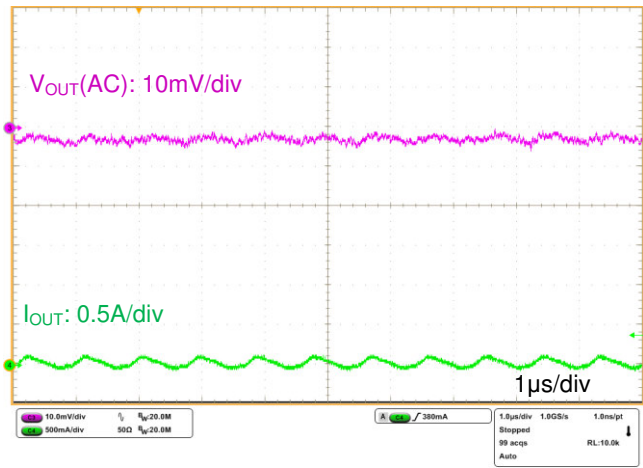

Figure 35. V_{OUT} Ripple
($V_{CC}=18V$, $I_{OUT}=50mA$, $V_{OUT}=5V$)

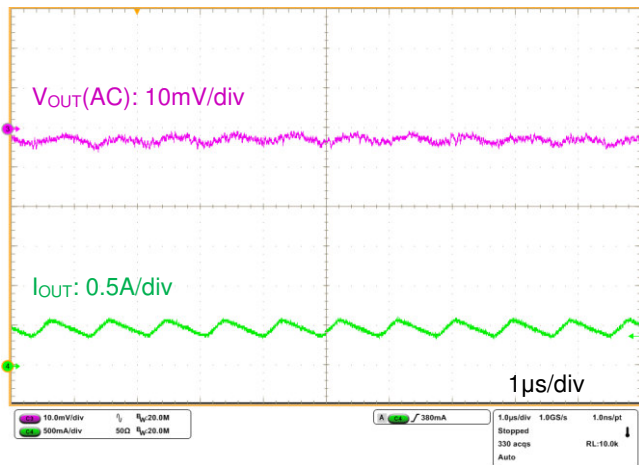

Figure 36. Frequency Response
($V_{CC}=18V$, $I_{OUT}=500mA$, $V_{OUT}=5V$)

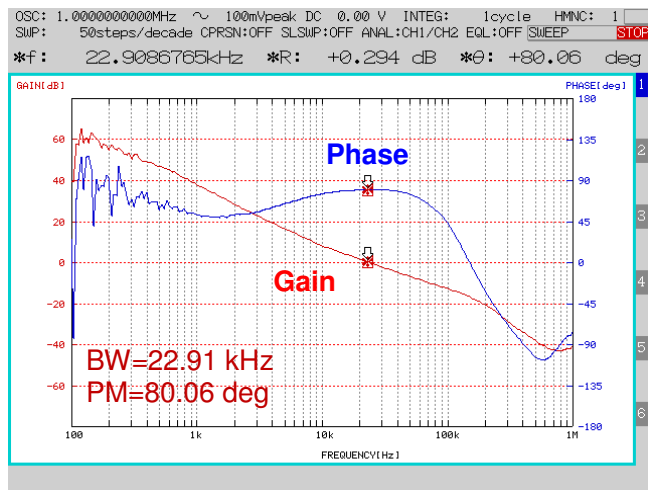

Figure 37. Frequency Response
($V_{CC}=18V$, $I_{OUT}=100mA$, $V_{OUT}=5V$)

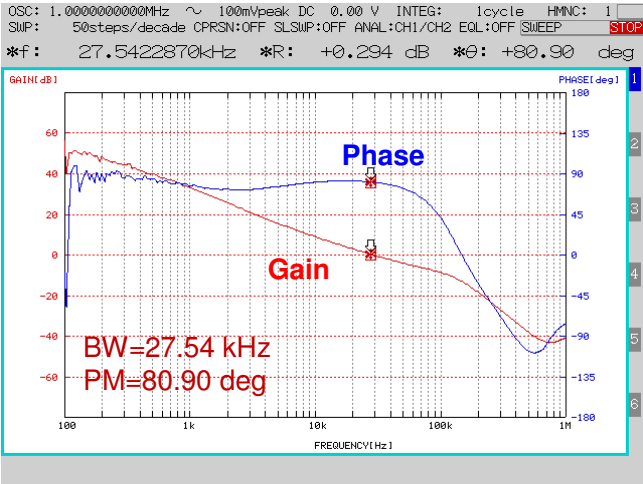

Figure 38. Frequency Response
 (V_{CC}=18V, I_{OUT}=500mA, V_{OUT}=5V)

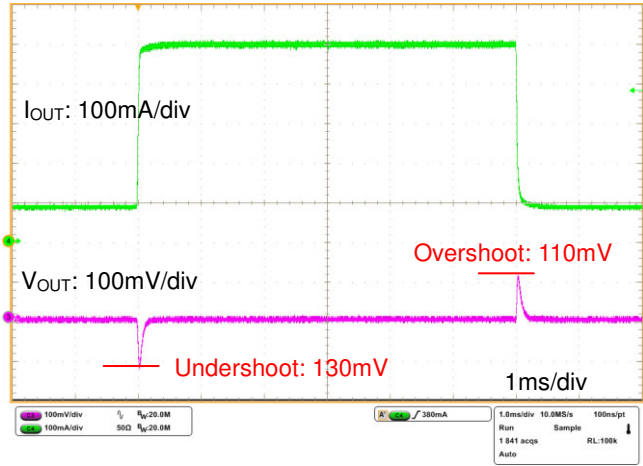

Figure 39. Load Response
 (V_{CC}=18V, V_{OUT}=5V, I_{OUT}=100mA↔500mA)

Selection of Components Externally Connected

(1) Inductors

Something of the shield type that fulfills the current rating (Current value peak below), with low DCR is recommended. Value of Inductance influences Inductor Ripple Current and becomes the cause of Output Ripple. In the same way as the formula below, this Ripple Current can be made small for as big as the L value of Coil or as high as the Switching Frequency.

$$I_{peak} = I_{OUT} + \frac{\Delta I_L}{2} \quad (1)$$

$$\Delta I_L = \frac{V_{CC} - V_{OUT}}{L} \times \frac{V_{OUT}}{V_{CC}} \times \frac{1}{f} \quad (2)$$

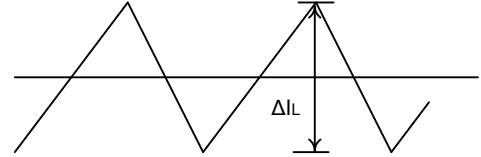

Figure 40. Inductor Current

Where:

ΔI_L is the Output Ripple Current.

V_{CC} is the Input Voltage.

V_{OUT} is the Output Voltage.

f is the Switching Frequency.

Recommended Inductor

TDK CLF5030NIT-D Series

When the output setting voltage is high and a duty cycle greater than 50%, there is possibility of occurring sub-harmonic oscillation. Please design the value of Inductance that will not cause the IC and the system to malfunction by examining carefully all relevant factors and conditions. The minimum value of inductance in the case of a duty cycle is greater than 50% is shown in the following figure.

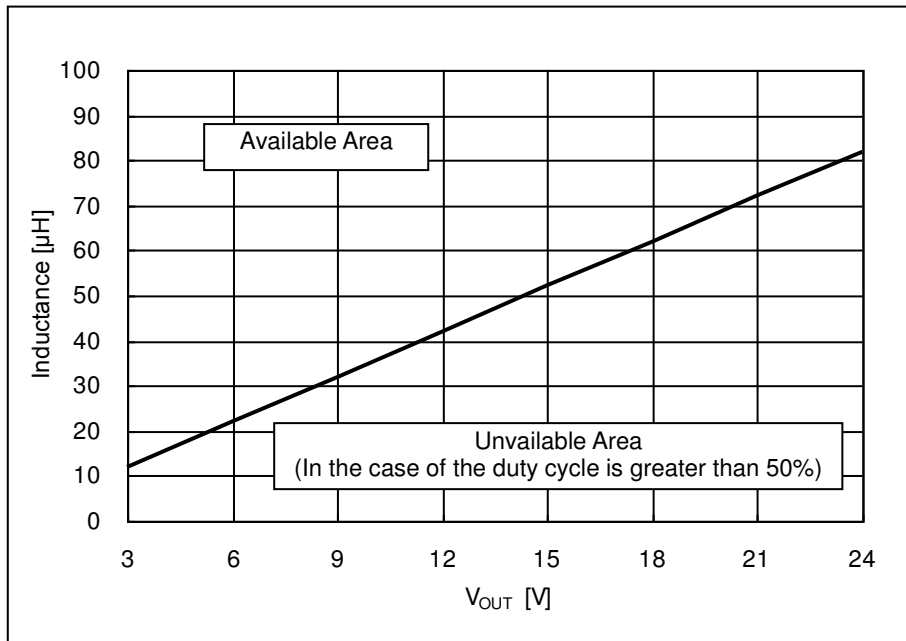

Figure 41. Recommended V_{OUT} vs Inductance

⊗When current that exceeds Coil rating flows to the coil, the Coil causes a Magnetic Saturation, and there are cases wherein a decline in efficiency, oscillation of output happens. Please have sufficient margin and select so that Peak Current does not exceed Rating Current of Coil.

(2) Output Capacitor

In order for capacitor to be used in output to reduce output ripple, Low ceramic capacitor of ESR is recommended. Also, for capacitor rating, on top of putting into consideration DC Bias characteristics, please use something whose maximum rating has sufficient margin with respect to the Output Voltage. The output ripple voltage can be estimated by the following formula.

$$V_{Ripple} = \Delta I_L \times \frac{1}{2\pi \times f \times C_{OUT}} + \Delta I_L \times R_{ESR} \quad (3)$$

The actual value of the output capacitor is not critical, but some practical limits do exist. Consider the relationship between the crossover frequency of the design and LC corner frequency of the output filter. In general, it is desirable to keep the crossover frequency at less than 1/20 of the switching frequency. With high switching frequencies such as the 1.0MHz frequency of this design, internal circuit limitations of the BD9G102G-LB limit the practical maximum crossover frequency to about 50kHz. In general, the crossover frequency should be higher than the corner frequency determined by the load impedance and the output capacitor. This limits the minimum capacitor value for the output filter to:

$$C_{OUT.min} = \frac{1}{2\pi \times R_{Load} \times fc_{max}} \quad (4)$$

Where:

R_{Load} is the output load resistance.

fc_{max} is the maximum crossover frequency.

Please design in a way that it is held within Capacity Ripple Voltage.

In the BD9G102G-LB, it is recommended a ceramic capacitor more than 22 μ F.

(3) Output Voltage Setting

ERROR AMP internal Standard Voltage is 0.75V.

Output Voltage is determined as seen in (5) formula

$$V_{OUT} = \frac{R1 + R2}{R2} \times 0.75 \quad (5)$$

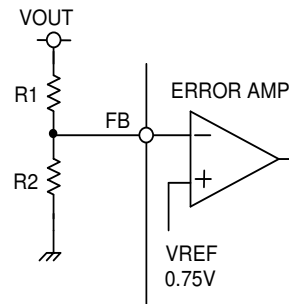

Figure 42. Output Voltage

(4) Bootstrap Capacitor

Please connect from 0.01 μ F to 0.47 μ F (Ceramic Capacitor) between BST Pin and LX Pin.

(5) Catch Diode

The BD9G102G-LB is designed to operate using an external catch diode between LX and GND. The selected diode must meet the absolute maximum ratings for the application: Reverse voltage must be higher than the maximum voltage at the LX pin, which is $V_{CCMAX} + 0.5$ V. Peak current must be greater than $I_{OUTMAX} + 1/2\Delta I_L$. Forward voltage drop should be small for higher efficiencies. It is important to note that the catch diode conduction time is typically longer than the high-side FET on time, so attention paid to diode parameters can make a marked improvement in overall efficiency. Additionally, check that the device chosen is capable of dissipating the power losses. It's necessary to use schottky barrier diode with the BD9G102G-LB.

(6) Input Capacitor

The BD9G102G-LB requires an input capacitor for decoupling and depending on the application. Use low ESR capacitors for the best performance. Ceramic capacitors are preferred, but low-ESR electrolytic capacitors may also suffice. Please place this capacitor as possible as close to the VCC pin. In the BD9G102G-LB, it is recommended a ceramic capacitor more than 2.2 μ F. When using ceramic capacitors, make sure that they have enough capacitance to provide sufficient charge to prevent excessive voltage ripple at input. The input voltage ripple caused by capacitance can be estimated by:

$$\Delta V_{CC_Ripple} = \frac{I_{OUT}}{f \times C_{VCC}} \times \frac{V_{OUT}}{V_{CC}} \times \left[1 - \frac{V_{OUT}}{V_{CC}} \right] \quad (6)$$

Since the input capacitor (C_{VCC}) absorbs the input switching current it requires an adequate ripple current rating. The RMS current in the input capacitor can be estimated by:

$$I_{CVCC} = I_{OUT} \times \sqrt{\frac{V_{OUT}}{V_{CC}} \times \left[1 - \frac{V_{OUT}}{V_{CC}} \right]} \quad (7)$$

The worst case condition occurs at $V_{CC} = 2V_{OUT}$, where

$$I_{CVCC,max} = \frac{I_{OUT}}{2} \quad (8)$$

(7) External UVLO Threshold

The high precision reset function is built in EN terminal of BD9G102G-LB, and arbitrary low-voltage malfunction prevention setup is possible by connecting EN pin to resistance of input voltage. When you use, please set R3 and R4 to arbitrary UVLO threshold level(V_{UV}) and hysteresis(V_{UVHY}) like below.

$$R3 = \frac{V_{UVHY}}{I_{EN}} \quad (9)$$

$$R4 = \frac{V_{EN} \times R3}{V_{UV} - V_{EN}} \quad (10)$$

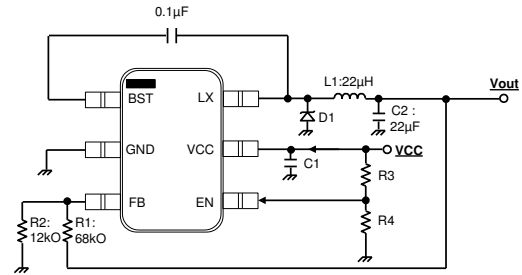

Figure 43. External UVLO Threshold Setting

I_{EN} : EN pin source current 10µA(typ) V_{EN} : EN pin output on threshold 1.8V(typ)

As an example in typical sample, when VCC voltage which IC turned on 13V, hysteresis width 1V, the resistance divider set to R3=100kΩ, R4=16kΩ.

(8) Recommended Input Voltage(vs. V_{OUT})

For improving the stability, it's recommended to operate BD9G102G-LB in the PWM mode. The V_{out} voltage operating under PWM mode is limited by min on time(typ: 80ns). When BD9G102G-LB operates on the condition of $V_{IN} \gg V_{OUT}$ and operates PFM mode, there is possibility of oscillating. For considering the stability under PFM and PWM mode under all condition, it's recommended to set the V_{CC} smaller than V_{CC_max} , and V_{CC_max} is defined as below based on V_{OUT} .

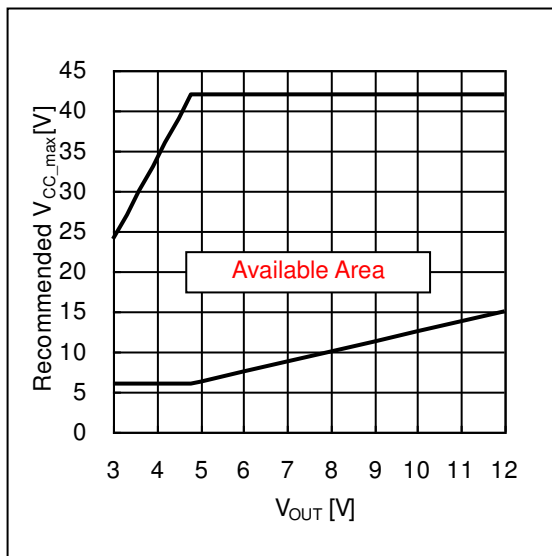

V_{OUT} [V]	Recommended V_{CC_max} [V]
3.0	24
3.3	27
4.2	36
4.8	42
5.0	42
8.0	42
12.0	42

Figure 44. Recommended V_{CC_max} vs V_{OUT}

Cautions on PCB board layout

Layout is a critical portion of good power supply design. There are several signals paths that conduct fast changing currents or voltages that can interact with stray inductance or parasitic capacitance to generate noise or degrade the power supplies performance. To help eliminate these problems, the VCC pin should be bypassed to ground with a low ESR ceramic bypass capacitor with B dielectric. Care should be taken to minimize the loop area formed by the bypass capacitor connections, the VCC pin, and the anode of the catch diode. See Fig.45 for a PCB layout example.

In the BD9G102G-LB, since the LX connection is the switching node, the catch diode and output inductor should be located close to the LX pins, and the area of the PCB conductor minimized to prevent excessive capacitive coupling. And GND area should be connected directly to power GND for avoiding the external connect which causes the different GND voltage. The additional external components can be placed approximately as shown.

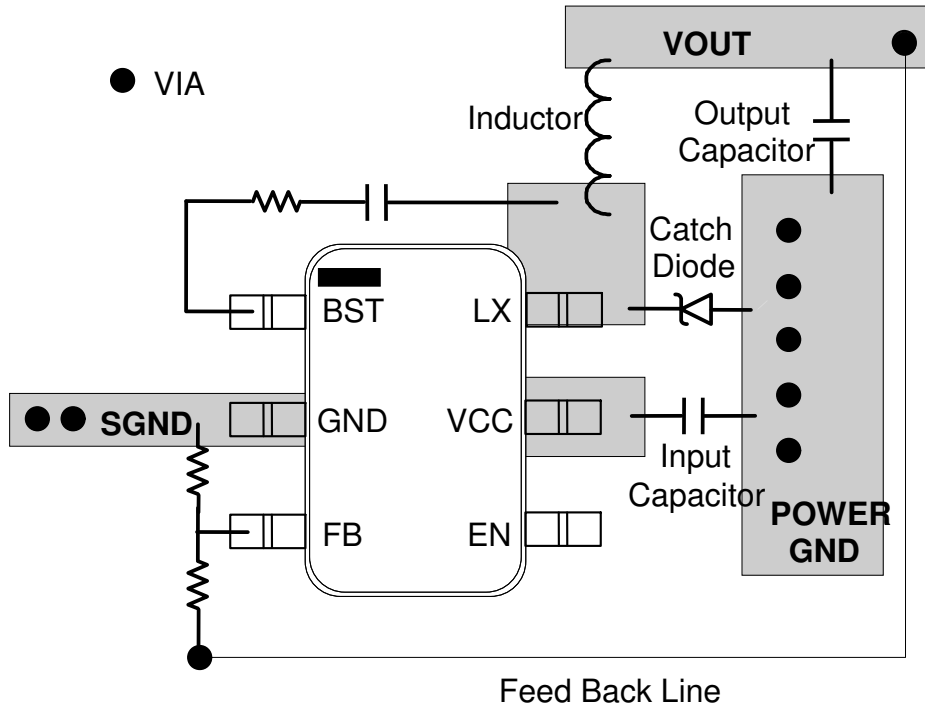

Figure 45. Reference PCB

I/O Equivalent Circuit

Pin. No	Pin Name	Pin Equivalent Circuit	Pin. No	Pin Name	Pin Equivalent Circuit
6 2 1 5	LX GND BST VCC		4	EN	
3	FB				

Figure 46. I/O Equivalent Circuit

Operational Notes**1. Reverse Connection of Power Supply**

Connecting the power supply in reverse polarity can damage the IC. Take precautions against reverse polarity when connecting the power supply, such as mounting an external diode between the power supply and the IC's power supply pins.

2. Power Supply Lines

Design the PCB layout pattern to provide low impedance supply lines. Furthermore, connect a capacitor to ground at all power supply pins. Consider the effect of temperature and aging on the capacitance value when using electrolytic capacitors.

3. Ground Voltage

Ensure that no pins are at a voltage below that of the ground pin at any time, even during transient condition. However, pins that drive inductive loads (e.g. motor driver outputs, DC-DC converter outputs) may inevitably go below ground due to back EMF or electromotive force. In such cases, the user should make sure that such voltages going below ground will not cause the IC and the system to malfunction by examining carefully all relevant factors and conditions such as motor characteristics, supply voltage, operating frequency and PCB wiring to name a few.

4. Ground Wiring Pattern

When using both small-signal and large-current ground traces, the two ground traces should be routed separately but connected to a single ground at the reference point of the application board to avoid fluctuations in the small-signal ground caused by large currents. Also ensure that the ground traces of external components do not cause variations on the ground voltage. The ground lines must be as short and thick as possible to reduce line impedance.

5. Recommended Operating Conditions

The function and operation of the IC are guaranteed within the range specified by the recommended operating conditions. The characteristic values are guaranteed only under the conditions of each item specified by the electrical characteristics.

6. Inrush Current

When power is first supplied to the IC, it is possible that the internal logic may be unstable and inrush current may flow instantaneously due to the internal powering sequence and delays, especially if the IC has more than one power supply. Therefore, give special consideration to power coupling capacitance, power wiring, width of ground wiring, and routing of connections.

7. Operation Under Strong Electromagnetic Field

Operating the IC in the presence of a strong electromagnetic field may cause the IC to malfunction.

8. Testing on Application Boards

When testing the IC on an application board, connecting a capacitor directly to a low-impedance output pin may subject the IC to stress. Always discharge capacitors completely after each process or step. The IC's power supply should always be turned off completely before connecting or removing it from the test setup during the inspection process. To prevent damage from static discharge, ground the IC during assembly and use similar precautions during transport and storage.

9. Inter-pin Short and Mounting Errors

Ensure that the direction and position are correct when mounting the IC on the PCB. Incorrect mounting may result in damaging the IC. Avoid nearby pins being shorted to each other especially to ground, power supply and output pin. Inter-pin shorts could be due to many reasons such as metal particles, water droplets (in very humid environment) and unintentional solder bridge deposited in between pins during assembly to name a few.

10. Unused Input Pins

Input pins of an IC are often connected to the gate of a MOS transistor. The gate has extremely high impedance and extremely low capacitance. If left unconnected, the electric field from the outside can easily charge it. The small charge acquired in this way is enough to produce a significant effect on the conduction through the transistor and cause unexpected operation of the IC. So unless otherwise specified, unused input pins should be connected to the power supply or ground line.

11. Regarding the Input Pin of the IC

This monolithic IC contains P+ isolation and P substrate layers between adjacent elements in order to keep them isolated. P-N junctions are formed at the intersection of the P layers with the N layers of other elements, creating a parasitic diode or transistor. For example (refer to figure below):

When $GND > Pin A$ and $GND > Pin B$, the P-N junction operates as a parasitic diode.

When $GND > Pin B$, the P-N junction operates as a parasitic transistor.

Parasitic diodes inevitably occur in the structure of the IC. The operation of parasitic diodes can result in mutual interference among circuits, operational faults, or physical damage. Therefore, conditions that cause these diodes to operate, such as applying a voltage lower than the GND voltage to an input pin (and thus to the P substrate) should be avoided.

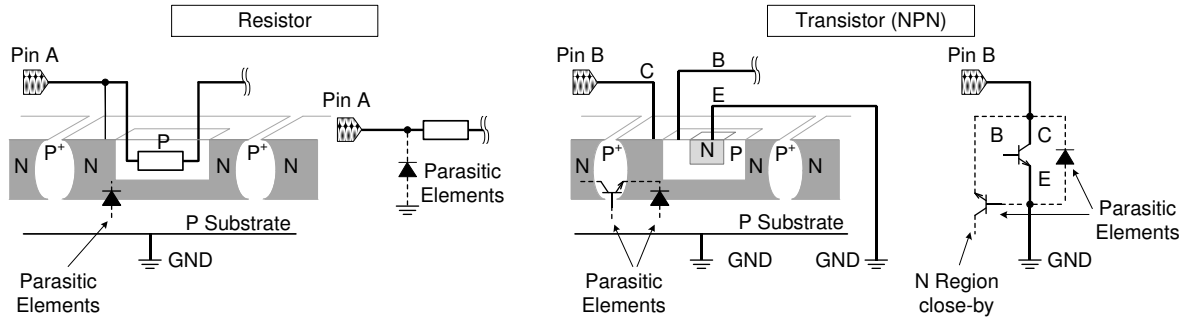

Figure 47. Example of monolithic IC structure

12. Ceramic Capacitor

When using a ceramic capacitor, determine a capacitance value considering the change of capacitance with temperature and the decrease in nominal capacitance due to DC bias and others.

13. Thermal Shutdown Circuit(TSD)

This IC has a built-in thermal shutdown circuit that prevents heat damage to the IC. Normal operation should always be within the IC's maximum junction temperature rating. If however the rating is exceeded for a continued period, the junction temperature (T_j) will rise which will activate the TSD circuit that will turn OFF power output pins. When the T_j falls below the TSD threshold, the circuits are automatically restored to normal operation.

Note that the TSD circuit operates in a situation that exceeds the absolute maximum ratings and therefore, under no circumstances, should the TSD circuit be used in a set design or for any purpose other than protecting the IC from heat damage.

14. Over Current Protection Circuit (OCP)

This IC incorporates an integrated overcurrent protection circuit that is activated when the load is shorted. This protection circuit is effective in preventing damage due to sudden and unexpected incidents. However, the IC should not be used in applications characterized by continuous operation or transitioning of the protection circuit.

Ordering Information

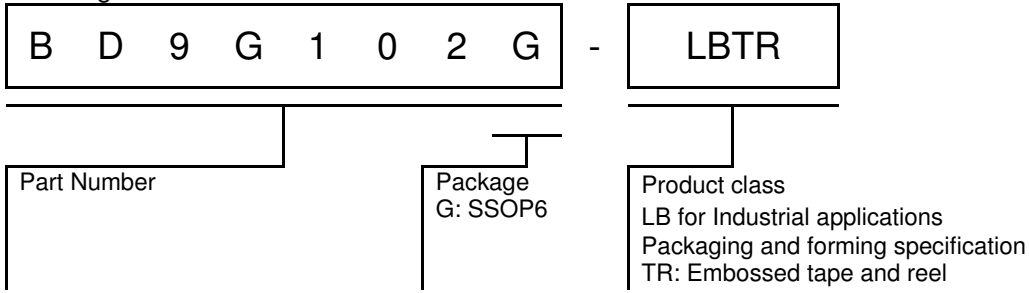

Marking Diagram

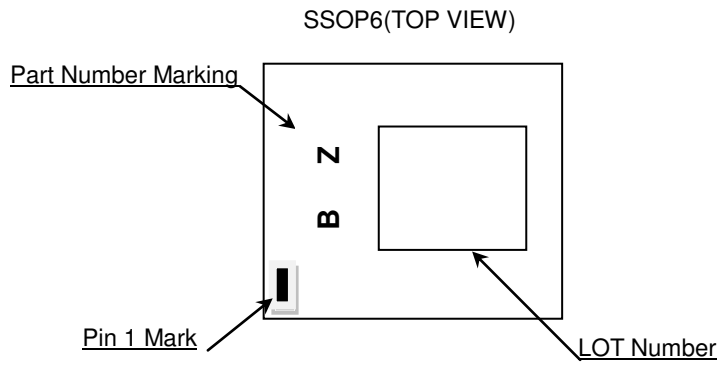
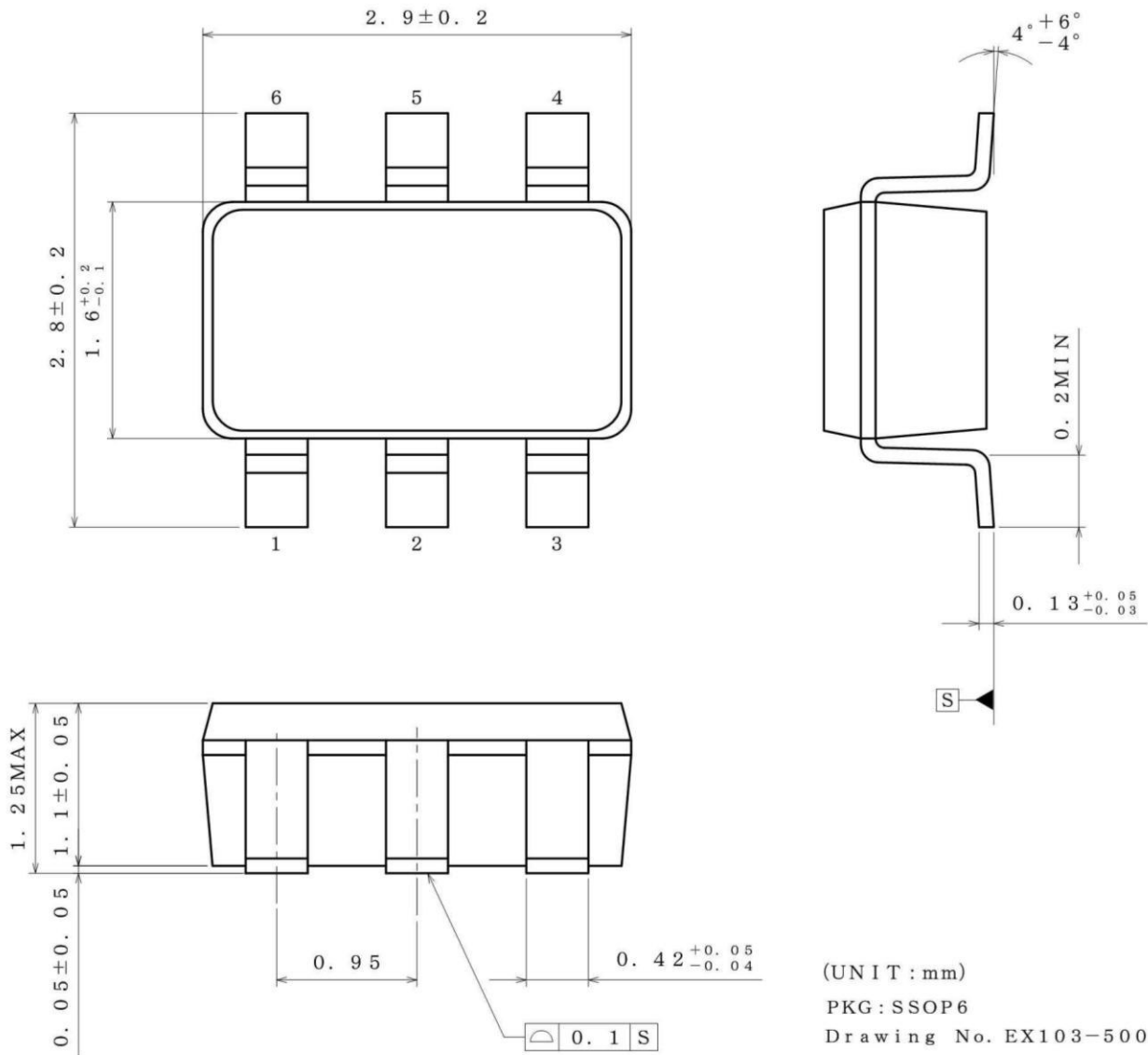

Figure 48. Marking Diagram

Physical Dimension and Packing Information

Package Name	SSOP6
--------------	-------



<Tape and Reel information>

Tape	Embossed carrier tape
Quantity	3000pcs
Direction of feed	TR (The direction is the 1pin of product is at the upper right when you hold reel on the left hand and you pull out the tape on the right hand)

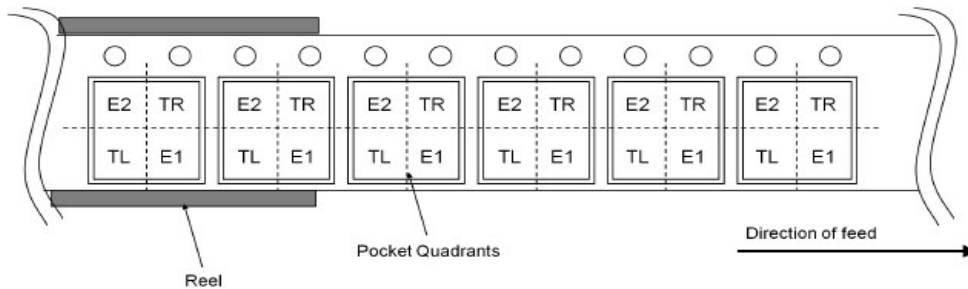

Revision History

Date	Revision	Changes
29.Jun.2017	001	New Release

Notice

Precaution on using ROHM Products

1. If you intend to use our Products in devices requiring extremely high reliability (such as medical equipment ^(Note 1), aircraft/spacecraft, nuclear power controllers, etc.) and whose malfunction or failure may cause loss of human life, bodily injury or serious damage to property ("Specific Applications"), please consult with the ROHM sales representative in advance. Unless otherwise agreed in writing by ROHM in advance, ROHM shall not be in any way responsible or liable for any damages, expenses or losses incurred by you or third parties arising from the use of any ROHM's Products for Specific Applications.

(Note1) Medical Equipment Classification of the Specific Applications

JAPAN	USA	EU	CHINA
CLASS III	CLASS III	CLASS II b	CLASS III
CLASS IV		CLASS III	

2. ROHM designs and manufactures its Products subject to strict quality control system. However, semiconductor products can fail or malfunction at a certain rate. Please be sure to implement, at your own responsibilities, adequate safety measures including but not limited to fail-safe design against the physical injury, damage to any property, which a failure or malfunction of our Products may cause. The following are examples of safety measures:
 - [a] Installation of protection circuits or other protective devices to improve system safety
 - [b] Installation of redundant circuits to reduce the impact of single or multiple circuit failure
3. Our Products are not designed under any special or extraordinary environments or conditions, as exemplified below. Accordingly, ROHM shall not be in any way responsible or liable for any damages, expenses or losses arising from the use of any ROHM's Products under any special or extraordinary environments or conditions. If you intend to use our Products under any special or extraordinary environments or conditions (as exemplified below), your independent verification and confirmation of product performance, reliability, etc. prior to use, must be necessary:
 - [a] Use of our Products in any types of liquid, including water, oils, chemicals, and organic solvents
 - [b] Use of our Products outdoors or in places where the Products are exposed to direct sunlight or dust
 - [c] Use of our Products in places where the Products are exposed to sea wind or corrosive gases, including Cl₂, H₂S, NH₃, SO₂, and NO₂
 - [d] Use of our Products in places where the Products are exposed to static electricity or electromagnetic waves
 - [e] Use of our Products in proximity to heat-producing components, plastic cords, or other flammable items
 - [f] Sealing or coating our Products with resin or other coating materials
 - [g] Use of our Products without cleaning residue of flux (even if you use no-clean type fluxes, cleaning residue of flux is recommended); or Washing our Products by using water or water-soluble cleaning agents for cleaning residue after soldering
 - [h] Use of the Products in places subject to dew condensation
4. The Products are not subject to radiation-proof design.
5. Please verify and confirm characteristics of the final or mounted products in using the Products.
6. In particular, if a transient load (a large amount of load applied in a short period of time, such as pulse. is applied, confirmation of performance characteristics after on-board mounting is strongly recommended. Avoid applying power exceeding normal rated power; exceeding the power rating under steady-state loading condition may negatively affect product performance and reliability.
7. De-rate Power Dissipation depending on ambient temperature. When used in sealed area, confirm that it is the use in the range that does not exceed the maximum junction temperature.
8. Confirm that operation temperature is within the specified range described in the product specification.
9. ROHM shall not be in any way responsible or liable for failure induced under deviant condition from what is defined in this document.

Precaution for Mounting / Circuit board design

1. When a highly active halogenous (chlorine, bromine, etc.) flux is used, the residue of flux may negatively affect product performance and reliability.
2. In principle, the reflow soldering method must be used on a surface-mount products, the flow soldering method must be used on a through hole mount products. If the flow soldering method is preferred on a surface-mount products, please consult with the ROHM representative in advance.

For details, please refer to ROHM Mounting specification

Precautions Regarding Application Examples and External Circuits

1. If change is made to the constant of an external circuit, please allow a sufficient margin considering variations of the characteristics of the Products and external components, including transient characteristics, as well as static characteristics.
2. You agree that application notes, reference designs, and associated data and information contained in this document are presented only as guidance for Products use. Therefore, in case you use such information, you are solely responsible for it and you must exercise your own independent verification and judgment in the use of such information contained in this document. ROHM shall not be in any way responsible or liable for any damages, expenses or losses incurred by you or third parties arising from the use of such information.

Precaution for Electrostatic

This Product is electrostatic sensitive product, which may be damaged due to electrostatic discharge. Please take proper caution in your manufacturing process and storage so that voltage exceeding the Products maximum rating will not be applied to Products. Please take special care under dry condition (e.g. Grounding of human body / equipment / solder iron, isolation from charged objects, setting of Ionizer, friction prevention and temperature / humidity control).

Precaution for Storage / Transportation

1. Product performance and soldered connections may deteriorate if the Products are stored in the places where:
 - [a] the Products are exposed to sea winds or corrosive gases, including Cl₂, H₂S, NH₃, SO₂, and NO₂
 - [b] the temperature or humidity exceeds those recommended by ROHM
 - [c] the Products are exposed to direct sunshine or condensation
 - [d] the Products are exposed to high Electrostatic
2. Even under ROHM recommended storage condition, solderability of products out of recommended storage time period may be degraded. It is strongly recommended to confirm solderability before using Products of which storage time is exceeding the recommended storage time period.
3. Store / transport cartons in the correct direction, which is indicated on a carton with a symbol. Otherwise bent leads may occur due to excessive stress applied when dropping of a carton.
4. Use Products within the specified time after opening a humidity barrier bag. Baking is required before using Products of which storage time is exceeding the recommended storage time period.

Precaution for Product Label

A two-dimensional barcode printed on ROHM Products label is for ROHM's internal use only.

Precaution for Disposition

When disposing Products please dispose them properly using an authorized industry waste company.

Precaution for Foreign Exchange and Foreign Trade act

Since concerned goods might be fallen under listed items of export control prescribed by Foreign exchange and Foreign trade act, please consult with ROHM in case of export.

Precaution Regarding Intellectual Property Rights

1. All information and data including but not limited to application example contained in this document is for reference only. ROHM does not warrant that foregoing information or data will not infringe any intellectual property rights or any other rights of any third party regarding such information or data.
2. ROHM shall not have any obligations where the claims, actions or demands arising from the combination of the Products with other articles such as components, circuits, systems or external equipment (including software).
3. No license, expressly or implied, is granted hereby under any intellectual property rights or other rights of ROHM or any third parties with respect to the Products or the information contained in this document. Provided, however, that ROHM will not assert its intellectual property rights or other rights against you or your customers to the extent necessary to manufacture or sell products containing the Products, subject to the terms and conditions herein.

Other Precaution

1. This document may not be reprinted or reproduced, in whole or in part, without prior written consent of ROHM.
2. The Products may not be disassembled, converted, modified, reproduced or otherwise changed without prior written consent of ROHM.
3. In no event shall you use in any way whatsoever the Products and the related technical information contained in the Products or this document for any military purposes, including but not limited to, the development of mass-destruction weapons.
4. The proper names of companies or products described in this document are trademarks or registered trademarks of ROHM, its affiliated companies or third parties.

General Precaution

1. Before you use our Products, you are requested to carefully read this document and fully understand its contents. ROHM shall not be in any way responsible or liable for failure, malfunction or accident arising from the use of any ROHM's Products against warning, caution or note contained in this document.
2. All information contained in this document is current as of the issuing date and subject to change without any prior notice. Before purchasing or using ROHM's Products, please confirm the latest information with a ROHM sales representative.
3. The information contained in this document is provided on an "as is" basis and ROHM does not warrant that all information contained in this document is accurate and/or error-free. ROHM shall not be in any way responsible or liable for any damages, expenses or losses incurred by you or third parties resulting from inaccuracy or errors of or concerning such information.