

TE RELAYS

Miniature PC Board, Twin Type, 1 Form C Automotive Relay

< Protective construction >

High heat-resistant type: Sealed

Pin in Paste compliant type: Flux tight

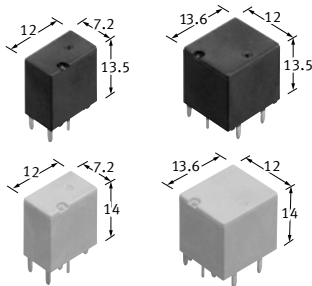

(Unit: mm)

FEATURES

- Compact and high-capacity 25 A load switching
- Pin in Paste compliant model added.

TYPICAL APPLICATIONS

- Powered windows, Automatic door locks, Powered mirrors, Powered sunroof, Powered seats, Lift gates and Slide door closers, etc.

ORDERING INFORMATION (PART NO.)

ACTE

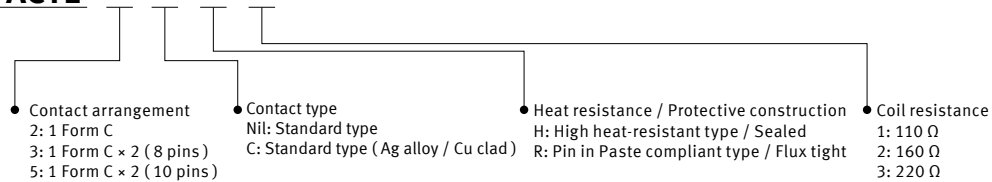

Automotive Relays TE RELAYS

TYPES

Contact arrangement	Contact type	Rated coil voltage	Coil resistance	Part No.		Packing	
				Heat resistance		Carton (1-tube)	Case
				High heat-resistant type	Pin in Paste compliant type		
1 Form C	Standard type	12 V DC	110 Ω	ACTE2H1	ACTE2R1	50 pcs.	2,000 pcs.
			160 Ω	ACTE2H2	ACTE2R2		
			220 Ω	ACTE2H3	ACTE2R3		
	Standard type (Ag alloy / Cu clad)		110 Ω	ACTE2CH1	ACTE2CR1		
			160 Ω	ACTE2CH2	ACTE2CR2		
			220 Ω	ACTE2CH3	ACTE2CR3		
1 Form C x 2 (8 pins)	Standard type		110 Ω	ACTE3H1	ACTE3R1	40 pcs.	
			160 Ω	ACTE3H2	ACTE3R2		
			220 Ω	ACTE3H3	ACTE3R3		
	Standard type (Ag alloy / Cu clad)		110 Ω	ACTE3CH1	ACTE3CR1		
			160 Ω	ACTE3CH2*	ACTE3CR2		
			220 Ω	ACTE3CH3	ACTE3CR3		
1 Form C x 2 (10 pins)	Standard type	110 Ω	ACTE5H1	ACTE5R1	40 pcs.		
		160 Ω	ACTE5H2	ACTE5R2			
		220 Ω	ACTE5H3	ACTE5R3			
	Standard type (Ag alloy / Cu clad)	110 Ω	ACTE5CH1	ACTE5CR1			
		160 Ω	ACTE5CH2	ACTE5CR2			
		220 Ω	ACTE5CH3	ACTE5CR3			

* Please order "ACTE3CH2A05V" (standard stock part number).
The letter of suffix "V" is not marked on the device (relay). It is only marked on the inner and outer carton.

RATING

Coil data

Rated coil voltage	Operate (Set) voltage (at 20°C)(Initial)	Release (Reset) voltage (at 20°C)(Initial)	Rated operating current [±10%] (at 20°C)	Coil resistance [±10%] (at 20°C)	Rated operating power (at 20°C)	Usable voltage range
12 V DC	Max. 5.5 V DC	Min. 0.6 V DC	109 mA	110 Ω	1,309 mW	10 to 16 V DC
	Max. 6.5 V DC		75 mA	160 Ω	900 mW	
	Max. 7.7 V DC	Min. 0.8 V DC	54.5 mA	220 Ω	655 mW	

Specifications

Item		Specifications
Contact data	Contact arrangement	1 Form C, 1 Form C x 2
	Contact resistance (initial)	Max. 50 mΩ (N.O. side: typ. 4 mΩ, N.C. side: typ. 5 mΩ) (by voltage drop 1 A 6 V DC)
	Contact material	Ag alloy
	Rated switching capacity (resistive)	N.O. side: 20 A 14 V DC, N.C. side: 10 A 14 V DC
	Max. carrying current (initial)*1	25 A/2 min (coil applied voltage 12 V DC, at 20°C)
	Min. switching load (resistive)*2	1 A 14 V DC (at 20°C)
Insulated resistance (initial)		Min. 100 MΩ (at 500 V DC, Measurement at same location as "Dielectric strength" section)
Dielectric strength (initial)	Between open contacts	500 Vrms for 1 min. (detection current: 10 mA)
	Between contacts and coil	500 Vrms for 1 min. (detection current: 10 mA)
Time characteristics (initial)	Operate (Set) time (at rated voltage)	Max. 10 ms (at 20°C, without contact bounce time)
	Release (Reset) time (at rated voltage)	Max. 10 ms (at 20°C, without contact bounce time) (without diode)
Shock resistance	Functional	Min. 100 m/s ² (approx. 10 G) (half-wave pulse of sine wave: 11 ms, detection time: 10 μs)
	Destructive	Min. 1,000 m/s ² (approx. 100 G) (half-wave pulse of sine wave: 6 ms)
Vibration resistance	Functional	10 to 100 Hz, Min. 44.1 m/s ² (approx. 4.5 G) (detection time: 10 μs)
	Destructive	10 to 500 Hz, Min. 44.1 m/s ² (approx. 4.5 G) Time of vibration for each direction; X, Y direction: 2 hours, Z direction: 4 hours
Expected life	Mechanical	Min. 10 ⁷ (at 120 times/min)
	Electrical*4	<Resistive load> Min. 10 ⁵ at rated switching capacity operating frequency: ON 1s, OFF 9s <Motor load> Min. 10 ⁵ at 25 A 14 V DC at motor lock operating frequency: ON 0.5s, OFF 9.5s
Conditions	Conditions for usage, transport and storage*3	High heat-resistant type/Pin in Paste compliant type Ambient temperature: -40 to +110°C Humidity: 2 to 85% RH (Avoid icing and condensation)
Unit weight		Single type: approx. 3.5 g, Twin type: approx. 6.5 g

Notes: *1. Depends on connection conditions. Also, this does not guarantee repeated switching. We recommend that you confirm operation under actual conditions.
 *2. This value can change due to the switching frequency, environmental conditions, and desired reliability level, therefore it is recommended to check this with the actual load.
 *3. The upper operation ambient temperature limit is the maximum temperature that can satisfy the coil temperature rise value. For details, please refer to the "Automotive Relay Users Guide".
 Please inquire our sales representative if you will be using the relay in a high temperature atmosphere (110°C).
 *4. Do not use for lamp loads, electric discharge lamp loads, any other lamp loads and capacitor loads. Please inquire our sales representative for details.

*If the relay is used continuously for long periods of time with coils on both sides in an energized condition, breakdown might occur due to abnormal heating depending on the carrying condition. Therefore, please inquire our sales representative when using with a circuit that causes an energized condition on both sides simultaneously.

REFERENCE DATA

1.-(1)Coil temperature rise (at room temperature)

Sample: ACTE3H2, 3 pcs.
 Carrying current: 0 A, 10 A, 20 A
 Ambient temperature: Room temperature

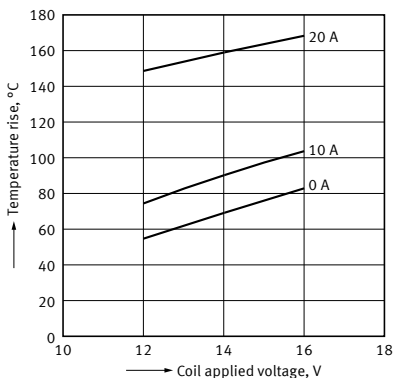

1.-(2)Coil temperature rise (at 110°C)

Sample: ACTE3H2, 3 pcs.
 Carrying current: 0 A, 10 A, 20 A
 Ambient temperature: 110°C

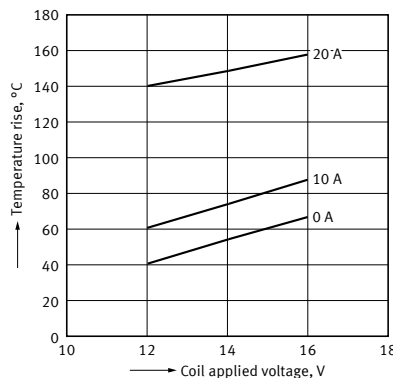

2. Ambient temperature and usable voltage range

Sample: ACTE3H2

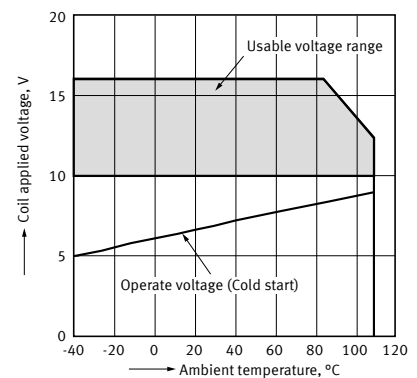

Automotive Relays TE RELAYS

3. Distribution of operate (set) and release (reset) voltage

Sample: ACTE3H2, 40 × 2 pcs.

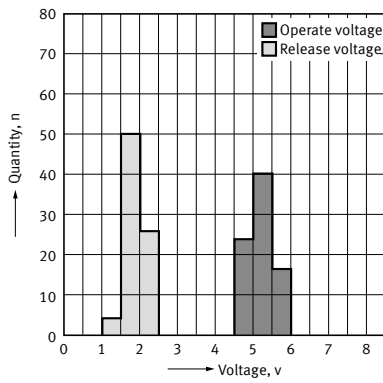

4. Distribution of operate (set) and release (reset) time

Sample: ACTE3H2, 40 × 2 pcs.

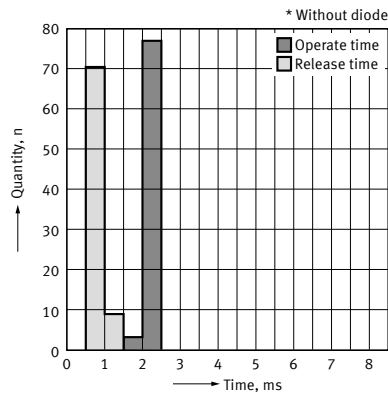

5. Electrical life test (Motor lock)

Sample: ACTE3H2, 3 pcs.
 Load: 25 A 14 V DC
 Power window motor actual load (lock condition)
 Operating frequency: ON 0.5 s, OFF 9.5 s
 Ambient temperature: Room temperature
 Circuit:

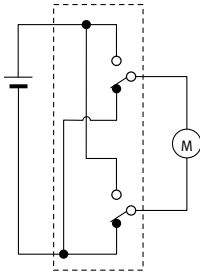

Change of operate (set) and release (reset) voltage

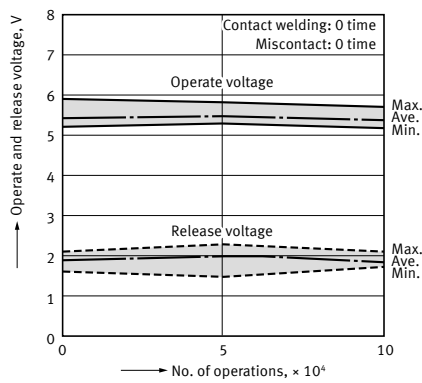

Change of contact resistance

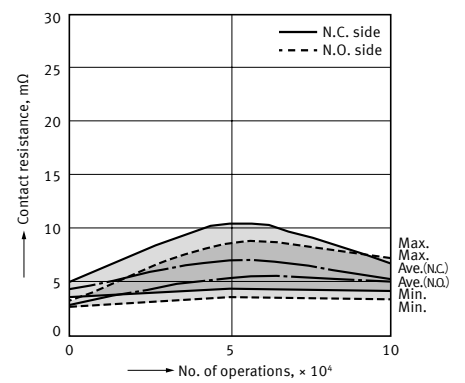

Load current waveform

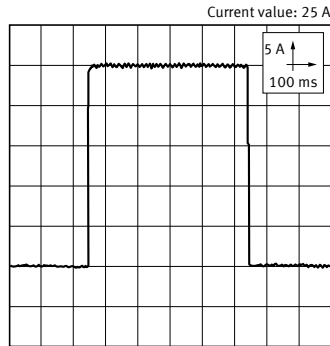

DIMENSIONS

CAD The CAD data of the products with a "CAD" mark can be downloaded from our Website.

Unit: mm

1 Form C type

CAD



External dimensions

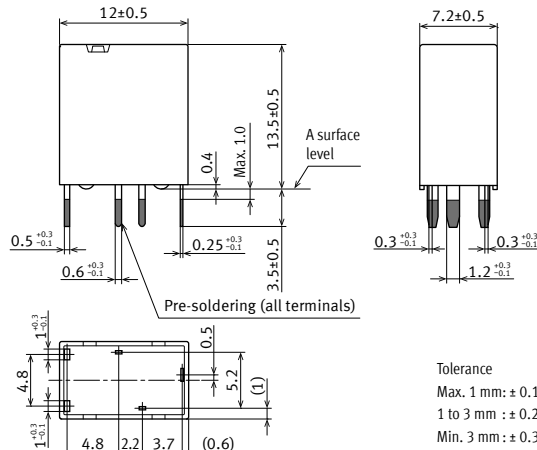

PC board pattern (BOTTOM VIEW)

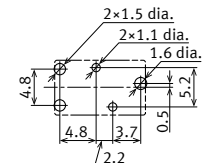

Tolerance: ± 0.1

Schematic (BOTTOM VIEW)

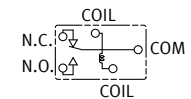

Tolerance
Max. 1 mm: ± 0.1
1 to 3 mm: ± 0.2
Min. 3 mm: ± 0.3

* Dimensions (thickness and width) of terminal is measured after pre-soldering. Intervals between terminals is measured at A surface level.

Twin type (8 pins)

CAD



External dimensions

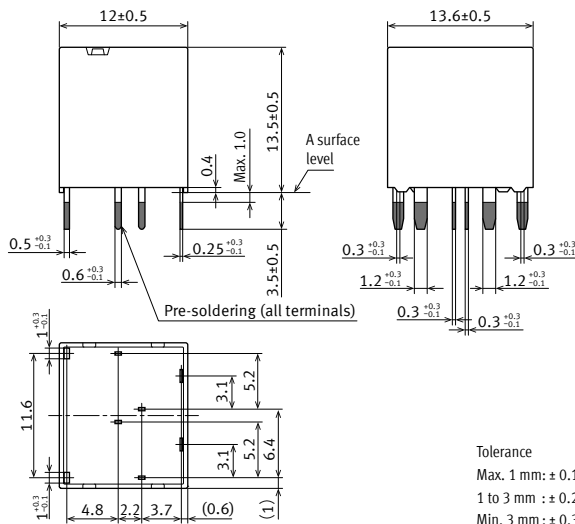

PC board pattern (BOTTOM VIEW)

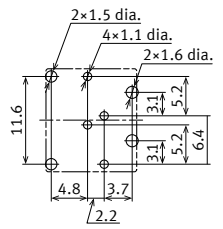

Tolerance: ± 0.1

Schematic (BOTTOM VIEW)

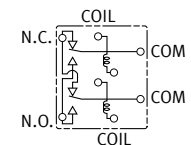

Tolerance
Max. 1 mm: ± 0.1
1 to 3 mm: ± 0.2
Min. 3 mm: ± 0.3

* Dimensions (thickness and width) of terminal is measured after pre-soldering. Intervals between terminals is measured at A surface level.

Automotive Relays TE RELAYS

■ Twin type (10 pins)

CAD



External dimensions

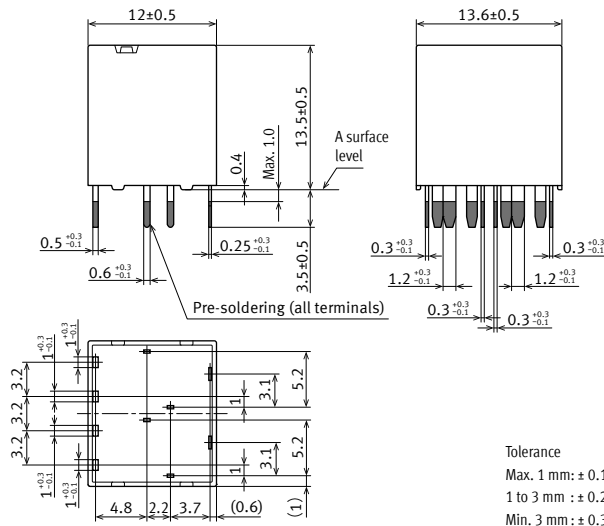

PC board pattern (BOTTOM VIEW)

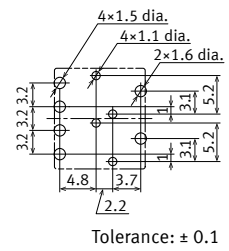

Schematic (BOTTOM VIEW)

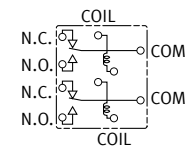

* Dimensions (thickness and width) of terminal is measured after pre-soldering.
Intervals between terminals is measured at A surface level.

■ 1 Form C type

Pin in Paste compliant type

CAD



External dimensions

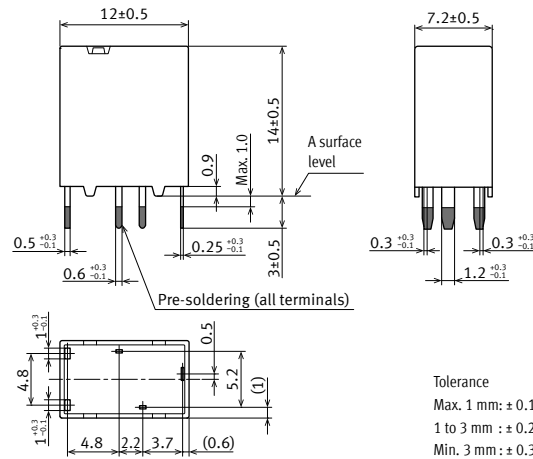

PC board pattern (BOTTOM VIEW)

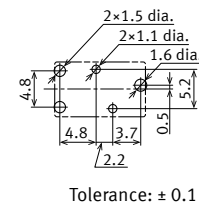

Schematic (BOTTOM VIEW)

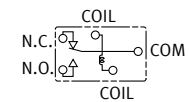

* Dimensions (thickness and width) of terminal is measured after pre-soldering.
Intervals between terminals is measured at A surface level.

■ Twin type (8 pins)

Pin in Paste compliant type

CAD

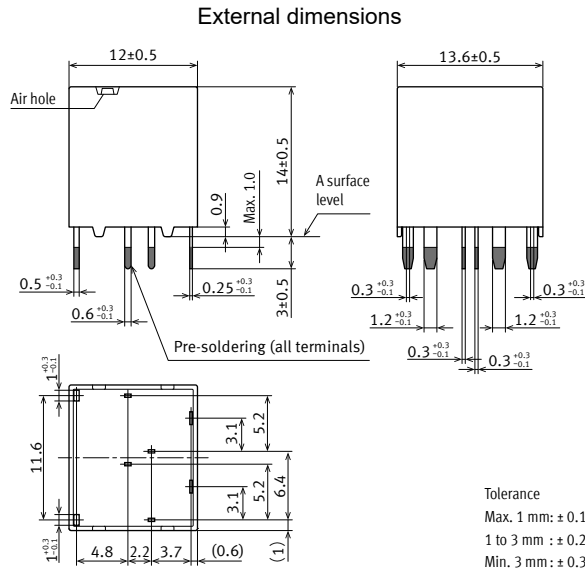

* Dimensions (thickness and width) of terminal is measured after pre-soldering.
 Intervals between terminals is measured at A surface level.

PC board pattern (BOTTOM VIEW)

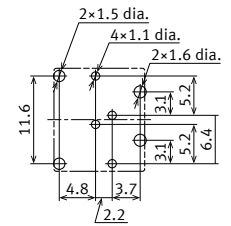

Tolerance: ± 0.1

Schematic (BOTTOM VIEW)

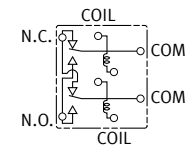

■ Twin type (10 pins)

Pin in Paste compliant type

CAD

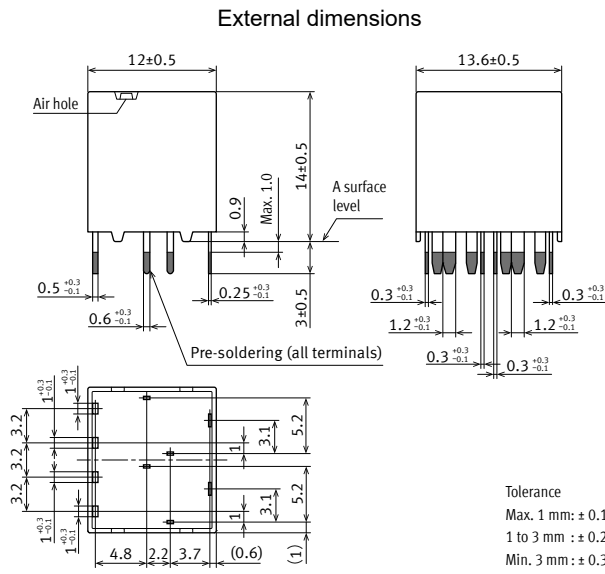

* Dimensions (thickness and width) of terminal is measured after pre-soldering.
 Intervals between terminals is measured at A surface level.

PC board pattern (BOTTOM VIEW)

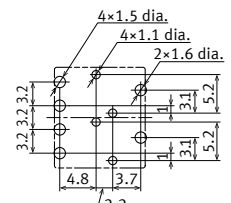

Tolerance: ± 0.1

Schematic (BOTTOM VIEW)

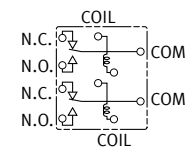

GUIDELINES FOR USAGE

■ For general cautions for use, please refer to the "Automotive Relay Users Guide".

■ Atmosphere when using, storing and transporting

1) Ambient temperature, humidity and air pressure during usage, transport, and storage of the relay.

(1) Temperature: -40 to +110°C

(High heat resistant type/Pin in Paste compliant type)

(2) Humidity: 2 to 85% RH (Avoid icing and condensation)

(3) Air pressure: 86 to 106 kPa

The humidity range varies with the temperature. Use within the range indicated in the graph below.

[Temperature and humidity range for usage, transport, and storage]

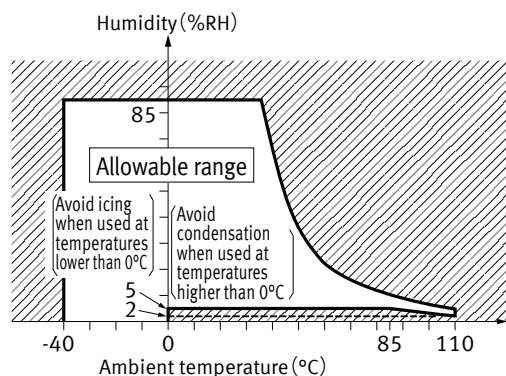

2) Water condensation

Water condensation occurs when the ambient temperature drops suddenly from a high temperature and humidity, or, the relay is suddenly transferred from a low ambient temperature to a high temperature and humidity. Condensation causes the failures like insulation deterioration, wire disconnection and rust etc. Panasonic Corporation does not guarantee the failures caused by condensation. The heat conduction by the equipment may accelerate the cooling of relay itself, and the condensation may occur. Please confirm no condensation in the worst condition of the actual usage. (Special attention should be paid when high temperature heating parts are close to the relay. Also, please consider the condensation may occur inside of the relay.)

3) Icing

Please check the icing when an ambient temperature is lower than 0°C. Icing means, the moisture contained in the surrounding environment and inside the relay freezes when the ambient temperature falls below the freezing point. The icing causes the sticking of movable portion, the operation delay and the contact conduction failure etc. Panasonic Corporation does not guarantee the failures caused by the icing. The heat conduction by the equipment may accelerate the cooling of relay itself and the icing may occur. Icing condition is changed by ambient environment, please make sure to confirm no icing in the worst condition of the actual usage.

■ Mounting and cleaning conditions for Pin in Paste compliant type

When soldering this relay, please observe the following conditions.

[I.R.S method (recommended)]

(Recommended number of reflow: 1 time)

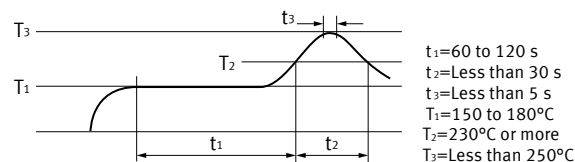

1) Cautions for mounting

- (1) The temperature profile shows the temperature at the soldering portion on the PC board surface.
- (2) Depending on the mounting density condition, reflow heating method, and PC board type (metal etc.), the relay's exterior and interior temperature may become extremely high. Therefore, please confirm well under the actual use condition before use.

2) The other cautions of reflow soldering

- (1) When soldering condition is out of recommendation, the relay performance may be adversely affected. If soldering conditions are out of our recommendation, please inquire our sales representative before operation.
- (2) Please check the effect at the actual soldering because heat stress to relay is changed by PC board type and manufacturing process condition
- (3) Solder creepage, wettability or soldering strength will be affected by the mounting condition or soldering material. Please check the actual production condition in detail.
- (4) Do not wash the relay as failures may occur.
- (5) This product is not plastic sealed type. Please perform coating with sufficient attention to avoid infiltration of the solvent to the inside. Also, please pay careful attention to use and store them with no contamination of foreign material.

Please refer to "**the latest product specifications**" when designing your product.
 •Requests to customers:
<https://industrial.panasonic.com/ac/e/salespolicies/>

Please contact

Panasonic Corporation

Electromechanical Control Business Division

■1006, Oaza Kadoma, Kadoma-shi, Osaka 571-8506, Japan
industrial.panasonic.com/ac/e/

Panasonic[®]

©Panasonic Corporation 2021