

AC / DC Filter, High Symmetrical Attenuation

new



See below:
[Approvals and Compliances](#)

Description

- Filter for 277 VAC or 400 VDC applications
- 1-stage
- Compact filter with high symmetrical attenuation

Unique Selling Proposition

- For high AC- or DC-voltages
- Excellent symmetrical attenuation
- Completely enclosed steel housing
- Optional overvoltage protection

Characteristics

- For 277 VAC applications in North America WYE 480/277 volt system
- For 400 VDC applications e.g. data center
- Especially designed for applications with symmetrical noise caused by switching semiconductors
- Suitable for use in equipment according to IEC/UL 62368-1
- Suitable for use in medical equipment according to IEC/UL 60601-1 (1 MOOP, 1 MOPP)

Other versions on request

- Version with varistor for overvoltage protection

Weblinks

[pdf data sheet](#), [html datasheet](#), [General Product Information](#), [Approvals](#), [Distributor-Stock-Check](#), [Detailed request for product](#), [Landing Page](#)

Technical Data

Ratings IEC	1 - 20A @ Ta 40 °C / 277 VAC; 50Hz 1 - 20 A @ Tu 40 °C / 277 VDC
Ratings UL/CSA	1 - 20A @ Ta 40 °C / 277 VAC; 60Hz 1 - 20 A @ Tu 40 °C / 400 VDC
Leakage Current	industrial < 1mA (250V / 60Hz)
Dielectric Strength	> 1.7 kVDC between L-N > 2.7 kVDC between L/N-PE Test voltage (2 sec)
Allowable Operation Temperature	-40 °C to 100 °C
Climatic Category	40/100/21 acc. to IEC 60068-1
Protection Class	Suitable for appliances with protection class I acc. to IEC 61140
Terminal	Quick connect terminal 6.3 x 0.8 mm
Material: Housing	Metal

Line Filter	Standard, medical and industrial version, IEC 60939, UL 1283, CSA C22.2 no. 8 Technical Details
MTBF	> 200'000h acc. to MIL-HB-217 F

Approvals and Compliances

Detailed information on product approvals, code requirements, usage instructions and detailed test conditions can be looked up in [Details about Approvals](#)

SCHURTER products are designed for use in industrial environments. They have approvals from independent testing bodies according to national and international standards. Products with specific characteristics and requirements such as required in the automotive sector according to IATF 16949, medical technology according to ISO 13485 or in the aerospace industry can be offered exclusively with customer-specific, individual agreements by SCHURTER.

Approvals





The approval mark is used by the testing authorities to certify compliance with the safety requirements placed on electronic products.

Approval Reference Type: FMAB HV

Approval Logo	Certificates	Certification Body	Description
	VDE Approvals	VDE	Certificate Number: 40050001
	UL Approvals	UL	UL File Number: E495089

Product standards

Product standards that are referenced

Organization	Design	Standard	Description
	Designed according to	IEC 60939	Passive filters for suppressing electromagnetic interference
	Designed according to	IEC 61058-1	Switches for appliances. Part 1. General requirements
	Designed according to	UL 1283	Electromagnetic interference filters
	Designed according to	CSA C22.2 no. 8	Electromagnetic interference (EMI) filters





Application standards

Application standards where the product can be used

Organization	Design	Standard	Description
	Designed for applications acc.	IEC/UL 62368-1	Audio/video, information and communication technology equipment - Part 1: Safety requirements

Compliances

The product complies with following Guide Lines

Identification	Details	Initiator	Description
	CE declaration of conformity	SCHURTER AG	The CE marking declares that the product complies with the applicable requirements laid down in the harmonisation of Community legislation on its affixing in accordance with EU Regulation 765/2008.
	UKCA declaration of conformity	SCHURTER AG	The UKCA marking declares that the product complies with the applicable requirements laid down in the British Amendment of Regulation (EC) 765/2008.
	RoHS	SCHURTER AG	Directive RoHS 2011/65/EU, Amendment (EU) 2015/863
	China RoHS	SCHURTER AG	The law SJ / T 11363-2006 (China RoHS) has been in force since 1 March 2007. It is similar to the EU directive RoHS.
	REACH	SCHURTER AG	On 1 June 2007, Regulation (EC) No 1907/2006 on the Registration, Evaluation, Authorization and Restriction of Chemicals 1 (abbreviated as "REACH") entered into force.

Dimension [mm]

Case PG

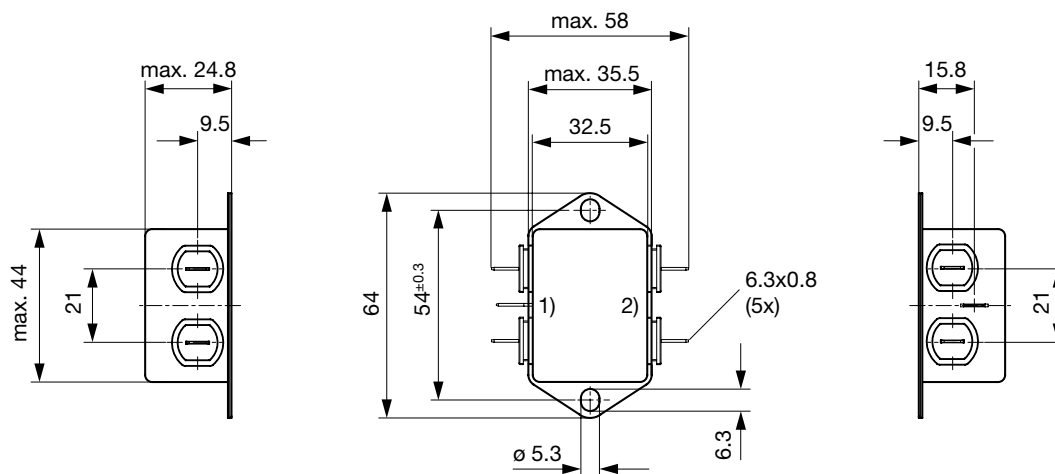

1) Line, 2) Load

Case PH

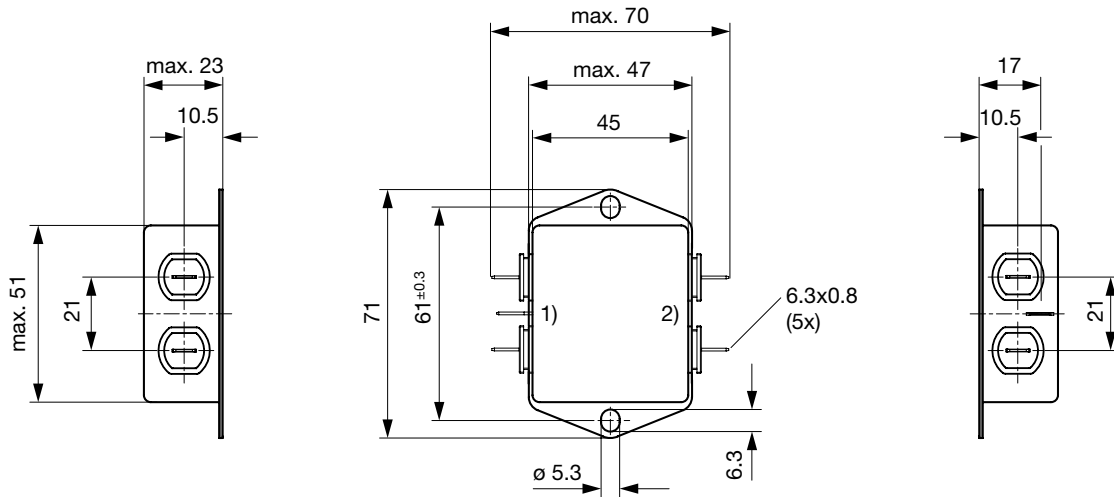

1) Line, 2) Load

Case PI

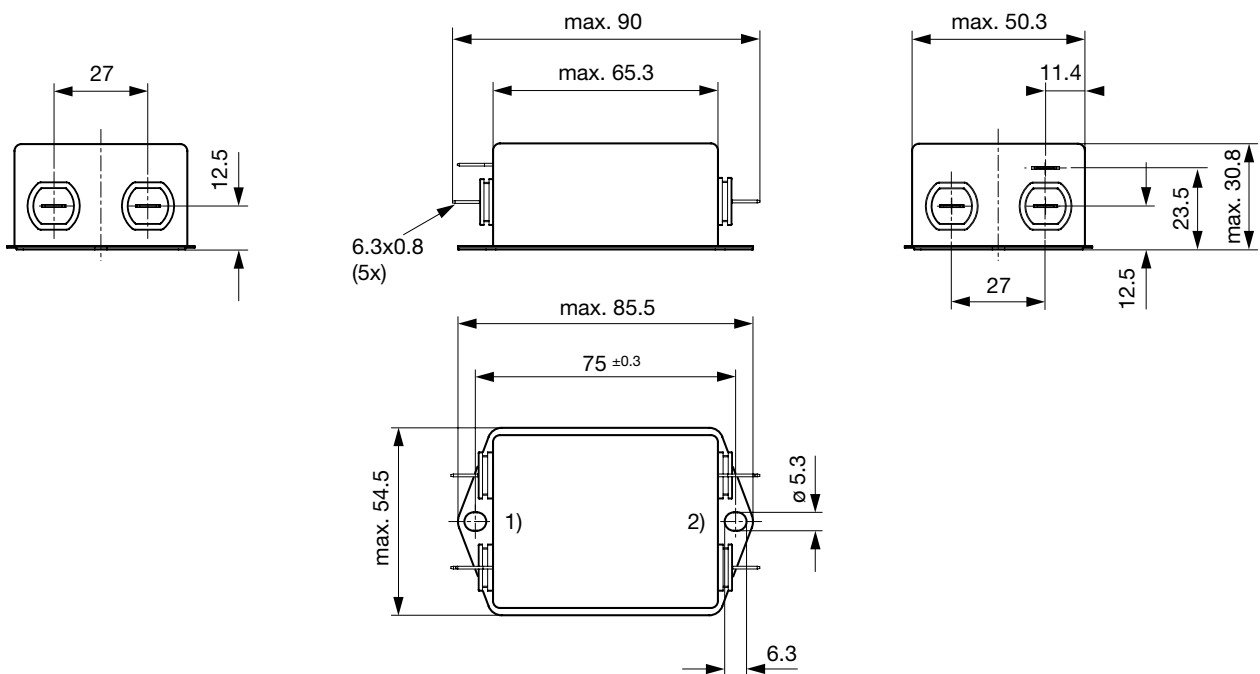

1) Line, 2) Load

Case PK

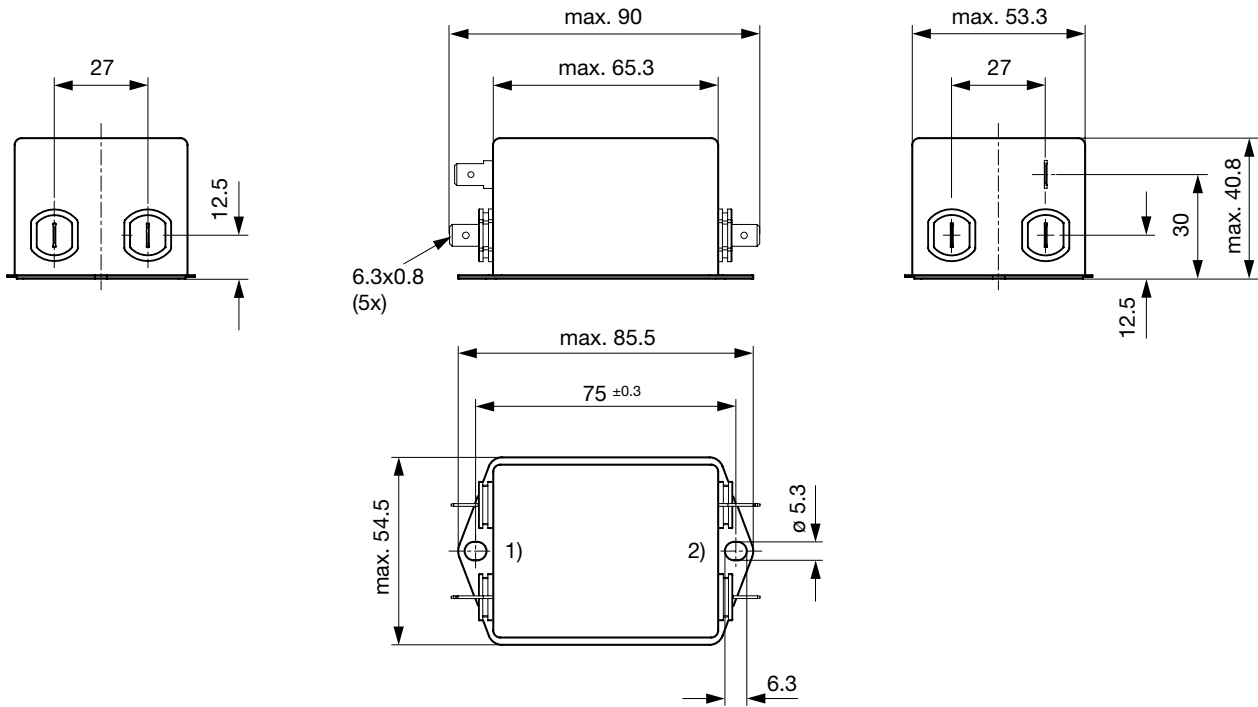

1) Line, 2) Load

Diagrams

Standard Version or medical M80

Medical Version (M5)

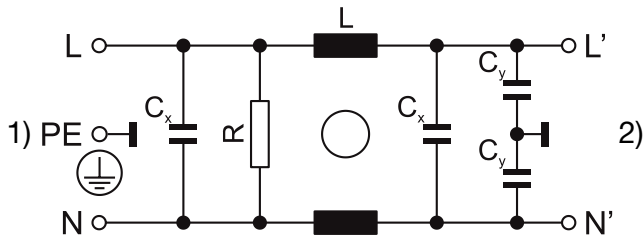

1) Line
 2) Load

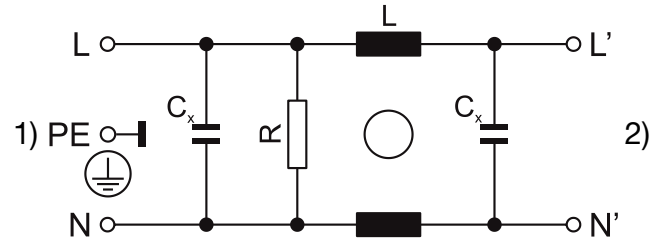

1) Line
 2) Load

Attenuation Loss . . . 0.1/100Ω differential mode 100/0.1Ω differential mode - - - 50Ω differential mode ____ 50Ω common mode
 Standard version

1 A

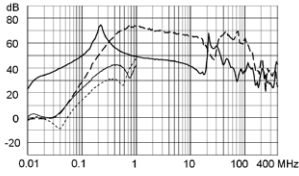

3 A

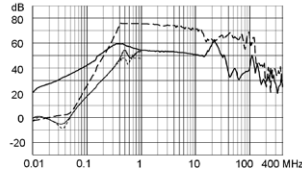

4 A

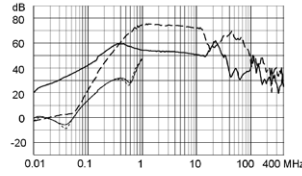

6 A

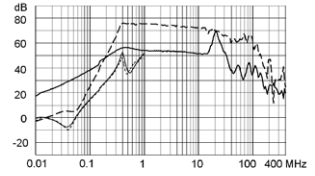

8 A

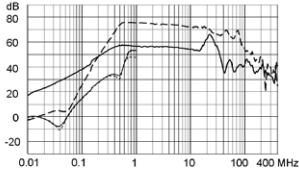

10 A

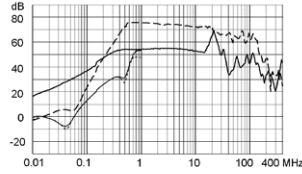

12 A

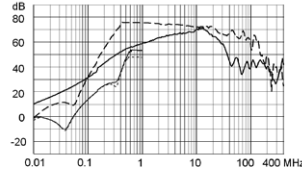

16 A

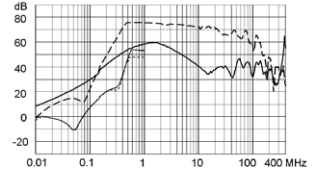

20 A

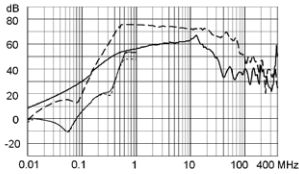

Medical version (M5)

1 A

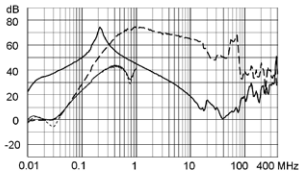

3 A

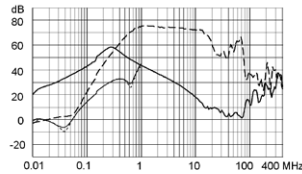

4 A

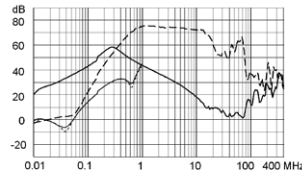

6 A

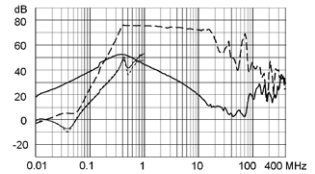

8 A

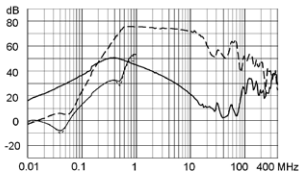

All Variants

Rated current	Filter-Type	Terminal	Lea- leage	Ri	Power Loss	Weight	Housing	Packa- ging	Order Number	
[A]			[mA]	[mΩ]	[W]	[g]		[ST]		
1	Standard version	Quick connect terminal 6.3 x 0.8 mm	0.5	560	1	72 g	PG	20	3-109-227	■
3	Standard version	Quick connect terminal 6.3 x 0.8 mm	0.5	83	1.5	104 g	PH	15	3-109-228	■
4	Standard version	Quick connect terminal 6.3 x 0.8 mm	0.5	53	1.7	108 g	PH	15	3-109-229	■
6	Standard version	Quick connect terminal 6.3 x 0.8 mm	0.5	32.5	2.4	109 g	PH	15	3-109-230	■
8	Standard version	Quick connect terminal 6.3 x 0.8 mm	0.5	29.2	3.8	190 g	PI	10	3-109-231	■
10	Industrial version	Quick connect terminal 6.3 x 0.8 mm	1	22.8	4.6	200 g	PI	10	3-109-232	■

Rated current	Filter-Type	Terminal	Leakage	Ri	Power Loss	Weight	Housing	Packaging	Order Number	
[A]			[mA]	[mΩ]	[W]	[g]		[ST]		
12	Industrial version	Quick connect terminal 6.3 x 0.8 mm	1	13.2	3.8	201 g	PI	10	3-109-233	■
16	Industrial version	Quick connect terminal 6.3 x 0.8 mm	1	7.2	3.7	308 g	PK	10	3-109-234	■
20	Industrial version	Quick connect terminal 6.3 x 0.8 mm	1	8	4.8	322 g	PK	10	3-109-235	■
1	Medical (M5)	Quick connect terminal 6.3 x 0.8 mm	0.005	560	1	72 g	PG	20	3-109-236	
3	Medical (M5)	Quick connect terminal 6.3 x 0.8 mm	0.005	83	1.5	104 g	PH	15	3-109-237	
4	Medical (M5)	Quick connect terminal 6.3 x 0.8 mm	0.005	53	1.7	108 g	PH	15	3-109-238	
6	Medical (M5)	Quick connect terminal 6.3 x 0.8 mm	0.005	32.5	2.4	109 g	PH	15	3-109-239	
8	Medical (M5)	Quick connect terminal 6.3 x 0.8 mm	0.005	29.2	3.8	190 g	PI	10	3-109-240	
10	Medical (M5)	Quick connect terminal 6.3 x 0.8 mm	0.005	22.8	4.6	200 g	PI	10	3-109-241	
12	Medical (M5)	Quick connect terminal 6.3 x 0.8 mm	0.005	13.2	3.8	201 g	PI	10	3-109-242	
16	Medical (M5)	Quick connect terminal 6.3 x 0.8 mm	0.005	7.2	3.7	308 g	PK	10	3-109-243	
20	Medical (M5)	Quick connect terminal 6.3 x 0.8 mm	0.005	8	4.8	322 g	PK	10	3-109-244	
1	Medical (M80)	Quick connect terminal 6.3 x 0.8 mm	0.08	560	1	72 g	PG	20	3-109-426	
3	Medical (M80)	Quick connect terminal 6.3 x 0.8 mm	0.08	83	1.5	104 g	PH	15	3-109-427	
4	Medical (M80)	Quick connect terminal 6.3 x 0.8 mm	0.08	53	1.7	108 g	PH	15	3-109-428	
6	Medical (M80)	Quick connect terminal 6.3 x 0.8 mm	0.08	32.5	2.4	109 g	PH	15	3-109-429	
8	Medical (M80)	Quick connect terminal 6.3 x 0.8 mm	0.08	29.2	3.8	190 g	PI	10	3-109-430	
10	Medical (M80)	Quick connect terminal 6.3 x 0.8 mm	0.08	22.8	4.6	200 g	PI	10	3-109-431	
12	Medical (M80)	Quick connect terminal 6.3 x 0.8 mm	0.08	13.2	3.8	201 g	PI	10	3-109-432	
16	Medical (M80)	Quick connect terminal 6.3 x 0.8 mm	0.08	7.2	3.7	308 g	PK	10	3-109-433	
20	Medical (M80)	Quick connect terminal 6.3 x 0.8 mm	0.08	8	4.8	322 g	PK	10	3-109-434	

■ Most Popular.

Availability for all products can be searched real-time: <https://www.schurter.com/en/Stock-Check/Stock-Check-SCHURTER>