

Dial Setting/Deviation Setting Type

Analog and Non-indicating type, Set temperature by dial

■ Features

- Non-indicating type
- Setting temperature by Dial
- Includes burn out function
- Universal power : TOS



⚠ Please read "Caution for your safety" in operation manual before using.

Autonics
(TOS Series only)

■ Ordering information

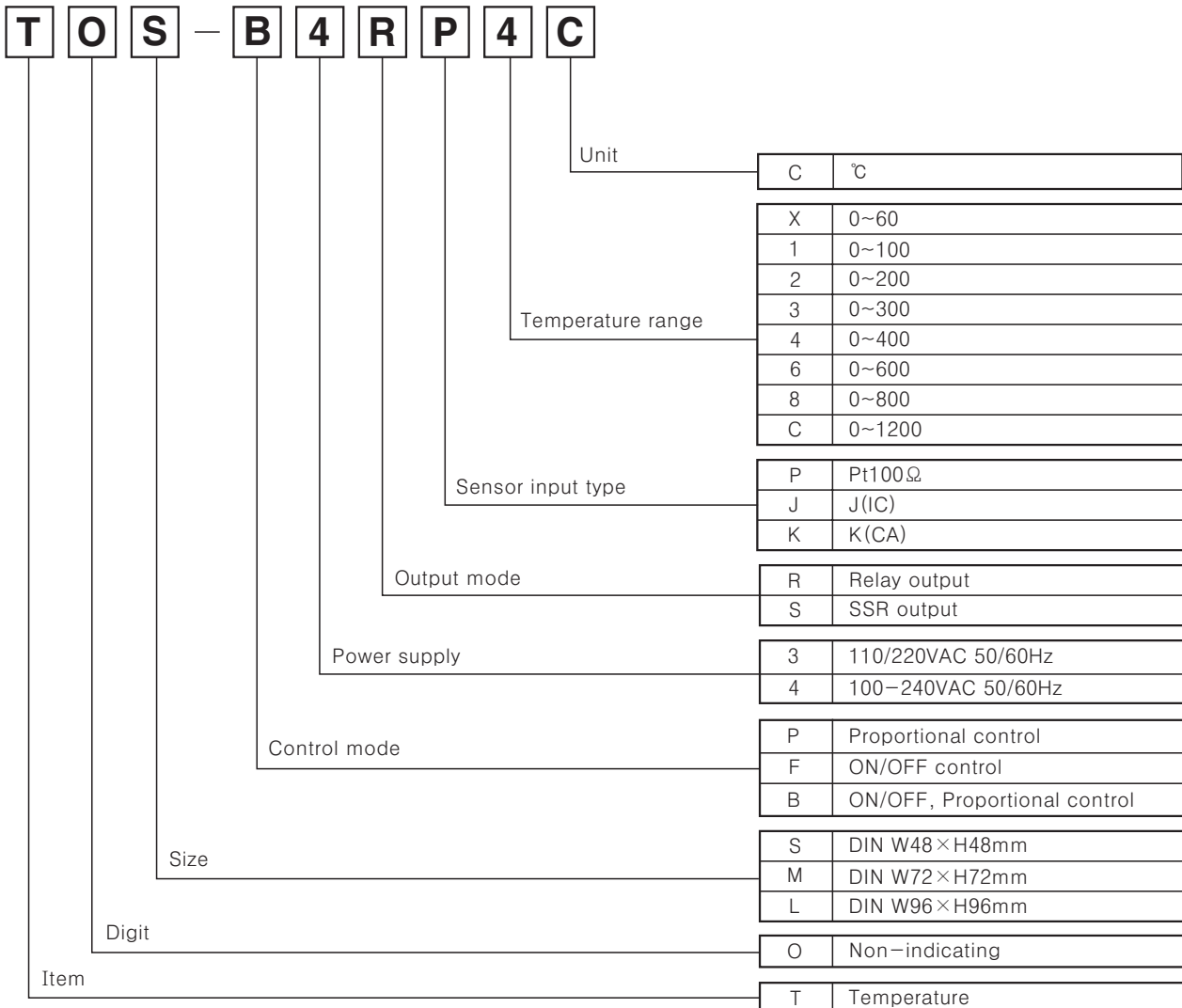

※ See C-43 about sensor temperature range for selection.

(A) Counter

(B) Timer

(C) Temp. controller

(D) Power controller

(E) Panel meter

(F) Tacho/Speed/Pulse meter

(G) Display unit

(H) Sensor controller

(I) Switching power supply

(J) Proximity sensor

(K) Photo electric sensor

(L) Pressure sensor

(M) Rotary encoder

(N) Stepping motor & Driver & Controller

(O) Graphic panel

(P) Production stoppage models & replacement

TOS/TOM/TOL

Temperature range for each sensor

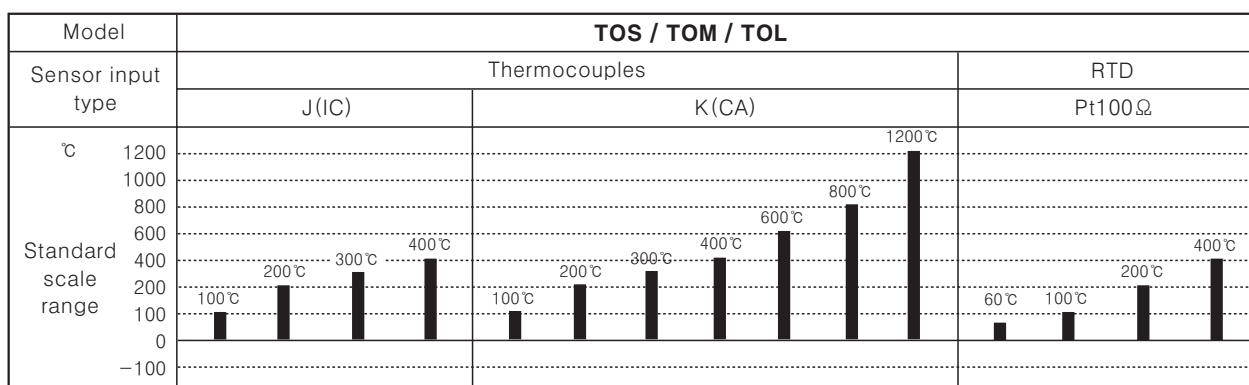

※In case, the sensor is R(PR) type, it is not available to indicate the temperature and control correctly.

Specifications

Model		TOS	TOM	TOL
Power supply		100-240VAC 50/60Hz	110/220VAC 50/60Hz	
Allowable voltage range		90 ~ 110% of rated voltage		
Power consumption		2.2VA	3VA	
Display method		LED ON indicator	LED ON/OFF indicator	
Setting type		Dial setting		
Setting accuracy		F · S ±2%		
Sensor input		Thermocouples : K(CA), J(IC) / RTD : Pt100Ω		
Input line resistance		Thermocouples : Max. 100Ω, RTD : Max. 5Ω per a wire		
Control	ON/OFF	Hysteresis : F · S 0.5 ±0.2% fixed		
	Proportional	Proportional band : F · S 3% fixed, Period : 20sec. fixed		
Control output		<ul style="list-style-type: none"> Relay output : 250VAC 2A 1c SSR Output : 12VDC ±3V Load 20mA Max. 	<ul style="list-style-type: none"> Relay contact output : 250VAC 3A 1c SSR Output : 12VDC ±3V 20mA max. 	
Self-diagnosis		Includes burn out function		
Insulation resistance		Min. 100MΩ (at 500VDC mega)		
Dielectric strength		2000VAC 50/60Hz for 1 minute		
Noise strength		±1kV the square wave noise (pulse width:1μs) by the noise simulator		
Vibration	Mechanical	0.75mm amplitude at frequency of 10 ~ 55Hz in each of X, Y, Z directions for 1 hour		
	Malfunction	0.5mm amplitude at frequency of 10 ~ 55Hz in each of X, Y, Z directions for 10 minutes		
Shock	Mechanical	300m/s ² (Approx. 30G) 3 times at X, Y, Z direction		
	Malfunction	100m/s ² (Approx. 10G) 3 times at X, Y, Z direction		
Relay life cycle	Mechanical	Min. 10,000,000 times		
	Electrical	Min. 100,000 times (250VAC 3A at resistive load)		
Ambient temperature		-10 ~ +50°C (at non-freezing status)		
Storage temperature		-20 ~ +60°C (at non-freezing status)		
Ambient humidity		35 ~ 85%RH		
Approval			_____	_____
Unit weight		Approx. 104g	Approx. 419g	Approx. 426g

※F.S is same with sensor measuring temperature range.

Ex) In case of using temperature is from 0~800°C, Full scale is "800".

Dial Setting/Deviation Setting Type

Connections

※RTD(Resistance Temperature Detector) : Pt 100Ω(3-wire type) ※ Thermocouple : K, J, R

(A) Counter

(B) Timer

(C) Temp. controller

(D) Power controller

(E) Panel meter

(F) Tacho/ Speed/ Pulse meter

(G) Display unit

(H) Sensor controller

(I) Switching power supply

(J) Proximity sensor

(K) Photo electric sensor

(L) Pressure sensor

(M) Rotary encoder

(N) Stepping motor & Driver & Controller

(O) Graphic panel

(P) Production stoppage models & replacement

•TOS

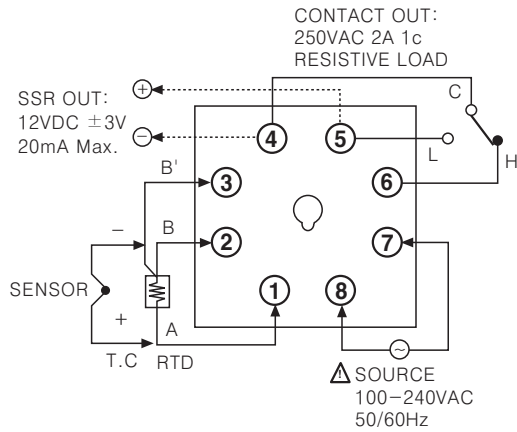

•TOM

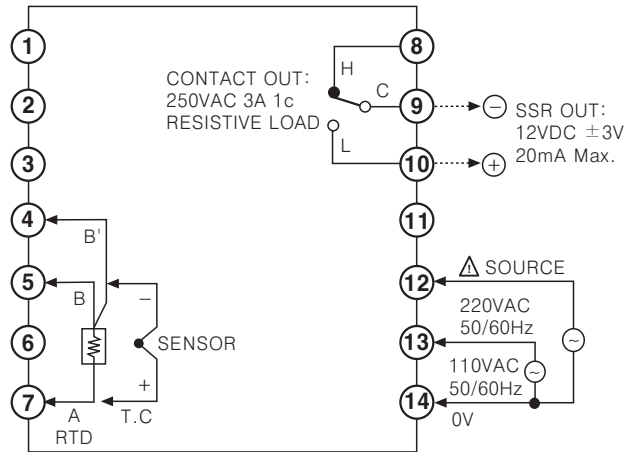

•TOL

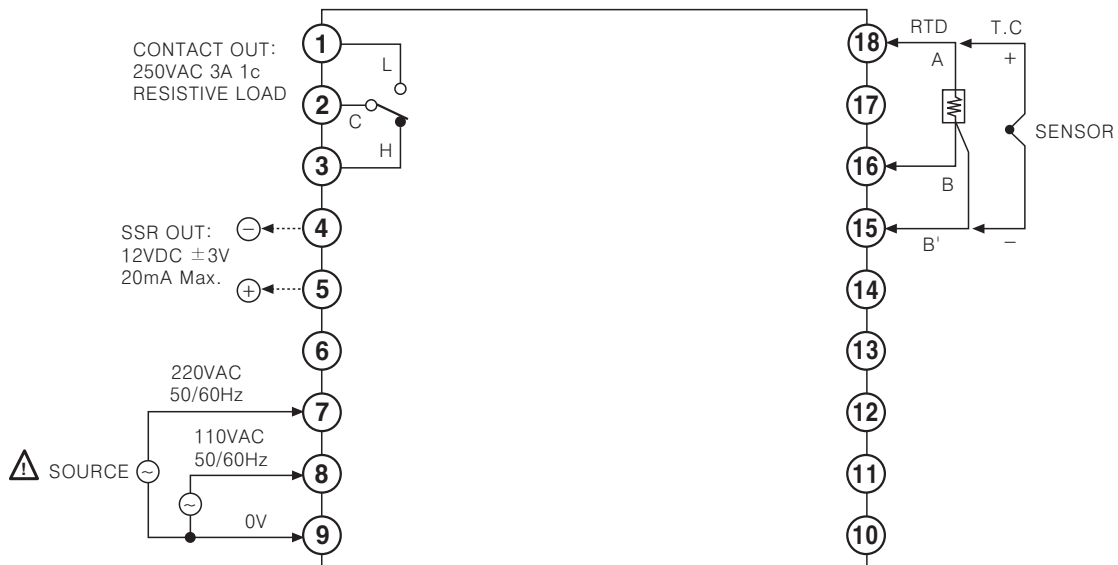

Dimensions

•TOS

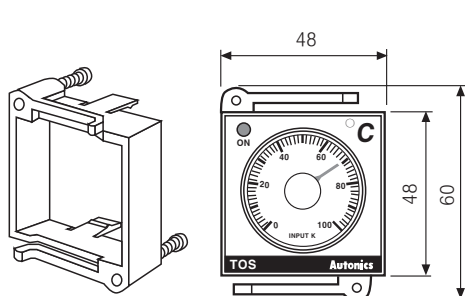

•Panel cut-out

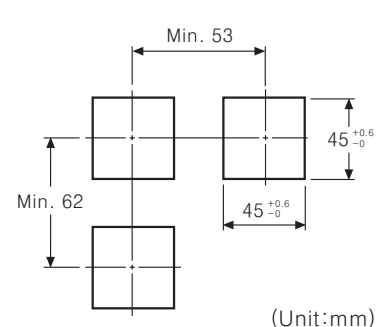

※Socket : PG-08, PS-08(Sold separately)

(Unit:mm)

TOS/TOM/TOL

Dimensions

•TOM

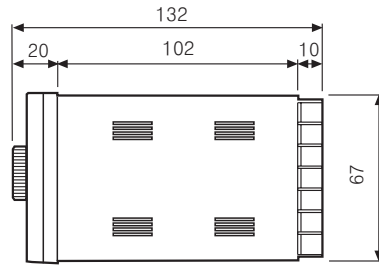
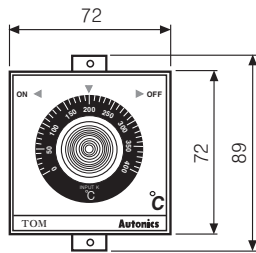

•Panel cut-out

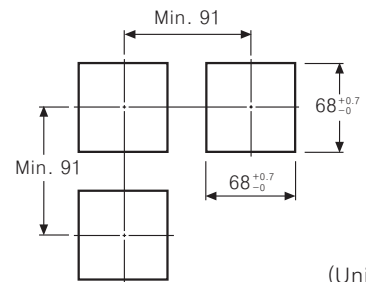

(Unit:mm)

•TOL, TDL

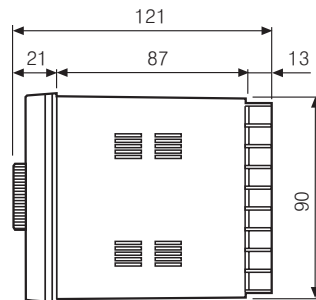
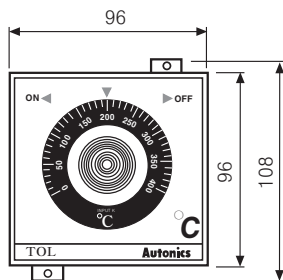

•Panel cut-out

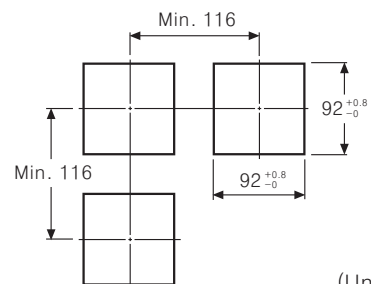

(Unit:mm)

Proper usage

Application of temperature controller and load connection

•SSR output

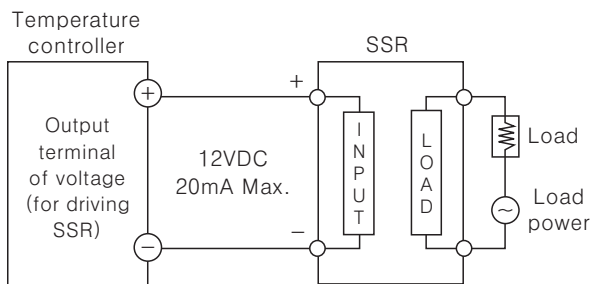

•Relay output

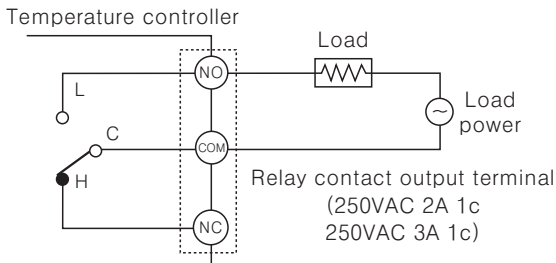

Normal/Reverse operation

Reverse operation executes to output ON when processing value is lower than setting value, and it is used for heating.

Normal operation is executed conversely and used for cooling.

(This item runs as a reverse operation.)

How to select ON/OFF or proportional by plug pin

Factory specification is proportional control.

When using ON/OFF control, transfer the switch of control mode from P to F after detaching the case from its body.

Note) Several models require to change control mode by jump line or solder.

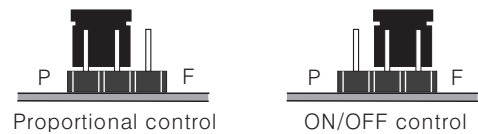

Case detachment

•TOM, TOL

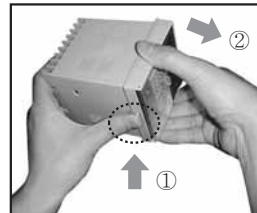

Pressing the front guide of Lock toward ① and squeeze and pull toward ②, it is detached.

•TOS

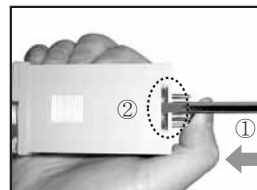

Pressing Pin plug ①, raise it up with a driver as ② and it is detached.