

TLE2426, TLE2426Y THE "RAIL SPLITTER" PRECISION VIRTUAL GROUND

SLOS098D – AUGUST 1991 – REVISED MAY 1998

- 1/2 V_I Virtual Ground for Analog Systems
- Self-Contained 3-terminal TO-226AA Package
- Micropower Operation . . . 170 μA Typ, $V_I = 5\text{ V}$
- Wide V_I Range . . . 4 V to 40 V
- High Output-Current Capability
 - Source . . . 20 mA Typ
 - Sink . . . 20 mA Typ
- Excellent Output Regulation
 - $-45\ \mu\text{V}$ Typ at $I_O = 0$ to $-10\ \text{mA}$
 - $+15\ \mu\text{V}$ Typ at $I_O = 0$ to $+10\ \text{mA}$
- Low-Impedance Output . . . $0.0075\ \Omega$ Typ
- Noise Reduction Pin (D, JG, and P Packages Only)

description

In signal-conditioning applications utilizing a single power source, a reference voltage equal to one-half the supply voltage is required for termination of all analog signal grounds. Texas Instruments presents a precision virtual ground whose output voltage is always equal to one-half the input voltage, the TLE2426 "rail splitter."

The unique combination of a high-performance, micropower operational amplifier and a precision-trimmed divider on a single silicon chip results in a precise V_O/V_I ratio of 0.5 while sinking and sourcing current. The TLE2426 provides a low-impedance output with 20 mA of sink and source capability while drawing less than 280 μA of supply current over the full input range of 4 V to 40 V. A designer need not pay the price in terms of board space for a conventional signal ground consisting of resistors, capacitors, operational amplifiers, and voltage references. The performance and precision of the TLE2426 is available in an easy-to-use, space saving, 3-terminal LP package. For increased performance, the optional 8-pin packages provide a noise-reduction pin. With the addition of an external capacitor (C_{NR}), peak-to-peak noise is reduced while line ripple rejection is improved.

Initial output tolerance for a single 5-V or 12-V system is better than 1% with 3.6% over the full 40-V input range. Ripple rejection exceeds 12 bits of accuracy. Whether the application is for a data acquisition front end, analog signal termination, or simply a precision voltage reference, the TLE2426 eliminates a major source of system error.

INPUT/OUTPUT TRANSFER CHARACTERISTICS

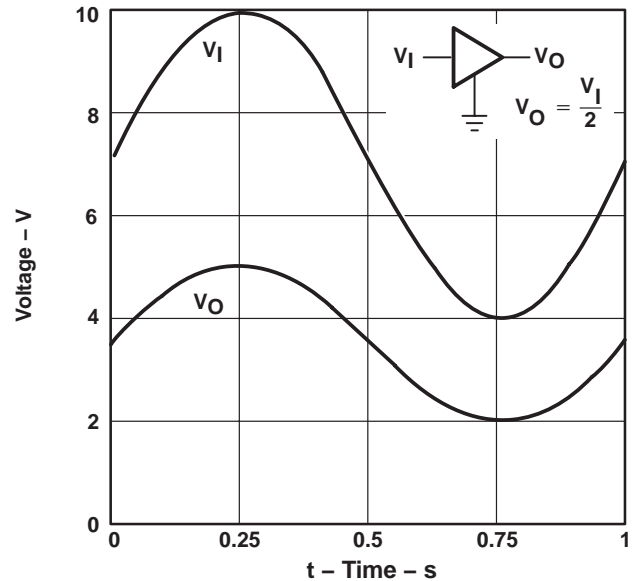

AVAILABLE OPTIONS

PACKAGED DEVICES					CHIP FORM (Y)
T_A	SMALL OUTLINE (D)	CERAMIC DIP (JG)	PLASTIC (LP)	PLASTIC DIP (P)	
0°C to 70°C	TLE2426CD	—	TLE2426CLP	TLE2426CP	



Please be aware that an important notice concerning availability, standard warranty, and use in critical applications of Texas Instruments semiconductor products and disclaimers thereto appears at the end of this data sheet.

PRODUCTION DATA information is current as of publication date. Products conform to specifications per the terms of Texas Instruments standard warranty. Production processing does not necessarily include testing of all parameters.

 **TEXAS
INSTRUMENTS**

POST OFFICE BOX 655303 • DALLAS, TEXAS 75265

Copyright © 1998, Texas Instruments Incorporated

TLE2426, TLE2426Y THE "RAIL SPLITTER" PRECISION VIRTUAL GROUND

SLOS098D – AUGUST 1991 – REVISED MAY 1998

-40°C to 85°C	TLE2426ID	—	TLE2426ILP	TLE2426IP	TLE2426Y
-55°C to 125°C	TLE2426MD	TLE2426MJG	TLE2426MLP	TLE2426MP	

The D and LP packages are available taped and reeled in the commercial temperature range only. Add R suffix to the device type (e. g., TLC2426CDR). Chips are tested at 25°C.



POST OFFICE BOX 655303 • DALLAS, TEXAS 75265

description (continued)

The C-suffix devices are characterized for operation from 0°C to 70°C. The I suffix devices are characterized for operation from -40°C to 85°C. The M suffix devices are characterized over the full military temperature range of -55°C to 125°C.

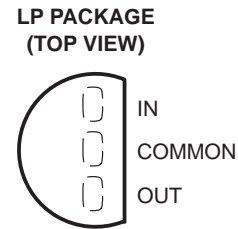
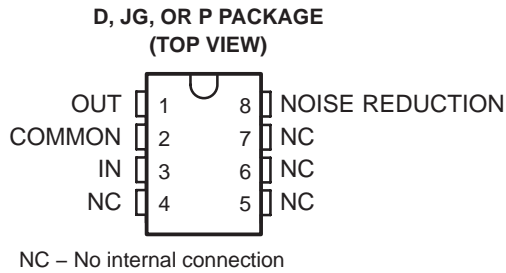

TLE2426Y chip information

This chip, properly assembled, displays characteristics similar to the TLE2426C. Thermal compression or ultrasonic bonding may be used on the doped aluminum bonding pads. The chips may be mounted with conductive epoxy or a gold-silicon preform.

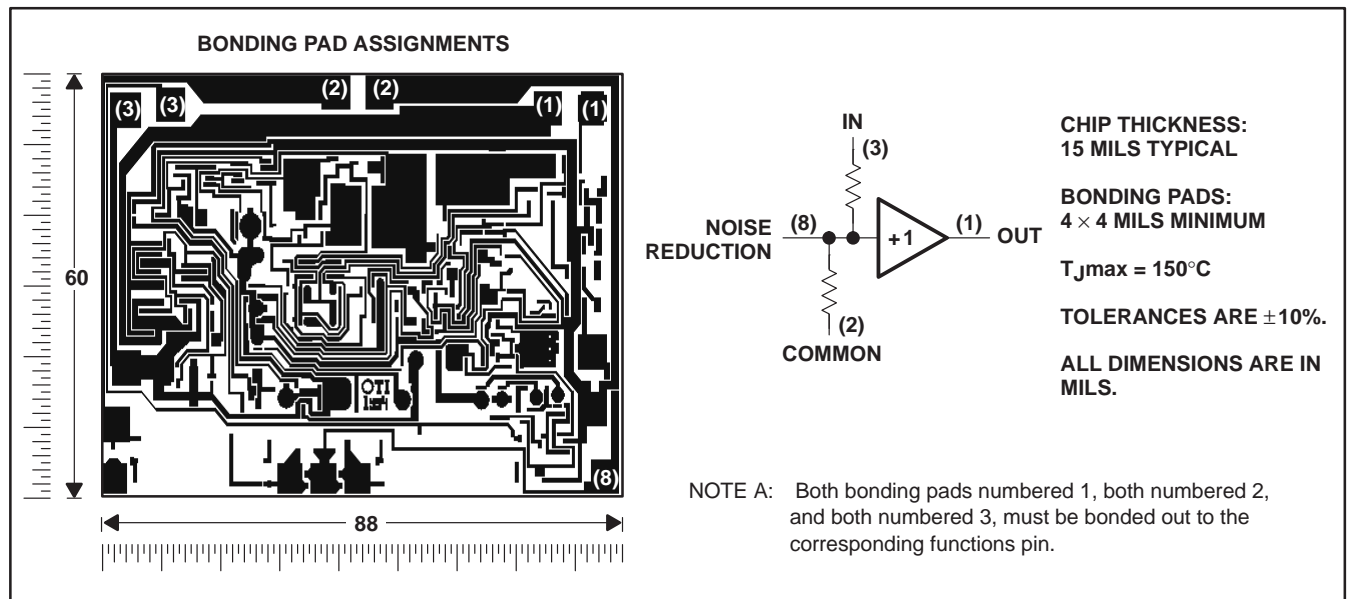

TLE2426, TLE2426Y
THE “RAIL SPLITTER”
PRECISION VIRTUAL GROUND

SLOS098D – AUGUST 1991 – REVISED MAY 1998

absolute maximum ratings over operating free-air temperature (unless otherwise noted)†

- Continuous input voltage, V_I 40 V
- Continuous filter trap voltage 40 V
- Output current, I_O ± 80 mA
- Duration of short-circuit current at (or below) 25°C (see Note 1) unlimited
- Continuous total power dissipation See Dissipation Rating Table
- Operating free-air temperature range, T_A : C suffix 0°C to 70°C
 - I suffix –40°C to 85°C
 - M suffix –55°C to 125°C
- Storage temperature range, T_{stg} –65°C to 150°C
- Lead temperature 1,6 mm (1/16 inch) from case for 10 seconds: D or P package 260°C
- Lead temperature 1,6 mm (1/16 inch) from case for 60 seconds: JG or LP package 300°C

† Stresses beyond those listed under “absolute maximum ratings” may cause permanent damage to the device. These are stress ratings only, and functional operation of the device at these or any other conditions beyond those indicated under “recommended operating conditions” is not implied. Exposure to absolute-maximum-rated conditions for extended periods may affect device reliability.

NOTE 1: The output may be shorted to either supply. Temperature and/or supply voltages must be limited to ensure that the maximum dissipation rating is not exceeded.

DISSIPATION RATING TABLE

PACKAGE	$T_A \leq 25^\circ\text{C}$	DERATING FACTOR	$T_A = 70^\circ\text{C}$	$T_A = 85^\circ\text{C}$	$T_A = 125^\circ\text{C}$
	POWER RATING	ABOVE $T_A = 25^\circ\text{C}$	POWER RATING	POWER RATING	POWER RATING
D	725 mW	5.8 mW/°C	464 mW	377 mW	145 mW
JG	1050 mW	8.4 mW/°C	672 mW	546 mW	210 mW
LP	775 mW	6.2 mW/°C	496 mW	403 mW	155 mW
P	1000 mW	8.0 mW/°C	640 mW	520 mW	200 mW

recommended operating conditions

	C SUFFIX		I SUFFIX		M SUFFIX		UNIT
	MIN	MAX	MIN	MAX	MIN	MAX	
Input voltage, V_I	4	40	4	40	4	40	V
Operating free-air temperature, T_A	0	70	–40	85	–55	125	°C



electrical characteristics at specified free-air temperature, $V_I = 5\text{ V}$, $I_O = 0$ (unless otherwise noted)

PARAMETER	TEST CONDITIONS		T_A †	TLE2426C			UNIT
				MIN	TYP	MAX	
Output voltage	$V_I = 4\text{ V}$		25°C	1.98	2	2.02	V
	$V_I = 5\text{ V}$			2.48	2.5	2.52	
	$V_I = 40\text{ V}$			19.8	20	20.2	
	$V_I = 5\text{ V}$		Full range	2.475		2.525	
Temperature coefficient of output voltage			Full range	25		ppm/°C	
Supply current	No load	$V_I = 5\text{ V}$	25°C	170	300	µA	
		$V_I = 4\text{ to }40\text{ V}$	Full range	400			
Output voltage regulation (sourcing current)‡	$I_O = 0\text{ to }-10\text{ mA}$		25°C	-45	±160	µV	
			Full range	±250			
Output voltage regulation (sinking current)‡	$I_O = 0\text{ to }-20\text{ mA}$		25°C	-150	±450	µV	
			Full range	±250			
Output voltage regulation (sinking current)‡	$I_O = 0\text{ to }10\text{ mA}$		25°C	15	±160	µV	
			Full range	±250			
Output impedance			25°C	7.5	22.5	mΩ	
Noise-reduction impedance			25°C	110		kΩ	
Short-circuit current	Sinking current, $V_O = 5\text{ V}$		25°C	26		mA	
	Sourcing current, $V_O = 0$			-47			
Output noise voltage, rms	$f = 10\text{ Hz to }10\text{ kHz}$	$C_{NR} = 0$	25°C	120		µV	
		$C_{NR} = 1\text{ µF}$		30			
Output voltage current step response	$V_O\text{ to }0.1\%$, $I_O = \pm 10\text{ mA}$	$C_L = 0$	25°C	290		µs	
		$C_L = 100\text{ pF}$		275			
	$V_O\text{ to }0.01\%$, $I_O = \pm 10\text{ mA}$	$C_L = 0$	25°C	400			
		$C_L = 100\text{ pF}$		390			
Step response	$V_I = 0\text{ to }5\text{ V}$, $V_O\text{ to }0.1\%$		25°C	20		µs	
	$V_I = 0\text{ to }5\text{ V}$, $V_O\text{ to }0.01\%$			160			

† Full range is 0°C to 70°C.

‡ The listed values are not production tested.

TLE2426, TLE2426Y
THE “RAIL SPLITTER”
PRECISION VIRTUAL GROUND

SLOS098D – AUGUST 1991 – REVISED MAY 1998

electrical characteristics at specified free-air temperature, $V_I = 12\text{ V}$, $I_O = 0$ (unless otherwise noted)

PARAMETER	TEST CONDITIONS		T_A †	TLE2426C			UNIT
				MIN	TYP	MAX	
Output voltage	$V_I = 4\text{ V}$		25°C	1.98	2	2.02	V
	$V_I = 12\text{ V}$			5.95	6	6.05	
	$V_I = 40\text{ V}$			19.8	20	20.2	
	$V_I = 12\text{ V}$		Full range	5.945		6.055	
Temperature coefficient of output voltage			Full range	35		ppm/°C	
Supply current	No load	$V_I = 12\text{ V}$	25°C	195	300	μA	
		$V_I = 4\text{ to }40\text{ V}$	Full range	400			
Output voltage regulation (sourcing current)‡	$I_O = 0\text{ to }-10\text{ mA}$		25°C	-45	±160	μV	
			Full range	±250			
Output voltage regulation (sinking current)‡	$I_O = 0\text{ to }-20\text{ mA}$		25°C	-150	±450	μV	
			Full range	±250			
Output voltage regulation (sinking current)‡	$I_O = 0\text{ to }10\text{ mA}$		25°C	15	±160	μV	
			Full range	±250			
Output impedance			25°C	7.5	22.5	mΩ	
Noise-reduction impedance			25°C	110		kΩ	
Short-circuit current	Sinking current, $V_O = 12\text{ V}$		25°C	31		mA	
	Sourcing current, $V_O = 0$			-70			
Output noise voltage, rms	$f = 10\text{ Hz to }10\text{ kHz}$	$C_{NR} = 0$	25°C	120		μV	
		$C_{NR} = 1\text{ μF}$		30			
Output voltage current step response	$V_O\text{ to }0.1\%$, $I_O = \pm 10\text{ mA}$	$C_L = 0$	25°C	290		μs	
		$C_L = 100\text{ pF}$		275			
	$V_O\text{ to }0.01\%$, $I_O = \pm 10\text{ mA}$	$C_L = 0$	25°C	400			
		$C_L = 100\text{ pF}$		390			
Step response	$V_I = 0\text{ to }12\text{ V}$, $V_O\text{ to }0.1\%$		25°C	20		μs	
	$V_I = 0\text{ to }12\text{ V}$, $V_O\text{ to }0.01\%$			120			

† Full range is 0°C to 70°C.

‡ The listed values are not production tested.



electrical characteristics at specified free-air temperature, $V_I = 5\text{ V}$, $I_O = 0$ (unless otherwise noted)

PARAMETER	TEST CONDITIONS		T_A †	TLE2426I			UNIT
				MIN	TYP	MAX	
Output voltage	$V_I = 4\text{ V}$		25°C	1.98	2	2.02	V
	$V_I = 5\text{ V}$			2.48	2.5	2.52	
	$V_I = 40\text{ V}$			19.8	20	20.2	
	$V_I = 5\text{ V}$		Full range	2.47		2.53	
Temperature coefficient of output voltage			Full range	25		ppm/°C	
Supply current	No load	$V_I = 5\text{ V}$	25°C	170	300	µA	
		$V_I = 4\text{ to }40\text{ V}$	Full range	400			
Output voltage regulation (sourcing current)‡	$I_O = 0\text{ to }-10\text{ mA}$		25°C	-45	±160	µV	
			Full range	±250			
Output voltage regulation (sinking current)‡	$I_O = 0\text{ to }-20\text{ mA}$		25°C	-150	±450	µV	
			Full range	±250			
Output voltage regulation (sinking current)‡	$I_O = 0\text{ to }10\text{ mA}$		25°C	15	±160	µV	
	$I_O = 0\text{ to }8\text{ mA}$		Full range	±250			
	$I_O = 0\text{ to }20\text{ mA}$		25°C	65	±235		
Output impedance			25°C	7.5	22.5	mΩ	
Noise-reduction impedance			25°C	110		kΩ	
Short-circuit current	Sinking current,	$V_O = 5\text{ V}$	25°C	26		mA	
	Sourcing current,	$V_O = 0$		-47			
Output noise voltage, rms	$f = 10\text{ Hz to }10\text{ kHz}$	$C_{NR} = 0$	25°C	120		µV	
		$C_{NR} = 1\text{ µF}$		30			
Output voltage current step response	$V_O\text{ to }0.1\%$, $I_O = \pm 10\text{ mA}$	$C_L = 0$	25°C	290		µs	
		$C_L = 100\text{ pF}$		275			
	$V_O\text{ to }0.01\%$, $I_O = \pm 10\text{ mA}$	$C_L = 0$	25°C	400			
		$C_L = 100\text{ pF}$		390			
Step response	$V_I = 0\text{ to }5\text{ V}$, $V_O\text{ to }0.1\%$		25°C	20		µs	
	$V_I = 0\text{ to }5\text{ V}$, $V_O\text{ to }0.01\%$			160			

† Full range is -40°C to 85°C.

‡ The listed values are not production tested.

TLE2426, TLE2426Y
THE “RAIL SPLITTER”
PRECISION VIRTUAL GROUND

SLOS098D – AUGUST 1991 – REVISED MAY 1998

electrical characteristics at specified free-air temperature, $V_I = 12\text{ V}$, $I_O = 0$ (unless otherwise noted)

PARAMETER	TEST CONDITIONS		T_A †	TLE2426I			UNIT
				MIN	TYP	MAX	
Output voltage	$V_I = 4\text{ V}$		25°C	1.98	2	2.02	V
	$V_I = 12\text{ V}$			5.95	6	6.05	
	$V_I = 40\text{ V}$			19.8	20	20.2	
	$V_I = 12\text{ V}$		Full range	5.935		6.065	
Temperature coefficient of output voltage			Full range	35		ppm/°C	
Supply current	No load	$V_I = 12\text{ V}$	25°C	195	300	µA	
		$V_I = 4\text{ to }40\text{ V}$	Full range	400			
Output voltage regulation (sourcing current)‡	$I_O = 0\text{ to }-10\text{ mA}$		25°C	-45	±160	µV	
			Full range	±250			
Output voltage regulation (sinking current)‡	$I_O = 0\text{ to }-20\text{ mA}$		25°C	-150	±450	µV	
			Full range	±250			
Output voltage regulation (sinking current)‡	$I_O = 0\text{ to }10\text{ mA}$		25°C	15	±160	µV	
	$I_O = 0\text{ to }8\text{ mA}$		Full range	±250			
	$I_O = 0\text{ to }20\text{ mA}$		25°C	65	±235		
Output impedance			25°C	7.5	22.5	mΩ	
Noise-reduction impedance			25°C	110		kΩ	
Short-circuit current	Sinking current, $V_O = 12\text{ V}$		25°C	31		mA	
	Sourcing current, $V_O = 0$			-70			
Output noise voltage, rms	$f = 10\text{ Hz to }10\text{ kHz}$	$C_{NR} = 0$	25°C	120		µV	
		$C_{NR} = 1\text{ µF}$		30			
Output voltage current step response	$V_O\text{ to }0.1\%$, $I_O = \pm 10\text{ mA}$	$C_L = 0$	25°C	290		µs	
		$C_L = 100\text{ pF}$		275			
	$V_O\text{ to }0.01\%$, $I_O = \pm 10\text{ mA}$	$C_L = 0$	25°C	400			
		$C_L = 100\text{ pF}$		390			
Step response	$V_I = 0\text{ to }12\text{ V}$, $V_O\text{ to }0.1\%$		25°C	20		µs	
	$V_I = 0\text{ to }12\text{ V}$, $V_O\text{ to }0.01\%$			120			

† Full range is -40°C to 85°C.

‡ The listed values are not production tested.



electrical characteristics at specified free-air temperature, $V_I = 5\text{ V}$, $I_O = 0$ (unless otherwise noted)

PARAMETER	TEST CONDITIONS		T_A †	TLE2426M			UNIT
				MIN	TYP	MAX	
Output voltage	$V_I = 4\text{ V}$		25°C	1.98	2	2.02	V
	$V_I = 5\text{ V}$			2.48	2.5	2.52	
	$V_I = 40\text{ V}$			19.8	20	20.2	
	$V_I = 5\text{ V}$		Full range	2.465 2.535			
Temperature coefficient of output voltage			Full range	25		ppm/°C	
Supply current	No load	$V_I = 5\text{ V}$	25°C	170	300	µA	
		$V_I = 4\text{ to }40\text{ V}$	Full range	400			
Output voltage regulation (sourcing current)‡	$I_O = 0\text{ to }-10\text{ mA}$		25°C	-45	±160	µV	
			Full range	±250			
Output voltage regulation (sinking current)‡	$I_O = 0\text{ to }-20\text{ mA}$		25°C	-150	±450	µV	
			Full range	±250			
Output voltage regulation (sinking current)‡	$I_O = 0\text{ to }10\text{ mA}$		25°C	15	±160	µV	
	$I_O = 0\text{ to }3\text{ mA}$		Full range	±250			
	$I_O = 0\text{ to }20\text{ mA}$		25°C	65	±235		
Output impedance			25°C	7.5	22.5	mΩ	
Noise-reduction impedance			25°C	110		kΩ	
Short-circuit current	Sinking current, $V_O = 5\text{ V}$		25°C	26		mA	
	Sourcing current, $V_O = 0$			-47			
Output noise voltage, rms	$f = 10\text{ Hz to }10\text{ kHz}$	$C_{NR} = 0$	25°C	120		µV	
		$C_{NR} = 1\text{ µF}$		30			
Output voltage current step response	$V_O\text{ to }0.1\%$, $I_O = \pm 10\text{ mA}$	$C_L = 0$	25°C	290		µs	
		$C_L = 100\text{ pF}$		275			
	$V_O\text{ to }0.01\%$, $I_O = \pm 10\text{ mA}$	$C_L = 0$	25°C	400			
		$C_L = 100\text{ pF}$		390			
Step response	$V_I = 0\text{ to }5\text{ V}$, $V_O\text{ to }0.1\%$		25°C	20		µs	
	$V_I = 0\text{ to }5\text{ V}$, $V_O\text{ to }0.01\%$			120			

† Full range is -55°C to 125°C.

‡ The listed values are not production tested.

TLE2426, TLE2426Y
THE “RAIL SPLITTER”
PRECISION VIRTUAL GROUND

SLOS098D – AUGUST 1991 – REVISED MAY 1998

electrical characteristics at specified free-air temperature, $V_I = 12\text{ V}$, $I_O = 0$ (unless otherwise noted)

PARAMETER	TEST CONDITIONS		T_A †	TLE2426M			UNIT
				MIN	TYP	MAX	
Output voltage	$V_I = 4\text{ V}$		25°C	1.98	2	2.02	V
	$V_I = 12\text{ V}$			5.95	6	6.05	
	$V_I = 40\text{ V}$			19.8	20	20.2	
	$V_I = 12\text{ V}$		Full range	5.925		6.075	
Temperature coefficient of output voltage			Full range	35		ppm/°C	
Supply current	No load	$V_I = 12\text{ V}$	25°C	195	250	μA	
		$V_I = 4\text{ to }40\text{ V}$	Full range	350			
Output voltage regulation (sourcing current)‡	$I_O = 0\text{ to }-10\text{ mA}$		25°C	-45	±160	μV	
			Full range	±250			
Output voltage regulation (sinking current)‡	$I_O = 0\text{ to }-20\text{ mA}$		25°C	-150	±450	μV	
			Full range	±250			
Output voltage regulation (sinking current)‡	$I_O = 0\text{ to }10\text{ mA}$		25°C	15	±160	μV	
	$I_O = 0\text{ to }8\text{ mA}$		Full range	±250			
	$I_O = 0\text{ to }20\text{ mA}$		25°C	65	±235		
Output impedance			25°C	7.5	22.5	mΩ	
Noise-reduction impedance			25°C	110		kΩ	
Short-circuit current	Sinking current, $V_O = 12\text{ V}$		25°C	31		mA	
	Sourcing current, $V_O = 0$			-70			
Output noise voltage, rms	$f = 10\text{ Hz to }10\text{ kHz}$	$C_{NR} = 0$	25°C	120		μV	
		$C_{NR} = 1\text{ μF}$		30			
Output voltage current step response	$V_O\text{ to }0.1\%$, $I_O = \pm 10\text{ mA}$	$C_L = 0$	25°C	290		μs	
		$C_L = 100\text{ pF}$		275			
	$V_O\text{ to }0.01\%$, $I_O = \pm 10\text{ mA}$	$C_L = 0$	25°C	400			
		$C_L = 100\text{ pF}$		390			
Step response	$V_I = 0\text{ to }12\text{ V}$, $V_O\text{ to }0.1\%$		25°C	12		μs	
	$V_I = 0\text{ to }12\text{ V}$, $V_O\text{ to }0.01\%$			120			

† Full range is -55°C to 125°C.

‡ The listed values are not production tested.



electrical characteristics at specified free-air temperature, $V_I = 5\text{ V}$, $I_O = 0$, $T_A = 25^\circ\text{C}$ (unless otherwise noted)

PARAMETER	TEST CONDITIONS	TLE2426Y			UNIT
		MIN	TYP	MAX	
Output voltage	$V_I = 5\text{ V}$	2.5			V
Supply current	No load	170			μA
Output voltage regulation (sourcing current) [†]	$I_O = 0$ to -10 mA	-45			μV
	$I_O = 0$ to -20 mA	-150			
Output voltage regulation (sinking current) [†]	$I_O = 0$ to 10 mA	15			μV
	$I_O = 0$ to 20 mA	65			
Output impedance		7.5			$\text{m}\Omega$
Noise-reduction impedance		110			$\text{k}\Omega$
Short-circuit current	Sinking current, $V_O = 5\text{ V}$	26			mA
	Sourcing current, $V_O = 0$	-47			
Output noise voltage, rms	$f = 10\text{ Hz}$ to 10 kHz	$C_{NR} = 0$	120		μV
		$C_{NR} = 1\ \mu\text{F}$	30		
Output voltage current step response	V_O to 0.1%, $I_O = \pm 10\text{ mA}$	$C_L = 0$	290		μs
		$C_L = 100\ \text{pF}$	275		
	V_O to 0.01%, $I_O = \pm 10\text{ mA}$	$C_L = 0$	400		
		$C_L = 100\ \text{pF}$	390		
Step response	$V_I = 0$ to 5 V , V_O to 0.1%	$C_L = 100\ \text{pF}$	20		μs
	$V_I = 0$ to 5 V , V_O to 0.01%		160		

[†] The listed values are not production tested.

electrical characteristics at specified free-air temperature, $V_I = 12\text{ V}$, $I_O = 0$, $T_A = 25^\circ\text{C}$ (unless otherwise noted)

PARAMETER	TEST CONDITIONS	TLE2426Y			UNIT
		MIN	TYP	MAX	
Output voltage	$V_I = 12\text{ V}$	6			V
Supply current	No load	195			μA
Output voltage regulation (sourcing current) [†]	$I_O = 0$ to -10 mA	-45			μV
	$I_O = 0$ to -20 mA	-150			
Output voltage regulation (sinking current) [†]	$I_O = 0$ to 3 mA	15			μV
	$I_O = 0$ to 20 mA	65			
Output impedance		7.5			$\text{m}\Omega$
Noise-reduction impedance		110			$\text{k}\Omega$
Short-circuit current	Sinking current, $V_O = 12\text{ V}$	31			mA
	Sourcing current, $V_O = 0$	-70			
Output noise voltage, rms	$f = 10\text{ Hz}$ to 10 kHz	$C_{NR} = 0$	120		μV
		$C_{NR} = 1\ \mu\text{F}$	30		
Output voltage current, step response	V_O to 0.1%, $I_O = \pm 10\text{ mA}$	$C_L = 0$	290		μs
		$C_L = 100\ \text{pF}$	275		
	V_O to 0.01%, $I_O = \pm 10\text{ mA}$	$C_L = 0$	400		
		$C_L = 100\ \text{pF}$	390		
Step response	$V_I = 0$ to 12 V , V_O to 0.1%	$C_L = 100\ \text{pF}$	12		μs
	$V_I = 0$ to 12 V , V_O to 0.01%		120		

[†] The listed values are not production tested.

TYPICAL CHARACTERISTICS

Table Of Graphs

		FIGURE
Output voltage	Distribution	1,2
Output voltage change	vs Free-air temperature	3
Output voltage error	vs Input voltage	4
Input bias current	vs Input voltage	5
	vs Free-air temperature	6
Output voltage regulation	vs Output current	7
Output impedance	vs Frequency	8
Short-circuit output current	vs Input voltage	9,10
	vs Free-air temperature	11,12
Ripple rejection	vs Frequency	13
Spectral noise voltage density	vs Frequency	14
Output voltage response to output current step	vs Time	15
Output voltage power-up response	vs Time	16
Output current	vs Load capacitance	17

TYPICAL CHARACTERISTICS†

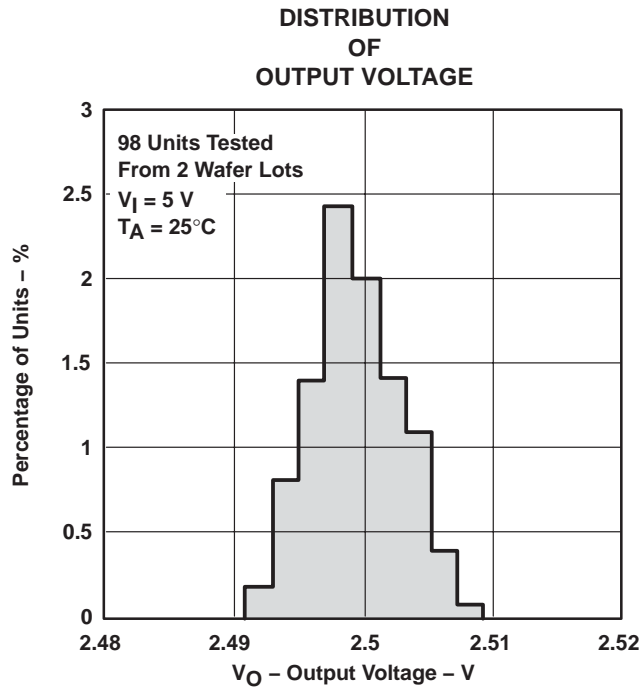

Figure 1

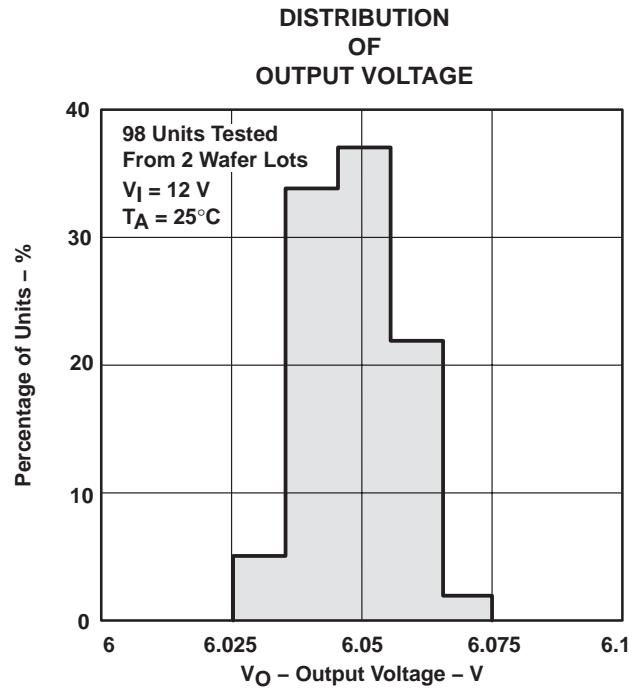

Figure 2

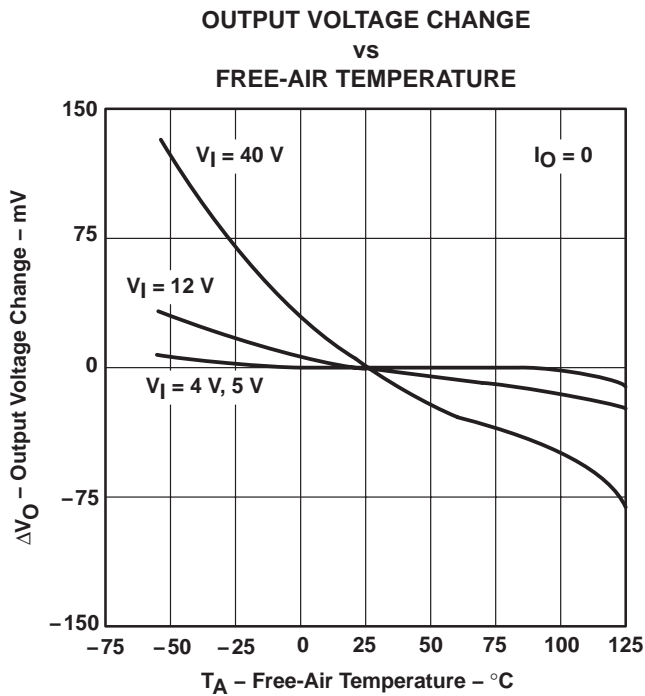

Figure 3

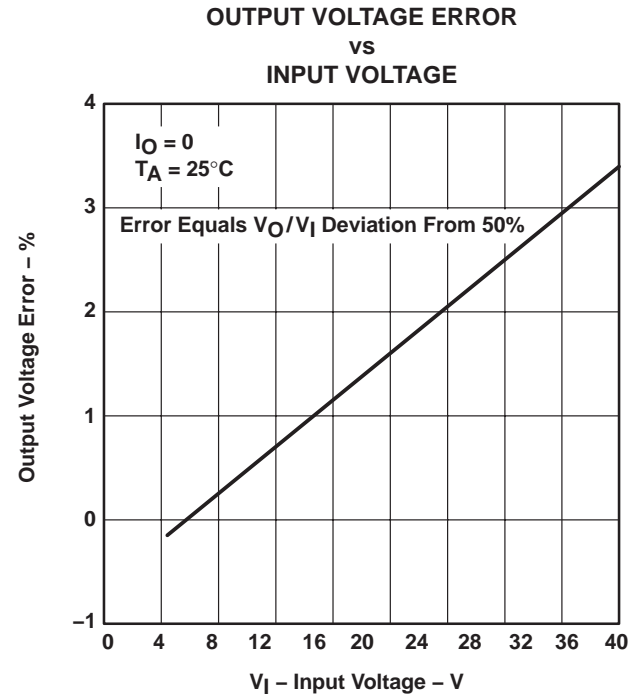

Figure 4

† Data at high and low temperatures are applicable within the rated operating free-air temperature ranges of the various devices.

TYPICAL CHARACTERISTICS†

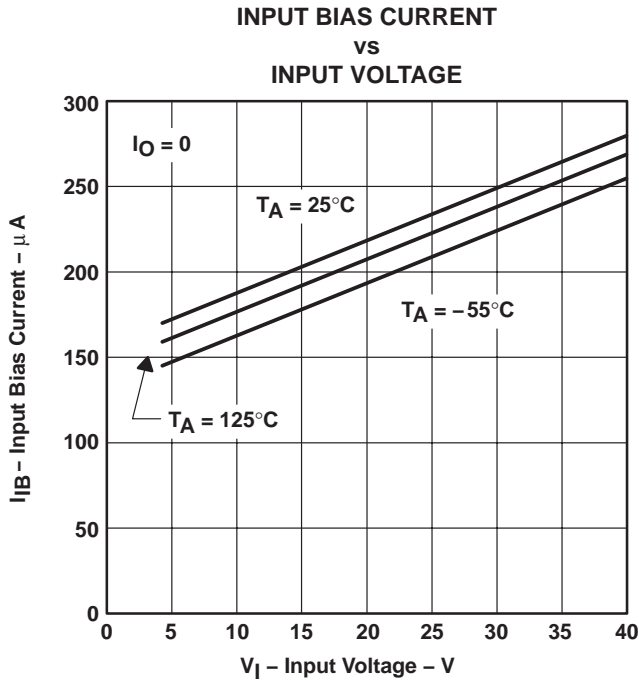

Figure 5

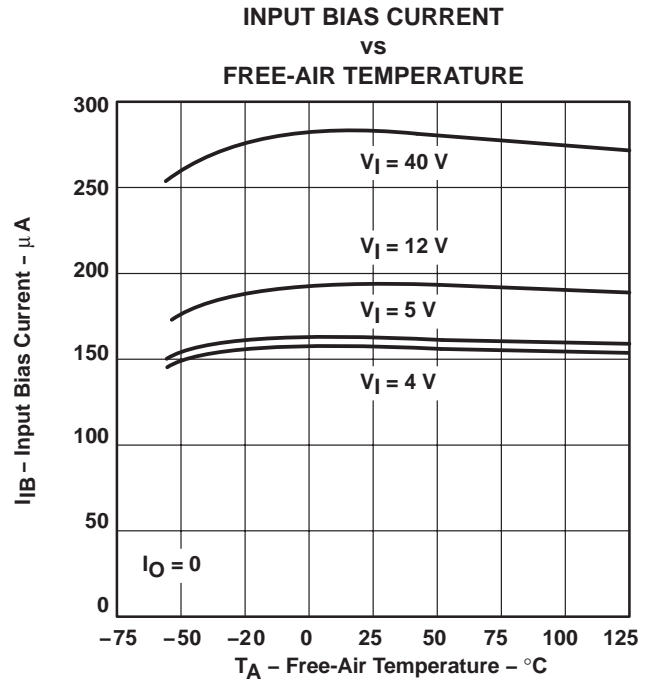

Figure 6

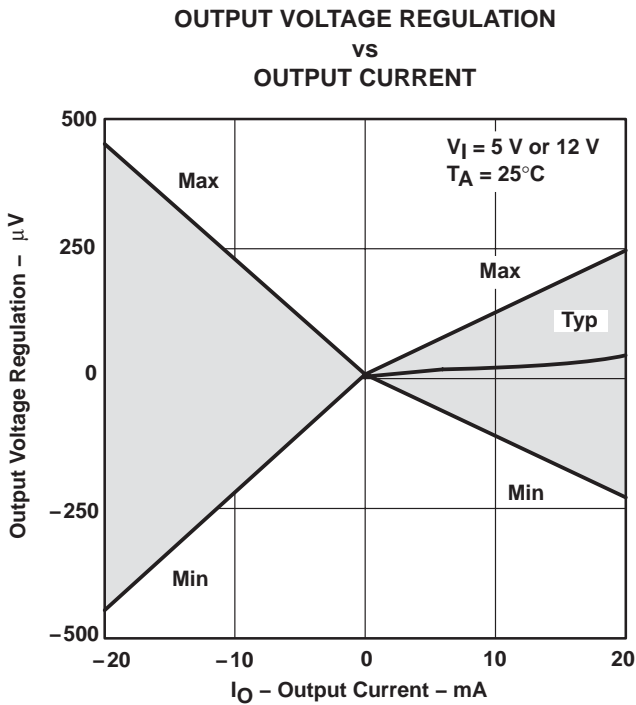

Figure 7

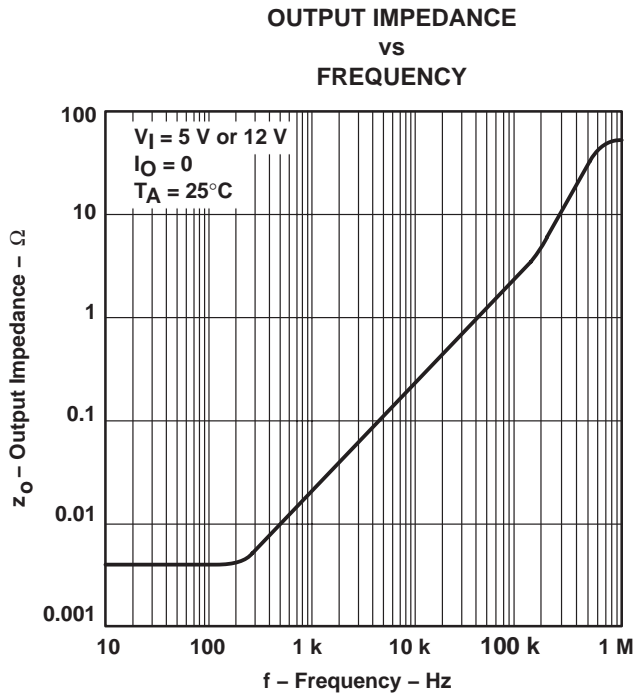

Figure 8

† Data at high and low temperatures are applicable within the rated operating free-air temperature ranges of the various devices.

TYPICAL CHARACTERISTICS†

SHORT-CIRCUIT OUTPUT CURRENT
 vs
 INPUT VOLTAGE

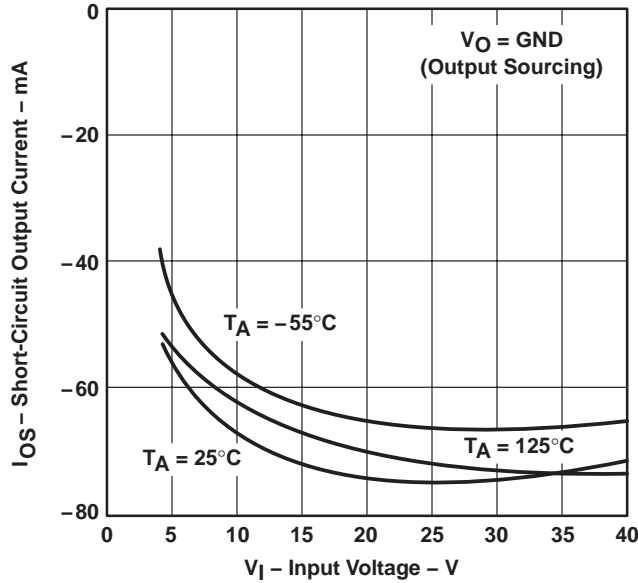

Figure 9

SHORT-CIRCUIT OUTPUT CURRENT
 vs
 INPUT VOLTAGE

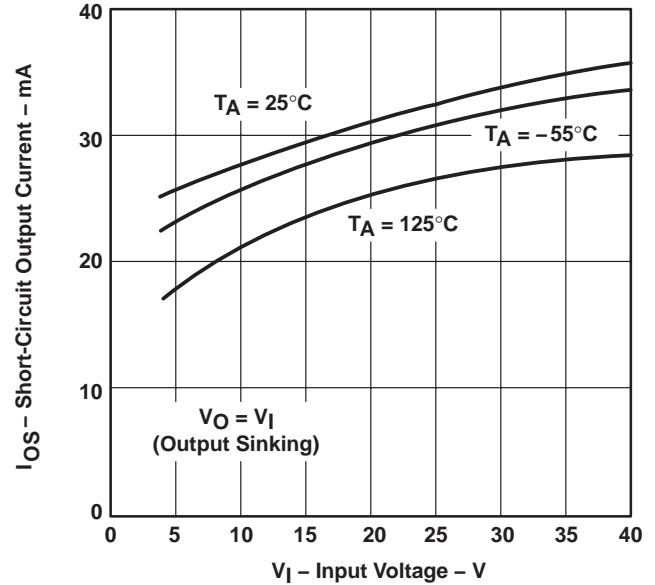

Figure 10

SHORT-CIRCUIT OUTPUT CURRENT
 vs
 FREE-AIR TEMPERATURE

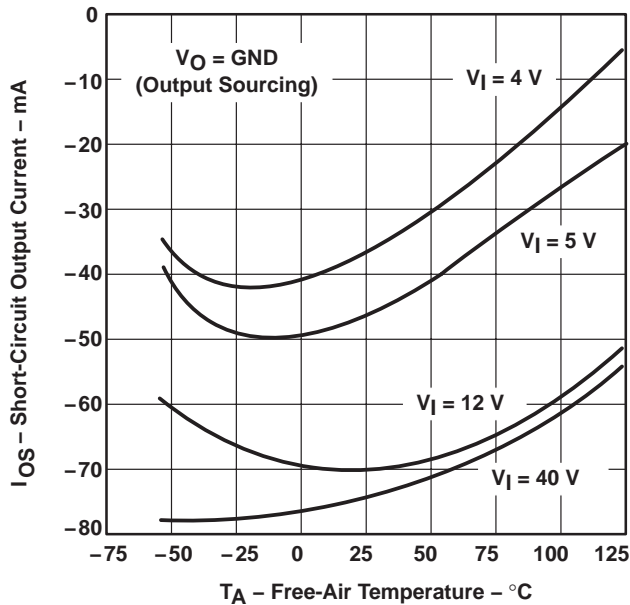

Figure 11

SHORT-CIRCUIT OUTPUT CURRENT
 vs
 FREE-AIR TEMPERATURE

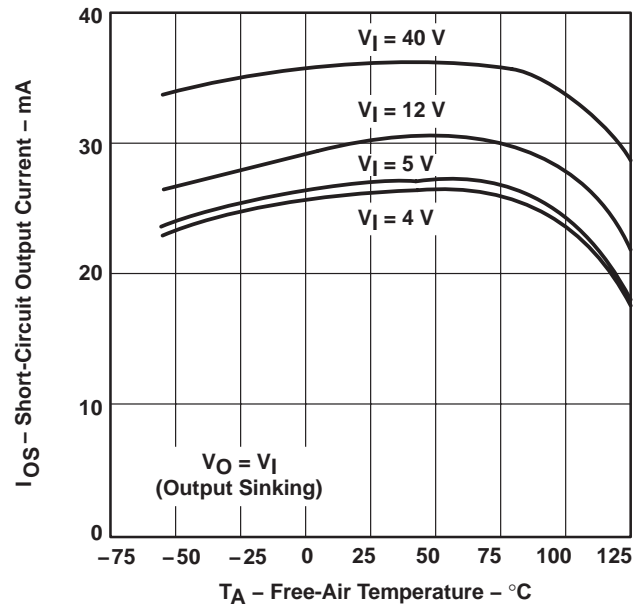

Figure 12

† Data at high and low temperatures are applicable within the rated operating free-air temperature ranges of the various devices.

TLE2426, TLE2426Y
THE "RAIL SPLITTER"
PRECISION VIRTUAL GROUND

SLOS098D – AUGUST 1991 – REVISED MAY 1998

TYPICAL CHARACTERISTICS

**RIPPLE REJECTION
 vs
 FREQUENCY**

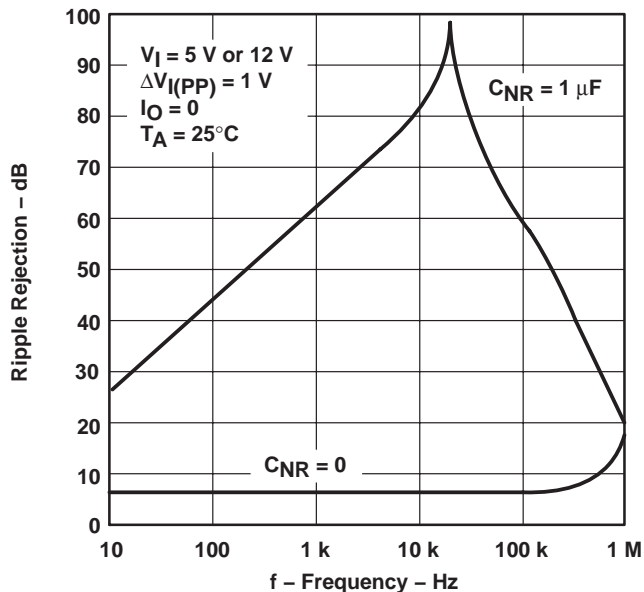

Figure 13

**SPECTRAL NOISE VOLTAGE DENSITY
 vs
 FREQUENCY**

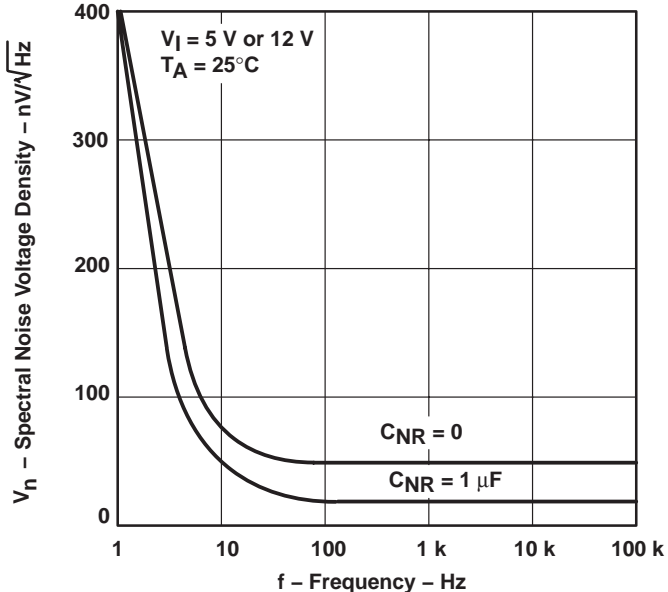

Figure 14

**OUTPUT VOLTAGE RESPONSE
 TO OUTPUT CURRENT STEP**

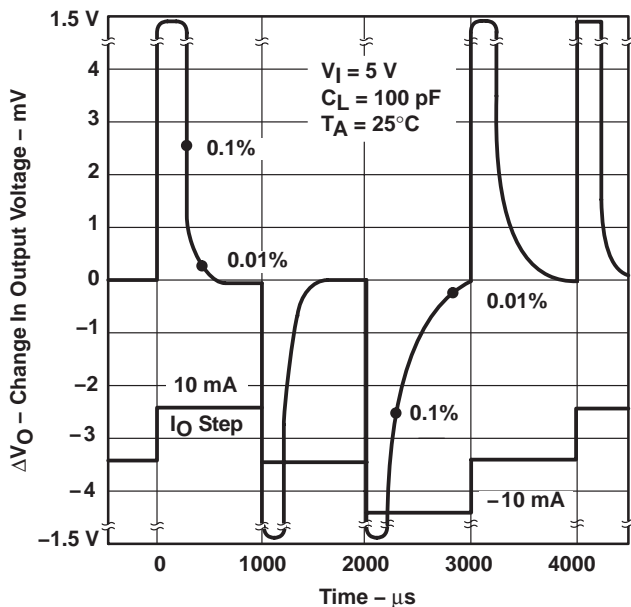

Figure 15

OUTPUT VOLTAGE POWER-UP RESPONSE

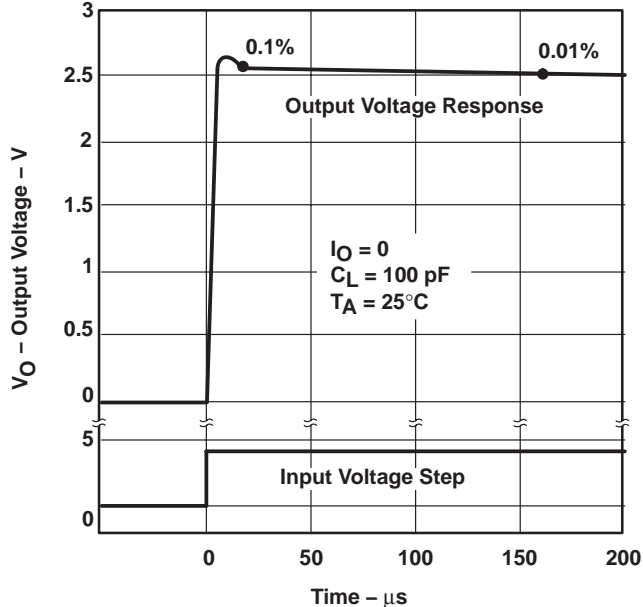

Figure 16



TYPICAL CHARACTERISTICS

STABILITY RANGE
OUTPUT CURRENT
VS
LOAD CAPACITANCE

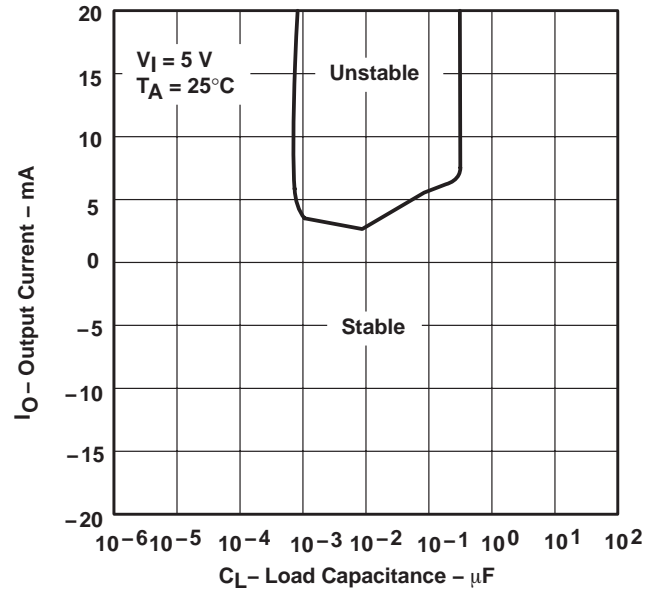

Figure 17

TLE2426, TLE2426Y THE "RAIL SPLITTER" PRECISION VIRTUAL GROUND

SLOS098D - AUGUST 1991 - REVISED MAY 1998

MACROMODEL INFORMATION

* TLE2426 OPERATIONAL AMPLIFIER "MACROMODEL" SUBCIRCUIT
 * CREATED USING PARTS RELEASE 4.03 ON 08/21/90 AT 13:51
 * REV (N/A) SUPPLY VOLTAGE: 5 V
 * CONNECTIONS:

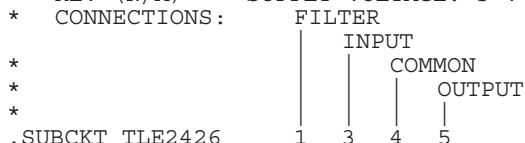

```

C1      11 12 21.66E-12
C2      6  7 30.00E-12
C3      87  0 10.64E-9
CPSR    85 86 15.9E-9
DCM+    81 82 DX
DCM-    83 81 DX
DC      5 53 DX
DE      54  5 DX
DLP     90 91 DX
DLN     92 90 DX
DP      4  3 DX
ECMR    84 99 (2,99) 1
EGND    99  0 POLY(2) (3,0) (4,0) 0 .5 .5
EPSR    85 0 POLY(1) (3,4) -16.22E-6 3.24E-6
ENSE    89 2 POLY(1) (88,0) 120E-6 1
FB      7 99 POLY(6) VB VC VE VLP VLN VPSR 0 74.8E6 -10E6 10E6 10E6 -10E6 74E6
GA      6  0 11 12 320.4E-6
GCM     0  6 10 99 1.013E-9
GPSR    85 86 (85,86) 100E-6
GRC1    4 11 (4,11) 3.204E-4
GRC2    4 12 (4,12) 3.204E-4
GRE1    13 10 (13,10) 1.038E-3
GRE2    14 10 (14,10) 1.038E-3
HLIM    90  0 VLIM 1K
HCMR    80 1 POLY(2) VCM+ VCM- 0 1E2 1E2
IRP     3  4 146E-6
IEE     3 10 DC 24.05E-6
IIO     2  0 .2E-9
I1      88  0 1E-21
Q1      11 89 13 QX
Q2      12 80 14 QX
R2      6  9 100.0E3
RCM     84 81 1K
REE     10 99 8.316E6
RN1     87  0 2.55E8
RN2     87 88 11.67E3
RO1     8  5 63
RO2     7 99 62
VCM+    82 99 1.0
VCM-    83 99 -2.3
VB      9  0 DC 0
VC      3 53 DC 1.400
VE      54  4 DC 1.400
VLIM    7  8 DC 0
VLP     91  0 DC 30
VLN     0 92 DC 30
VPSR    0 86 DC 0
RFB     5  2 1K
RIN1    3  1 220K
RIN2    1  4 220K
.MODEL DX D(IS=800.OE-18)
.MODEL QX PNP(IS=800.OE-18 BF=480)
.ENDS
  
```



PACKAGING INFORMATION

Orderable Device	Status (1)	Package Type	Package Drawing	Pins	Package Qty	Eco Plan (2)	Lead finish/ Ball material (6)	MSL Peak Temp (3)	Op Temp (°C)	Device Marking (4/5)	Samples
TLE2426CD	ACTIVE	SOIC	D	8	75	RoHS & Green	NIPDAU	Level-1-260C-UNLIM		2426C	Samples
TLE2426CDG4	ACTIVE	SOIC	D	8	75	RoHS & Green	NIPDAU	Level-1-260C-UNLIM		2426C	Samples
TLE2426CDR	ACTIVE	SOIC	D	8	2500	RoHS & Green	NIPDAU	Level-1-260C-UNLIM		2426C	Samples
TLE2426CLP	ACTIVE	TO-92	LP	3	1000	RoHS & Green	SN	N / A for Pkg Type		2426C	Samples
TLE2426CLPE3	ACTIVE	TO-92	LP	3	1000	RoHS & Green	SN	N / A for Pkg Type		2426C	Samples
TLE2426CLPR	ACTIVE	TO-92	LP	3	2000	RoHS & Green	SN	N / A for Pkg Type		2426C	Samples
TLE2426CP	ACTIVE	PDIP	P	8	50	RoHS & Green	NIPDAU	N / A for Pkg Type		TLE2426CP	Samples
TLE2426ID	ACTIVE	SOIC	D	8	75	RoHS & Green	NIPDAU	Level-1-260C-UNLIM		2426I	Samples
TLE2426IDG4	ACTIVE	SOIC	D	8	75	RoHS & Green	NIPDAU	Level-1-260C-UNLIM		2426I	Samples
TLE2426IDR	ACTIVE	SOIC	D	8	2500	RoHS & Green	NIPDAU	Level-1-260C-UNLIM		2426I	Samples
TLE2426ILP	ACTIVE	TO-92	LP	3	1000	RoHS & Green	SN	N / A for Pkg Type		2426I	Samples
TLE2426ILPR	ACTIVE	TO-92	LP	3	2000	RoHS & Green	SN	N / A for Pkg Type		2426I	Samples
TLE2426IP	ACTIVE	PDIP	P	8	50	RoHS & Green	NIPDAU	N / A for Pkg Type		TLE2426IP	Samples
TLE2426IPE4	ACTIVE	PDIP	P	8	50	RoHS & Green	NIPDAU	N / A for Pkg Type		TLE2426IP	Samples
TLE2426MD	ACTIVE	SOIC	D	8	75	RoHS & Green	NIPDAU	Level-1-260C-UNLIM	-55 to 125	2426M	Samples

(1) The marketing status values are defined as follows:

ACTIVE: Product device recommended for new designs.

LIFEBUY: TI has announced that the device will be discontinued, and a lifetime-buy period is in effect.

NRND: Not recommended for new designs. Device is in production to support existing customers, but TI does not recommend using this part in a new design.

PREVIEW: Device has been announced but is not in production. Samples may or may not be available.

OBSELETE: TI has discontinued the production of the device.

(2) **RoHS:** TI defines "RoHS" to mean semiconductor products that are compliant with the current EU RoHS requirements for all 10 RoHS substances, including the requirement that RoHS substance do not exceed 0.1% by weight in homogeneous materials. Where designed to be soldered at high temperatures, "RoHS" products are suitable for use in specified lead-free processes. TI may reference these types of products as "Pb-Free".

RoHS Exempt: TI defines "RoHS Exempt" to mean products that contain lead but are compliant with EU RoHS pursuant to a specific EU RoHS exemption.

Green: TI defines "Green" to mean the content of Chlorine (Cl) and Bromine (Br) based flame retardants meet JS709B low halogen requirements of ≤ 1000 ppm threshold. Antimony trioxide based flame retardants must also meet the ≤ 1000 ppm threshold requirement.

(3) MSL, Peak Temp. - The Moisture Sensitivity Level rating according to the JEDEC industry standard classifications, and peak solder temperature.

(4) There may be additional marking, which relates to the logo, the lot trace code information, or the environmental category on the device.

(5) Multiple Device Markings will be inside parentheses. Only one Device Marking contained in parentheses and separated by a "~" will appear on a device. If a line is indented then it is a continuation of the previous line and the two combined represent the entire Device Marking for that device.

(6) Lead finish/Ball material - Orderable Devices may have multiple material finish options. Finish options are separated by a vertical ruled line. Lead finish/Ball material values may wrap to two lines if the finish value exceeds the maximum column width.

Important Information and Disclaimer: The information provided on this page represents TI's knowledge and belief as of the date that it is provided. TI bases its knowledge and belief on information provided by third parties, and makes no representation or warranty as to the accuracy of such information. Efforts are underway to better integrate information from third parties. TI has taken and continues to take reasonable steps to provide representative and accurate information but may not have conducted destructive testing or chemical analysis on incoming materials and chemicals. TI and TI suppliers consider certain information to be proprietary, and thus CAS numbers and other limited information may not be available for release.

In no event shall TI's liability arising out of such information exceed the total purchase price of the TI part(s) at issue in this document sold by TI to Customer on an annual basis.

OTHER QUALIFIED VERSIONS OF TLE2426 :

● Automotive : [TLE2426-Q1](#)

● Enhanced Product : [TLE2426-EP](#)

NOTE: Qualified Version Definitions:

- Automotive - Q100 devices qualified for high-reliability automotive applications targeting zero defects
- Enhanced Product - Supports Defense, Aerospace and Medical Applications

TAPE AND REEL INFORMATION

QUADRANT ASSIGNMENTS FOR PIN 1 ORIENTATION IN TAPE



*All dimensions are nominal

Device	Package Type	Package Drawing	Pins	SPQ	Reel Diameter (mm)	Reel Width W1 (mm)	A0 (mm)	B0 (mm)	K0 (mm)	P1 (mm)	W (mm)	Pin1 Quadrant
TLE2426CDR	SOIC	D	8	2500	330.0	12.4	6.4	5.2	2.1	8.0	12.0	Q1
TLE2426IDR	SOIC	D	8	2500	330.0	12.4	6.4	5.2	2.1	8.0	12.0	Q1

TAPE AND REEL BOX DIMENSIONS

*All dimensions are nominal

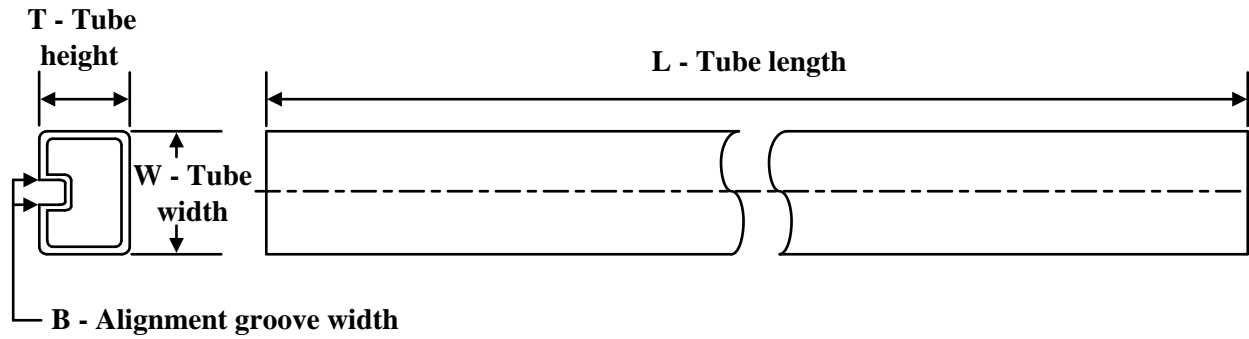
Device	Package Type	Package Drawing	Pins	SPQ	Length (mm)	Width (mm)	Height (mm)
TLE2426CDR	SOIC	D	8	2500	350.0	350.0	43.0
TLE2426IDR	SOIC	D	8	2500	350.0	350.0	43.0

TUBE

*All dimensions are nominal

Device	Package Name	Package Type	Pins	SPQ	L (mm)	W (mm)	T (μm)	B (mm)
TLE2426CD	D	SOIC	8	75	505.46	6.76	3810	4
TLE2426CDG4	D	SOIC	8	75	505.46	6.76	3810	4
TLE2426CP	P	PDIP	8	50	506	13.97	11230	4.32
TLE2426ID	D	SOIC	8	75	505.46	6.76	3810	4
TLE2426IDG4	D	SOIC	8	75	505.46	6.76	3810	4
TLE2426IP	P	PDIP	8	50	506	13.97	11230	4.32
TLE2426IPE4	P	PDIP	8	50	506	13.97	11230	4.32
TLE2426MD	D	SOIC	8	75	505.46	6.76	3810	4



D0008A

PACKAGE OUTLINE

SOIC - 1.75 mm max height

SMALL OUTLINE INTEGRATED CIRCUIT



NOTES:

1. Linear dimensions are in inches [millimeters]. Dimensions in parenthesis are for reference only. Controlling dimensions are in inches. Dimensioning and tolerancing per ASME Y14.5M.
2. This drawing is subject to change without notice.
3. This dimension does not include mold flash, protrusions, or gate burrs. Mold flash, protrusions, or gate burrs shall not exceed .006 [0.15] per side.
4. This dimension does not include interlead flash.
5. Reference JEDEC registration MS-012, variation AA.

EXAMPLE BOARD LAYOUT

D0008A

SOIC - 1.75 mm max height

SMALL OUTLINE INTEGRATED CIRCUIT



LAND PATTERN EXAMPLE
EXPOSED METAL SHOWN
SCALE:8X



SOLDER MASK DETAILS

4214825/C 02/2019

NOTES: (continued)

- 6. Publication IPC-7351 may have alternate designs.
- 7. Solder mask tolerances between and around signal pads can vary based on board fabrication site.

EXAMPLE STENCIL DESIGN

D0008A

SOIC - 1.75 mm max height

SMALL OUTLINE INTEGRATED CIRCUIT



SOLDER PASTE EXAMPLE
BASED ON .005 INCH [0.125 MM] THICK STENCIL
SCALE:8X

4214825/C 02/2019

NOTES: (continued)

8. Laser cutting apertures with trapezoidal walls and rounded corners may offer better paste release. IPC-7525 may have alternate design recommendations.
9. Board assembly site may have different recommendations for stencil design.

P (R-PDIP-T8)

PLASTIC DUAL-IN-LINE PACKAGE



- NOTES:
- A. All linear dimensions are in inches (millimeters).
 - B. This drawing is subject to change without notice.
 - C. Falls within JEDEC MS-001 variation BA.

GENERIC PACKAGE VIEW

LP 3

TO-92 - 5.34 mm max height

TRANSISTOR OUTLINE



Images above are just a representation of the package family, actual package may vary.
Refer to the product data sheet for package details.

4040001-2/F

LP0003A



PACKAGE OUTLINE

TO-92 - 5.34 mm max height

TO-92



4215214/B 04/2017

NOTES:

1. All linear dimensions are in millimeters. Any dimensions in parenthesis are for reference only. Dimensioning and tolerancing per ASME Y14.5M.
2. This drawing is subject to change without notice.
3. Lead dimensions are not controlled within this area.
4. Reference JEDEC TO-226, variation AA.
5. Shipping method:
 - a. Straight lead option available in bulk pack only.
 - b. Formed lead option available in tape and reel or ammo pack.
 - c. Specific products can be offered in limited combinations of shipping medium and lead options.
 - d. Consult product folder for more information on available options.

EXAMPLE BOARD LAYOUT

LP0003A

TO-92 - 5.34 mm max height

TO-92

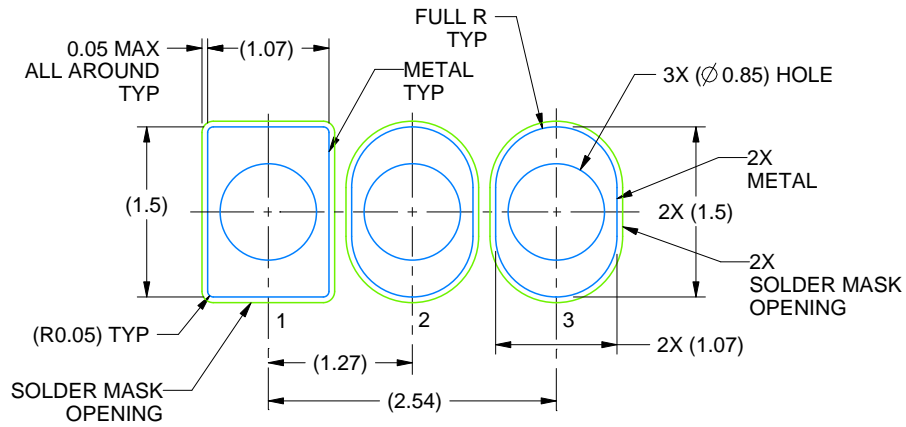

LAND PATTERN EXAMPLE
STRAIGHT LEAD OPTION
NON-SOLDER MASK DEFINED
SCALE:15X



LAND PATTERN EXAMPLE
FORMED LEAD OPTION
NON-SOLDER MASK DEFINED
SCALE:15X

4215214/B 04/2017

TAPE SPECIFICATIONS

LP0003A

TO-92 - 5.34 mm max height

TO-92

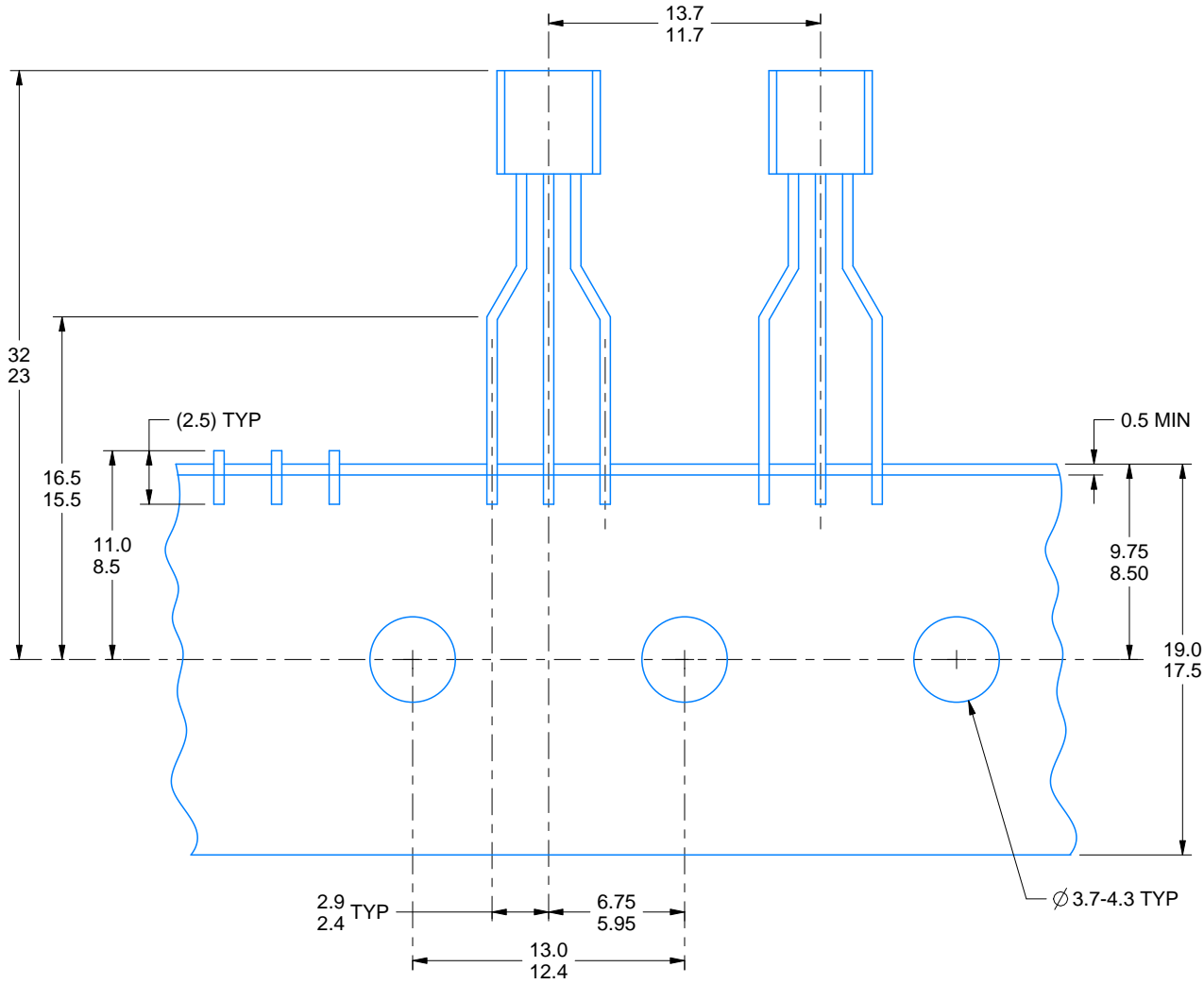

FOR FORMED LEAD OPTION PACKAGE

4215214/B 04/2017

IMPORTANT NOTICE AND DISCLAIMER

TI PROVIDES TECHNICAL AND RELIABILITY DATA (INCLUDING DATA SHEETS), DESIGN RESOURCES (INCLUDING REFERENCE DESIGNS), APPLICATION OR OTHER DESIGN ADVICE, WEB TOOLS, SAFETY INFORMATION, AND OTHER RESOURCES "AS IS" AND WITH ALL FAULTS, AND DISCLAIMS ALL WARRANTIES, EXPRESS AND IMPLIED, INCLUDING WITHOUT LIMITATION ANY IMPLIED WARRANTIES OF MERCHANTABILITY, FITNESS FOR A PARTICULAR PURPOSE OR NON-INFRINGEMENT OF THIRD PARTY INTELLECTUAL PROPERTY RIGHTS.

These resources are intended for skilled developers designing with TI products. You are solely responsible for (1) selecting the appropriate TI products for your application, (2) designing, validating and testing your application, and (3) ensuring your application meets applicable standards, and any other safety, security, regulatory or other requirements.

These resources are subject to change without notice. TI grants you permission to use these resources only for development of an application that uses the TI products described in the resource. Other reproduction and display of these resources is prohibited. No license is granted to any other TI intellectual property right or to any third party intellectual property right. TI disclaims responsibility for, and you will fully indemnify TI and its representatives against, any claims, damages, costs, losses, and liabilities arising out of your use of these resources.

TI's products are provided subject to [TI's Terms of Sale](#) or other applicable terms available either on [ti.com](https://www.ti.com) or provided in conjunction with such TI products. TI's provision of these resources does not expand or otherwise alter TI's applicable warranties or warranty disclaimers for TI products.

TI objects to and rejects any additional or different terms you may have proposed.

Mailing Address: Texas Instruments, Post Office Box 655303, Dallas, Texas 75265
Copyright © 2024, Texas Instruments Incorporated