

- **2.5-V Virtual Ground for 5-V/GND Analog Systems**
- **High Output-Current Capability Sink or Source . . . 20 mA Typ**
- **Micropower Operation . . . 170 μ A Typ**
- **Excellent Regulation Characteristics**
 - Output Regulation
 - 45 μ V Typ at $I_O = 0$ to –10 mA
 - +15 μ V Typ at $I_O = 0$ to +10 mA
 - Input Regulation = 1.5 μ V/V Typ
- **Low-Impedance Output . . . 0.0075 Ω Typ**
- **Macromodel Included**

description

In signal-conditioning applications using a single power source, a reference voltage is required for termination of all signal grounds. To accomplish this, engineers have typically used solutions consisting of resistors, capacitors, operational amplifiers, and voltage references. Texas Instruments has eliminated all of those components with one easy-to-use 3-terminal device. That device is the TLE2425 precision virtual ground.

Use of the TLE2425 over other typical circuit solutions gives the designer increased dynamic signal range, improved signal-to-noise ratio, lower distortion, improved signal accuracy, and easier interfacing to ADCs and DACs. These benefits are the result of combining a precision micropower voltage reference and a high-performance precision operational amplifier in a single silicon chip. It is the precision and performance of these two circuit functions together that yield such dramatic system-level performance.

The TLE2425 improves input regulation as well as output regulation and, in addition, reduces output impedance and power dissipation in a majority of virtual-ground-generation circuits. Both input regulation and load regulation exceed 12 bits of accuracy on a single 5-V system. Signal-conditioning front ends of data acquisition systems that push 12 bits and beyond can use the TLE2425 to eliminate a major source of system error.

OUTPUT REGULATION

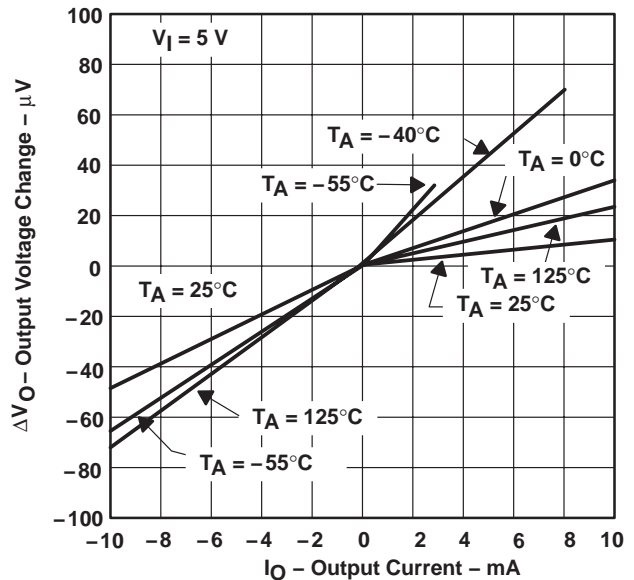

AVAILABLE OPTIONS

T _A	SMALL OUTLINE (D)	PLASTIC TO-226AA (LP)
0°C to 70°C	TLE2425CD	TLE2425CD
–40°C to 85°C	TLE2425ID	TLE2425ID
–55°C to 125°C	TLE2425MD	—

† The D package is available taped and reeled. Add R suffix to the device type (e.g., TLE2425CDR).



Please be aware that an important notice concerning availability, standard warranty, and use in critical applications of Texas Instruments semiconductor products and disclaimers thereto appears at the end of this data sheet.

PRODUCTION DATA information is current as of publication date. Products conform to specifications per the terms of Texas Instruments standard warranty. Production processing does not necessarily include testing of all parameters.



TLE2425 PRECISION VIRTUAL GROUND

SLOS065D – MARCH 1991 – REVISED APRIL 2002

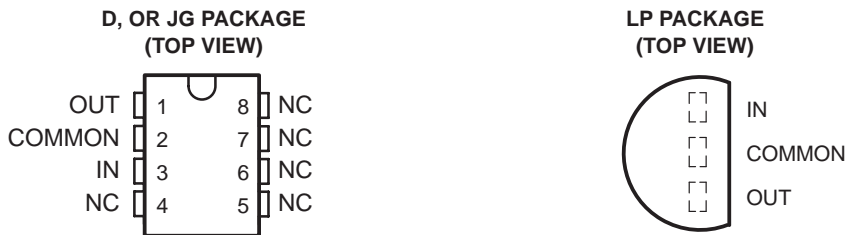

NC – No internal connection

absolute maximum ratings over operating free-air temperature range (unless otherwise noted)†

Continuous input voltage, V_I	40 V
Output current, I_O	±80 mA
Duration of short-circuit current at (or below) 25°C (see Note 1)	unlimited
Continuous total power dissipation	See Dissipation Rating Table
Operating free-air temperature range, T_A :	
C-suffix	0°C to 70°C
I-suffix	-40°C to 85°C
M-suffix	-55°C to 125°C
Storage temperature range, T_{stg}	-65°C to 150°C
Lead temperature 1,6 mm (1/16 inch) from case for 10 seconds: D package	260°C
Lead temperature 1,6 mm (1/16 inch) from case for 60 seconds: JG or LP package	300°C

† Stresses beyond those listed under “absolute maximum ratings” may cause permanent damage to the device. These are stress ratings only, and functional operation of the device at these or any other conditions beyond those indicated under “recommended operating conditions” is not implied. Exposure to absolute-maximum-rated conditions for extended periods may affect device reliability.

NOTE 1: The output may be shorted to either supply. Temperature and/or supply voltages must be limited to ensure that the maximum dissipation rating is not exceeded.

DISSIPATION RATING TABLE

PACKAGE	$T_A \leq 25^\circ\text{C}$	DERATING FACTOR	$T_A = 70^\circ\text{C}$	$T_A = 85^\circ\text{C}$	$T_A = 125^\circ\text{C}$
	POWER RATING	ABOVE $T_A = 25^\circ\text{C}$	POWER RATING	POWER RATING	POWER RATING
D	725 mW	5.8 mW/°C	464 mW	377 mW	145 mW
JG	1050 mW	8.4 mW/°C	672 mW	546 mW	210 mW
LP	775 mW	6.2 mW/°C	496 mW	403 mW	155 mW

recommended operating conditions

	C-SUFFIX		I-SUFFIX		M-SUFFIX		UNIT
	MIN	MAX	MIN	MAX	MIN	MAX	
Input voltage, V_I	4	40	4	40	4	40	V
Operating free-air temperature, T_A	0	70	-40	85	-55	125	°C



electrical characteristics at specified free-air temperature, $V_I = 5\text{ V}$, $I_O = 0$ (unless otherwise noted)

PARAMETER	TEST CONDITIONS	T_A †	TLE2425C			UNIT
			MIN	TYP	MAX	
Output voltage		25°C	2.48	2.5	2.52	V
		Full range	2.47		2.53	
Temperature coefficient of output voltage		25°C		20		ppm/°C
Bias current	$I_O = 0$	25°C		170	250	μA
		Full range			250	
Input voltage regulation	$V_I = 4.5\text{ V to }5.5\text{ V}$	25°C		1.5	20	μV
		Full range			25	
	$V_I = 4\text{ V to }40\text{ V}$	25°C		1.5	20	μV/V
		Full range			25	
Ripple rejection	$f = 120\text{ Hz}$, $\Delta V_I(\text{PP}) = 1\text{ V}$	25°C		80		dB
Output voltage regulation (source current)‡	$I_O = 0\text{ to }-10\text{ mA}$	25°C	-160	-45	160	μV
	Full range		-250		250	
Output voltage regulation (sink current)‡	$I_O = 0\text{ to }10\text{ mA}$	25°C	-160	15	160	μV
		Full range			250	
	$I_O = 0\text{ to }20\text{ mA}$	25°C	-235	65	235	
Long-term drift of output voltage	$\Delta t = 1000\text{ h}$, Noncumulative	25°C		15		ppm
Output impedance		25°C		7.5	22.5	mΩ
Short-circuit output current (sink current)	$V_O = 5\text{ V}$	25°C	30	55		mA
Short-circuit output current (source current)	$V_O = 0$		-30	-50		
Output noise voltage, rms	$f = 10\text{ Hz to }10\text{ kHz}$	25°C		100		μV
Output voltage response to output current step	$V_O\text{ to }0.1\%$, $I_O = \pm 10\text{ mA}$	25°C	$C_L = 0$		110	μs
			$C_L = 100\text{ pF}$		115	
	$V_O\text{ to }0.01\%$, $I_O = \pm 10\text{ mA}$	$C_L = 0$		180		
		$C_L = 100\text{ pF}$		180		
Output voltage response to input voltage step	$V_I = 4.5\text{ to }5.5\text{ V}$, $V_O\text{ to }0.1\%$	25°C		12	μs	
	$V_I = 4.5\text{ to }5.5\text{ V}$, $V_O\text{ to }0.01\%$			30		
Output voltage turn-on response	$V_I = 0\text{ to }5\text{ V}$, $V_O\text{ to }0.1\%$	25°C		125	μs	
	$V_I = 0\text{ to }5\text{ V}$, $V_O\text{ to }0.01\%$			210		

† Full range is 0°C to 70°C.

‡ The listed values are not production tested.

TLE2425 PRECISION VIRTUAL GROUND

SLOS065D – MARCH 1991 – REVISED APRIL 2002

electrical characteristics at specified free-air temperature, $V_I = 5\text{ V}$, $I_O = 0$ (unless otherwise noted)

PARAMETER	TEST CONDITIONS	T_A †	TLE2425I			UNIT
			MIN	TYP	MAX	
Output voltage		25°C	2.48	2.5	2.52	V
		Full range	2.47		2.53	
Temperature coefficient of output voltage		25°C	20			ppm/°C
Bias current	$I_O = 0$	25°C	170	250		μA
		Full range		250		
Input voltage regulation	$V_I = 4.5\text{ V to }5.5\text{ V}$	25°C	1.5	20		μV
		Full range		75		
	$V_I = 4\text{ V to }40\text{ V}$	25°C	1.5	20		μV/V
		Full range		75		
Ripple rejection	$f = 120\text{ Hz}$, $\Delta V_I(\text{PP}) = 1\text{ V}$	25°C	80			dB
Output voltage regulation (source current)‡	$I_O = 0\text{ to }-10\text{ mA}$	25°C	-160	-45	160	μV
	Full range		-250		250	
Output voltage regulation (sink current)‡	$I_O = 0\text{ to }-20\text{ mA}$	25°C	-450	-150	450	μV
	$I_O = 0\text{ to }8\text{ mA}$	25°C	-160	15	160	
Output voltage regulation (sink current)‡	$I_O = 0\text{ to }8\text{ mA}$	25°C	-160	15	160	μV
	Full range		-250		250	
Output voltage regulation (sink current)‡	$I_O = 0\text{ to }20\text{ mA}$	25°C	-235	65	235	μV
	Full range		-235		235	
Long-term drift of output voltage	$\Delta t = 1000\text{ h}$, Noncumulative	25°C	15			ppm
Output impedance		25°C	7.5	22.5		mΩ
Short-circuit output current (sink current)	$V_O = 5\text{ V}$	25°C	30	55		mA
Short-circuit output current (source current)	$V_O = 0$		-30	-50		
Output noise voltage, rms	$f = 10\text{ Hz to }10\text{ kHz}$	25°C	100			μV
Output voltage response to output current step	$V_O\text{ to }0.1\%$, $I_O = \pm 10\text{ mA}$	$C_L = 0$	110			μs
		$C_L = 100\text{ pF}$	115			
	$V_O\text{ to }0.01\%$, $I_O = \pm 10\text{ mA}$	$C_L = 0$	180			
		$C_L = 100\text{ pF}$	180			
Output voltage response to input voltage step	$V_I = 4.5\text{ to }5.5\text{ V}$, $V_O\text{ to }0.1\%$	25°C	12			μs
	$V_I = 4.5\text{ to }5.5\text{ V}$, $V_O\text{ to }0.01\%$		30			
Output voltage turn-on response	$V_I = 0\text{ to }5\text{ V}$, $V_O\text{ to }0.1\%$	25°C	125			μs
	$V_I = 0\text{ to }5\text{ V}$, $V_O\text{ to }0.01\%$		210			

† Full range is -40°C to 85°C.

‡ The listed values are not production tested.



electrical characteristics at specified free-air temperature, $V_I = 5\text{ V}$, $I_O = 0$ (unless otherwise noted)

PARAMETER	TEST CONDITIONS	T_A †	TLE2425M			UNIT
			MIN	TYP	MAX	
Output voltage		25°C	2.48	2.5	2.52	V
		Full range	2.47		2.53	
Temperature coefficient of output voltage		25°C	20			ppm/°C
Bias current	$I_O = 0$	25°C	170	250		μA
		Full range		250		
Input voltage regulation	$V_I = 4.5\text{ V to }5.5\text{ V}$	25°C	1.5	20		μV
		Full range		100		
	$V_I = 4.5\text{ V to }40\text{ V}$	25°C	1.5	20		μV/V
		Full range		100		
Ripple rejection	$f = 120\text{ Hz}$, $\Delta V_I(\text{PP}) = 1\text{ V}$	25°C	80			dB
Output voltage regulation (source current)‡	$I_O = 0\text{ to }-10\text{ mA}$	25°C	-160	-45	160	μV
	Full range		-250		250	
Output voltage regulation (sink current)‡	$I_O = 0\text{ to }-20\text{ mA}$	25°C	-450	-150	450	μV
	$I_O = 0\text{ to }3\text{ mA}$	25°C	-160	15	160	
Output voltage regulation (sink current)‡	$I_O = 0\text{ to }20\text{ mA}$	25°C	-235	65	235	μV
	Full range		-250		250	
Long-term drift of output voltage	$\Delta t = 1000\text{ h}$, Noncumulative	25°C	15			ppm
Output impedance		25°C	7.5	22.5		mΩ
Short-circuit output current (sink current)	$V_O = 5\text{ V}$	25°C	30	55		mA
Short-circuit output current (source current)	$V_O = 0$		-30	-50		
Output noise voltage, rms	$f = 10\text{ Hz to }10\text{ kHz}$	25°C	100			μV
Output voltage response to output current step	$V_O\text{ to }0.1\%$, $I_O = \pm 10\text{ mA}$	25°C	$C_L = 0$	110		μs
			$C_L = 100\text{ pF}$	115		
	$V_O\text{ to }0.01\%$, $I_O = \pm 10\text{ mA}$	$C_L = 0$	180			
		$C_L = 100\text{ pF}$	180			
Output voltage response to input voltage step	$V_I = 4.5\text{ to }5.5\text{ V}$, $V_O\text{ to }0.1\%$	25°C	12			μs
	$V_I = 4.5\text{ to }5.5\text{ V}$, $V_O\text{ to }0.01\%$		30			
Output voltage turn-on response	$V_I = 0\text{ to }5\text{ V}$, $V_O\text{ to }0.1\%$	25°C	125			μs
	$V_I = 0\text{ to }5\text{ V}$, $V_O\text{ to }0.01\%$		210			

† Full range is -55°C to 125°C.

‡ The listed values are not production tested.

TLE2425 PRECISION VIRTUAL GROUND

SLOS065D – MARCH 1991 – REVISED APRIL 2002

TYPICAL CHARACTERISTICS

Table Of Graphs

		FIGURE
Output voltage	Distribution	1
	vs Free-air temperature	2
Output voltage hysteresis	vs Free-air temperature	3
Input bias current	vs Input voltage	4
	vs Free-air temperature	5
Input voltage regulation		6
Ripple rejection	vs Frequency	7
Output voltage regulation		8
Output impedance	vs Frequency	9
Short-circuit output current	vs Free-air temperature	10
Spectral noise voltage density	vs Frequency	11
Wide-band noise voltage	vs Frequency	12
Output voltage change with current step	vs Time	13
Output voltage change with voltage step	vs Time	14
Output voltage power-up response	vs Time	15
Output current	vs Load capacitance	16



TYPICAL CHARACTERISTICS†

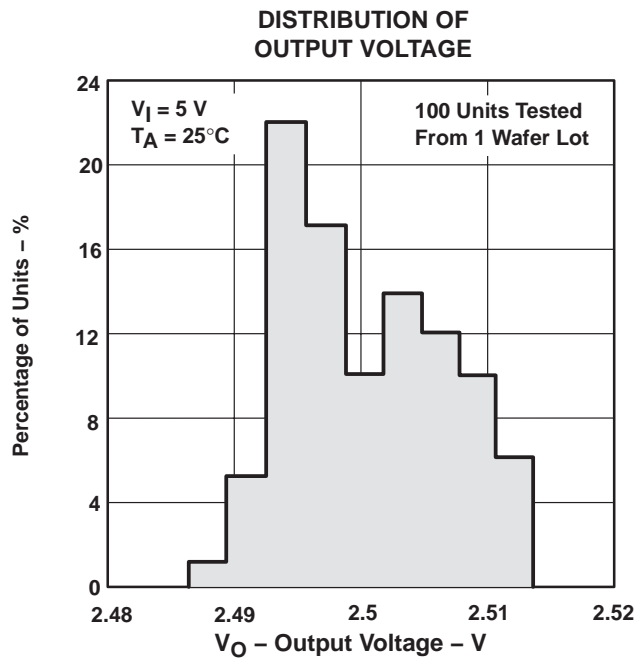

Figure 1

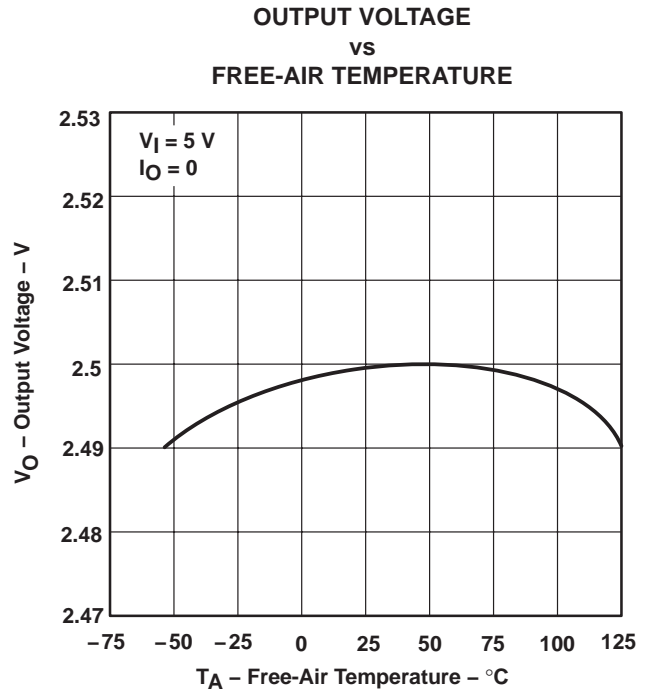

Figure 2

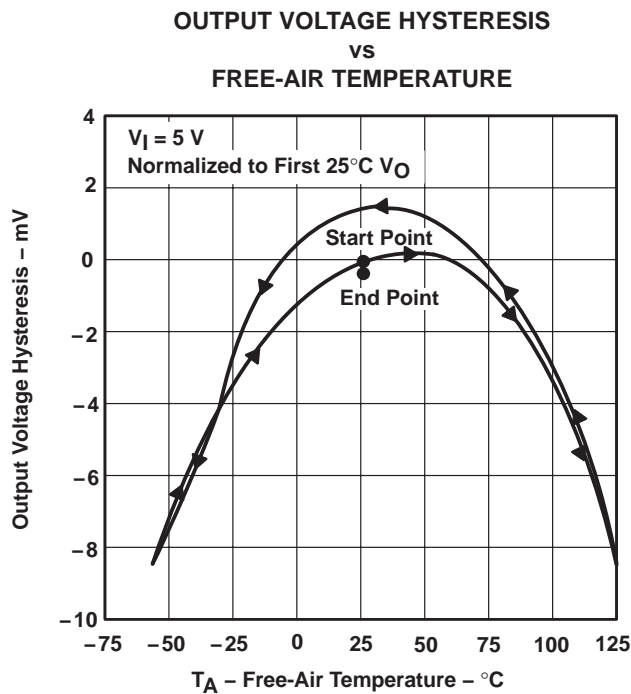

Figure 3

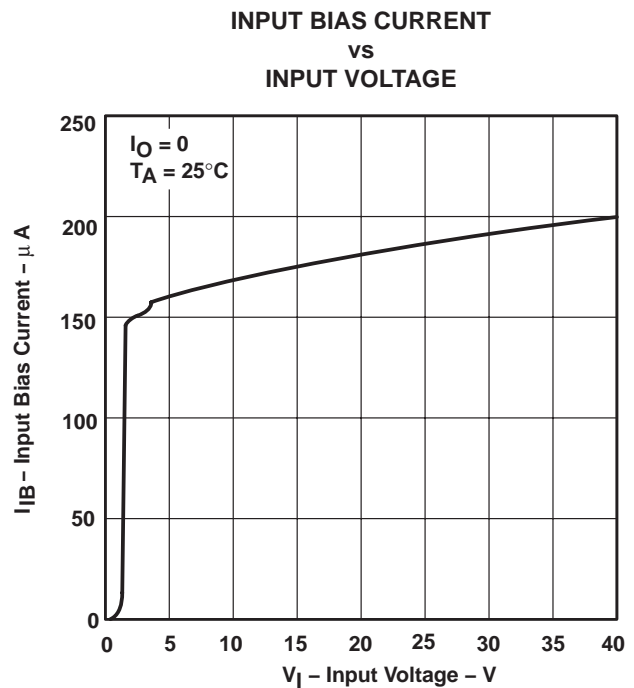

Figure 4

† Data at high and low temperatures are applicable within rated operating free-air temperature ranges of the various devices.

TLE2425 PRECISION VIRTUAL GROUND

SLOS065D – MARCH 1991 – REVISED APRIL 2002

TYPICAL CHARACTERISTICS†

**INPUT BIAS CURRENT
vs
FREE-AIR TEMPERATURE**

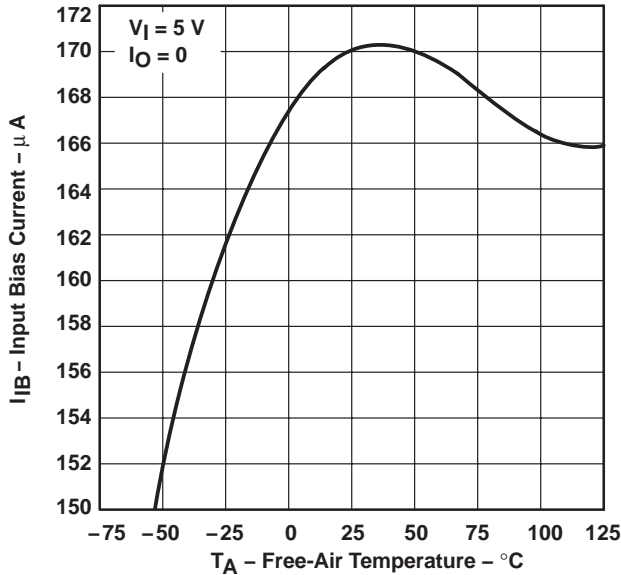

Figure 5

INPUT VOLTAGE REGULATION

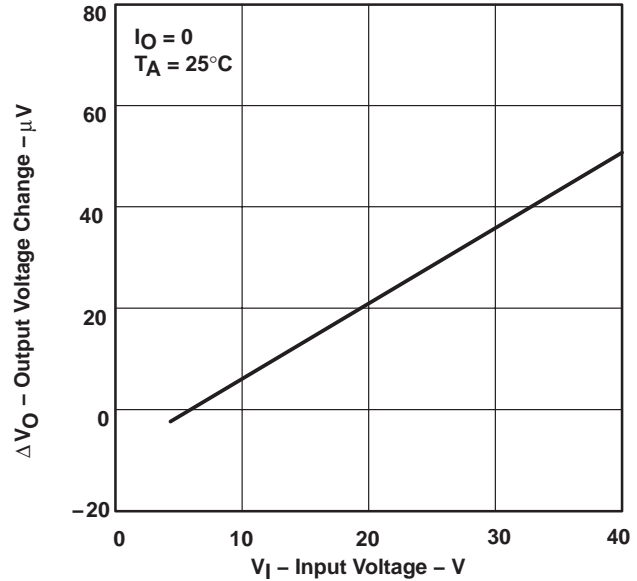

Figure 6

**RIPPLE REJECTION
vs
FREQUENCY**

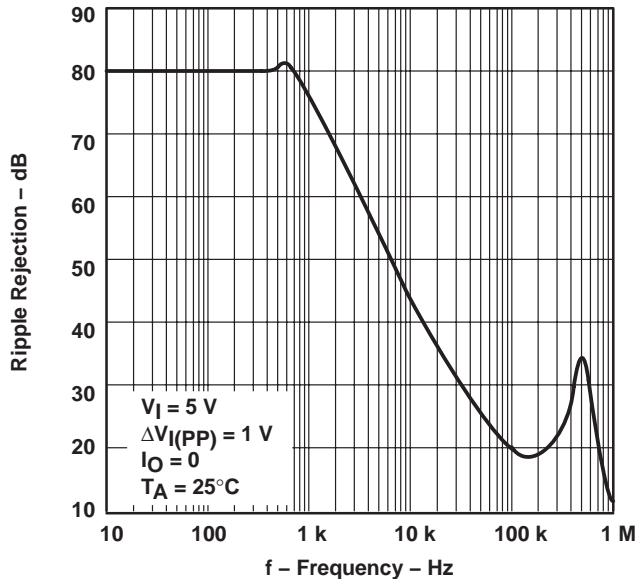

Figure 7

OUTPUT VOLTAGE REGULATION

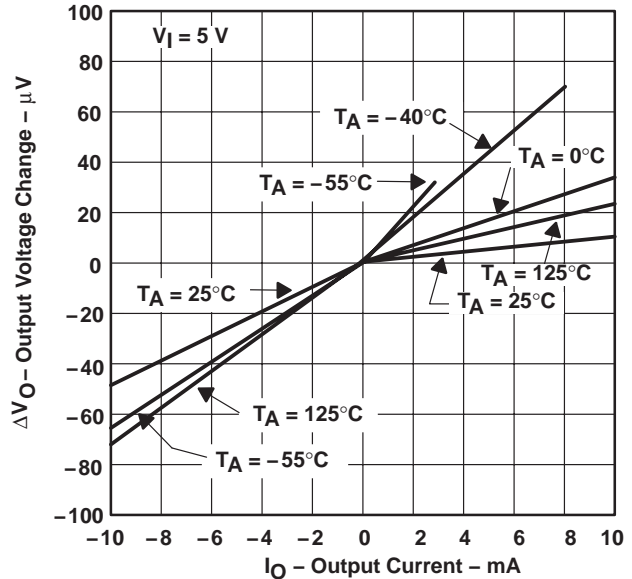

Figure 8

† Data at high and low temperatures are applicable within rated operating free-air temperature ranges of the various devices.

TYPICAL CHARACTERISTICS

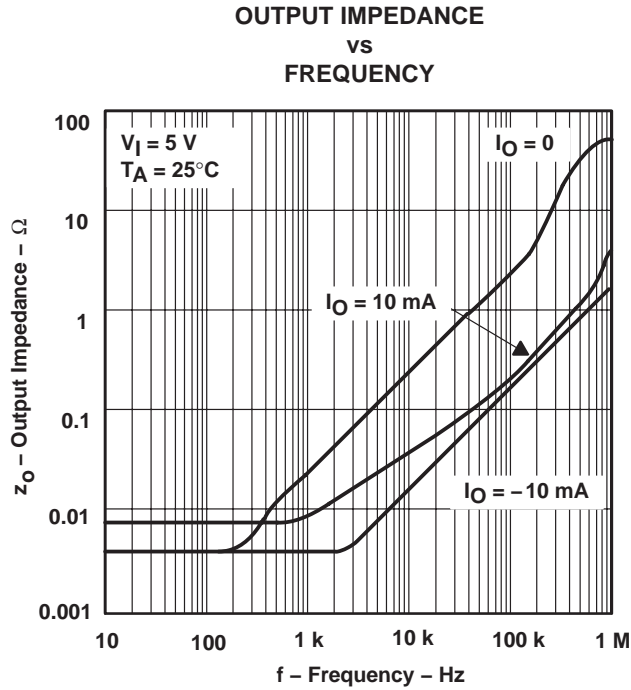

Figure 9

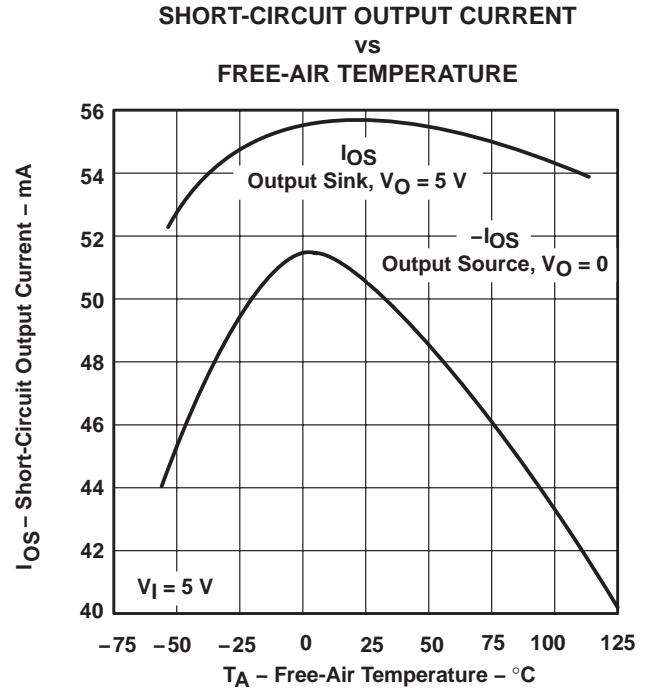

Figure 10

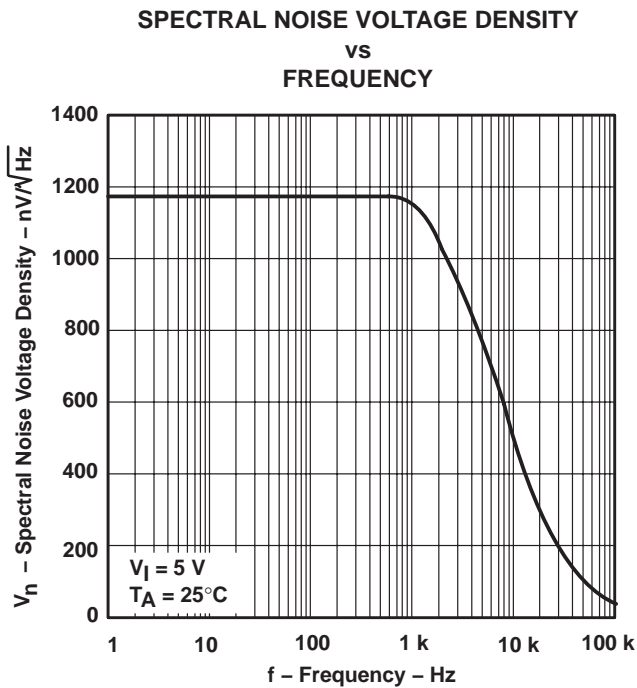

Figure 11

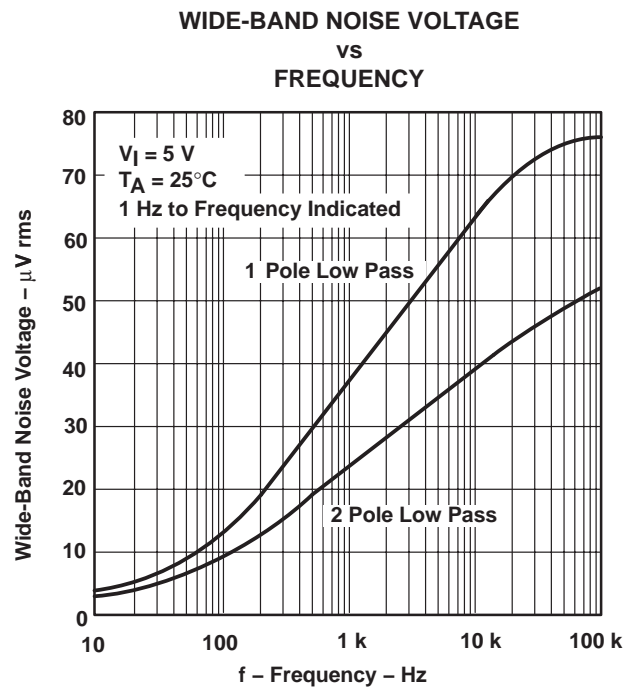

Figure 12

TYPICAL CHARACTERISTICS

OUTPUT VOLTAGE RESPONSE TO OUTPUT CURRENT STEP VS TIME

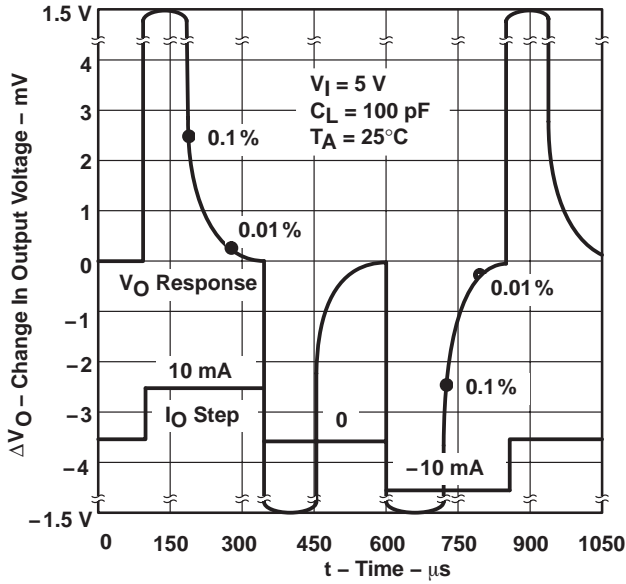

Figure 13

OUTPUT VOLTAGE RESPONSE TO INPUT VOLTAGE STEP VS TIME

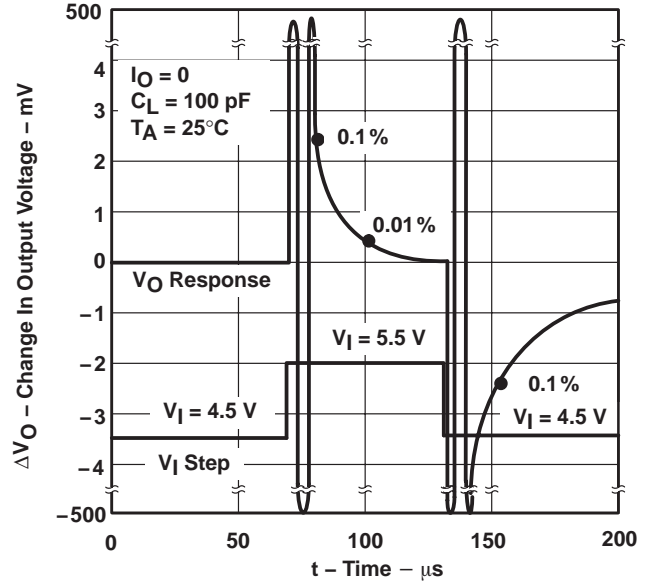

Figure 14

OUTPUT VOLTAGE POWER-UP RESPONSE VS TIME

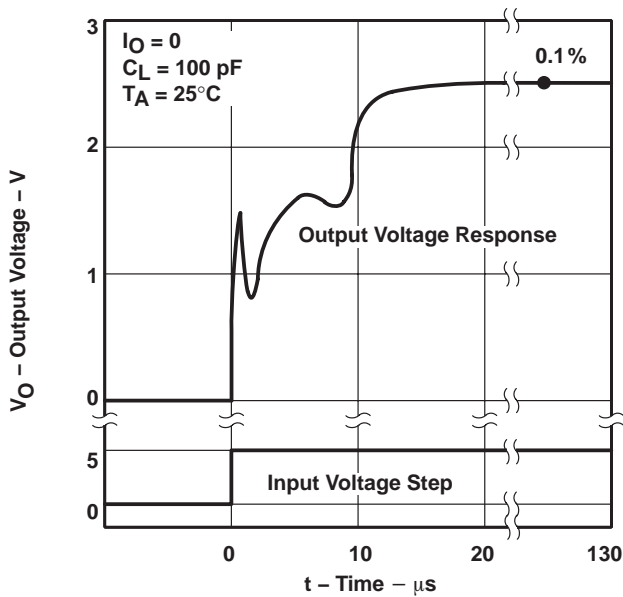

Figure 15

STABILITY RANGE OUTPUT CURRENT VS LOAD CAPACITANCE

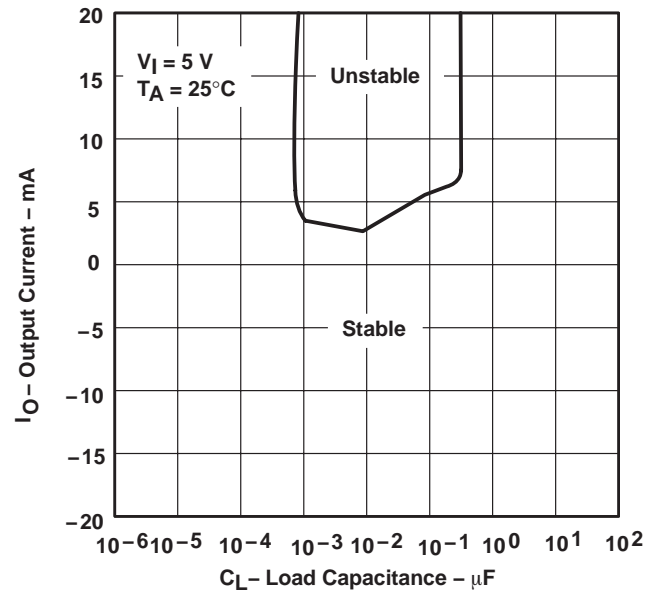

Figure 16

macromodel information

```

* TLE2425 OPERATIONAL AMPLIFIER "MACROMODEL" SUBCIRCUIT
* CREATED USING PARTS RELEASE 4.03 ON 08/21/90 AT 13:51
* REV (N/A) SUPPLY VOLTAGE: 5 V
* CONNECTIONS: INPUT
*               | COMMON
*               |   OUTPUT
*               |   |
*               |   |
*               |   |
.SUBCKT TLE2425 3 4 5
*

```

```

* OPAMP SECTION
C1      11 12 21.66E-12
C2      6 7 30.00E-12
C3      87 0 10.64E-9
CPSR    85 86 15.9E-9
DCM+    81 82 DX
DCM-    83 81 DX
DC      5 53 DX
DE      54 5 DX
DLN     92 90 DX
DLP     90 91 DX
DP      4 3 DX
ECMR    84 99 (2,99) 1
EGND    99 0 POLY(2) (3,0) (4,0) 0 .5 .5
EPSR    85 0 POLY(1) (3,4) -16.22E-6 3.24E-6
ENSE    89 2 POLY(1) (88,0) 120E-6 1
FB      7 99 POLY(6) VB VC VE VLP VLN VPSR 0 74.8E6 -10E6 10E6 10E6
+ -10E6 74E6
GA      6 0 11 12 320.4E-6
GCM     0 6 10 99 1.013E-9
GPSR    85 86 (85,86) 100E-6
GRC1    4 11 (4,11) 3.204E-4
GRC2    4 12 (4,12) 3.204E-4
GRE1    13 10 (13,10) 1.038E-3
GRE2    14 10 (14,10) 1.038E-3
HLIM    90 0 VLIM 1K
HCMR    80 1 POLY(2) VCM+ VCM- 0 1E2 1E2
IRP     3 4 146E-6
IEE     3 10 DC 24.05E-6
IIO     2 0 .2E-9
I1      88 0 1E-21
Q1      11 89 13 QX
Q2      12 80 14 QX
R2      6 9 100.0E3
RCM     84 81 1K
REE     10 99 8.316E6
RN1     87 0 2.55E8
RN2     87 88 11.67E3

```

TLE2425 PRECISION VIRTUAL GROUND

SLOS065D – MARCH 1991 – REVISED APRIL 2002

macromodel information (continued)

```
RO1      8  5  63
RO2      7 99  62
VCM+    82 99  1.0
VCM-    83 99 -2.3
VB       9  0  DC  0
VC       3 53  DC  1.400
VE      54  4  DC  1.400
VLIM     7  8  DC  0
VLP     91  0  DC  30
VLN      0 92  DC  30
VPSR     0 86  DC  0
RFB      5  2  1K
RIN     30  1  1K
RCOM    34  4  .1
*REGULATOR SECTION
RG1     30  0  20MEG
RG2     30 31  .2
RG3     31 35  400K
RG4     35 34  411K
RG5     31 36  25MEG
HREG    31 32  POLY(2)  VPSET VNSET  0  1E2 1E2
VREG    32 33  DC  0V
EREG    33 34  POLY(1)  (36,34)  1.23  1
VADJ    36 34  1.27V
HPSET   37  0  VREG  1.030E3
VPSET   38  0  DC  20V
HNSET   39  0  VREG  6.11E5
VNSET   40  0  DC -20V
DSUB    4  34  DX
DPOS    37 38  DX
DNNEG   40 39  DX
.MODEL DX D(IS=800.0E-18)
.MODEL QX PNP(IS=800.0E-18 BF=480)
.ENDS
```

PACKAGING INFORMATION

Orderable Device	Status (1)	Package Type	Package Drawing	Pins	Package Qty	Eco Plan (2)	Lead finish/ Ball material (6)	MSL Peak Temp (3)	Op Temp (°C)	Device Marking (4/5)	Samples
TLE2425CD	ACTIVE	SOIC	D	8	75	RoHS & Green	NIPDAU	Level-1-260C-UNLIM		2425C	Samples
TLE2425CDR	ACTIVE	SOIC	D	8	2500	RoHS & Green	NIPDAU	Level-1-260C-UNLIM		2425C	Samples
TLE2425CLP	ACTIVE	TO-92	LP	3	1000	RoHS & Green	SN	N / A for Pkg Type		2425C	Samples
TLE2425CPS	ACTIVE	SO	PS	8	80	RoHS & Green	NIPDAU	Level-1-260C-UNLIM		Q2425	Samples
TLE2425CPSR	ACTIVE	SO	PS	8	2000	RoHS & Green	NIPDAU	Level-1-260C-UNLIM		Q2425	Samples
TLE2425ID	ACTIVE	SOIC	D	8	75	RoHS & Green	NIPDAU	Level-1-260C-UNLIM		2425I	Samples
TLE2425IDG4	ACTIVE	SOIC	D	8	75	RoHS & Green	NIPDAU	Level-1-260C-UNLIM		2425I	Samples
TLE2425IDR	ACTIVE	SOIC	D	8	2500	RoHS & Green	NIPDAU	Level-1-260C-UNLIM		2425I	Samples
TLE2425IDRG4	ACTIVE	SOIC	D	8	2500	RoHS & Green	NIPDAU	Level-1-260C-UNLIM		2425I	Samples
TLE2425ILP	ACTIVE	TO-92	LP	3	1000	RoHS & Green	SN	N / A for Pkg Type		2425I	Samples
TLE2425MD	ACTIVE	SOIC	D	8	75	RoHS & Green	NIPDAU	Level-1-260C-UNLIM	-55 to 125	2425M	Samples
TLE2425MDRG4	ACTIVE	SOIC	D	8	2500	RoHS & Green	NIPDAU	Level-1-260C-UNLIM	-55 to 125	2425M	Samples

(1) The marketing status values are defined as follows:

ACTIVE: Product device recommended for new designs.

LIFEBUY: TI has announced that the device will be discontinued, and a lifetime-buy period is in effect.

NRND: Not recommended for new designs. Device is in production to support existing customers, but TI does not recommend using this part in a new design.

PREVIEW: Device has been announced but is not in production. Samples may or may not be available.

OBSOLETE: TI has discontinued the production of the device.

(2) **RoHS:** TI defines "RoHS" to mean semiconductor products that are compliant with the current EU RoHS requirements for all 10 RoHS substances, including the requirement that RoHS substance do not exceed 0.1% by weight in homogeneous materials. Where designed to be soldered at high temperatures, "RoHS" products are suitable for use in specified lead-free processes. TI may reference these types of products as "Pb-Free".

RoHS Exempt: TI defines "RoHS Exempt" to mean products that contain lead but are compliant with EU RoHS pursuant to a specific EU RoHS exemption.

Green: TI defines "Green" to mean the content of Chlorine (Cl) and Bromine (Br) based flame retardants meet JS709B low halogen requirements of <=1000ppm threshold. Antimony trioxide based flame retardants must also meet the <=1000ppm threshold requirement.

- (3) MSL, Peak Temp. - The Moisture Sensitivity Level rating according to the JEDEC industry standard classifications, and peak solder temperature.
- (4) There may be additional marking, which relates to the logo, the lot trace code information, or the environmental category on the device.
- (5) Multiple Device Markings will be inside parentheses. Only one Device Marking contained in parentheses and separated by a "~" will appear on a device. If a line is indented then it is a continuation of the previous line and the two combined represent the entire Device Marking for that device.
- (6) Lead finish/Ball material - Orderable Devices may have multiple material finish options. Finish options are separated by a vertical ruled line. Lead finish/Ball material values may wrap to two lines if the finish value exceeds the maximum column width.

Important Information and Disclaimer:The information provided on this page represents TI's knowledge and belief as of the date that it is provided. TI bases its knowledge and belief on information provided by third parties, and makes no representation or warranty as to the accuracy of such information. Efforts are underway to better integrate information from third parties. TI has taken and continues to take reasonable steps to provide representative and accurate information but may not have conducted destructive testing or chemical analysis on incoming materials and chemicals. TI and TI suppliers consider certain information to be proprietary, and thus CAS numbers and other limited information may not be available for release.

In no event shall TI's liability arising out of such information exceed the total purchase price of the TI part(s) at issue in this document sold by TI to Customer on an annual basis.

TAPE AND REEL INFORMATION

QUADRANT ASSIGNMENTS FOR PIN 1 ORIENTATION IN TAPE

*All dimensions are nominal

Device	Package Type	Package Drawing	Pins	SPQ	Reel Diameter (mm)	Reel Width W1 (mm)	A0 (mm)	B0 (mm)	K0 (mm)	P1 (mm)	W (mm)	Pin1 Quadrant
TLE2425CDR	SOIC	D	8	2500	330.0	12.4	6.4	5.2	2.1	8.0	12.0	Q1
TLE2425CPSR	SO	PS	8	2000	330.0	16.4	8.35	6.6	2.4	12.0	16.0	Q1
TLE2425IDR	SOIC	D	8	2500	330.0	12.4	6.4	5.2	2.1	8.0	12.0	Q1

TAPE AND REEL BOX DIMENSIONS

*All dimensions are nominal

Device	Package Type	Package Drawing	Pins	SPQ	Length (mm)	Width (mm)	Height (mm)
TLE2425CDR	SOIC	D	8	2500	350.0	350.0	43.0
TLE2425CPSR	SO	PS	8	2000	853.0	449.0	35.0
TLE2425IDR	SOIC	D	8	2500	350.0	350.0	43.0

TUBE

*All dimensions are nominal

Device	Package Name	Package Type	Pins	SPQ	L (mm)	W (mm)	T (μm)	B (mm)
TLE2425CD	D	SOIC	8	75	505.46	6.76	3810	4
TLE2425CPS	PS	SOP	8	80	530	10.5	4000	4.1
TLE2425ID	D	SOIC	8	75	505.46	6.76	3810	4
TLE2425IDG4	D	SOIC	8	75	505.46	6.76	3810	4
TLE2425MD	D	SOIC	8	75	505.46	6.76	3810	4



D0008A

PACKAGE OUTLINE

SOIC - 1.75 mm max height

SMALL OUTLINE INTEGRATED CIRCUIT



4214825/C 02/2019

NOTES:

- Linear dimensions are in inches [millimeters]. Dimensions in parenthesis are for reference only. Controlling dimensions are in inches. Dimensioning and tolerancing per ASME Y14.5M.
- This drawing is subject to change without notice.
- This dimension does not include mold flash, protrusions, or gate burrs. Mold flash, protrusions, or gate burrs shall not exceed $.006$ [0.15] per side.
- This dimension does not include interlead flash.
- Reference JEDEC registration MS-012, variation AA.

EXAMPLE BOARD LAYOUT

D0008A

SOIC - 1.75 mm max height

SMALL OUTLINE INTEGRATED CIRCUIT



LAND PATTERN EXAMPLE
 EXPOSED METAL SHOWN
 SCALE:8X



SOLDER MASK DETAILS

4214825/C 02/2019

NOTES: (continued)

- 6. Publication IPC-7351 may have alternate designs.
- 7. Solder mask tolerances between and around signal pads can vary based on board fabrication site.

EXAMPLE STENCIL DESIGN

D0008A

SOIC - 1.75 mm max height

SMALL OUTLINE INTEGRATED CIRCUIT



SOLDER PASTE EXAMPLE
BASED ON .005 INCH [0.125 MM] THICK STENCIL
SCALE:8X

4214825/C 02/2019

NOTES: (continued)

8. Laser cutting apertures with trapezoidal walls and rounded corners may offer better paste release. IPC-7525 may have alternate design recommendations.
9. Board assembly site may have different recommendations for stencil design.

MECHANICAL DATA

PS (R-PDSO-G8)

PLASTIC SMALL-OUTLINE PACKAGE



- NOTES:
- A. All linear dimensions are in millimeters.
 - B. This drawing is subject to change without notice.
 - C. Body dimensions do not include mold flash or protrusion, not to exceed 0,15.

GENERIC PACKAGE VIEW

LP 3

TO-92 - 5.34 mm max height

TRANSISTOR OUTLINE



Images above are just a representation of the package family, actual package may vary.
Refer to the product data sheet for package details.

4040001-2/F

LP0003A



PACKAGE OUTLINE

TO-92 - 5.34 mm max height

TO-92



4215214/B 04/2017

NOTES:

1. All linear dimensions are in millimeters. Any dimensions in parenthesis are for reference only. Dimensioning and tolerancing per ASME Y14.5M.
2. This drawing is subject to change without notice.
3. Lead dimensions are not controlled within this area.
4. Reference JEDEC TO-226, variation AA.
5. Shipping method:
 - a. Straight lead option available in bulk pack only.
 - b. Formed lead option available in tape and reel or ammo pack.
 - c. Specific products can be offered in limited combinations of shipping medium and lead options.
 - d. Consult product folder for more information on available options.

EXAMPLE BOARD LAYOUT

LP0003A

TO-92 - 5.34 mm max height

TO-92

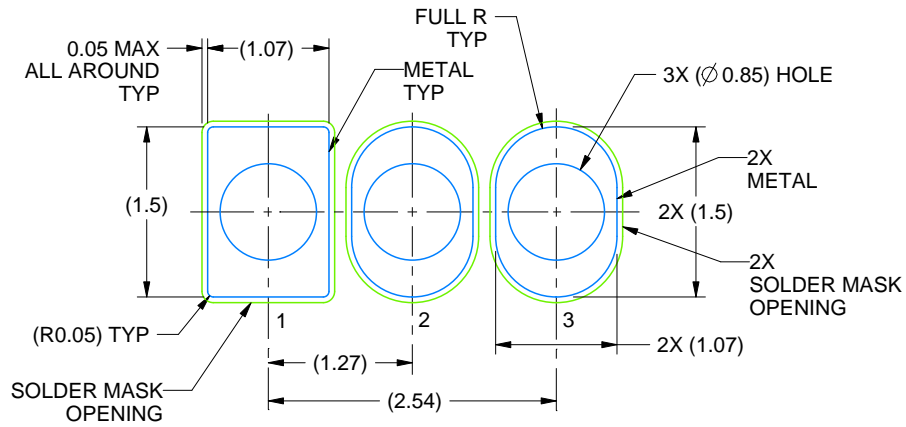

LAND PATTERN EXAMPLE
STRAIGHT LEAD OPTION
NON-SOLDER MASK DEFINED
SCALE:15X



LAND PATTERN EXAMPLE
FORMED LEAD OPTION
NON-SOLDER MASK DEFINED
SCALE:15X

4215214/B 04/2017

TAPE SPECIFICATIONS

LP0003A

TO-92 - 5.34 mm max height

TO-92



FOR FORMED LEAD OPTION PACKAGE

4215214/B 04/2017

IMPORTANT NOTICE AND DISCLAIMER

TI PROVIDES TECHNICAL AND RELIABILITY DATA (INCLUDING DATA SHEETS), DESIGN RESOURCES (INCLUDING REFERENCE DESIGNS), APPLICATION OR OTHER DESIGN ADVICE, WEB TOOLS, SAFETY INFORMATION, AND OTHER RESOURCES "AS IS" AND WITH ALL FAULTS, AND DISCLAIMS ALL WARRANTIES, EXPRESS AND IMPLIED, INCLUDING WITHOUT LIMITATION ANY IMPLIED WARRANTIES OF MERCHANTABILITY, FITNESS FOR A PARTICULAR PURPOSE OR NON-INFRINGEMENT OF THIRD PARTY INTELLECTUAL PROPERTY RIGHTS.

These resources are intended for skilled developers designing with TI products. You are solely responsible for (1) selecting the appropriate TI products for your application, (2) designing, validating and testing your application, and (3) ensuring your application meets applicable standards, and any other safety, security, regulatory or other requirements.

These resources are subject to change without notice. TI grants you permission to use these resources only for development of an application that uses the TI products described in the resource. Other reproduction and display of these resources is prohibited. No license is granted to any other TI intellectual property right or to any third party intellectual property right. TI disclaims responsibility for, and you will fully indemnify TI and its representatives against, any claims, damages, costs, losses, and liabilities arising out of your use of these resources.

TI's products are provided subject to [TI's Terms of Sale](#) or other applicable terms available either on ti.com or provided in conjunction with such TI products. TI's provision of these resources does not expand or otherwise alter TI's applicable warranties or warranty disclaimers for TI products.

TI objects to and rejects any additional or different terms you may have proposed.

Mailing Address: Texas Instruments, Post Office Box 655303, Dallas, Texas 75265
Copyright © 2022, Texas Instruments Incorporated