

- RF SAW Filter, 2332.5 MHz, 25.6 MHz Bandwidth
- 3.0 x 3.0 x 1.4 mm Surface-mount Case
- Input/Output Impedance 50Ω/50Ω
- AEC-Q200 Qualified
- Moisture Sensitivity Level: 1
- Complies with Directive 2002/95/EC (RoHS)

RoHS  
Compliant

SF1224E-1

2332.5 MHz  
SAW Filter

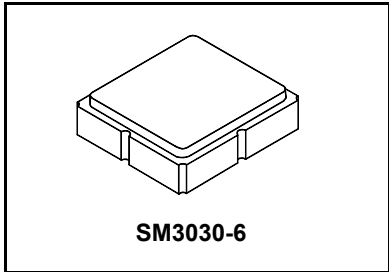

**Absolute Maximum Ratings**

Rating	Value	Units
Incident Power in Passband	+15	dBm
Incident Power Out of Band	+27	dBm
DC Voltage on any Non-ground Terminal	3	VDC
Operating Temperature Range	-40 to +105	°C
Component Storage Temperature Range	-40 to +105	°C
Storage Temperature Range in Tape and Reel	-40 to +85	°C
Maximum Soldering Profile, 5 cycles/10 seconds maximum	265	°C

**Electrical Characteristics**

Characteristic	Sym	Notes	Min	Typ	Max	Units
Center Frequency	$f_c$			2332.5		MHz
Maximum Insertion Loss, 2319.4 to 2345.0 MHz	IL			1.5	2.5	dB
Amplitude Ripple, p-p, 2319.4 to 2345.0 MHz				0.7	1.2	
I/O Return Loss, 2319.4 to 2345.0 MHz			10	12		
I/O VSWR, 2319.4 to 2345.0 MHz				1.7:1	2.2:1	
Attenuation (Reference level from 0 dB)						dB
10 to 2224 MHz			30	38		
2453 to 2600 MHz			35	42		
2600 to 3000 MHz			30	35		
3000 to 6000 MHz			15	18		
Terminating Source impedance	$Z_s$			50		Ω
Terminating Load impedance	$Z_L$			50		Ω

Single Ended Input / Output, Impedance match	No matching network required for operation at 50 ohms
Case Style	SM3030-6
Lid Symbolization: Y = Year, WW = Week, S = Shift)	A65, <u>Y</u> WWS

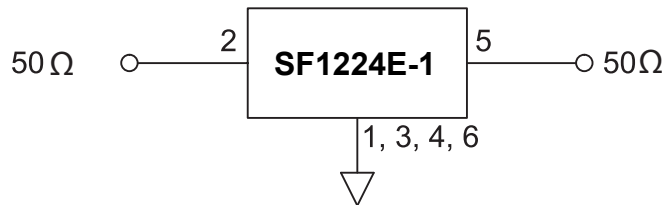

 **CAUTION: Electrostatic Sensitive Device. Observe precautions for handling.**  
**NOTES:**

1. The design, manufacturing process, and specifications of this device are subject to change.
2. US or International patents may apply.
3. RoHS compliant from the first date of manufacture.

# Filter Response Plots

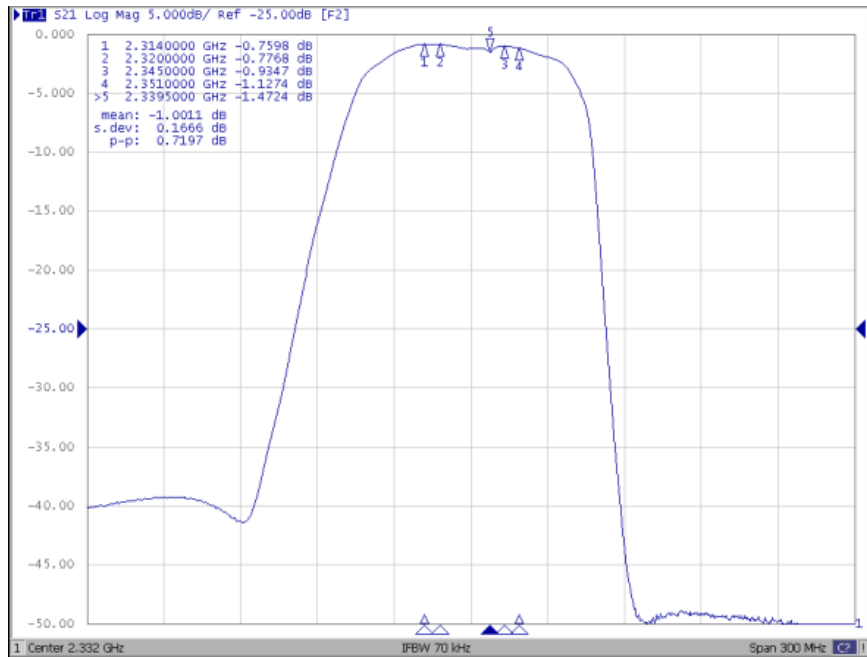
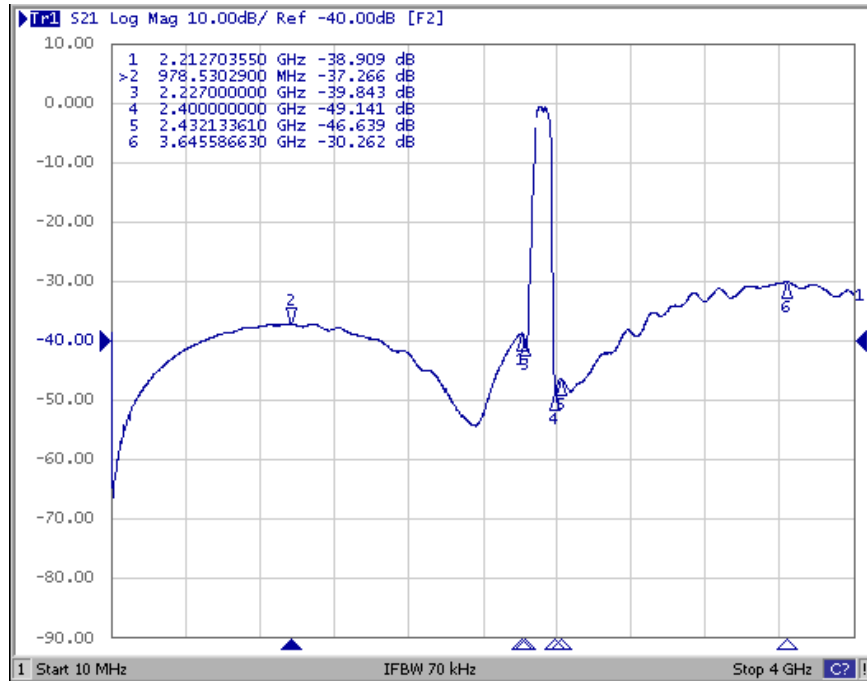

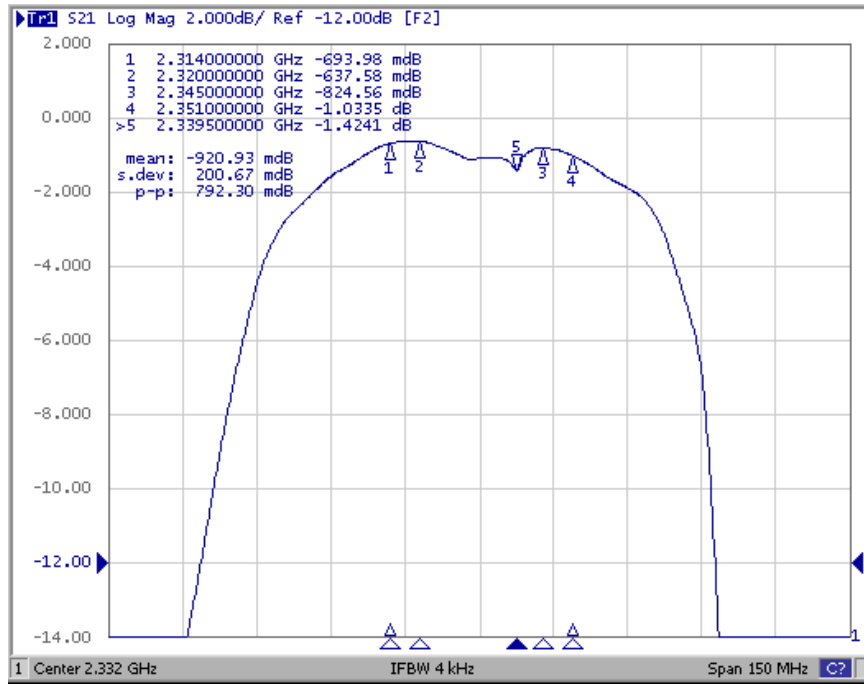

## Input/Output VSWR Plots

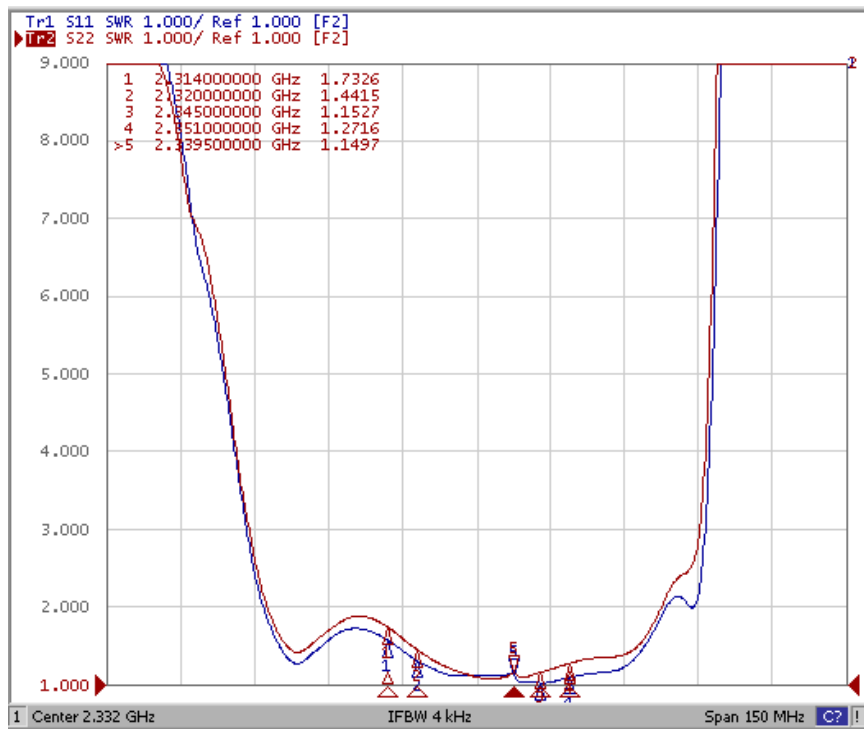

## 6-Terminal Ceramic Surface-Mount Case 3.0 X 3.0 mm Nominal Footprint

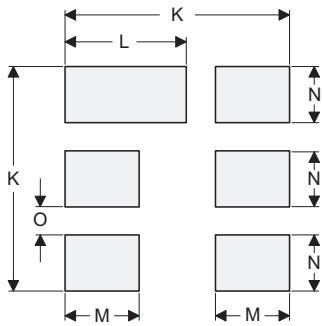
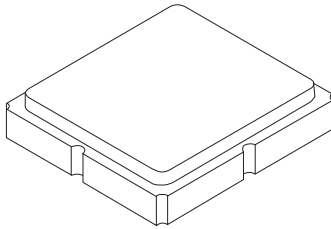

**PCB Footprint Top View**

### Case and PCB Footprint Dimensions

Dimension	mm			Inches		
	Min	Nom	Max	Min	Nom	Max
<b>A</b>	2.87	3.00	3.13	0.113	0.118	0.123
<b>B</b>	2.87	3.00	3.13	0.113	0.118	0.123
<b>C</b>	1.12	1.25	1.38	0.044	0.049	0.054
<b>D</b>	0.77	0.90	1.03	0.030	0.035	0.040
<b>E</b>	2.67	2.80	2.93	0.105	0.110	0.115
<b>F</b>	1.47	1.60	1.73	0.058	0.063	0.068
<b>G</b>	0.72	0.85	0.98	0.028	0.033	0.038
<b>H</b>	1.37	1.50	1.63	0.054	0.059	0.064
<b>I</b>	0.47	0.60	0.73	0.019	0.024	0.029
<b>J</b>	1.17	1.30	1.43	0.046	0.051	0.056
<b>K</b>		3.20			0.126	
<b>L</b>		1.70			0.067	
<b>M</b>		1.05			0.041	
<b>N</b>		0.81			0.032	
<b>O</b>		0.38			0.015	

### Case Materials

Materials	
Solder Pad Plating	0.3 to 1.0 $\mu\text{m}$ Gold over 1.27 to 8.89 $\mu\text{m}$ Nickel
Lid Plating	2.0 to 3.0 $\mu\text{m}$ Nickel
Body	$\text{Al}_2\text{O}_3$ Ceramic

### TOP VIEW

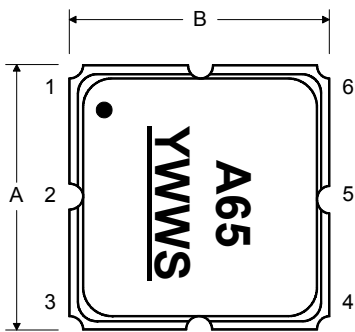

### BOTTOM VIEW

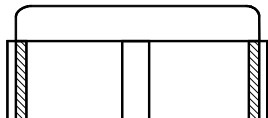
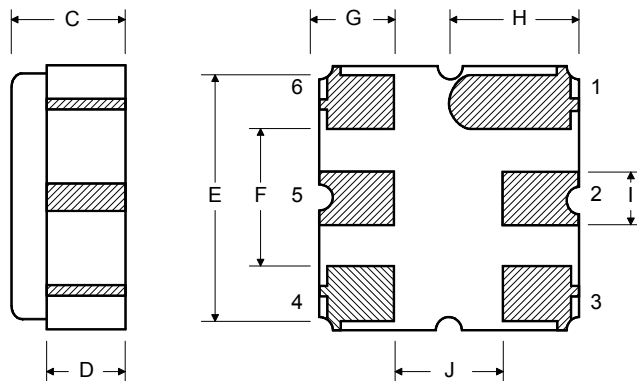

## Tape and Reel Specifications

Tape and Reel Standard per ANSI/EIA-481

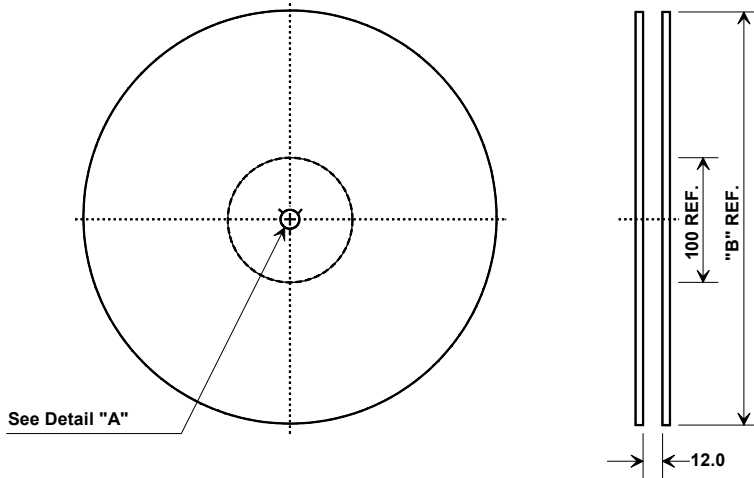

"B"		Quantity Per Reel
Inches	millimeters	
7	178	500
13	330	3000

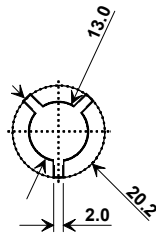

### COMPONENT ORIENTATION and DIMENSIONS

Carrier Tape Dimensions	
Ao	3.35 mm
Bo	3.35 mm
Ko	1.40 mm
Pitch	8.0 mm
W	12.0 mm

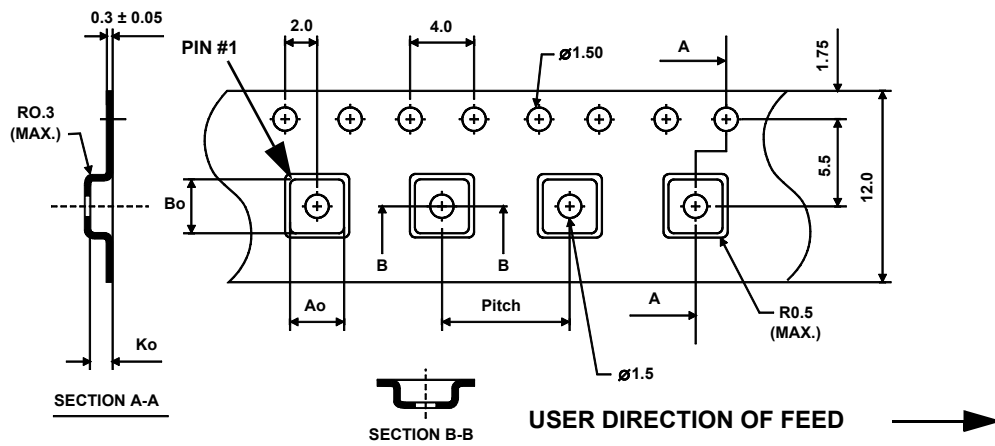

## Recommended Reflow Profile

1. Preheating shall be fixed at 150~180°C for 60~90 seconds.
2. Ascending time to preheating temperature 150°C shall be 30 seconds min.
3. Heating shall be fixed at 220°C for 50~80 seconds and at 260°C+0/-5°C peak (10 seconds).
4. Time: 5 times maximum.

