

- **Low-loss RF SAW Filter**
- **3 x 3 mm Surface-mount Package**
- **Complies with Directive 2002/95/EC (RoHS)**
- **Simple external impedance matching**
- **Moisture Sensitivity Level: 1**
- **AEC-Q200 Qualified**

RoHS
Compliant

RF3624E

314.45 MHz
SAW Filter

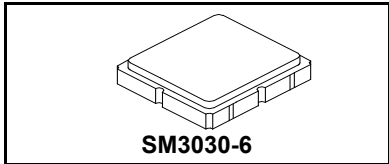

Absolute Maximum Ratings

Rating	Value	Units
Input Power Level	+13	dBm
DC Voltage on any Non-ground Terminal	±0	V
Operating Temperature Range	-40 to +105	°C
Storage Temperature Range in Tape and Reel	-40 to +105	°C

Electrical Characteristics

Characteristic	Sym	Notes	Min	Typ	Max	Units
Center Frequency	f_C			314.45		MHz
Minimum Insertion Loss, α min	IL					dB
Incl. Loss in Matching Elements		313.92 to 314.98 MHz		1.9	2.7	
Excl. Loss In Matching Elements		313.92 to 314.98 MHz		1.0	1.6	
Pass Band (Relative to α min)		313.92 to 314.98 MHz		2.2	3.0	
		313.90 to 315.00 MHz		2.7	3.4	
Relative Attenuation (Relative to α min)						dB
10 to 180 MHz			61	66		
180 to 200 MHz			57	62		
300 to 310 MHz			26	31		
310 to 313 MHz			11	16		
315.9 to 318.8 MHz			11	16		
318.9 to 326 MHz			18	25		
326 to 328 MHz			31	36		
328 to 340 MHz			36	41		
340 to 389 MHz			41	46		
389 to 568 MHz			54	59		
568 to 1164 MHz			61	66		
1164 to 2250 MHz			51	57		
2250 to 2500 MHz			55	61		
Input: Z_{IN} = Ls1/Cp1				130/8.2		nH/pF
Output: Z_{OUT} = Ls2/Cp2				120/5.6		
Terminating Source Impedance (single)	Z_S			50		Ω
Terminating Load Impedance (single)	Z_L			50		

Case Style	SM3030-6 3.0 x 3.0 mm Nominal Footprint		
Lid Symbolization (Y=year, WW=week, S=shift) dot=pin 1 indicator	5J, <u>Y</u> WWS		
Standard Reel Quantity	Reel Size 7 Inch	500 Pieces/Reel	
	Reel Size 13 Inch	3000 Pieces/Reel	

CAUTION: Electrostatic Sensitive Device. Observe precautions for handling.
NOTES:

1. The design, manufacturing process, and specifications of this device are subject to change.
2. US or International patents may apply.
3. RoHS compliant from the first date of manufacture.

Electrical Connections

Connection	Terminals
Input/Input Return	1
Input Return/Input	2
Output Return/Output	4
Output/Output Return	5
Ground	3, 6

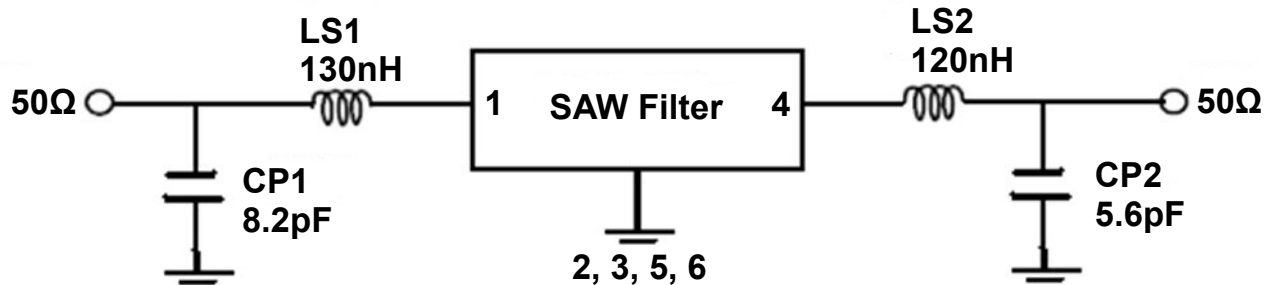

LS1 = Murata LQW18ANR13G00

LS2 = Murata LQW18ANR12G00

CP1 = Murata GRM1555C1H8R2DA01

CP2 = Murata GRM1555C1H5R6DA01

RF3624E Frequency Characteristics

S21 Response: span 200 MHz

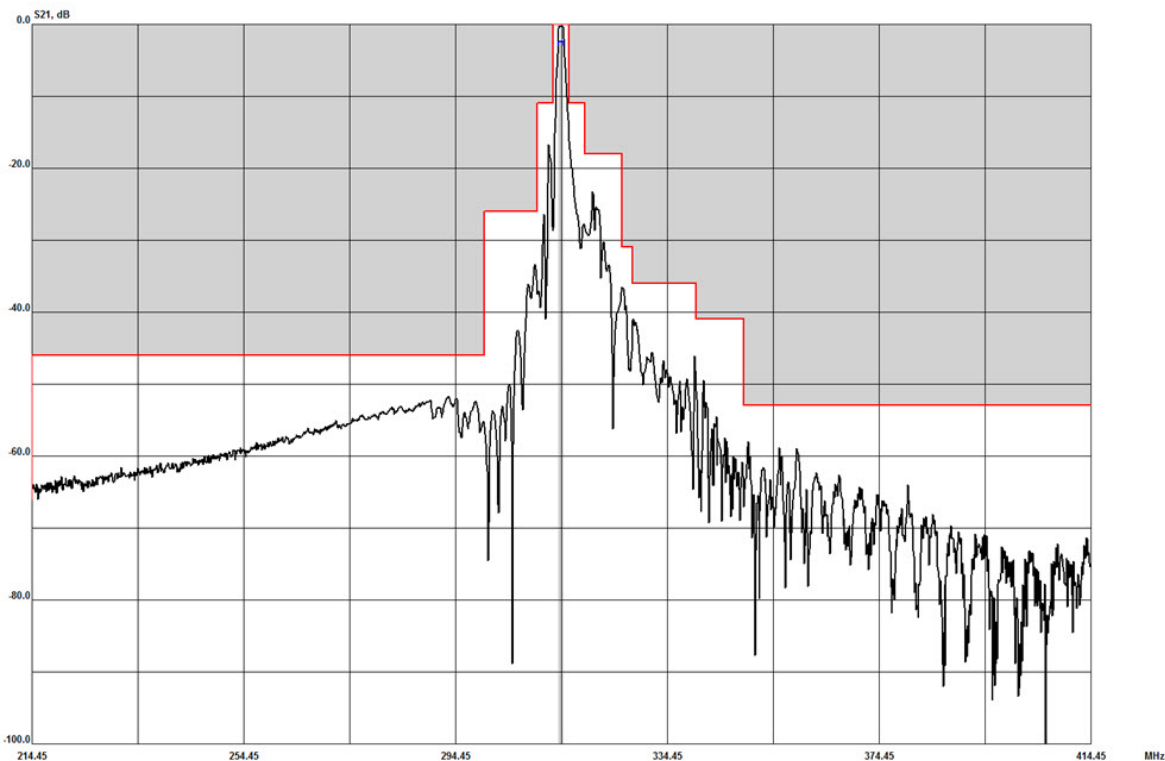

RF3624E Frequency Characteristics (continued)

S21 Response: span 2 MHz

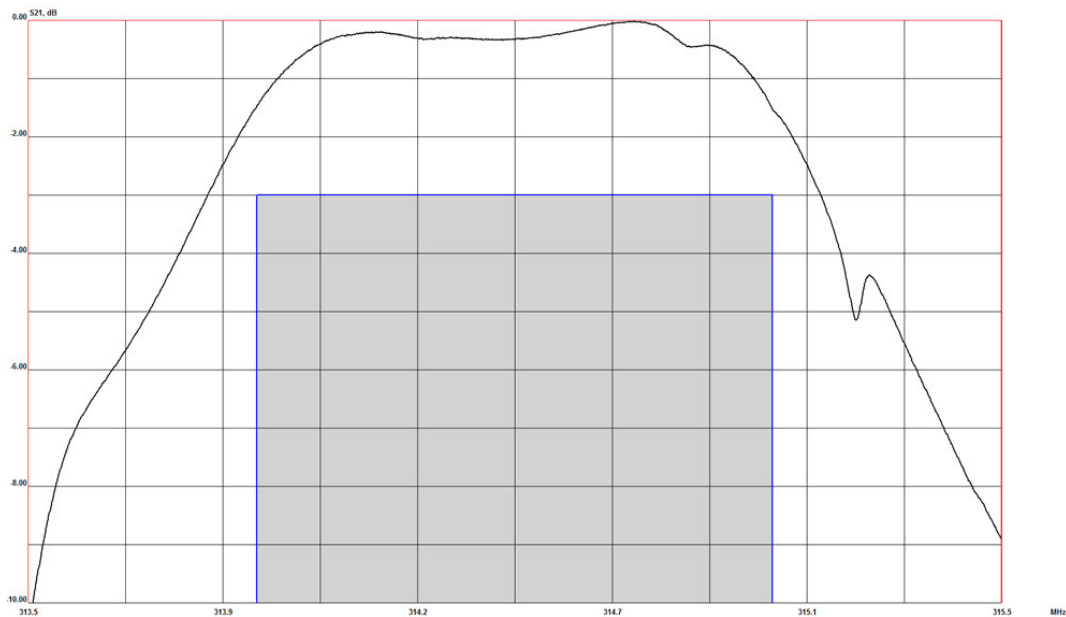

S21 Response: span 10 MHz to 2.5 GHz

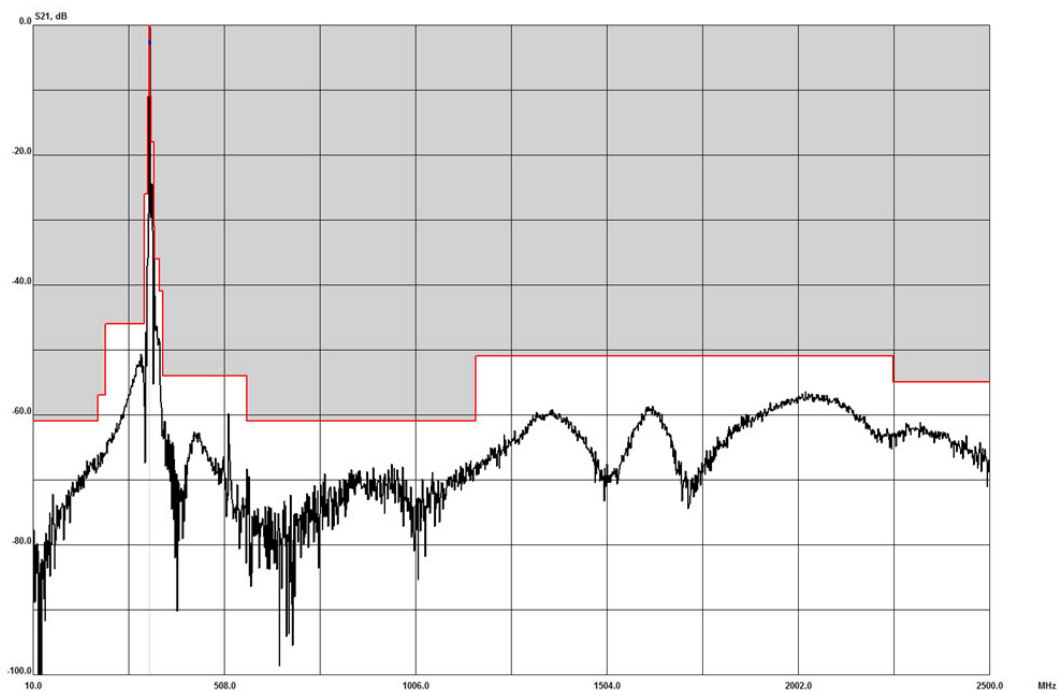

SM3030-6 Case

6-Terminal Ceramic Surface-Mount Case 3.0 X 3.0 mm Nominal Footprint

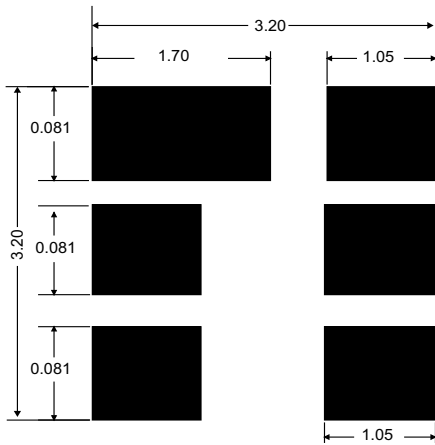
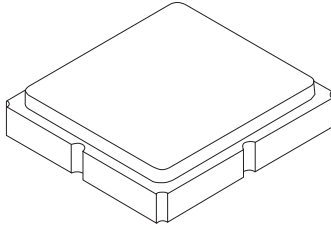

PCB Footprint (in millimeters)

Case Dimensions

Dimension	mm			Inches		
	Min	Nom	Max	Min	Nom	Max
A	2.90	3.00	3.10	0.114	0.118	0.122
B	2.90	3.00	3.10	0.114	0.118	0.122
C	--	-	1.40	-	-	0.055
D	-	-	1.00	-	-	0.039
E	-	1.50	-	-	0.059	-
F	-	0.60	-	-	0.023	-
G	-	1.60	-	-	0.062	-
H	-	2.80	-	-	0.110	-
I	-	1.30	-	-	0.051	-
J	-	0.85	-	-	0.033	-

Case Materials

Materials	
Solder Pad Plating	0.3 to 1.0 μm Gold over 1.27 to 8.89 μm Nickel
Lid Plating	2.0 to 3.0 μm Nickel
Body	Al_2O_3 Ceramic

TOP VIEW

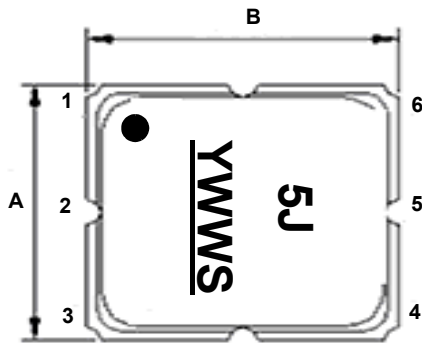

BOTTOM VIEW

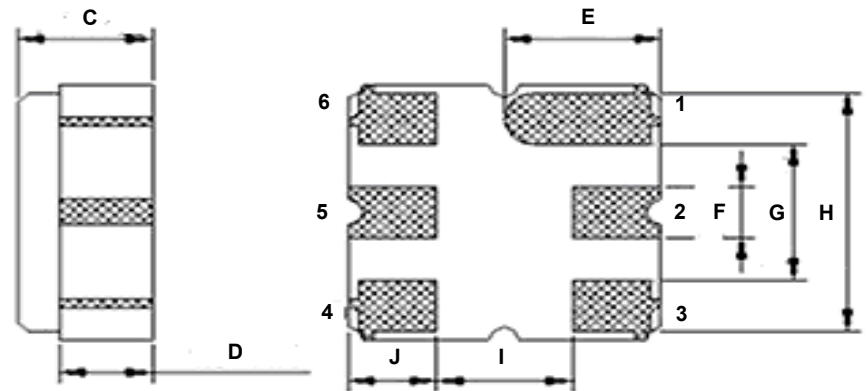

Tape and Reel Specifications

Tape and Reel Standard per ANSI/EIA-481

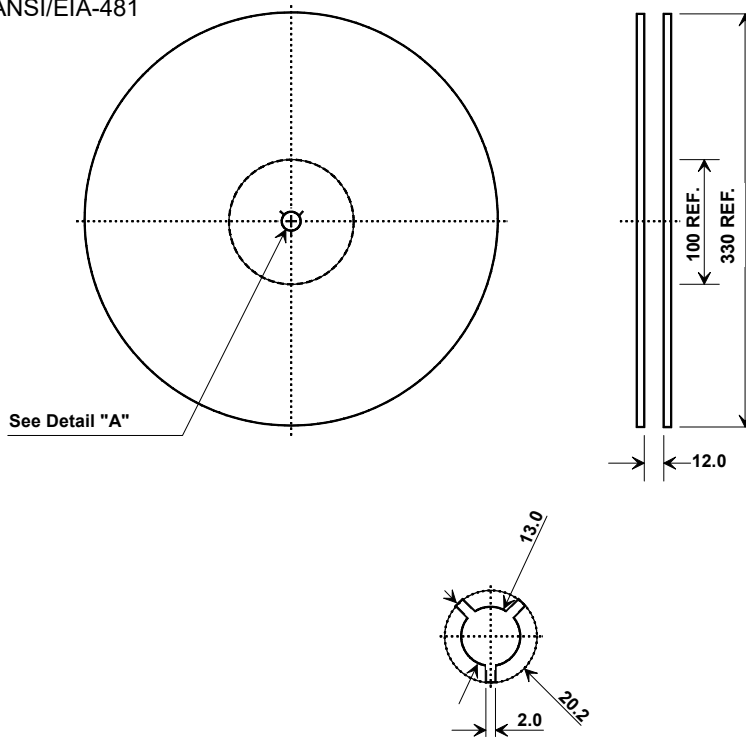

COMPONENT ORIENTATION and DIMENSIONS

Carrier Tape Dimensions	
Ao	4.25 mm
Bo	4.25 mm
Ko	1.30 mm
Pitch	8.0 mm
W	12.0 mm

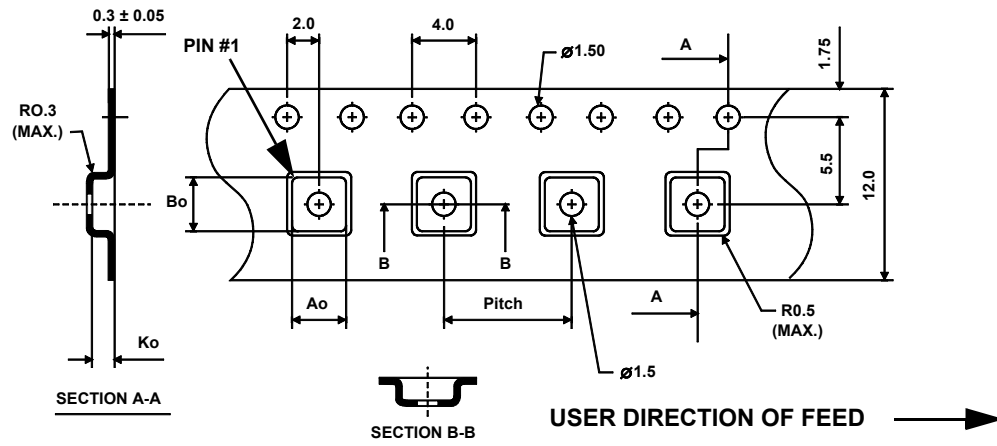

Recommended Reflow Profile

1. Preheating shall be fixed at 150~180°C for 60~90 seconds.
2. Ascending time to preheating temperature 150°C shall be 30 seconds min.
3. Heating shall be fixed at 220°C for 50~80 seconds and at 260°C +0/-5°C peak (10 seconds).
4. Time: 5 times maximum.

