

# Quick Start Manual for MLC1 Series Model

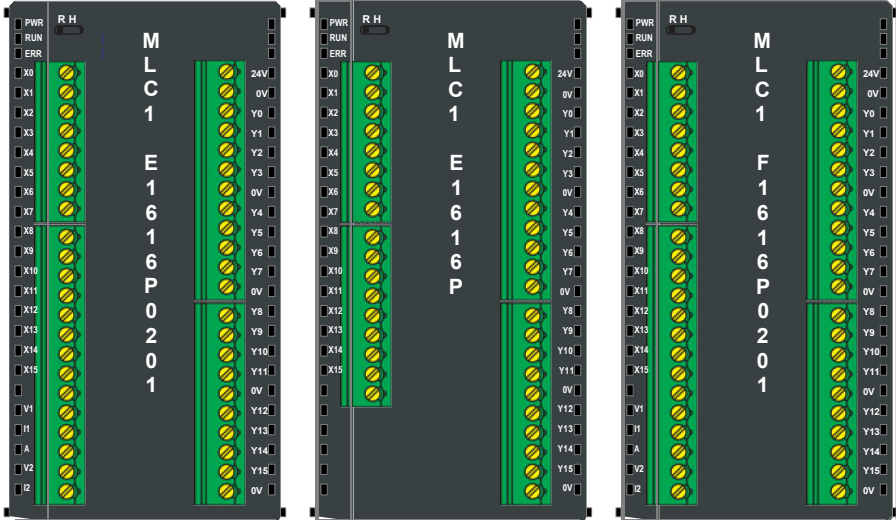

## MLC1-E1616P0201

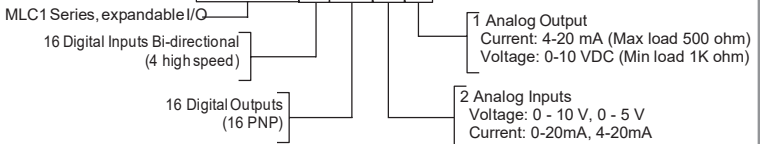

## MLC1-E1616P

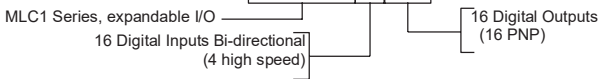

## MLC1-F1616P0201

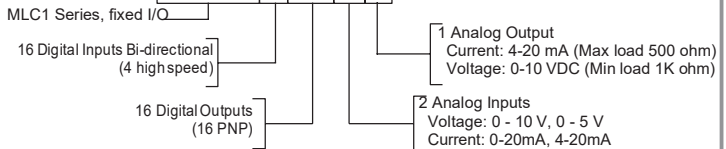

Panel mounting:

MLC1 units are shipped with a DIN rail slider & locking connector attached to the unit. User can use the unit with DIN rail slider.

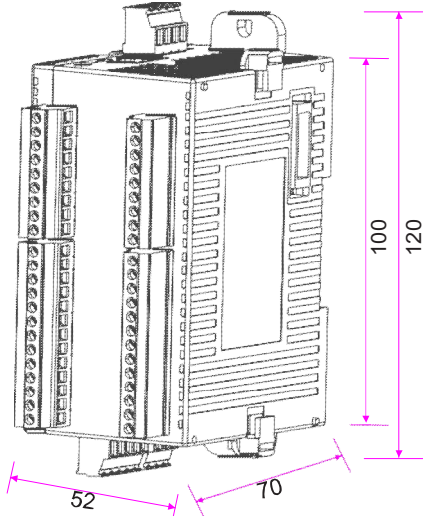

Dimensions are in mm.

MLC1 unit with DIN rail slider:  
Front View:

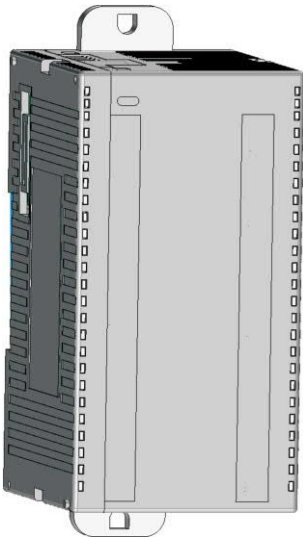

Rear View:

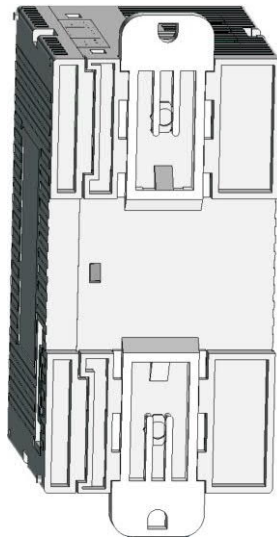

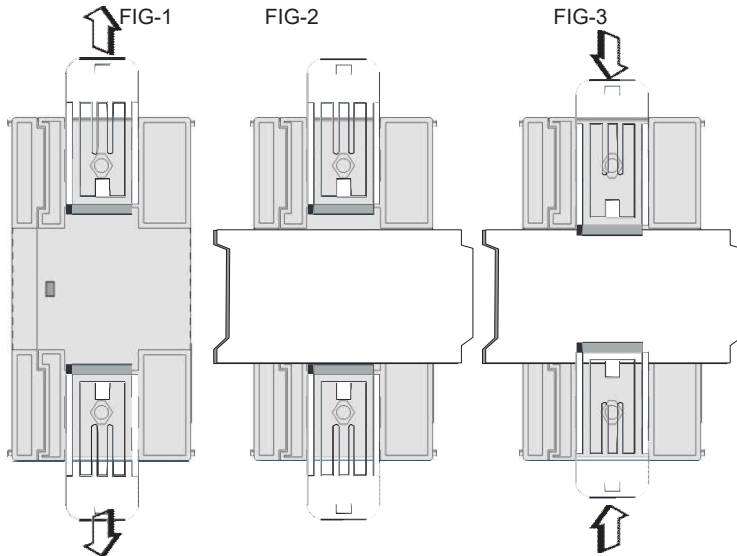

FIG-1 Pull up the sliders provided with the unit towards outward direction.  
 FIG-2 Rest the unit on the DIN rail plate  
 FIG-3 Pull down the slider again so that unit aligns with the DIN rail plate.

Grounding:



The optimum method for grounding electronic equipment is to ground it separately from other high-power systems, and to ground more than one unit of electronic equipment with a single-point ground. The grounding marked terminal (see below) is provided on the unit.

Note: Do not use a ground that has an unstable impedance, such as painted screws, or ground subject to vibration.

Contents:

- MLC1 unit
- Removable screw-type terminal blocks\*
- Removable power supply connector\*
- Quick Start Guide

\*Note: Connector manufacturer may vary.

Port Details

COM1: RJ45 Jack: RS232

COM2: Removable terminal (4 pin): 2 Wire RS485

USB Device:

- Compliant with USB 2.0 specification, self powered device.
- Standard micro USB Type B Female connector.

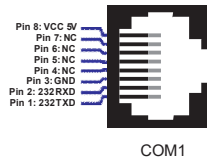
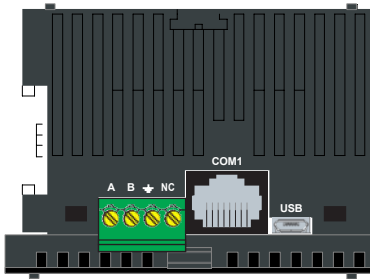

**Specifications:**

Power Supply: 24VDC, 500mA (+20%; -15%)  
 Standards: CE, UL (Class 1, Div 2)  
 Memory: Ladder Memory: 178 KB  
 Application Memory: 90 KB

**User Data:**

Input Registers: 400 words \*Max (X, XW)  
 Output Registers: 400 words \*Max (Y, YW)  
 Internal Registers: 256 words (B/BW)  
 Data Registers: 4096 words (D)  
 Retentive Registers: 1400 words (\*\*EEPROM)  
 System Registers: 256 words (SW)  
 Timers: 256 words (T./T)  
 Counters: 256 words (C./C)  
 System Devices: 100 points (S)  
 Config. Registers: 1600 words \*Max (M/MW)  
 Index Registers: 3 words (I, J, K)

**Note:**

\* : Depends upon I/O allocation.

\*\*Maximum 30,000 EEPROM write cycles allowed.

**Communication Ports**

2 COM Ports: COM1 (RJ45 Type): RS232  
 [For upload / download / communication / monitoring]  
 5VDC, 200mA power source  
 COM2 (Open terminals): 2-wire RS485 for communication  
 [1 for upload / download / monitoring]

**USB Device**

24V DC Digital Inputs:  
 Number of Inputs: 16 Inputs Bi-directional Type (4 high speed)  
 Input Design: According to EN 61131-2 Type 1  
 High Speed Inputs: X0, X1, X2, X3  
 High Speed Channels: 2  
 24V DC Digital Outputs:

Number of Outputs: 16 PNP (2 PWM)  
 Analog Inputs: 2 channels [Voltage: 0-10V, 0-5V; Current: 0-20mA, 4-20mA]  
 Analog Outputs: 1 channel [Current: 4 - 20 mA (Max load 500 ohm)]  
 [Voltage: 0 - 10 VDC (Min load 1000 ohm)]

**Analog specifications applicable to MLC1-E1616P0201 and -F1616P0201 models only.**

Up to sixteen MLE expansion I/O modules can be added to the MLC1-E CPU modules.

*Note: If the input wiring runs through an area subject to high electro-magnetic interference, please use the Digital Filter Instruction on the field inputs.*

**General**

Operating Temp.: 0 to 55°C.  
 Storage Temp: -20 to 85°C.  
 Relative Humidity: 10% to 90%  
 (non-condensing)  
 Vibration Tests: As per IEC60068-2-6  
 Shock Test: As per IEC60068-2-27

Wiring Diagram:  
Digital Inputs:

1. Normal Mode

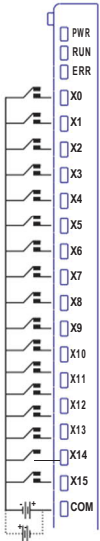

2. Single Phase Up counter

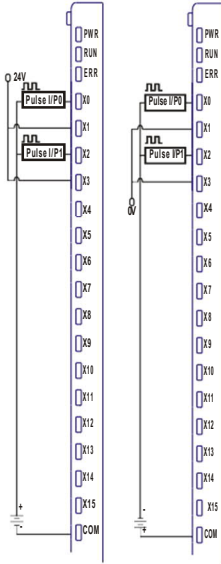

3. Single Phase Down counter

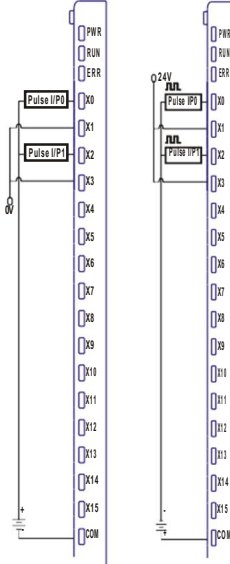

4. Quadrature:

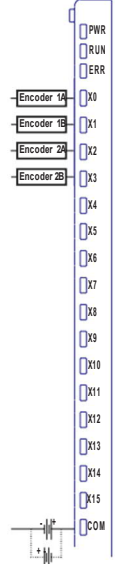

Analog Inputs (-E1616P0201 and -F1616P0201 models):  
Current Voltage

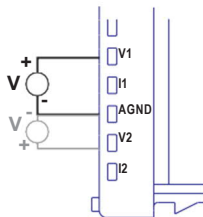
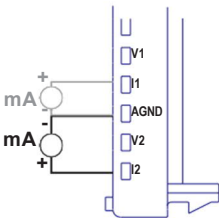

Digital Outputs:

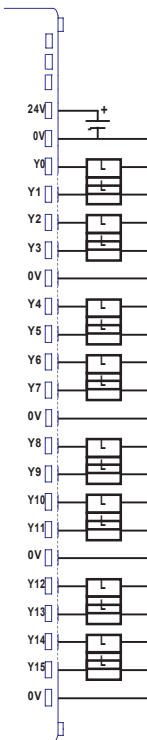

Analog Outputs (-E1616P0201 and -F1616P0201 models):

Current:

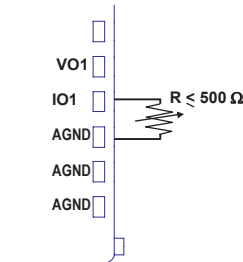

Voltage:

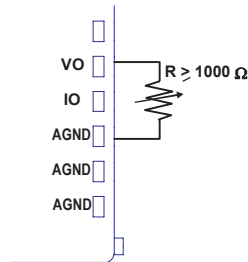

**WARNING:**

This equipment is suitable for use in Class I, Division 2, Groups A, B, C and D or non-hazardous locations only.

WARNING – EXPLOSION HAZARD – Do not disconnect equipment unless power has been removed or the area is known to be non-hazardous.

WARNING – EXPLOSION HAZARD - Substitution of components may impair suitability for Class I, Division 2.

WARNING - CAUTION, battery may explode if mistreated. Do not recharge, disassemble or dispose of in fire.

WARNING - Replace battery with type CR1225FH-LF, manufactured by Renata SA, only. Use of another battery may present a risk of fire or explosion.

It is recommended that the user periodically inspect the product for any degradation of properties and replace the device if any degradation is found.

Class I Division 2 Wiring Considerations

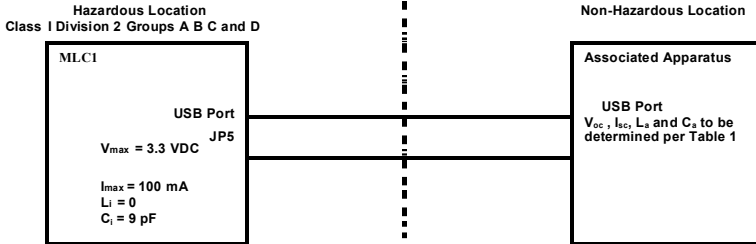

Capacitance and inductance of the field wiring from the nonincendive equipment to the associated apparatus shall be calculated and must be included in the system calculations as shown in Table 1. Where the cable capacitance and inductance per foot are not known, the following values shall be used. Ccable = 60 pF/ft., Lcable = 0.2µH/ft.

Wiring method must be in accordance with ANSI/NFPA70

TABLE 1:

Nonincendive Equipment	Associated Apparatus
$V_{max} \text{ (or } U_i)$	$V_{oc} \text{ or } V_t \text{ (or } U_o)$
$I_{max} \text{ (or } I_i)$	$I_{sc} \text{ or } I_t \text{ (or } I_o)$
$C_i + C_{cable}$	$C_a \text{ (or } C_o)$
$L_i + L_{cable}$	$L_a \text{ (or } L_o)$

This quick start guide gives you a quick overview of the model and specifications. Read this guide thoroughly before installing and operating the unit. For detailed information on this product refer to MAPware-7000 manual. You can download this manual free from the download section of our website. For a printed copy of this manual contact Maple Systems, Inc.

This document is based on information available at the time of its publication and may not cover all the details or variations in hardware or software. Maple Systems, Inc. reserves the right to update information in this publication without prior notice.

Technical Support

For technical support please provide the unit serial number and revision number written on the address sticker of the unit. Provide information regarding the external HMI/PLC if used in application. Also include your application, if possible.

Maple Systems, Inc.  
808 134th St. SW, Suite 120  
Everett, WA 98204-7333  
Tel: (425) 745-3229  
Fax: (425) 745-3429  
E-mail: support@maplesystems.com  
Website: www.maplesystems.com

Notes: