

# Approval Sheet

## (產品承認書)

產品名稱 (Product)	<u>Bluetooth Low Energy Module</u>
解決方案 (Solution)	<u>Nordic nRF52811 QFN Package</u>
產品型號 (Model No.)	<u><b>MDBT42Q – 192KL</b> (Chip Antenna)</u> <u><b>MDBT42Q – P192KL</b> (PCB Antenna)</u>
產品料號 (Part No.)	<u>see <a href="#">4.3 Order Code</a></u>

*Advantage of MDBT42Q & MDBT42Q-P series:*

- 1. Long working distance:*  
**MDBT42Q:** over 80 meters in open space.  
**MDBT42Q-P:** up to 60 meters in open space.
- 2. Declaration ID includes all Nordic applied profiles.*
- 3. Granted main regional certification such as FCC (USA), CE(EU)  
TELEC (Japan), SRRC (China), IC (Canada), NCC (Taiwan), and KC (South Korea).*

# Index

<b>1. Overall Introduction</b>	<b>4</b>
1.1. Application	4
1.2. Features	5
<b>2. Product Dimension</b>	<b>6</b>
2.1. PCB Dimensions & Pin Indication	6
2.2. Recommended Layout of Solder Pad	8
2.3. RF Layout Suggestion (aka Keep-Out Area)	12
2.4. Footprint & Design Guide	14
2.5. Pin Assignment	15
2.6. GPIO Located Near the Radio	17
<b>3. Main Chip Solution</b>	<b>17</b>
<b>4. Shipment Packaging Information</b>	<b>18</b>
4.1. Marking on Metal Shield	19
4.2. Packaging Info	20
4.3. Order Code	22
<b>5. Specification</b>	<b>23</b>
5.1. Absolute Maximum Ratings	23
5.2. Operation Conditions	23
5.3. Electrical Specifications	24
<b>6. Block Diagram</b>	<b>30</b>
<b>7. Antenna</b>	<b>31</b>
7.1. MDBT42Q Series	31
7.2. MDBT42Q-P Series	32
<b>8. Reference Circuit</b>	<b>33</b>
<b>9. Certification</b>	<b>34</b>
9.1. Declaration ID	34
9.2. FCC Certificate (USA)	36
9.3. TELEC Certificate (Japan)	38
9.4. NCC Certificate (Taiwan)	40
9.5. CE Test Report (EU)	42
9.6. IC Certificate (Canada)	44
9.7. SRRC Certificate (China)	46

9.8. KC Certificate (South Korea) .....	47
9.9. RoHS & REACH Report .....	48
9.10. End-Product Label .....	48
<b>10. Notes and Cautions.....</b>	<b>50</b>
<b>11. Basic Facts for nRF52 Chip.....</b>	<b>51</b>
<b>12. Useful Links .....</b>	<b>52</b>
<b>Full List of Raytac's BLE Modules .....</b>	<b>53</b>
<b>Release Note.....</b>	<b>57</b>

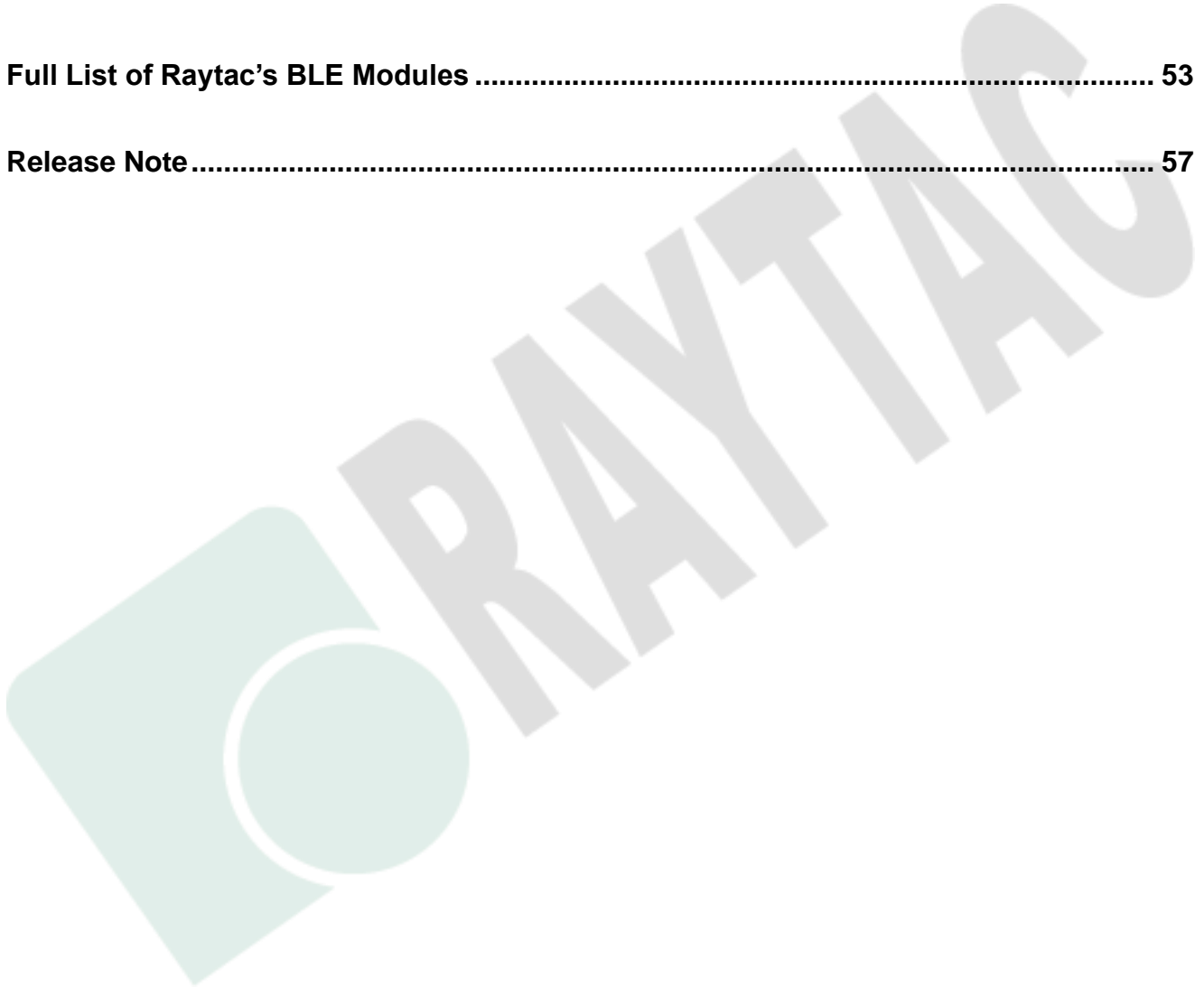

# 1. Overall Introduction

Raytac's MDBT42Q-192KL & MDBT42Q-P192KL is a BT 5.2 stack (Bluetooth low energy or BLE) module designed based on **Nordic nRF52811 SoC solution**, which incorporates: **GPIO, SPI, UART, I2C, PWM** and **ADC** interfaces for connecting peripherals and sensors.

Features:

1. Dual Transmission mode of BLE & 2.4Ghz RF upon customer preference.
2. Compact size with **(L) 16 x (W) 10 x (H) 2.2 mm**.
3. Low power requirements, ultra-low peak, average and idle mode power consumption.
4. Be compatible with a large installed base of mobile phones, tablets and computers.
5. Fully coverage of BLE software stack.
6. BLE & RF transmission switching helps products fit all operation system and most hardware.

## 1.1. Application

- Personal Area Networks
  - Health / fitness sensor and monitor device
  - Medical devices
  - Key-fobs and wrist watches
- Interactive entertainment devices
  - Remote control
  - Gaming controller
  - Virtual reality headsets
- Enterprise Lighting
- Beacons
- Computer peripherals and I/O devices
  - Mouse
  - Keyboard
  - Multi-touch trackpad

## 1.2. Features

- Bluetooth 5, IEEE 802.15.4, 2.4 GHz transceiver
  - -97dBm sensitivity in 1 Mbps Bluetooth low energy (BLE) mode
  - -104dBm sensitivity in 125 Kbps BLE mode (long range)
  - -20 to +4 dBm TX power, configurable in 4 dB steps
  - On-air compatible with nRF52, nRF51, nRF24L and nRF24AP Series
  - RSSI (1dB resolution)
  - Supported data rates:
    - Bluetooth 5: 2 Mbps, 1 Mbps, 500 kbps, 125 kbps
    - IEEE 802.15.4-2006: 250 kbps
    - Proprietary 2.4 GHz: 2 Mbps, 1 Mbps
- Angle-of-arrival (AoA) and angle-of-departure (AoD) direction finding using Bluetooth.
- ARM Cortex –M4 32-bit processor with FPU, 64 MHz
- Memory: 192 kB flash / 24 kB RAM
- 32 general purpose I/O pins
- 12 bit, 200ksps ADC – 8 configurable channels with programmable gain
- 4-channel pulse width modulator (PWM) units with EasyDMA
- Digital microphone interface (PDM)
- 2 x SPI master/slave with EasyDMA
- I2C compatible 2-wire masters / slaves
- 1 x UART(CTS/RTS) with EasyDMA
- Quadrature decoder (QDEC)
- 2 x real-time counters (RTC)
- Flexible power management
  - Supply voltage range 1.7V to 3.6V
  - Fully automatic LDO and DC/DC regulator system
  - Fast wake-up using 64MHz internal oscillator
  - 0.3 uA at 3V in System OFF mode, no RAM retention
  - 0.5 uA at 3V in System OFF mode with full 24 kb RAM retention
  - 1.5 uA at 3V in System ON mode, with full 24 kb RAM retention, wake on RTC
  - 1.4 uA at 3V in System ON mode, no RAM retention, wake on RTC
- Nordic SoftDevice ready and with support for concurrent multi-protocol

## 2. Product Dimension

### 2.1. PCB Dimensions & Pin Indication

- **MDBT42Q**

PCB Size (in mm)			
	Min.	Norm	MAX.
L		16	
W	- 0.15	10	+ 0.2
H		2.2	

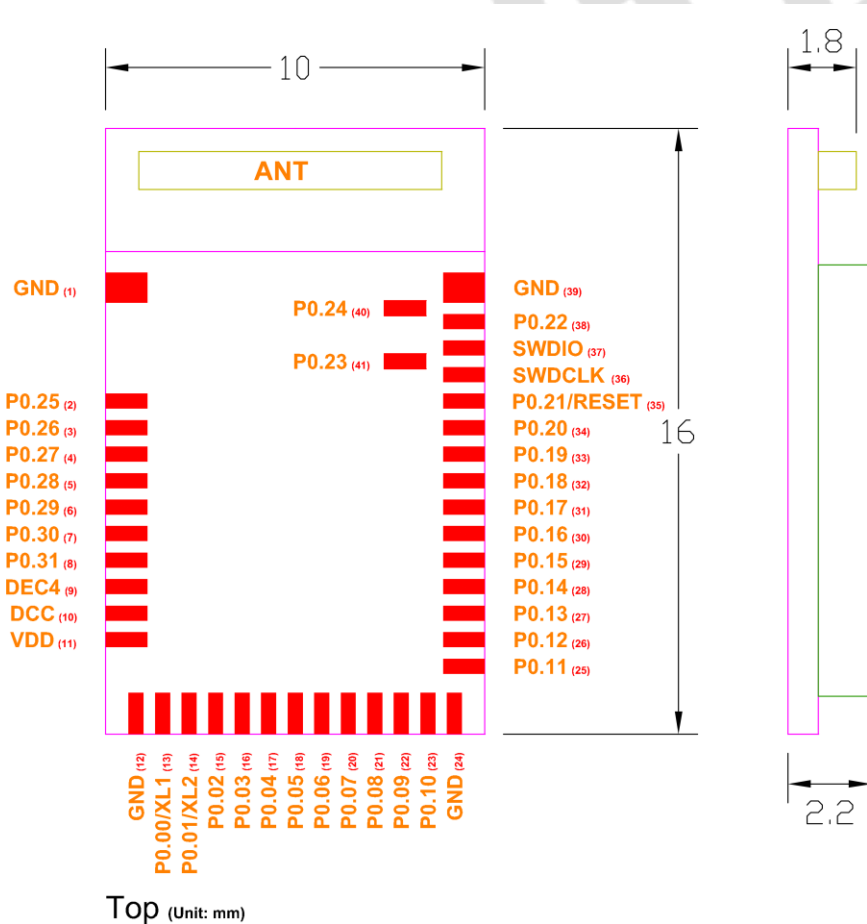

**\* Please be careful of the amount of solder paste for P0.23 & P0.24. The module may be lifted due to excess solder. Pads for P0.23 & P0.24 can be omitted when two GPIOs were not used.**

• **MDBT42Q-P**

<b>PCB Size (in mm)</b>			
	<b>Min.</b>	<b>Norm</b>	<b>MAX.</b>
<b>L</b>		<b>16</b>	
<b>W</b>	<b>- 0.15</b>	<b>10</b>	<b>+ 0.2</b>
<b>H</b>		<b>2.2</b>	

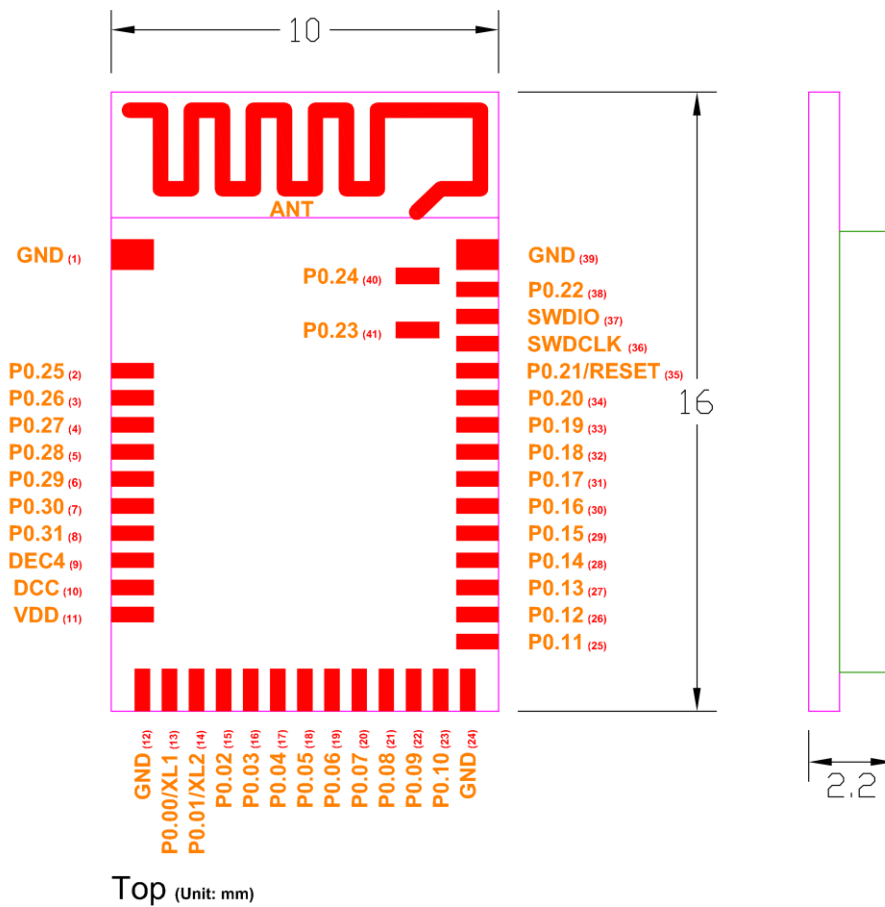

**\* Please be careful of the amount of solder paste for P0.23 & P0.24. The module may be lifted due to excess solder. Pads for P0.23 & P0.24 can be omitted when two GPIOs were not used.**

## 2.2. Recommended Layout of Solder Pad

*Graphs are all in Top View, Unit in mm.*

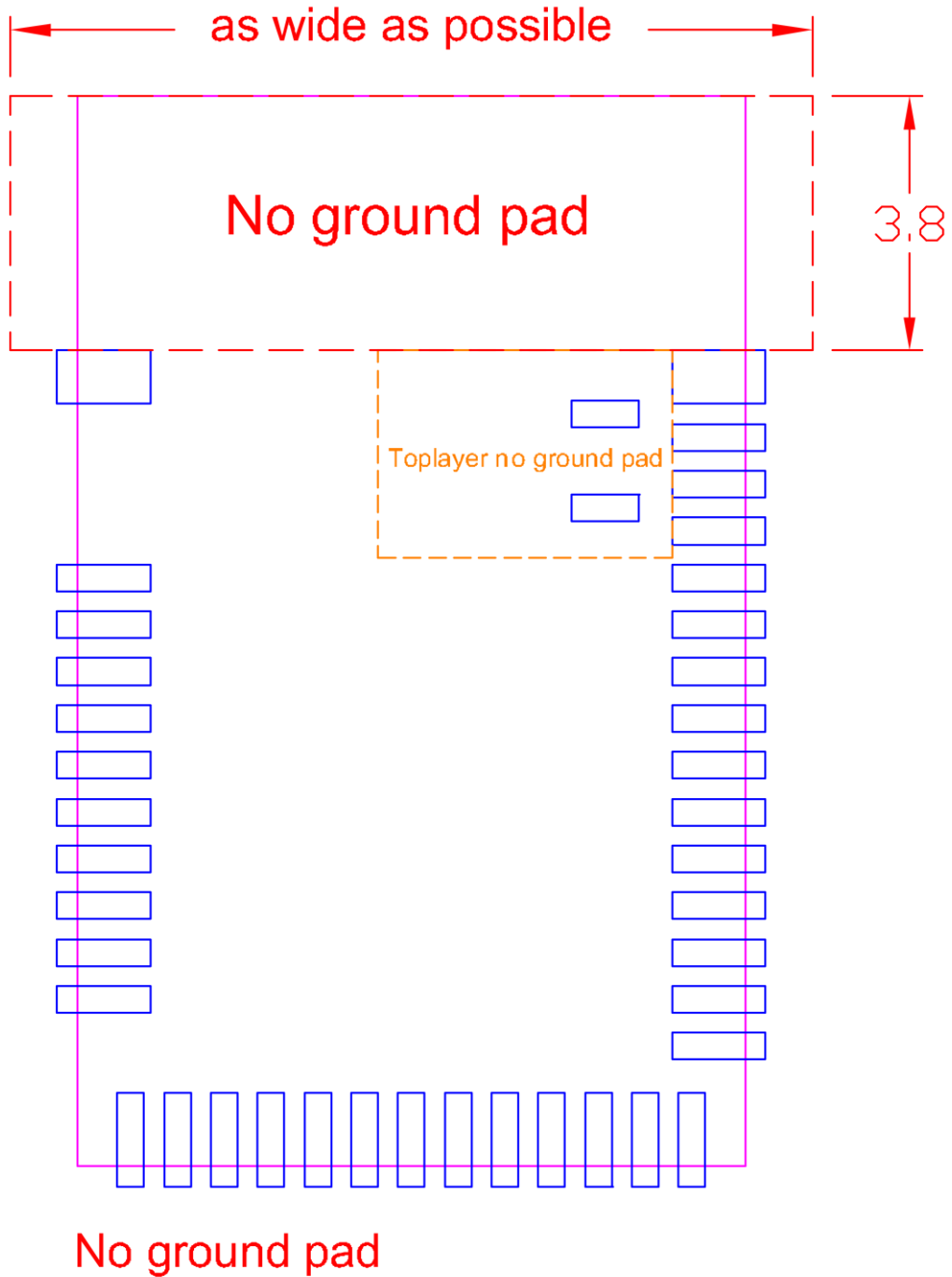



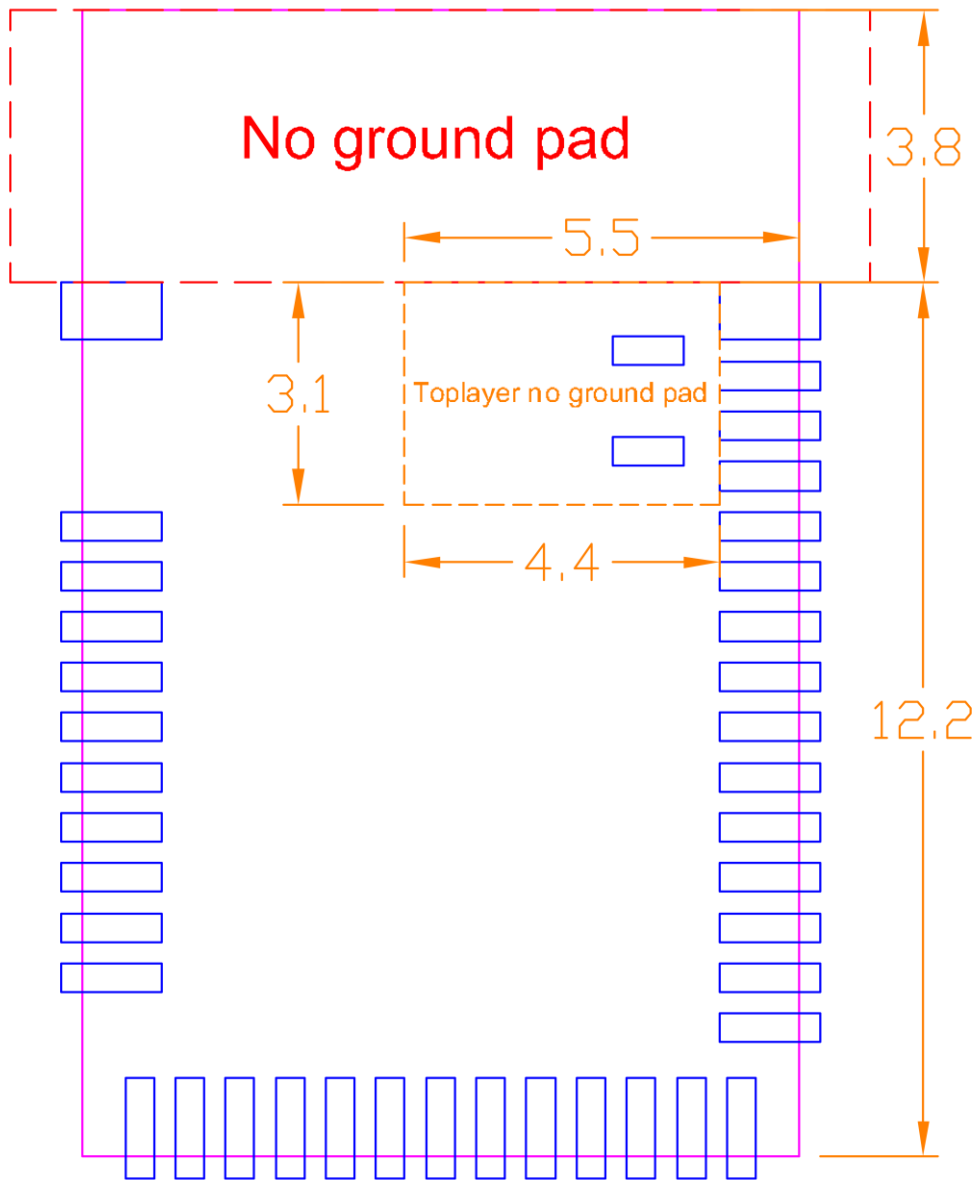

Toplayer no ground pad

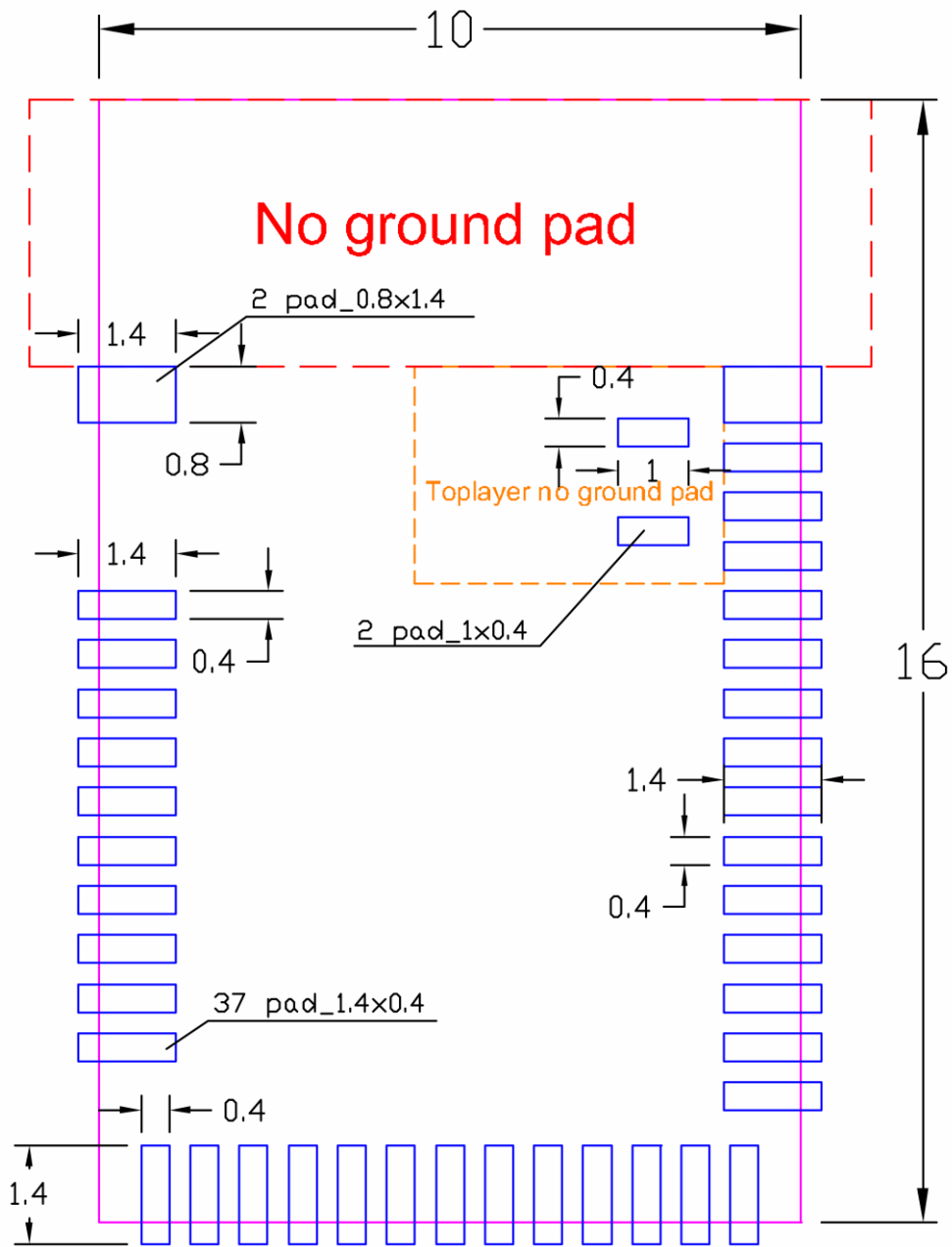



## 2.3. RF Layout Suggestion (aka Keep-Out Area)

Make sure to keep the “No Ground Pad” as wider as you can regardless of the size of your PCB.

No-Ground Pad should be included in the corresponding position of the antenna in **EACH LAYER**.

Place the module towards the edge of PCB to have better performance than placing it on the center.

Welcome to send us your layout in PDF for review at [service@raytac.com](mailto:service@raytac.com) or your contact at Raytac with title “Layout reviewing –Raytac model no.–YOUR company’s name”.

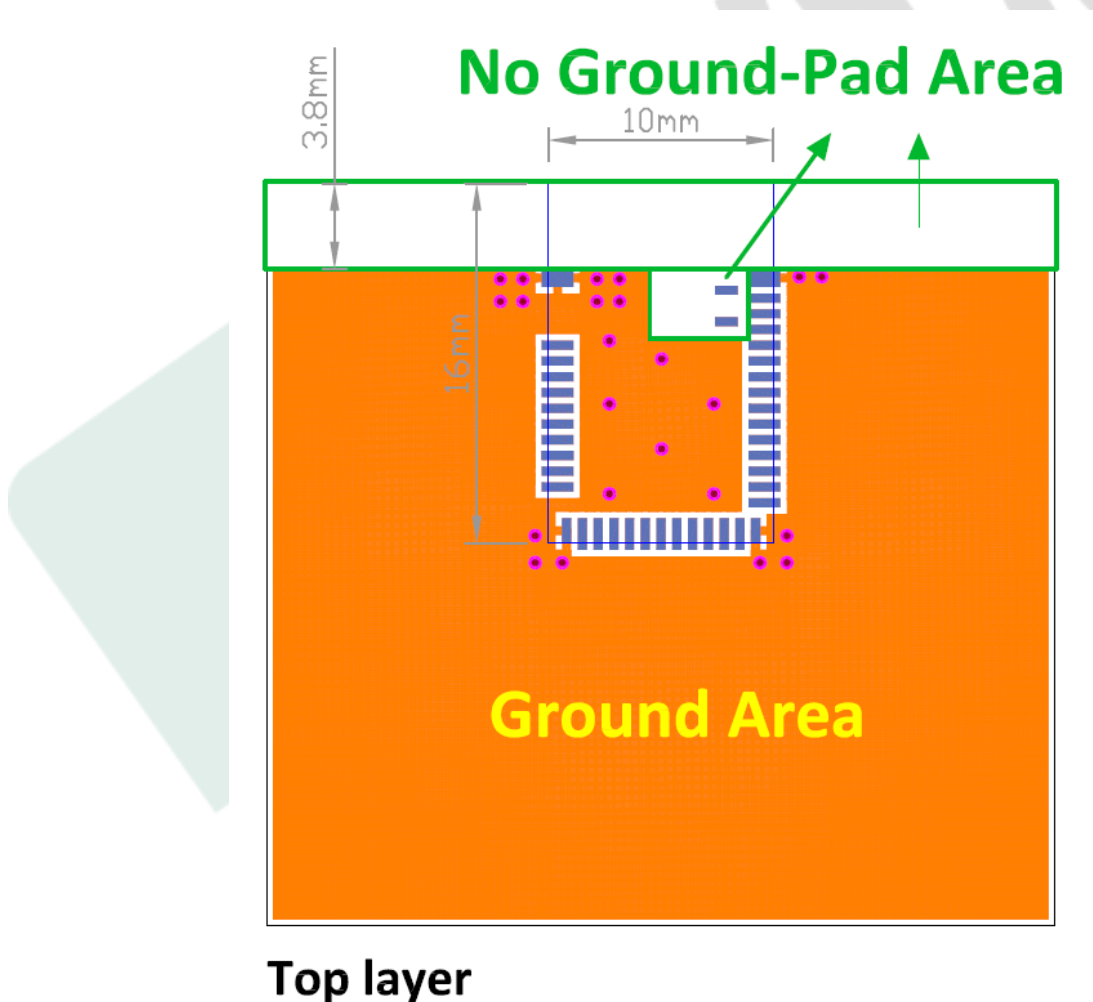

**Please add via holes in these areas as many as possible**

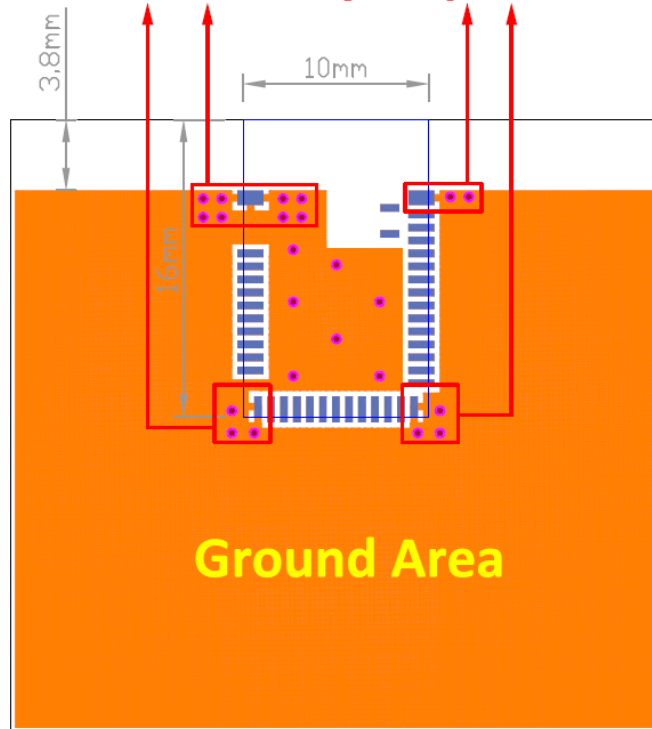

**Top layer**

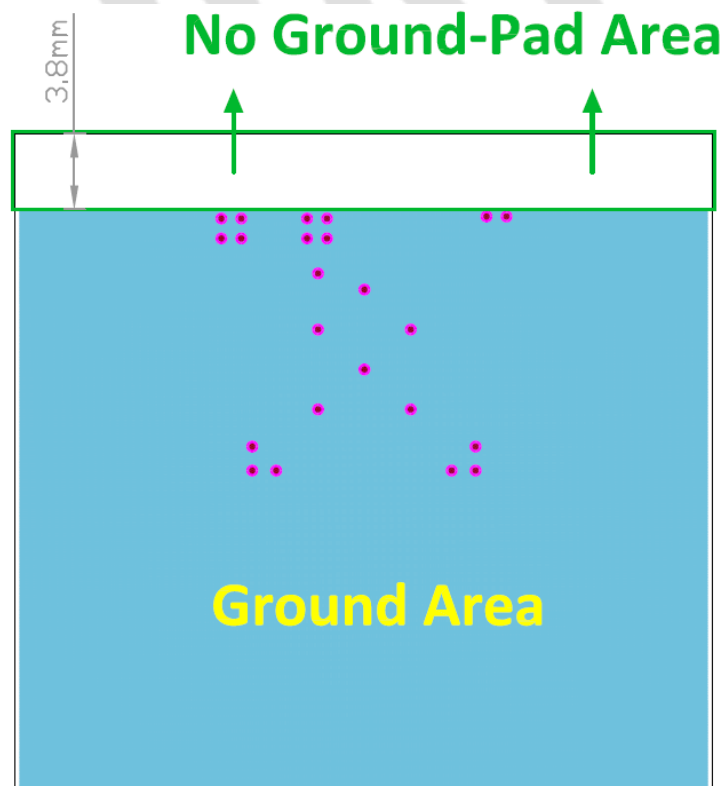

**Bottom layer**

Examples of “**NOT RECOMMENDED**” layout

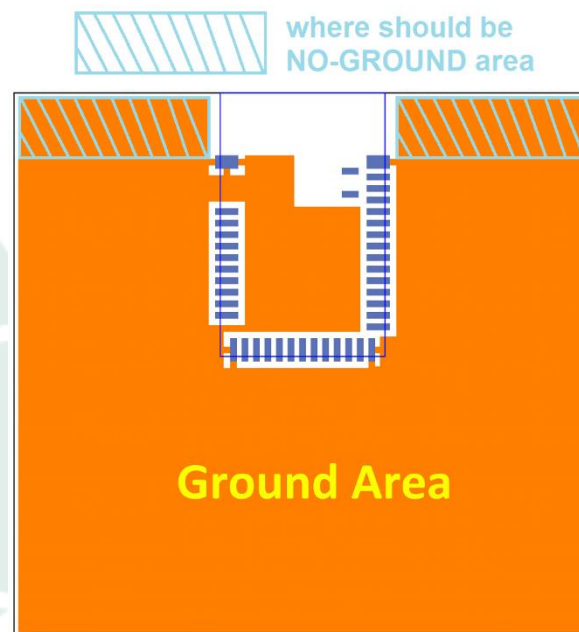
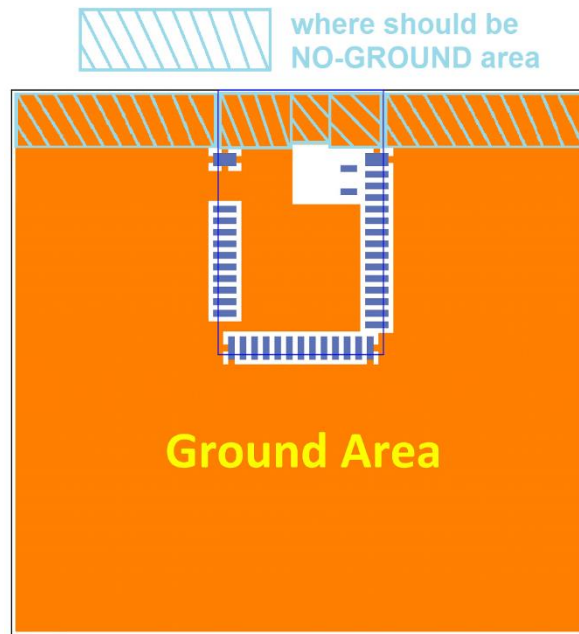

## 2.4. Footprint & Design Guide

Please visit “[Support](#)” page of our website to download. The package includes footprint, 2D/3D drawing, reflow graph and recommended spec for external 32.768khz.

## 2.5. Pin Assignment

Pin No.	Name	Pin function	Description
(1)	<b>GND</b>	Ground	The pad must be connected to a solid ground plane
(2)	<b>P0.25</b>	Digital I/O	General-purpose digital I/O
(3)	<b>P0.26</b>	Digital I/O	General-purpose digital I/O
(4)	<b>P0.27</b>	Digital I/O	General-purpose digital I/O
(5)	<b>P0.28</b>	Digital I/O	General-purpose digital I/O
	<b>AIN4</b>	Analog input	SAADC/COMP input
(6)	<b>P0.29</b>	Digital I/O	General-purpose digital I/O
	<b>AIN5</b>	Analog input	SAADC/COMP input
(7)	<b>P0.30</b>	Digital I/O	General-purpose digital I/O
	<b>AIN6</b>	Analog input	SAADC/COMP input
(8)	<b>P0.31</b>	Digital I/O	General-purpose digital I/O
	<b>AIN7</b>	Analog input	SAADC/COMP input
(9)	<b>DEC4</b>	Power	1V3 regulator supply decoupling. Input from DC/DC converter. Output from 1V3 LDO
(10)	<b>DCC</b>	Power	DC/DC converter output pin
(11)	<b>VDD</b>	Power	Power-supply pin
(12)	<b>GND</b>	Ground	The pad must be connected to a solid ground plane
(13)	<b>P0.00</b>	Digital I/O	General-purpose digital I/O
	<b>XL1</b>	Analog input	Connection to 32.768khz crystal (LFXO)
(14)	<b>P0.01</b>	Digital I/O	General-purpose digital I/O
	<b>XL2</b>	Analog input	Connection to 32.768khz crystal (LFXO)
(15)	<b>P0.02</b>	Digital I/O	General-purpose digital I/O
	<b>AIN0</b>	Analog input	SAADC/COMP input
(16)	<b>P0.03</b>	Digital I/O	General-purpose digital I/O
	<b>AIN1</b>	Analog input	SAADC/COMP input
(17)	<b>P0.04</b>	Digital I/O	General-purpose digital I/O
	<b>AIN2</b>	Analog input	SAADC/COMP input
(18)	<b>P0.05</b>	Digital I/O	General-purpose digital I/O
	<b>AIN3</b>	Analog input	SAADC/COMP input
(19)	<b>P0.06</b>	Digital I/O	General-purpose digital I/O
(20)	<b>P0.07</b>	Digital I/O	General-purpose digital I/O

Pin No.	Name	Pin function	Description
(21)	P0.08	Digital I/O	General-purpose digital I/O
(22)	P0.09	Digital I/O	General-purpose digital I/O
(23)	P0.10	Digital I/O	General-purpose digital I/O
(24)	GND	Ground	The pad must be connected to a solid ground plane
(25)	P0.11	Digital I/O	General-purpose digital I/O
(26)	P0.12	Digital I/O	General-purpose digital I/O
(27)	P0.13	Digital I/O	General-purpose digital I/O
(28)	P0.14	Digital I/O	General-purpose digital I/O
(29)	P0.15	Digital I/O	General-purpose digital I/O
(30)	P0.16	Digital I/O	General-purpose digital I/O
(31)	P0.17	Digital I/O	General-purpose digital I/O
(32)	P0.18	Digital I/O	General-purpose digital I/O
(33)	P0.19	Digital I/O	General-purpose digital I/O
(34)	P0.20	Digital I/O	General-purpose digital I/O
(35)	P0.21	Digital I/O	General-purpose digital I/O
	RESET		Configurable as system RESET pin
(36)	SWDCLK	Digital input	Serial Wire debug clock input for debug and programming
(37)	SWDIO	Digital I/O	Serial Wire debug I/O for debug and programming
(38)	P0.22	Digital I/O	General-purpose digital I/O
(39)	GND	Ground	The pad must be connected to a solid ground plane
(40)	P0.24	Digital I/O	General-purpose digital I/O
(41)	P0.23	Digital I/O	General-purpose digital I/O



## 2.6. GPIO Located Near the Radio

Some GPIO have recommended usage. To maximize RF performance, these GPIO are only available to use as **low drive, low frequency I/O only**. Wrong usage may lead to undesirable performance. Here is the list of these GPIO:

*Low frequency I/O is a signal with a frequency up to 10 kHz. SPI, I2C, UART, PWM are NOT low frequency I/O.*



Module Pin	GPIO
2	P0.25
3	P0.26
4	P0.27
5	P0.28
6	P0.29

## 3. Main Chip Solution

RF IC	Crystal Frequency
Nordic NRF52811	32MHZ

*32MHz crystal is already inside the module.*

## 4. Shipment Packaging Information

Model	Antenna	Photo
MDBT42Q-192KL	Chip/Ceramic	
MDBT42Q-P192KL	PCB/Printed	

- Unit Weight of Module:

MDBT42Q-192KL: 0.64 g ( $\pm 0.02$  g) ; MDBT42Q-P192KL: 0.62 g ( $\pm 0.02$  g)

- Packaging Type: Anti-static tray or Tape & Reel

	Tray	Tape & Reel
<b>MPQ (Min. Package Q'ty)</b>	88 pcs per tray	1,500 pcs per reel
<b>Carton Contents (per carton)</b>	1,760 pcs	1,500 pcs
<b>Carton Dimension (L) x (W) x (H) cm</b>	37 x 21 x 13	37 x 36 x 6
<b>Gross Weight</b>	about 2.8 kgs	about 1.9 kgs

## 4.1. Marking on Metal Shield

Raytac Corporation  
FCC ID: SH6MDBT42Q  
IC: 8017A-MDBT42Q  
CMIIT ID: 2016DJ4571  
Model No.: MDBT42Q

    201-160496



## 4.2. Packaging Info

### 4.2.1. Tray Packaging

Anti-static tray is specifically designed for mass production. It can be used directly on SMT automatic machine.

**Before July 1st, 2022**

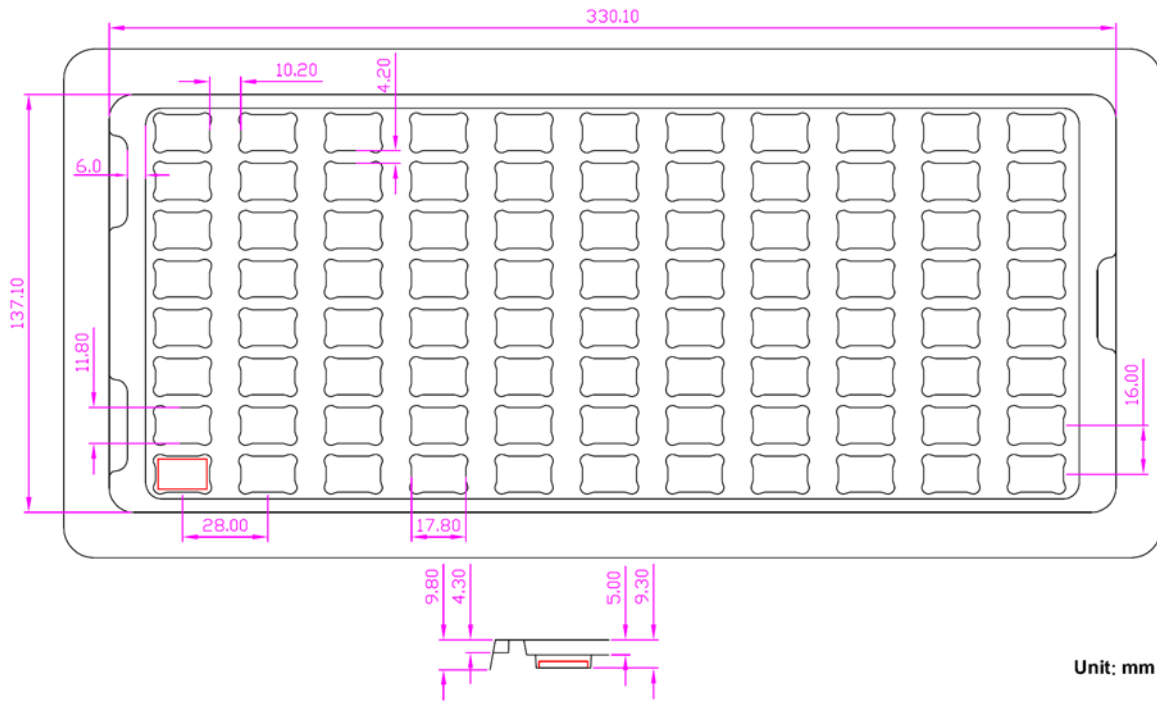

**After July 1st, 2022**

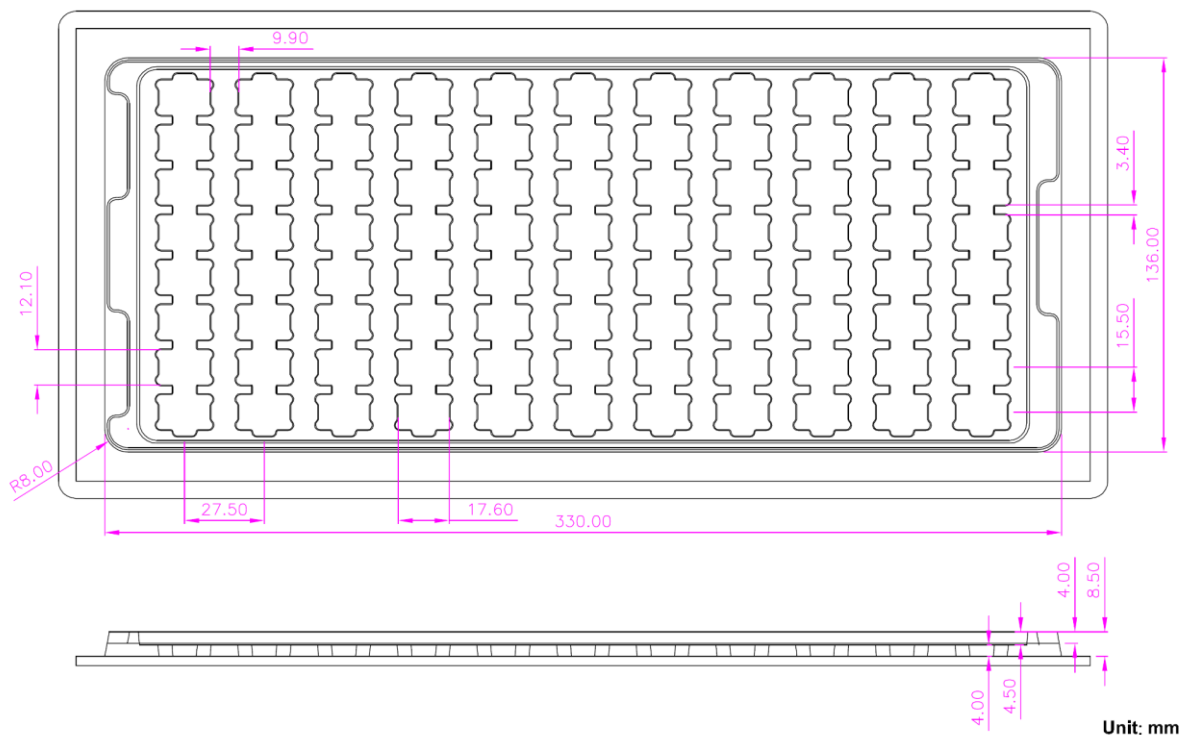

## 4.2.2. Reel Packaging

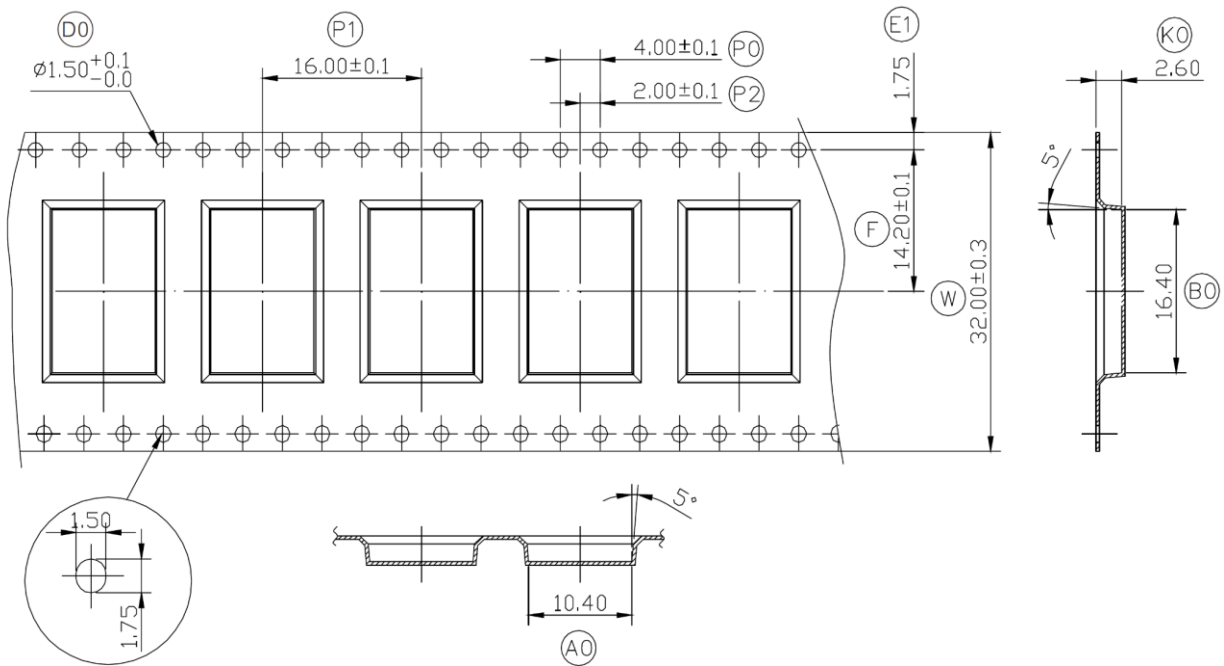

W	<b>32.00</b>	$\pm 0.30$
P1	<b>16.00</b>	$\pm 0.10$
E1	<b>1.75</b>	$\pm 0.10$
F	<b>14.20</b>	$\pm 0.10$
D0	<b>1.50</b>	$+0.1/-0$
P0	<b>4.00</b>	$\pm 0.10$
P2	<b>2.00</b>	$\pm 0.10$
A0	<b>10.40</b>	$\pm 0.10$
B0	<b>16.40</b>	$\pm 0.10$
K0	<b>2.60</b>	$\pm 0.10$
T	<b>0.30</b>	$\pm 0.05$

### 4.3. Order Code

Each model has two options of packaging. Please use following part no. when placing order to us.

<b>Model</b>	<b>Tray</b>	<b>Tape &amp; Reel</b>
MDBT42Q-192KL	MD-240A2-S52	MD-240A2-S52R
MDBT42Q-P192KL	MD-240A2-S53	MD-240A2-S53R

***MPQ of Reel packaging is 1,500 pcs and Tray packaging is 88 pcs.***

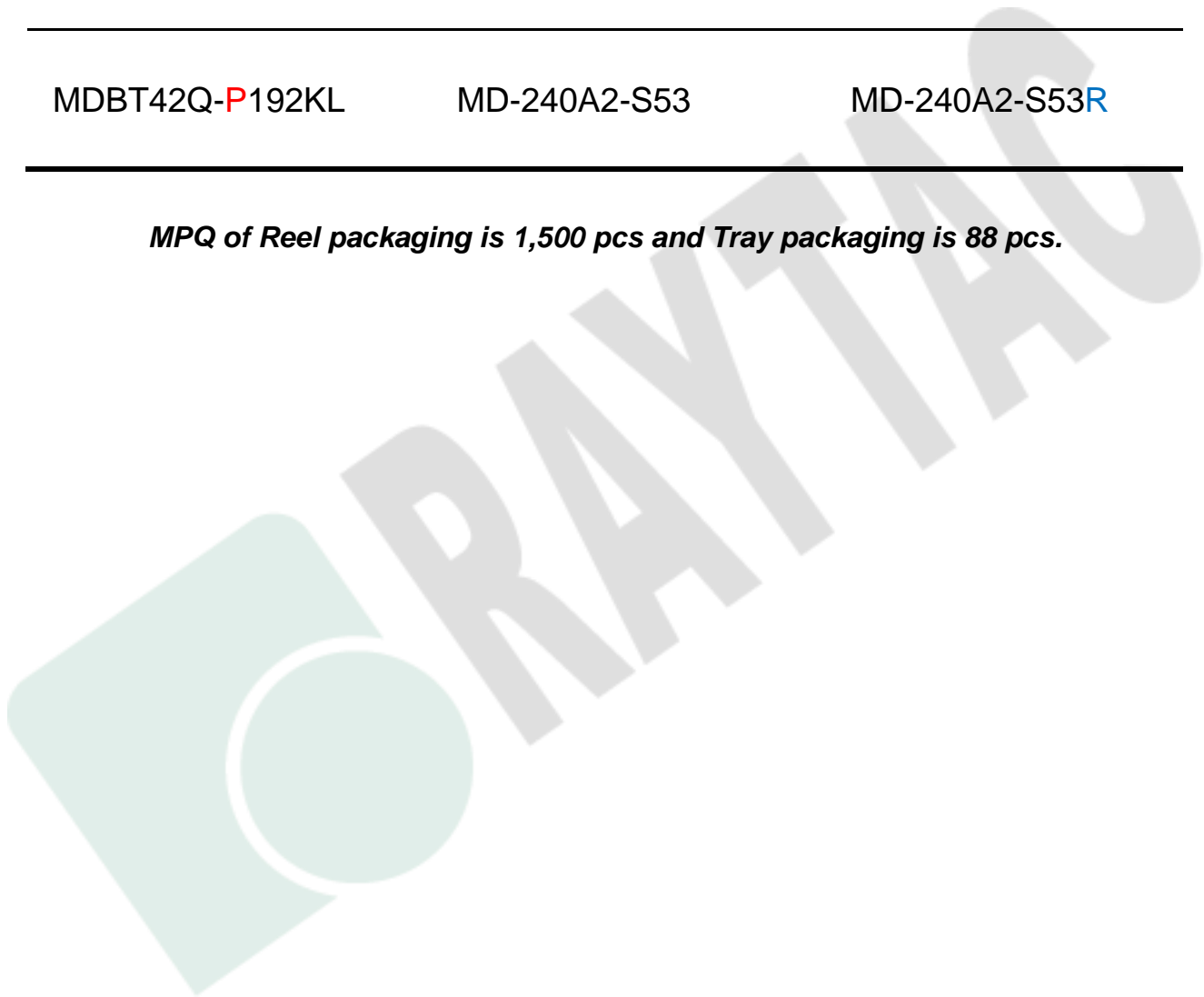

## 5. Specification

Any technical spec shall refer to Nordic's official documents as final reference. Contents below are from "[nRF52811 Product Specification v1.1](#)", please click to download full spec.

### 5.1. Absolute Maximum Ratings

	Note	Min.	Max.	Unit
<b>Supply voltages</b>				
VDD		-0.3	+3.9	V
VSS			0	V
<b>I/O pin voltage</b>				
$V_{I/O}$ , VDD $\leq$ 3.6 V		-0.3	VDD + 0.3	V
$V_{I/O}$ , VDD > 3.6 V		-0.3	3.9	V
<b>Radio</b>				
RF input level			10	dBm
<b>Environmental QFN package</b>				
Storage temperature		-40	+125	°C
MSL	Moisture Sensitivity Level		2	
ESD HBM	Human Body Model		3	kV
ESD HBM Class	Human Body Model Class		2	
ESD CDM	Charged Device Model		1	kV
<b>Flash memory</b>				
Endurance		10 000		Write/erase cycles
Retention at 85 °C		10		years

### 5.2. Operation Conditions

Symbol	Parameter	Notes	Min.	Nom.	Max.	Units
VDD	Supply voltage, independent of DCDC enable		1.7	3.0	3.6	V
$t_{R\_VDD}$	Supply rise time (0 V to 1.7 V)				60	ms
TA	Operating temperature		-40	25	85	°C

**Important:** The on-chip power-on reset circuitry may not function properly for rise times longer than the specified maximum.

## 5.3. Electrical Specifications

### 5.3.1. General Radio Characteristics

Symbol	Description	Min.	Typ.	Max.	Units
$f_{OP}$	Operating frequencies	2360		2500	MHz
$f_{PLL,CH,SP}$	PLL channel spacing		1		MHz
$f_{DELTA,1M}$	Frequency deviation @ 1 Mbps		$\pm 170$		kHz
$f_{DELTA,BLE,1M}$	Frequency deviation @ BLE 1 Mbps		$\pm 250$		kHz
$f_{DELTA,2M}$	Frequency deviation @ 2 Mbps		$\pm 320$		kHz
$f_{DELTA,BLE,2M}$	Frequency deviation @ BLE 2 Mbps		$\pm 500$		kHz
$f_{skBPS}$	On-the-air data rate	125		2000	kbps
$f_{chip, IEEE 802.15.4}$	Chip rate in IEEE 802.15.4 mode		2000		kchip/s

### 5.3.2. Radio Current Consumption (Transmitter)

Symbol	Description	Min.	Typ.	Max.	Units
$I_{TX,PLUS4dBm,DCDC}$	TX only run current (DC/DC, 3 V) $P_{RF} = +4$ dBm		7.0		mA
$I_{TX,PLUS4dBm}$	TX only run current $P_{RF} = +4$ dBm		15.4		mA
$I_{TX,0dBm,DCDC}$	TX only run current (DC/DC, 3 V) $P_{RF} = 0$ dBm		4.6		mA
$I_{TX,0dBm}$	TX only run current $P_{RF} = 0$ dBm		10.1		mA
$I_{TX,MINUS4dBm,DCDC}$	TX only run current DC/DC, 3 V $P_{RF} = -4$ dBm		3.6		mA
$I_{TX,MINUS4dBm}$	TX only run current $P_{RF} = -4$ dBm		7.8		mA
$I_{TX,MINUS8dBm,DCDC}$	TX only run current DC/DC, 3 V $P_{RF} = -8$ dBm		3.2		mA
$I_{TX,MINUS8dBm}$	TX only run current $P_{RF} = -8$ dBm		6.8		mA
$I_{TX,MINUS12dBm,DCDC}$	TX only run current DC/DC, 3 V $P_{RF} = -12$ dBm		2.9		mA
$I_{TX,MINUS12dBm}$	TX only run current $P_{RF} = -12$ dBm		6.2		mA
$I_{TX,MINUS16dBm,DCDC}$	TX only run current DC/DC, 3 V $P_{RF} = -16$ dBm		2.7		mA
$I_{TX,MINUS16dBm}$	TX only run current $P_{RF} = -16$ dBm		5.7		mA
$I_{TX,MINUS20dBm,DCDC}$	TX only run current DC/DC, 3 V $P_{RF} = -20$ dBm		2.5		mA
$I_{TX,MINUS20dBm}$	TX only run current $P_{RF} = -20$ dBm		5.4		mA
$I_{TX,MINUS40dBm,DCDC}$	TX only run current DC/DC, 3 V $P_{RF} = -40$ dBm		2.1		mA
$I_{TX,MINUS40dBm}$	TX only run current $P_{RF} = -40$ dBm		4.3		mA
$I_{START,TX,DCDC}$	TX start-up current DC/DC, 3 V, $P_{RF} = 4$ dBm	..	..	..	mA
$I_{START,TX}$	TX start-up current, $P_{RF} = 4$ dBm	..	..	..	mA



### 5.3.3. Radio Current Consumption (Receiver)

Symbol	Description	Min.	Typ.	Max.	Units
$I_{RX,1M,DCDC}$	RX only run current (DC/DC, 3 V) 1 Mbps/1 Mbps BLE		4.6		mA
$I_{RX,1M}$	RX only run current (LDO, 3 V) 1 Mbps/1 Mbps BLE		10.0		mA
$I_{RX,2M,DCDC}$	RX only run current (DC/DC, 3 V) 2 Mbps/2 Mbps BLE		5.2		mA
$I_{RX,2M}$	RX only run current (LDO, 3 V) 2 Mbps/2 Mbps BLE		11.2		mA
$I_{START,RX,1M,DCDC}$	RX start-up current (DC/DC, 3 V) 1 Mbps/1 Mbps BLE		3.5		mA
$I_{START,RX,1M}$	RX start-up current 1 Mbps/1 Mbps BLE		6.7		mA

### 5.3.4. Transmitter Specification

Symbol	Description	Min.	Typ.	Max.	Units
$P_{RF}$	Maximum output power		4.0		dBm
$P_{RFC}$	RF power control range		24		dB
$P_{RFCR}$	RF power accuracy			$\pm 4$	dB
$P_{RF1,1}$	1st Adjacent Channel Transmit Power 1 MHz (1 Mbps)		-25		dBc
$P_{RF2,1}$	2nd Adjacent Channel Transmit Power 2 MHz (1 Mbps)		-50		dBc
$P_{RF1,2}$	1st Adjacent Channel Transmit Power 2 MHz (2 Mbps)		-25		dBc
$P_{RF2,2}$	2nd Adjacent Channel Transmit Power 4 MHz (2 Mbps)		-50		dBc
$E_{vm}$	Error vector magnitude IEEE 802.15.4		12		%rms
$P_{harm2nd, IEEE 802.15.4}$	2nd harmonics in IEEE 802.15.4 mode		-45		dBm
$P_{harm3rd, IEEE 802.15.4}$	3rd harmonics in IEEE 802.15.4				dBm

### 5.3.5. Receiver Operation

Symbol	Description	Min.	Typ.	Max.	Units
$P_{RX,MAX}$	Maximum received signal strength at < 0.1% PER		0		dBm
$P_{SENS,IT,1M}$	Sensitivity, 1 Mbps nRF mode ideal transmitter <sup>1</sup>		-94		dBm
$P_{SENS,IT,2M}$	Sensitivity, 2 Mbps nRF mode ideal transmitter <sup>2</sup>		-91		dBm
$P_{SENS,IT,SP,1M,BLE}$	Sensitivity, 1 Mbps BLE ideal transmitter, packet length $\leq 37$ bytes BER= $1E-3^3$		-97		dBm
$P_{SENS,IT,LP,1M,BLE}$	Sensitivity, 1 Mbps BLE ideal transmitter, packet length $\geq 128$ bytes BER= $1E-4^4$		-96		dBm

Symbol	Description	Min.	Typ.	Max.	Units
P <sub>SENS,IT,SP,2M,BLE</sub>	Sensitivity, 2 Mbps BLE ideal transmitter, packet length ≤ 37 bytes		-94		dBm
P <sub>SENS,IT,BLE LE125k</sub>	Sensitivity, 125 kbps BLE mode		-104		dBm
P <sub>SENS,IT,BLE LE500k</sub>	Sensitivity, 500 kbps BLE mode		-100		dBm
P <sub>SENS,IEEE 802.15.4</sub>	Sensitivity in IEEE 802.15.4 mode		-101		dBm

1. Typical sensitivity applies when ADDR0 is used for receiver address correlation. When ADDR[1...7] are used for receiver address correlation, the typical sensitivity for this mode is degraded by 3 dB.
2. Same as remark 1.
3. As defined in the Bluetooth Core Specification v4.0 Volume 6: Core System Package (Low Energy Controller Volume)
4. Equivalent BER limit < 10E-04.

### 5.3.6. RX Selectivity

Symbol	Description	Min.	Typ.	Max.	Units
C/I <sub>1M,co-channel</sub>	1Mbps mode, Co-Channel interference		9		dB
C/I <sub>1M,-1MHz</sub>	1 Mbps mode, Adjacent (-1 MHz) interference		-2		dB
C/I <sub>1M,+1MHz</sub>	1 Mbps mode, Adjacent (+1 MHz) interference		-10		dB
C/I <sub>1M,-2MHz</sub>	1 Mbps mode, Adjacent (-2 MHz) interference		-19		dB
C/I <sub>1M,+2MHz</sub>	1 Mbps mode, Adjacent (+2 MHz) interference		-42		dB
C/I <sub>1M,-3MHz</sub>	1 Mbps mode, Adjacent (-3 MHz) interference		-38		dB
C/I <sub>1M,+3MHz</sub>	1 Mbps mode, Adjacent (+3 MHz) interference		-48		dB
C/I <sub>1M,±6MHz</sub>	1 Mbps mode, Adjacent (≥6 MHz) interference		-50		dB
C/I <sub>1MBLE,co-channel</sub>	1 Mbps BLE mode, Co-Channel interference		6		dB
C/I <sub>1MBLE,-1MHz</sub>	1 Mbps BLE mode, Adjacent (-1 MHz) interference		-2		dB
C/I <sub>1MBLE,+1MHz</sub>	1 Mbps BLE mode, Adjacent (+1 MHz) interference		-9		dB
C/I <sub>1MBLE,-2MHz</sub>	1 Mbps BLE mode, Adjacent (-2 MHz) interference		-22		dB
C/I <sub>1MBLE,+2MHz</sub>	1 Mbps BLE mode, Adjacent (+2 MHz) interference		-46		dB
C/I <sub>1MBLE,&gt;3MHz</sub>	1 Mbps BLE mode, Adjacent (≥3 MHz) interference		-50		dB
C/I <sub>1MBLE,image</sub>	Image frequency interference		-22		dB
C/I <sub>1MBLE,image,1MHz</sub>	Adjacent (1 MHz) interference to in-band image frequency		-35		dB
C/I <sub>2M,co-channel</sub>	2 Mbps mode, Co-Channel interference		10		dB
C/I <sub>2M,-2MHz</sub>	2 Mbps mode, Adjacent (-2 MHz) interference		6		dB
C/I <sub>2M,+2MHz</sub>	2 Mbps mode, Adjacent (+2 MHz) interference		-14		dB
C/I <sub>2M,-4MHz</sub>	2 Mbps mode, Adjacent (-4 MHz) interference		-20		dB
C/I <sub>2M,+4MHz</sub>	2 Mbps mode, Adjacent (+4 MHz) interference		-44		dB
C/I <sub>2M,-6MHz</sub>	2 Mbps mode, Adjacent (-6 MHz) interference		-42		dB
C/I <sub>2M,+6MHz</sub>	2 Mbps mode, Adjacent (+6 MHz) interference		-47		dB
C/I <sub>2M,≥12MHz</sub>	2 Mbps mode, Adjacent (≥12 MHz) interference		-52		dB

Symbol	Description	Min.	Typ.	Max.	Units
C/I <sub>2M</sub> BLE,co-channel	2 Mbps BLE mode, Co-Channel interference		6		dB
C/I <sub>2M</sub> BLE,±2MHz	2 Mbps BLE mode, Adjacent (±2 MHz) interference		-2		dB
C/I <sub>2M</sub> BLE,±4MHz	2 Mbps BLE mode, Adjacent (±4 MHz) interference		-48		dB
C/I <sub>2M</sub> BLE,≥6MHz	2 Mbps BLE mode, Adjacent (≥6 MHz) interference		-50		dB
C/I <sub>2M</sub> BLE,image	Image frequency interference		-29		dB
C/I <sub>2M</sub> BLE,image, 2MHz	Adjacent (2 MHz) interference to in-band image frequency		-44		dB
C/I <sub>125k</sub> BLE LR,co-channel	125 kbps BLE LR mode, Co-Channel interference		4		dB
C/I <sub>125k</sub> BLE LR,-1MHz	125 kbps BLE LR mode, Adjacent (-1 MHz) interference		-9		dB
C/I <sub>125k</sub> BLE LR,+1MHz	125 kbps BLE LR mode, Adjacent (+1 MHz) interference		-16		dB
C/I <sub>125k</sub> BLE LR,-2MHz	125 kbps BLE LR mode, Adjacent (-2 MHz) interference		-30		dB
C/I <sub>125k</sub> BLE LR,+2MHz	125 kbps BLE LR mode, Adjacent (+2 MHz) interference		-50		dB
C/I <sub>125k</sub> BLE LR,>3MHz	125 kbps BLE LR mode, Adjacent (≥3 MHz) interference		-55		dB
C/I <sub>125k</sub> BLE LR,image	Image frequency interference		-30		dB
C/I <sub>IEEE 802.15.4,-5MHz</sub>	IEEE 802.15.4 mode, Adjacent (-5 MHz) rejection		33		dB
C/I <sub>IEEE 802.15.4,+5MHz</sub>	IEEE 802.15.4 mode, Adjacent (+5 MHz) rejection		38		dB
C/I <sub>IEEE 802.15.4, 10MHz </sub>	IEEE 802.15.4 mode, Alternate (10 MHz) rejection		48		dB

### 5.3.7. RX Intermodulation

Symbol	Description	Min.	Typ.	Max.	Units
P <sub>IMD,5TH,1M</sub>	IMD performance, 1 Mbps, 5th offset channel, packet length ≤ 37 bytes		-33		dBm
P <sub>IMD,5TH,1M,BLE</sub>	IMD performance, BLE 1 Mbps, 5th offset channel, packet length ≤ 37 bytes		-30		dBm
P <sub>IMD,5TH,2M</sub>	IMD performance, 2 Mbps, 5th offset channel, packet length ≤ 37 bytes		-33		dBm
P <sub>IMD,5TH,2M,BLE</sub>	IMD performance, BLE 2 Mbps, 5th offset channel, packet length ≤ 37 bytes		-31		dBm

Remark: Desired signal level at PIN= -64 dBm. Two interferers with equal input power are used. The interferer closest in frequency is not modulated, the other interferer is modulated equal with the desired signal. The input power of the interferers where the sensitivity equals BER = 0.1% is presented.

### 5.3.8. RSSI Specifications

Symbol	Description	Min.	Typ.	Max.	Units
RSSI <sub>ACC</sub>	RSSI accuracy valid range -90 to -20 dBm		±2		dB
RSSI <sub>RESOLUTION</sub>	RSSI resolution		1		dB
RSSI <sub>PERIOD</sub>	RSSI sampling time from RSSI_START task		0.25		µs
RSSI <sub>SETTLE</sub>	RSSI settling time after signal level change		15		µs

## 5.3.9. Radio Timing Parameters

Symbol	Description	Min.	Typ.	Max.	Units
t <sub>TXEN,BLE,1M</sub>	Time between TXEN task and READY event after channel FREQUENCY configured (1 Mbps BLE and 150 μs TIFS)	140		140	μs
t <sub>TXEN,FAST,BLE,1M</sub>	Time between TXEN task and READY event after channel FREQUENCY configured (1 Mbps BLE with fast ramp-up and 150 μs TIFS)	40		40	μs
t <sub>TXDIS,BLE,1M</sub>	When in TX, delay between DISABLE task and DISABLED event for MODE = Nrf_1Mbit and MODE = Ble_1Mbit	6		6	μs
t <sub>RXEN,BLE,1M</sub>	Time between the RXEN task and READY event after channel FREQUENCY configured (1 Mbps BLE)	140		140	μs
t <sub>RXEN,FAST,BLE,1M</sub>	Time between the RXEN task and READY event after channel FREQUENCY configured (1 Mbps BLE with fast ramp-up)	40		40	μs
t <sub>RXDIS,BLE,1M</sub>	When in RX, delay between DISABLE task and DISABLED event for MODE = Nrf_1Mbit and MODE = Ble_1Mbit	0		0	μs
t <sub>TXDIS,BLE,2M</sub>	When in TX, delay between DISABLE task and DISABLED event for MODE = Nrf_2Mbit and MODE = Ble_2Mbit	4		4	μs
t <sub>RXDIS,BLE,2M</sub>	When in RX, delay between DISABLE task and DISABLED event for MODE = Nrf_2Mbit and MODE = Ble_2Mbit	0		0	μs
t <sub>TXEN,IEEE 802.15.4</sub>	Time between TXEN task and READY event after channel FREQUENCY configured (IEEE 802.15.4)	130		130	μs
t <sub>TXEN,FAST,IEEE 802.15.4</sub>	Time between TXEN task and READY event after channel FREQUENCY configured (IEEE 802.15.4 with fast ramp-up)	40		40	μs
t <sub>TXDIS,IEEE 802.15.4</sub>	When in TX, delay between DISABLE task and DISABLED event (IEEE 802.15.4)	21		21	μs
t <sub>RXEN,IEEE 802.15.4</sub>	Time between the RXEN task and READY event after channel FREQUENCY configured (IEEE 802.15.4)	130		130	μs
t <sub>RXEN,FAST,IEEE 802.15.4</sub>	Time between the RXEN task and READY event after channel FREQUENCY configured (IEEE 802.15.4 with fast ramp-up)	40		40	μs
t <sub>RXDIS,IEEE 802.15.4</sub>	When in RX, delay between DISABLE task and DISABLED event (IEEE 802.15.4)	0.5		0.5	μs
t <sub>RX-to-TX turnaround</sub>	Maximum TX-to-RX or RX-to-TX turnaround time in IEEE 802.15.4 mode		40		μs

## 5.3.10. CPU

Symbol	Description	Min.	Typ.	Max.	Units
W <sub>FLASH</sub>	CPU wait states, running from flash	0		2	
W <sub>RAM</sub>	CPU wait states, running from RAM			0	
CM <sub>FLASH</sub>	CoreMark <sup>1</sup> , running from flash		144		CoreMark
CM <sub>FLASH/MHz</sub>	CoreMark per MHz, running from flash		2.25		Corel MHz
CM <sub>FLASH/mA</sub>	CoreMark per mA, running from flash, DCDC 3V		65		CoreMark/mA

## 5.3.11. Power Management

Symbol	Description	Min.	Typ.	Max.	Units
I <sub>ON_RAMOFF_EVENT</sub>	System ON, No RAM retention, Wake on any event		0.6		μA
I <sub>ON_RAMON_EVENT</sub>	System ON, Full 24 kB RAM retention, Wake on any event		0.8		μA
I <sub>ON_RAMON_POF</sub>	System ON, Full 24 kB RAM retention, Wake on any event, Power fail comparator enabled		0.8		μA
I <sub>ON_RAMON_GPIOTE</sub>	System ON, Full 24 kB RAM retention, Wake on GPIOTE input (Event mode)		3.3		μA
I <sub>ON_RAMON_GPIOTEPORT</sub>	System ON, Full 24 kB RAM retention, Wake on GPIOTE PORT event		0.8		μA
I <sub>ON_RAMON_RTC</sub>	System ON, Full 24 kB RAM retention, Wake on RTC (running from LFRC clock)		1.5		μA
I <sub>ON_RAMOFF_RTC</sub>	System ON, No RAM retention, Wake on RTC (running from LFRC clock)		1.4		μA
I <sub>ON_RAMON_RTC_LFXO</sub>	System ON, Full 24 kB RAM retention, Wake on RTC (running from LFXO clock)		1.1		μA
I <sub>ON_RAMOFF_RTC_LFXO</sub>	System ON, No RAM retention, Wake on RTC (running from LFXO clock)		1.0		μA
I <sub>OFF_RAMOFF_RESET</sub>	System OFF, No RAM retention, Wake on reset		0.3		μA
I <sub>OFF_RAMON_RESET</sub>	System OFF, Full 24 kB RAM retention, Wake on reset		0.5		μA

# 6. Block Diagram

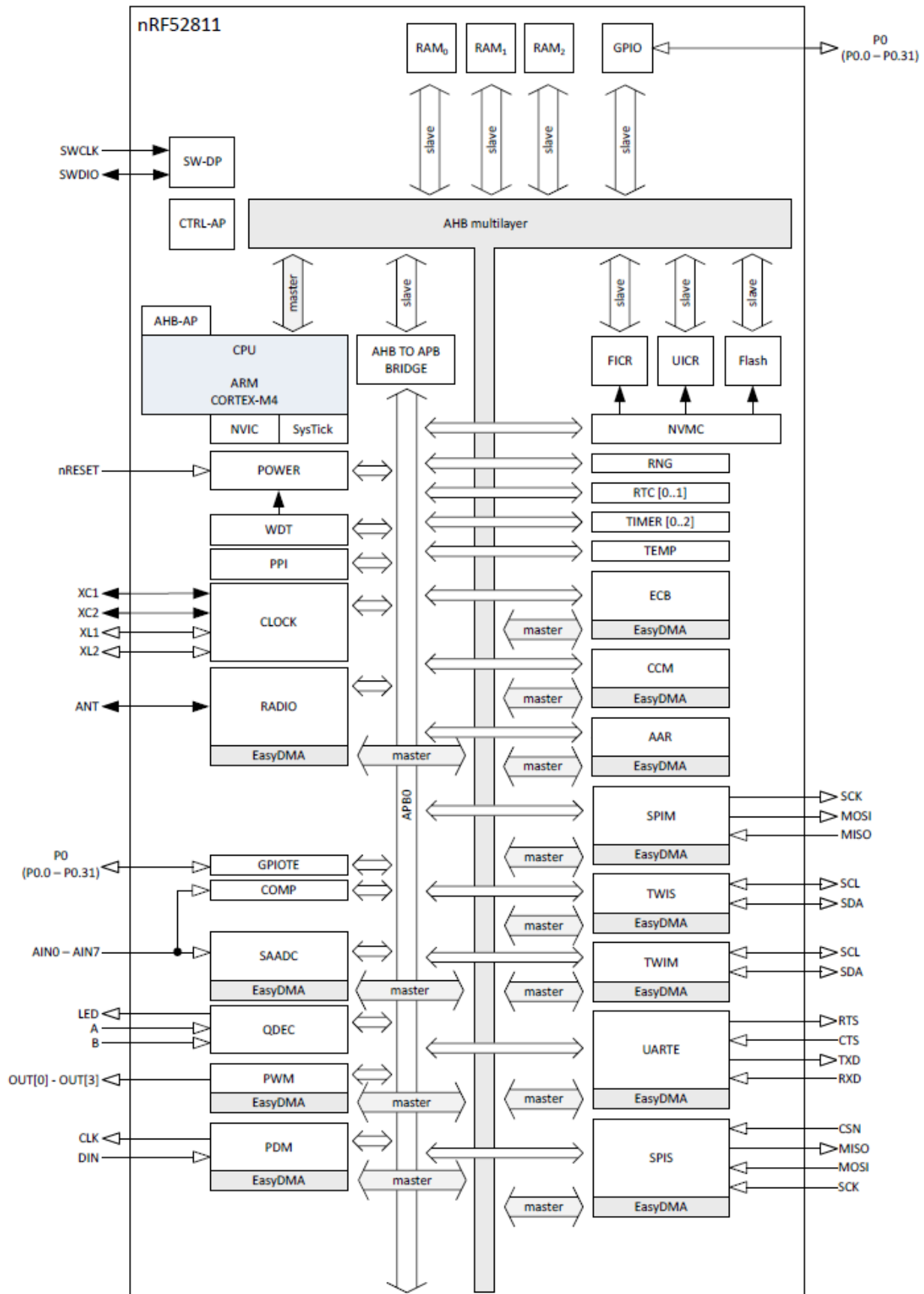

# 7. Antenna

## 7.1. MDBT42Q Series

### Test Result

Frequency (MHz)	2400	2410	2420	2430	2440	2450	2460	2470	2480	2490	2500
Gain (dBi)	-3.68	-2.91	-2.34	-1.98	-1.66	-1.60	-1.77	-2.09	-2.60	-3.35	-4.10
Peak EIRP (dBm)	-3.68	-2.91	-2.34	-1.98	-1.66	-1.60	-1.77	-2.09	-2.60	-3.35	-4.10
Directivity (dBi)	4.98	5.11	5.12	5.02	4.93	4.76	4.58	4.38	4.11	3.77	3.42

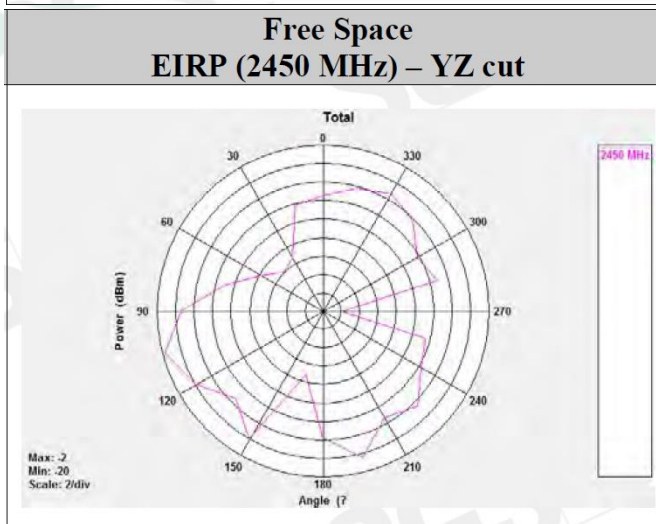
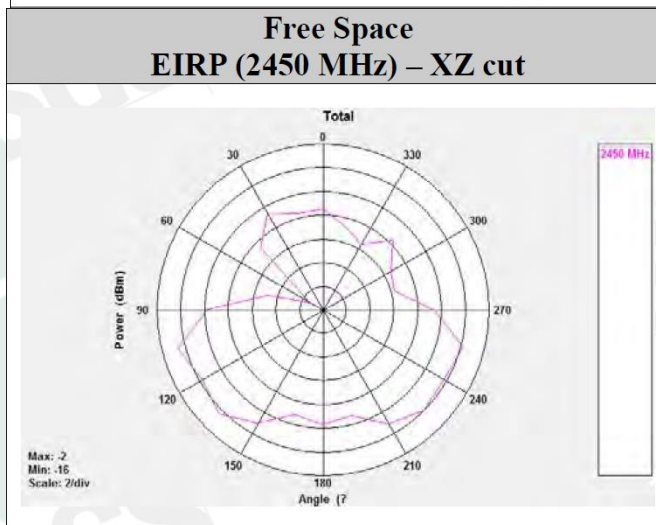
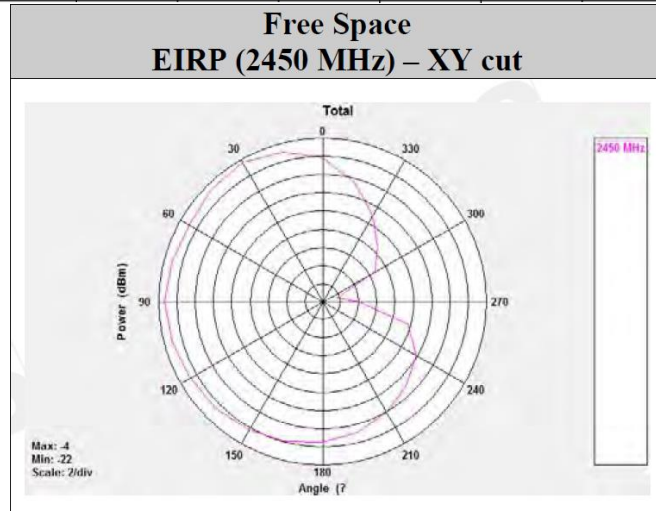

## 7.2. MDBT42Q-P Series

### Test Result

Frequency (MHz)	2400	2410	2420	2430	2440	2450	2460	2470	2480	2490	2500
Gain (dBi)	-3.87	-3.06	-2.31	-2.01	-2.04	-2.31	-2.24	-1.96	-1.61	-1.71	-1.97
Peak EIRP (dBm)	-3.87	-3.06	-2.31	-2.01	-2.04	-2.31	-2.24	-1.96	-1.61	-1.71	-1.97
Directivity (dBi)	3.79	4.00	4.25	4.17	3.86	3.51	3.54	3.91	4.39	4.44	4.49

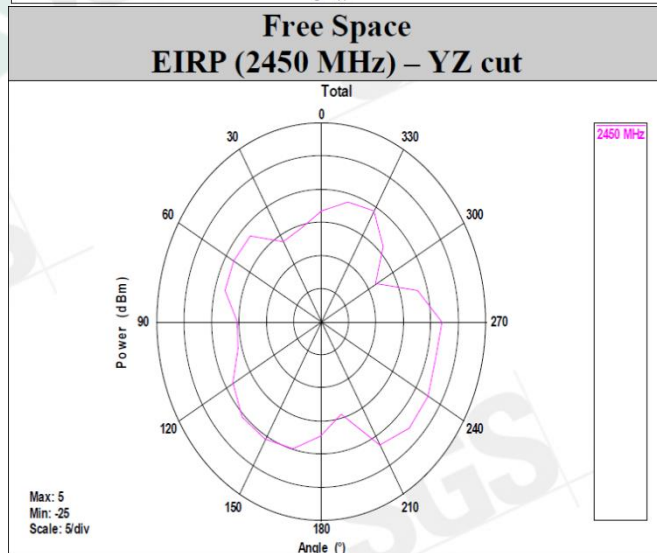
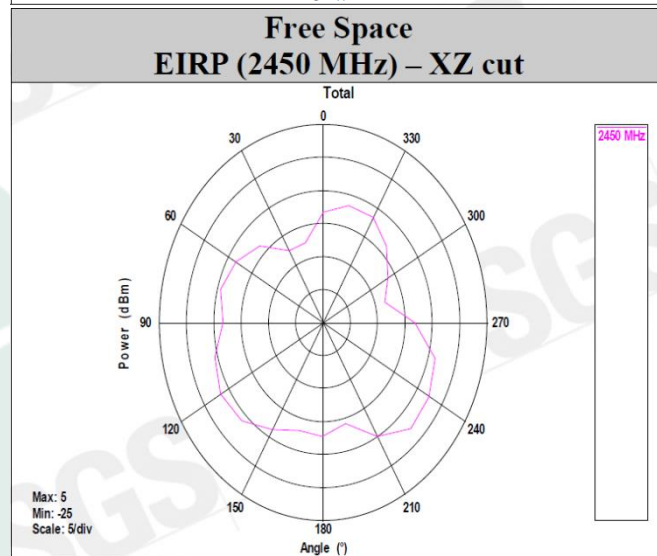
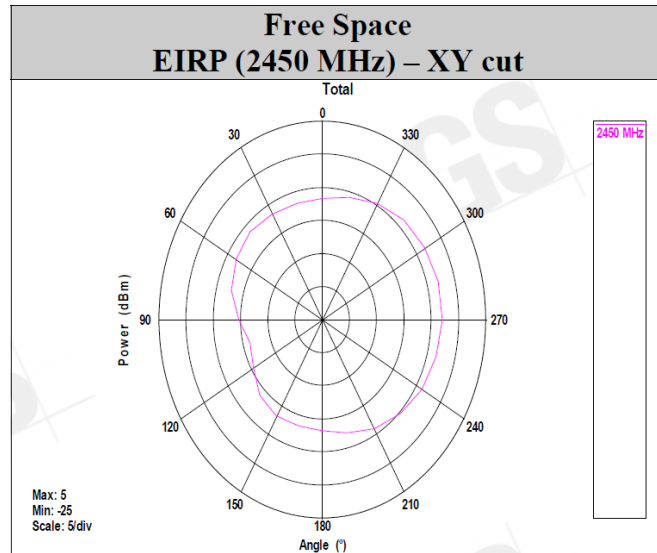



# 8. Reference Circuit

Module is pre-programmed with Raytac's testing code. Default is using "LDO mode". Our firmware is set to use external 32.768khz so please add it to make module work.

**REMARK:**

**\*\* When using DC-DC mode, please add L2 / L3 / C14. \*\***

**\*\* When using internal 32.768khz RC oscillator, please remove X2 / C12 / C13. \*\***

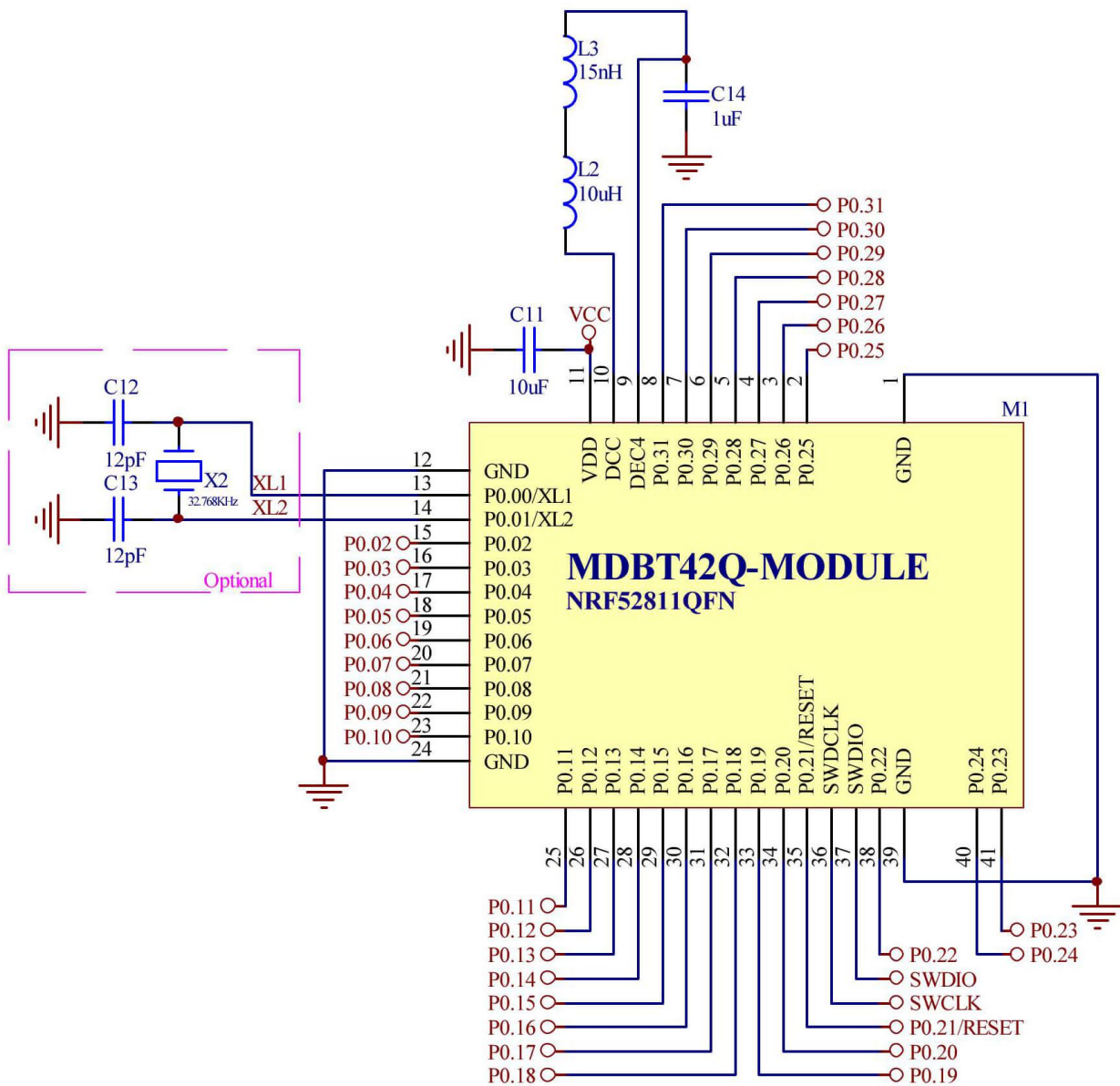

# 9. Certification

## 9.1. Declaration ID

### BT 5.1

Declaration ID	QDID(s)	Company	Specification Name
D047708	139361 - End Product	Raytac Corporation	5.1

### BT 5.2

Declaration ID	QDID(s)	Company	Specification Name
D053149	159932 - End Product	Raytac Corporation	5.2



Profile Description	Service Description
Alert Notification Profile	Alert Notification Service
Blood Pressure Profile	Blood Pressure Service
	Device Information Service
Cycling Speed & Cadence Profile	Cycling Speed & Cadence Service
	Device Information Service
Glucose Profile	Glucose Service
	Device Information Service
Health Thermometer Profile	Health Thermometer Service
	Device Information Service
Heart Rate Profile	Heart Rate Service
	Device Information Service
HID over GATT Profile	HID Service
	Battery Service
Proximity Profile	Link Loss Service
	Immediate Alert Service
	TX Power Service
Running Speed & Cadence Profile	Running Speed & Cadence Service
	Device Information Service
Time Profile	Time Profile Service
Glucose Profile (Central)	
Mesh Profile	Mesh Provisioning Service
	Mesh Proxy Service

## 9.2. FCC Certificate (USA)

**BLE 1 Mbps**



**telefication**

**TCB**

**GRANT OF EQUIPMENT  
AUTHORIZATION**

Certification  
Issued Under the Authority of the  
Federal Communications Commission

By:

Telefication B.V.  
Edisonstraat 12a  
Zevenaar, NL-6902 PK  
Netherlands

**TCB**

Raytac Corp.  
5F., No.3, Jiankang Rd., Zhonghe Dist.,  
New Taipei City,, 23586  
Taiwan

Attention: Venson Liao , R&D Manager

Date of Grant: 01/02/2018

Application  
Dated: 12/18/2017

**NOT TRANSFERABLE**

EQUIPMENT AUTHORIZATION is hereby issued to the named  
GRANTEE, and is VALID ONLY for the equipment identified hereon for  
use under the Commission's Rules and Regulations listed below.

FCC IDENTIFIER:	SH6MDBT42Q		
Name of Grantee:	Raytac Corp.		
Equipment Class:	Digital Transmission System		
Notes:	BLE Module		
Modular Type:	Single Modular		

Grant Notes	FCC Rule Parts	Frequency Range (MHZ)	Output Watts	Frequency Emission Tolerance Designator
	15C	2402.0 - 2480.0	0.0023	

C2PC: add BT5.0 by Firmware and change product name to BLE module from BT 4.2 module. To change module to be certified under portable device.  
Power output listed is conducted. This grant is valid only when the module is sold to OEM integrators and must be installed by the OEM or OEM integrators. The antenna's as listed in this application must not be co-located or operating in conjunction with any other antenna or transmitter. End-users may not be provided with the module installation instructions. OEM integrators and end-users must be provided with transmitter operating conditions for satisfying RF exposure compliance.

Certificate No.: 162181172/AA/02	George Lo Product Assessor	
-------------------------------------	-------------------------------	---

# BLE 2 Mbps



TCB

## GRANT OF EQUIPMENT AUTHORIZATION

TCB

Certification  
Issued Under the Authority of the  
Federal Communications Commission  
By:

Telefication B.V.  
Edisonstraat 12a  
Zevenaar, NL-6902 PK  
Netherlands

Date of Grant: 01/02/2018

Application  
Dated: 12/18/2017

Raytac Corp.  
5F., No.3, Jiankang Rd., Zhonghe Dist.,  
New Taipei City., 23586  
Taiwan

Attention: Venson Liao , R&D Manager

### NOT TRANSFERABLE

EQUIPMENT AUTHORIZATION is hereby issued to the named GRANTEE, and is VALID ONLY for the equipment identified hereon for use under the Commission's Rules and Regulations listed below.

FCC IDENTIFIER: SH6MDBT42Q  
Name of Grantee: Raytac Corp.  
Equipment Class: Digital Transmission System  
Notes: BLE Module  
Modular Type: Single Modular

Grant Notes	FCC Rule Parts	Frequency Range (MHZ)	Output Watts	Frequency Tolerance	Emission Designator
	15C	2402.0 - 2480.0	0.0023		

C2PC: add BT5.0 by Firmware and change product name to BLE module from BT 4.2 module. To change module to be certified under portable device.

Power output listed is conducted. This grant is valid only when the module is sold to OEM integrators and must be installed by the OEM or OEM integrators. The antenna's as listed in this application must not be co-located or operating in conjunction with any other antenna or transmitter. End-users may not be provided with the module installation instructions. OEM integrators and end-users must be provided with transmitter operating conditions for satisfying RF exposure compliance.

Certificate No.: 162181172/AA/02	George Lo Product Assessor	
-------------------------------------	-------------------------------	---

## 9.3. TELEC Certificate (Japan)

**BLE 1 Mbps**

telefication bv  
The Netherlands  
Chamber of Commerce  
51565536  
www.telefication.com



**telefication**

**Certificate**  
of  
Radio Equipment in JAPAN

No: 201-160496 / 00

Telefication, operating as Conformity Assessment Body (CAB ID Number: 201) with respect to Japan, declares that the listed product complies with the Technical Regulations Conformity Certification of Terminal equipment (ordinance of MPT N° 31,1984)

Product description: **BT 4.2 Module**  
Trademark: **Raytac**  
Type designation: **MDBT42Q**  
Hardware / Software version: **1 / 1**  
Variants: **See Annex 3**

Manufacturer: **Raytac Corporation**  
Address: **5F, No.3, Jiankang Rd., Zhonghe Dist.,**  
City: **New Taipei 23586**  
Country: **Taiwan**

This statement is granted to:

Name: **Raytac Corporation**  
Address: **5F, No.3, Jiankang Rd., Zhonghe Dist.,**  
City: **New Taipei 23586**  
Country: **Taiwan**

This statement has **THREE** Annexes.

Zevenaar, 19 August 2016

**CAB**



Ramy Nabod  
Product Assessor



**PRODUCTS**  
**RvA C 224**

## BLE 2 Mbps

telefication bv  
The Netherlands  
Chamber of Commerce  
51565536  
www.telefication.com



### Certificate of Radio Equipment in JAPAN

No: 201-160496 / 02

Telefication, operating as Conformity Assessment Body (CAB ID Number: 201) with respect to Japan, declares that the listed product complies with the Technical Regulations Conformity Certification of Specified Radio equipment (ordinance of MPT N° 37,1981)

Product description: **BLE Module**  
Trademark: **Raytac**  
Type designation: **MDBT42Q**  
Hardware / Software version: **1 / 1**  
Variants: **See Annex 3**

Manufacturer: **Raytac Corporation**  
Address: **5F, No. 3, Jiankang Rd., Zhonghe Dist.**  
City: **23586 New Taipei City**  
Country: **Taiwan**

This certificate is granted to:

Name: **Raytac Corporation**  
Address: **5F, No. 3, Jiankang Rd., Zhonghe Dist.**  
City: **23586 New Taipei City**  
Country: **Taiwan**

This certificate has **THREE** Annexes.

Zevenaar, 23 May 2019

**CAB**

*David Chen*

David Chen  
Product Assessor



## 9.4. NCC Certificate (Taiwan)

### MDBT42Q Series

**BLE 1 Mbps & 2 Mbps**

#### 國家通訊傳播委員會 電信管制射頻器材型式認證證明

- 一、申請者：勁達國際電子有限公司
- 二、地址：臺北市大安區和平東路1段145號5樓之1
- 三、製造廠商：勁達國際電子有限公司
- 四、器材名稱：BLE Module
- 五、廠牌：Raytac
- 六、型號：MDBT42Q
- 七、發射功率(電場強度)：詳細射頻規格如備註欄
- 八、工作頻率：詳細射頻規格如備註欄
- 九、審驗日期：105年08月19日(換證日期：108年06月19日)

十、審驗合格標籤式樣：

CCAM16LP1180T2



十一、警語或標示要求：(器材本體、使用手冊、外包裝盒等應遵守下列標示要求)

1. 應依審驗合格標籤或符合性聲明標籤式樣自製標籤黏貼或印鑄於電信管制射頻器材本體明顯處，並於包裝盒標示本會標章，始得開陳列或販賣。
2. 電信管制射頻器材應依本會或相關技術規範規定於指定位置標示中文警語。
3. 經授權使用射頻模組(組件)之審驗合格標籤者，應於最終產品說明書及包裝盒提供充分與正確之資訊。
4. 於網際網路販賣取得審驗證明之電信管制射頻器材者，應於該網際網路網頁提供審驗合格標籤或符合性聲明標籤資訊。
5. 使用手冊應標示下列資訊：
  - (1)經型式認證合格之低功率射頻電機，非經許可，公司、商號或使用者均不得擅自變更頻率、加大功率或變更原設計之特性及功能。低功率射頻電機之使用不得影響飛航安全及干擾合法通信；經發現有干擾現象時，應立即停用，並改善至無干擾時方得繼續使用。前項合法通信，指依電信法規定作業之無線電通信。低功率射頻電機須忍受合法通信或工業、科學及醫療用電波輻射性電機設備之干擾。
6. 本器材之審驗範圍僅限無線射頻硬體功能，不及於器材之資通安全檢測。

型式認證號碼：CCAM16LP1180T2

第 1 頁，共 2 頁

本證書與續頁分別使用無效



## MDBT42Q-P Series

**BLE 1 Mbps & 2 Mbps**

### 國家通訊傳播委員會 電信管制射頻器材型式認證證明

- 一、申請者：勁達國際電子有限公司
- 二、地址：臺北市大安區和平東路1段145號5樓之1
- 三、製造廠商：勁達國際電子有限公司
- 四、器材名稱：BLE Module
- 五、廠牌：Raytac
- 六、型號：MDBT42Q-P
- 七、發射功率(電場強度)：詳細射頻規格如備註欄
- 八、工作頻率：詳細射頻規格如備註欄
- 九、審驗日期：105年08月19日(換證日期：108年06月19日)

- 十、審驗合格標籤式樣：



- 十一、警語或標示要求：(器材本體、使用手冊、外包装盒等應遵守下列標示要求)
1. 應依審驗合格標籤或符合性聲明標籤式樣自製標籤黏貼或印鑄於電信管制射頻器材本體明顯處，並於包装盒標示本會標章，始得開陳列或販賣。
  2. 電信管制射頻器材應依本會或相關技術規範規定於指定位置標示中文警語。
  3. 經授權使用射頻模組(組件)之審驗合格標籤者，應於最終產品說明書及包装盒提供充分與正確之資訊。
  4. 於網際網路販售取得審驗證明之電信管制射頻器材者，應於該網際網路網頁提供審驗合格標籤或符合性聲明標籤資訊。
  5. 使用手冊應標示下列資訊：  
(1)經型式認證合格之低功率射頻電機，非經許可，公司、商號或使用者均不得擅自變更頻率、加大功率或變更原設計之特性及功能。低功率射頻電機之使用不得影響飛航安全及干擾合法通信；經發現有干擾現象時，應立即停用，並改善至無干擾時方得繼續使用。前項合法通信，指依電信法規定作業之無線電通信。低功率射頻電機須忍受合法通信或工業、科學及醫療用電波輻射性電機設備之干擾。
  6. 本器材之審驗範圍僅限無線射頻硬體功能，不及於器材之資通安全檢測。

## 9.5. CE Test Report (EU)

**BLE 1 Mbps & 2 Mbps**

**SGS**

SGS Reference No: MH/2019/40103C

**VERIFICATION OF EMC COMPLIANCE**

Verification No. : MH/2019/40103C  
Representative Model No. : MDBT42Q  
Added Model(s) : MDBT42Q-P, MDBT42Q-U  
Product Name : BLE Module  
Brand Name : Raytac  
Applicant : Raytac Corporation  
Address of Applicant : 5F, No.3, Jiankang Rd., Zhonghe Dist., New Taipei City , 23586, Taiwan  
Test Report Number : MH/2019/40103  
Date of Issue : May 13, 2019  
Applicable Standards : EN 301 489 –1 v2.2.0 : 2017-03 (Draft)  
EN 301 489 –17 v3.2.0 : 2017-03 (Draft)  
EN 55032 : 2015+AC:2016-07  
EN 61000-4-2 : 2009, EN 61000-4-3 : 2006+A1:2008+A2:2010

**Conclusion**  
The apparatus meets the requirements of the above standards and hence compliance the essential requirements under article 3.1b of the RED (2014/53/EU) Directive.

\*This verification is only valid for the equipment and configuration described, and in conjunction with the test report as detailed above.

Authorized Signatory:  
*Eddy Cheng*

SGS TAIWAN LTD.  
Eddy Cheng  
Technical Asst. Supervisor



**RED (2014/53/EU)**  
**ETSI EN 300 328 v2.2.2 : 2019**  
**TEST REPORT**

FOR

**Applicant:** Raytac Corporation  
5F, No.3, Jiankang Rd., Zhonghe Dist., New Taipei City ,  
23586, Taiwan

**Product Name:** BLE Module

**Brand Name:** Raytac

**Model No.:** MDBT42Q, MDBT42Q-P

**Model Difference:** MDBT42Q with Chip antenna,  
MDBT42Q-P with PCB antenna

**Report Number:** ER/2016/70008-05

**Issue Date:** May 15, 2020

**Date of Test:** Jul. 04, 2016 ~ Nov. 28, 2017 (Original)  
Apr. 16, 2020 ~May 04, 2020 (Updated)

**Date of EUT Received:** Jul. 04, 2016 (Original)  
Apr. 16, 2020(Updated)

**We hereby certify that:**

The above equipment was tested by SGS Taiwan Ltd., Electronics & Communication Laboratory for compliance with the requirements set forth in the European Standard ETSI EN 300 328 v2.2.2: 2019 under RED 2014/53/EU. The results of testing in this report apply to the product system that was tested only. Other similar equipment will not necessarily produce the same results due to production tolerance and measurement uncertainties.

Approved By: \_\_\_\_\_

CHUN-CHIEH CHEN  
 Chun Chieh Chen / Supervisor



## 9.6. IC Certificate (Canada)

**BLE 1 Mbps**

<p>telefication bv The Netherlands Chamber of Commerce 51565536 www.telefication.com</p>			
<p><b>TECHNICAL ACCEPTANCE CERTIFICATE</b></p>		<p><b>CERTIFICAT D'ACCEPTABILITÉ TECHNIQUE</b></p>	
CERTIFICATION No. No. DE CERTIFICATION	8017A-MDBT42Q		
TELEFICATION No. No. DE TELEFICATION	162170280/AA/01		
TEST SITE No. No. DE LABORATOIRE	4620A-5		
ISSUED TO DÉLIVRÉ A	Raytac Corporation		
TYPE OF EQUIPMENT GENRE DE MATÉRIEL	Bluetooth device		
TRADE NAME AND MODEL MARQUE ET MODELE	Raytac / MDBT42Q Raytac / MDBT42Q-P		
CERTIFIED TO CERTIFIÉ SELON LE	SPECIFICATION CAHIER DES CHARGES	RSS-102 RSS-247	ISSUE EDITION 5 1
<p>Certification of equipment means only that the equipment has met the requirements of the above-noted specification. Licence applications, where applicable to use certified equipment, are acted on accordingly by the Industry Canada issuing office and will depend on the existing radio environment, service and location of operation. This certificate is issued on condition that the holder complies and will continue to comply with the requirements and procedures issued by Industry Canada. The equipment for which this certificate is issued shall not be manufactured, imported, distributed, leased, offered for sale or sold unless the equipment complies with the applicable technical specifications and procedures issued by Industry Canada.</p>		<p>La certification du matériel signifie seulement que le matériel a satisfait aux exigences de la norme indiquée ci-dessus. Les demandes de licences nécessaires pour l'utilisation du matériel certifié sont traitées en conséquence par le bureau de délivrance d'Industrie Canada et dépendent des conditions radio ambiantes, du service et de l'emplacement d'exploitation. Le présent certificat est délivré à la condition que le titulaire satisfasse et continue de satisfaire aux exigences et aux procédures d'Industrie Canada. Le matériel à l'égard duquel le présent certificat est délivré ne doit pas être fabriqué, importé, distribué, loué, mis en vente ou vendu à moins d'être conforme aux procédures et aux spécifications techniques applicables publiées par Industrie Canada.</p>	
<p>ISSUED BY TELEFICATION BV, RECOGNIZED CERTIFICATION BODY BY INDUSTRY CANADA DÉLIVRÉ PAR TELEFICATION BV, ORGANISME DE CERTIFICATION RECONNU PAR INDUSTRIE CANADA</p>			
<p><i>I hereby attest that the subject equipment was tested and found in compliance with the above-noted specification. J'atteste, par la présente, que le matériel a fait l'objet d'essai et a été jugé conforme à la spécification ci-dessus</i></p>			
DATE 21 Feb 2017 BY	Mohammad Elhaj Product Assessor		
<p>This certificate has one annex.</p>			
			

## BLE 2 Mbps

telefication bv  
The Netherlands  
Chamber of Commerce  
51565536  
www.telefication.com



### TECHNICAL ACCEPTANCE CERTIFICATE

### CERTIFICAT D'ACCEPTABILITÉ TECHNIQUE

CERTIFICATION No. No. DE CERTIFICATION	8017A-MDBT42Q
TELEFICATION No. No. DE TELEFICATION	162170280/AA/02
TEST SITE No. No. DE LABORATOIRE	4620A-5
ISSUED TO DELIVRÉ A	Raytac Corporation
TYPE OF EQUIPMENT GENRE DE MATÉRIEL	Bluetooth device
TRADE NAME AND MODEL MARQUE ET MODELE	Raytac / MDBT42Q Raytac / MDBT42Q-P

CERTIFIED TO CERTIFIÉ SELON LE	SPECIFICATION CAHIER DES CHARGES	RSS-102 RSS-247	ISSUE EDITION	5 2
-----------------------------------	-------------------------------------	--------------------	------------------	--------

Certification of equipment means only that the equipment has met the requirements of the above-noted specification. Licence applications, where applicable to use certified equipment, are acted on accordingly by the ISED issuing office and will depend on the existing radio environment, service and location of operation. This certificate is issued on condition that the holder complies and will continue to comply with the requirements and procedures issued by ISED. The equipment for which this certificate is issued shall not be manufactured, imported, distributed, leased, offered for sale or sold unless the equipment complies with the applicable technical specifications and procedures issued by ISED.

La certification du matériel signifie seulement que le matériel a satisfait aux exigences de la norme indiquée ci-dessus. Les demandes de licences nécessaires pour l'utilisation du matériel certifié sont traitées en conséquence par le bureau de délivrance d'ISDE et dépendent des conditions radio ambiantes, du service et de l'emplacement d'exploitation. Le présent certificat est délivré à la condition que le titulaire satisfasse et continue de satisfaire aux exigences et aux procédures d'ISDE. Le matériel à l'égard duquel le présent certificat est délivré ne doit pas être fabriqué, importé, distribué, loué, mis en vente ou vendu à moins d'être conforme aux procédures et aux spécifications techniques applicables publiées par ISDE.

ISSUED BY TELEFICATION BV (NL0001), RECOGNIZED CERTIFICATION BODY BY INNOVATION, SCIENCE AND ECONOMIC DEVELOPMENT CANADA  
DELIVRÉ PAR TELEFICATION BV (NL0001), ORGANISME DE CERTIFICATION RECONNU PAR INNOVATION, SCIENCES ET DÉVELOPPEMENT ÉCONOMIQUE CANADA

*I hereby attest that the subject equipment was tested and found in compliance with the above-noted specification.  
J'atteste, par la présente, que le matériel a fait l'objet d'essai et a été jugé conforme à la spécification ci-dessus*

DATE 02 Jan 2018 BY

George Lo  
Product Assessor

This certificate has one annex.



## 9.7. SRRC Certificate (China)

**BLE 1 Mbps & 2 Mbps**

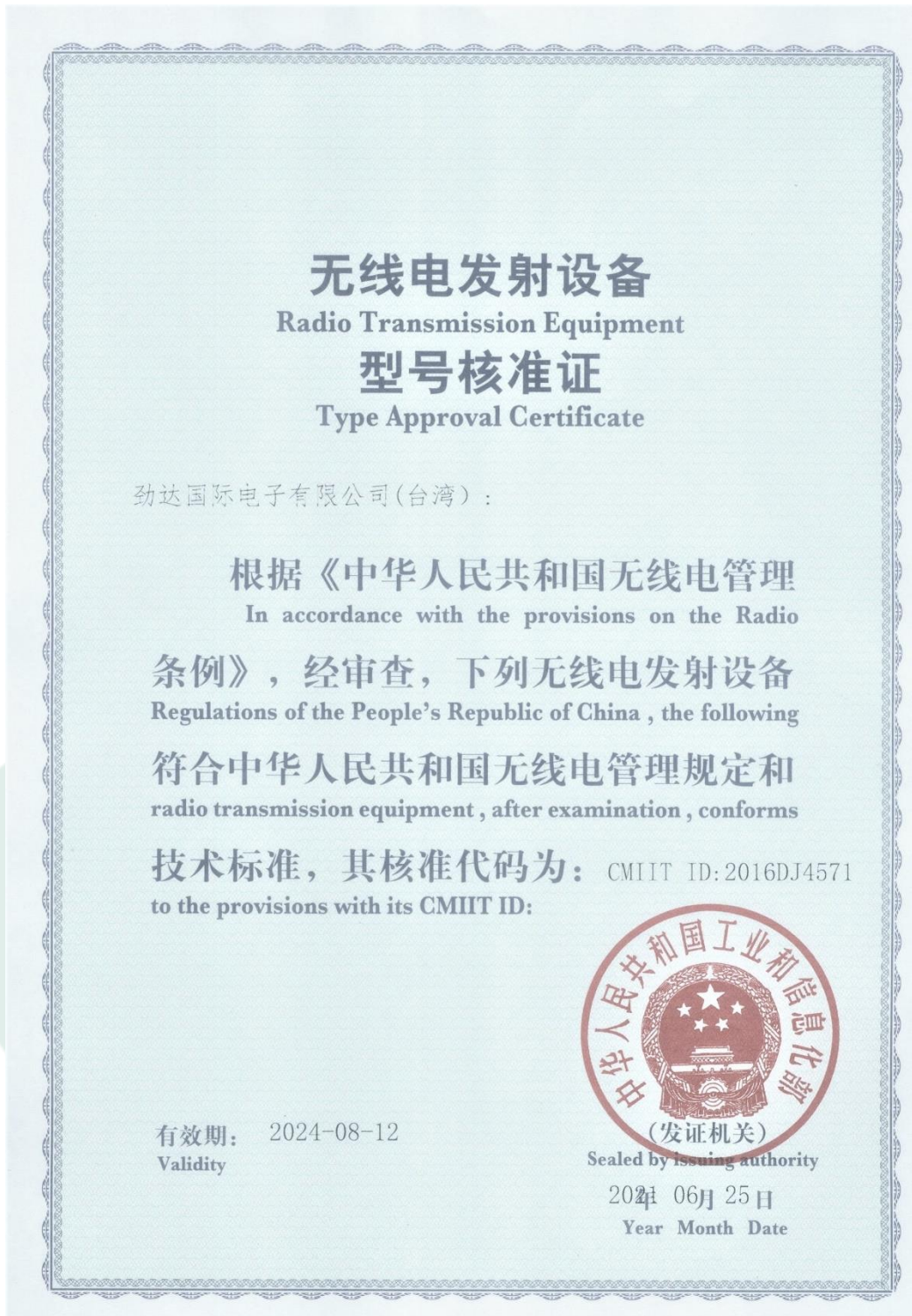

## 9.8. KC Certificate (South Korea)

**BLE 1 Mbps & 2 Mbps**

BSSD-F9CB-417D-C63A

<b>방송통신기자재등의 적합인증서</b> <i>Certificate of Broadcasting and Communication Equipments</i>	
상호 또는 설명 <i>Trade Name or Applicant</i>	Raytac Corporation
기자재명칭(명칭) <i>Equipment Name</i>	특정소출력 무선기기(무선데이터통신시스템용 무선기기)
기본모델명 <i>Basic Model Number</i>	MDBT42Q
파생모델명 <i>Series Model Number</i>	MDBT42Q-P, MDBT42Q-U
인증번호 <i>Certification No.</i>	MSIP-CRM-ryt-MDBT42Q
제조사/제조국가 <i>Manufacturer/ Country of Origin</i>	Raytac Corporation / 대만
인증연월일 <i>Date of Certification</i>	2016-10-06
기타 <i>Others</i>	
<p>위 기자재는 「전파법」 제58조의2 제2항에 따라 인증되었음을 증명합니다.</p> <p>It is verified that foregoing equipment has been certificated under the Clause 2, Article 58-2 of Radio Waves Act.</p> <p style="text-align: right;">2019년(Year) 05월(Month) 14일(Day)</p> <p style="text-align: center;">국립전파연구원장 </p> <p style="text-align: center;"><i>Director General of National Radio Research Agency</i></p> <p style="text-align: center; color: red; font-size: small;">※ 인증 받은 방송통신기자재는 반드시 "적합성평가표시" 를 부착하여 유통하여야 합니다. 위반시 과태료 처분 및 인증이 취소될 수 있습니다.</p>	



## 9.9. RoHS & REACH Report

Please visit "[Support](#)" page of our website to download.

## 9.10. End-Product Label

It is suggested using following content adding to package or user manual or label to obey the regulation. Any rules of end-product label shall refer to each certification for final reference.

### 9.10.1. FCC (USA)

The FCC statement should be included in the user manual when there is no enough space on label. Otherwise, it should be included on the label.

"This device complies with part 15 of the FCC rules. Operation is subject to the following two conditions. (1) This device may not cause harmful interference. (2) This device must accept any interference received, including interference that may cause undesired operation."

The final end product must be labeled in a visible area with the following: "Contain FCC ID: SH6MDBT42Q".

### 9.10.2. TELEC (Japan)

When manufacturer is placing the product on the Japanese market, the product must be affixed with the following Specified Radio Equipment marking:

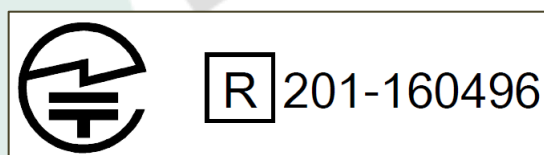



### 9.10.3. NCC (Taiwan)

請依下列標籤式樣自製標籤，標貼或印鑄於器材本體明顯處，始得販賣或公開陳列。

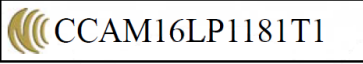
Series	標籤樣式
MDBT42Q Series	
MDBT42Q-P Series	

以 MDBT42Q 為例，平台廠商必須於平台上標示字樣「本產品內含射頻模組：ID 編號 CCAM16LP1180T2」。

「平台」定義如下：若器材組裝本案模組，消費者仍能正常使用該器材主要功能，該器材得視為平台。若器材不組裝本案模組，消費者不能正常使用該器材主要功能，該器材不能視為平台。該類不同廠牌型號器材組裝本案審驗模組後，須分別申請型式認證。

### 9.10.4. IC (Canada)

The IC statement should be included in the user manual when there is no enough space on label. Otherwise, it should be included on the label.

“This device complies with Industry Canada license-exempt RSS Standard(s). Operation is subject to the following two conditions. (1) This device may not cause harmful interference. (2) This device must accept any interference received, including interference that may cause undesired operation.

Le présent appareil est conforme aux CNR d'Industrie Canada applicables aux appareils radio exempts de licence. L'exploitation est autorisée aux deux conditions suivantes: (1) l'appareil ne doit pas produire de brouillage, et (2) l'utilisateur de l'appareil doit accepter tout brouillage radioélectrique subi, même si le brouillage est susceptible d'en compromettre le fonctionnement.”

The final end product must be labeled in a visible area with the following: “Contain IC ID: 8017A-MDBT42Q”.

## 10. Notes and Cautions

Module is not designed to last for a lifetime. Like general products, it is expected to be worn out after continuous usage through the years. To assure that product will perform better and last longer, please make sure you:

- Follow the guidelines of this document while designing circuit/end-product. Any discrepancy of core Bluetooth technology and technical specification of IC should refer to definition of Bluetooth Organization and Nordic Semiconductor as final reference.
- Do not supply voltage that is not within range of specification.
- Eliminate static electricity at any cost when working with the module as it may cause damage. It is highly recommended adding anti-ESD components to circuit design to prevent damage from real-life ESD events. Anti-ESD methods can be also applied in mechanical design.
- Do not expose modules under direct sunlight for long duration. Modules should be kept away from humid and salty air conditions, and any corrosive gasses or substances. Store it within  $-40^{\circ}\text{C}$  to  $+125^{\circ}\text{C}$  before and after installation.
- Avoid any physical shock, intense stress to the module or its surface.
- Do not wash the module. No-Clean Paste is used in production. Washing it will oxidize the metal shield and have chemistry reaction with No-Clean Paste. Functions of the module are not guaranteed if it has been washed.

The module is not suitable for life support device or system and not allowed to be used in destructive device or systems in any direct or indirect ways. The customer agrees to indemnify Raytac for any losses when applying modules in applications such as the ones described above.

# 11. Basic Facts for nRF52 Chip

Below chart shows basic spec for Nordic nRF52 family, which is helpful to understand the differences between each SoC. Any discrepancy shall refer to Nordic’s technical document as final reference.

See [Full List of Raytac’s BLE Modules](#) for complete model no. of each item.

Nordic Solution	nRF52840	nRF52833	nRF52820	nRF52832	nRF52810	nRF52811	nRF52805
RAYTAC Model No. (MDBTXX)	50Q series	50Q series 50 series	50 series	42Q series 42 series 42V series	42Q series	42Q Series	42T series 42TV series
Bluetooth Direction Finding		V	V			V	
Bluetooth 5 Long Range (125kbps)	V	V	V			V	
Bluetooth 5 High Speed	V	V	V	V	V	V	V
Bluetooth 5 Ad. Extention (x8)	V	V	V	V	V	V	V
Flash (kBytes)	1024	512	256	512	192	192	192
RAM (kBytes)	256	128	32	64	24	24	24
ANT Plus	V	V	V	V	V	V	
IEEE 802.15.4	V	V	V			V	
ARM® TrustZone® Cryptocell	V						
USB	V	V	V				
QSPI	V						
NFC	V	V		V			
I2S	V	V		V			
SPI, TWI, UART, PWM	V	V	V	V	V	V	without PWM
PDM	V	V		V	V	V	
ADC, Comparators	V	V	without ADC	V	V	V	without comparators
Supply Range (V)	1.7 to 5.5	1.7 to 5.5	1.7 to 5.5	1.7 to 3.6	1.7 to 3.6	1.7 to 3.6	1.7 to 3.6

## 12. Useful Links

- **Nordic Infocenter:** <https://infocenter.nordicsemi.com/index.jsp>  
All the necessary technical files and software development kits of Nordic's chip are on this website.
- **Nordic DevZone:** <https://devzone.nordicsemi.com/questions/>  
A highly recommended website for firmware developer. Interact with other developers and Nordic's employees will help with your questions. The site also includes tutorials in detail to help you get started.
- **Official Page of nRF52811:**  
<https://www.nordicsemi.com/Products/Low-power-short-range-wireless/nRF52811>  
A brief introduction to nRF52811 and download links for Nordic's developing software and SoftDevices.

# Full List of Raytac's BLE Modules

## ● MDBT40 Series

Series	Nordic Solution	Raytac No.	IC Ver.	Antenna	RAM	Flash Memory
MDBT40	nRF51822	MDBT40-256V3	3	Chip Antenna	16 kb	256 K
		MDBT40-256RV3			32 kb	256 K
MDBT40-P	nRF51822	MDBT40-P256V3	3	PCB Antenna	16 kb	256 K
		MDBT40-P256RV3			32 kb	256 K

## ● MDBT42Q Series (QFN Package IC)

Series	Nordic Solution	Raytac No.	IC Ver.	Antenna	RAM	Flash Memory
MDBT42Q	nRF52832	MDBT42Q-512KV2	2	Chip Antenna	64 kb	512 K
	nRF52810	MDBT42Q-192KV2	2		24 kb	192 K
	nRF52811	MDBT42Q-192KL	1			
MDBT42Q-P	nRF52832	MDBT42Q-P512KV2	2	PCB Antenna	64 kb	512 K
	nRF52810	MDBT42Q-P192KV2	2		24 kb	192 K
	nRF52811	MDBT42Q-P192KL	1			
MDBT42Q-U	nRF52832	MDBT42Q-U512KV2	2	u.FL Connector	64 kb	512 K

## ● MDBT42 Series (WLCSP Package IC)

Series	Nordic Solution	Raytac No.	IC Ver.	Antenna	RAM	Flash Memory
MDBT42	nRF52832	MDBT42-512KV2	2	Chip Antenna	64 kb	512 K
MDBT42-P		MDBT42-P512KV2		PCB Antenna		

## ● MDBT42V Series (WLCSP Package IC)

Series	Nordic Solution	Raytac No.	IC Ver.	Antenna	RAM	Flash Memory
MDBT42V	nRF52832	MDBT42V-512KV2	2	Chip Antenna	64 kb	512 K
MDBT42V-P		MDBT42V-P512KV2		PCB Antenna		

## ● MDBT42T Series (WLCSP Package IC)

Series	Nordic Solution	Raytac No.	IC Ver.	Antenna	RAM	Flash Memory
MDBT42T	nRF52805	MDBT42T-192K	1	Chip Antenna	24 kb	192 K
MDBT42T-P		MDBT42T-P192K		PCB Antenna		

## ● MDBT42TV Series (WLCSP Package IC)

Series	Nordic Solution	Raytac No.	IC Ver.	Antenna	RAM	Flash Memory
MDBT42TV	nRF52805	MDBT42TV-192K	1	Chip Antenna	24 kb	192 K
MDBT42TV-P		MDBT42TV-P192K		PCB Antenna		

## ● MDBT50Q Series (aQFN Package IC)

Series	Nordic Solution	Raytac No.	IC Ver.	Antenna	RAM	Flash Memory
MDBT50Q	nRF52840	MDBT50Q-1MV2	2	Chip Antenna	256 kb	1 MB
	nRF52833	MDBT50Q-512K	1		128 kb	512 kb
MDBT50Q-P	nRF52840	MDBT50Q-P1MV2	2	PCB Antenna	256 kb	1 MB
	nRF52833	MDBT50Q-P512K	1		128 kb	512 kb
MDBT50Q-U	nRF52840	MDBT50Q-U1MV2	2	u.FL Connector	256 kb	1 MB
	nRF52833	MDBT50Q-U512K	1		128 kb	512 kb
Dongle	nRF52840	MDBT50Q-RX	1, 2	PCB Antenna	256 kb	1 MB

## ● MDBT50 Series (QFN Package IC)

Series	Nordic Solution	Raytac No.	IC Ver.	Antenna	RAM	Flash Memory
MDBT50	nRF52820	MDBT50-256R	1	Chip Antenna	32 kb	256 kb
	nRF52833	MDBT50-512K	1		128 kb	512 kb
MDBT50-P	nRF52820	MDBT50-P256R	1	PCB Antenna	32 kb	256 kb
	nRF52833	MDBT50-P512K	1		128 kb	512 kb

## ● MDBT53 Series (WLCSP Package IC)

Series	Nordic Solution	Raytac No.	IC Ver.	Antenna	RAM	Flash Memory
MDBT53	nRF5340	MDBT53-1M	1	Chip Antenna	512 kb	1 MB
MDBT53-P	nRF5340	MDBT53-P1M	1	PCB Antenna	512 kb	1 MB
MDBT53-U	nRF5340	MDBT53-U1M	1	u.FL Connector	512 kb	1 MB

## ● MDBT53V Series (WLCSP Package IC)

Series	Nordic Solution	Raytac No.	IC Ver.	Antenna	RAM	Flash Memory
MDBT53V	nRF5340	MDBT53V-1M	1	Chip Antenna	512 kb	1 MB
MDBT53V-P	nRF5340	MDBT53V-P1M	1	PCB Antenna	512 kb	1 MB



# Release Note

- 2019/06/24 Version A: 1<sup>st</sup> release
- 2020/06/30 Version B
  - (1) Moved section 3 of Chapter 1 under section 1 of Chapter 9: Declaration ID
  - (2) Added tolerance information and updated layout of solder pad in Chapter 2: Product Dimension.
  - (3) Removed Tape & Reel information in Chapter 4: Shipment Packaging Information.
  - (4) Updated CE reports to EN300.328 V2.2.2 & EN62368-1 in Chapter 9: Certification.
  - (5) Added nRF52820 in Chapter 11: Basic Facts of nRF52 Family.
  - (6) Updated Full List of Raytac's BLE modules.
- 2020/12/31 Version C
  - (1) Updated information of T&R in Chapter 4: Shipment Packaging Information.
  - (2) Added BT 5.2 SIG approval in Chapter 9: Certification.
  - (3) Updated table in Chapter 11: Basic Facts for nRF52 Family
  - (4) Updated Full List of Raytac's BLE Modules.
- 2021/07/07 Version D
  - (1) Updated graphs in section 2 of Chapter 2: Product Dimension.
  - (2) Updated information of T&R in Chapter 4: Shipment Packaging Information.
  - (3) Refined description of test code in Chapter 8: Reference Circuit
  - (4) Updated SRRC Certificate in Chapter 9: Certification.
- 2022/07/01 Version E
  - (1) Updated Chapter 4: 4.2.1 Tray Packaging with 4.2.2 Tape & Reel Packaging info.
  - (2) Updated Chapter 2: 2.3 RF Layout Suggestion (aka Keep-Out Area).
  - (3) Updated List of Raytac's Model no.
  - (4) Updated Chapter 5: Specification corresponding to Nordic's new nRF52811 Product Specification V1.1.