

Approval Sheet

(產品承認書)

產品名稱 (Product)	<u>BLE AT Command Module</u> <u>in Peripheral / Slave role</u>
解決方案 (Solution)	<u>Nordic nRF52810 QFN Package</u>
產品型號 (Model No.)	<u>MDBT42Q – AT (Chip Antenna)</u> <u>MDBT42Q – PAT (PCB Antenna)</u>
韌體版本 (FW Rev.)	<u>1.4</u>

Advantage of MDBT42Q & MDBT42Q-P series:

- 1. Long working distance under 1 Mbps:
MDBT42Q: over 80 meters in open space.
MDBT42Q-P: up to 60 meters in open space.*
- 2. Declaration ID includes all Nordic applied profiles.*
- 3. Granted main regional certification such as FCC (USA), CE(EU)
TELEC (Japan), SRRC (China), IC (Canada), NCC (Taiwan), and KC (South Korea)*

Index

1. Overall Introduction	4
2. AT Command	4
2.1. List of supported commands.....	4
2.2. AT Command Sets.....	5
2.2.1. “Write” Commands.....	5
2.2.2. “Read” Commands	8
2.2.3. Response (Default).....	9
2.3. Default Info	11
2.4. Pin Assignment.....	12
3. How to Control via External MCU	14
3.1. How to Send AT Commands.....	14
3.2. How to Transmit Data	15
3.3. How to Return to Setting of Default Flash.....	15
4. Test Report.....	17
4.1. Current Test	17
4.2. Throughput Test.....	18
5. Product Dimension	20
5.1. PCB Dimensions & Pin Indication.....	20
5.2. Recommended Layout of Solder Pad	22
5.3. RF Layout Suggestion (aka Keep-Out Area)	26
5.4. Footprint & Design Guide	28
6. Main Chip Solution.....	29
7. Shipment Packaging Information	30
7.1. Marking on Metal Shield	31
7.2. Packaging Info.....	32
7.3. Order Code.....	34
8. Specification	35
8.1. Absolute Maximum Ratings	35
8.2. Operation Conditions	35
8.3. Electrical Specifications	36

9. Antenna	41
9.1. MDBT42Q Series	41
9.2. MDBT42Q-P Series	42
10. Reference Circuit	43
11. Certification	44
11.1. Declaration ID.....	44
11.2. FCC Certificate (USA)	45
11.3. TELEC Certificate (Japan).....	47
11.4. NCC Certificate (Taiwan)	49
11.5. CE Test Report (EU)	51
11.6. IC Certificate (Canada).....	53
11.7. SRRC Certificate (China).....	55
11.8. KC Certificate (South Korea)	56
11.9. RoHS & REACH Report	57
11.10. End-Product Label	57
12. Notes and Cautions	59
13. Basic Facts for nRF52 Chip	60
14. Useful Links	61
History of Firmware Revision	62
Full List of Raytac’s BLE Modules	64
Release Note	68

1. Overall Introduction

Raytac's MDBT42Q-AT & MDBT42Q-PAT is a BT 5.2 stack (Bluetooth low energy or BLE) module designed based on **Nordic nRF52810 SoC solution**, which incorporates: **UART** interface in only peripheral/slave role for data bridge in compact size **(L) 16 x (W) 10 x (H) 2.2 mm**.

2. AT Command

2.1. List of supported commands

- Setting of device name
- Choose data rate of 1 Mbps or 2 Mbps on-air
- Set TX output power in 5 levels.
- Set advertising time
- Set connection interval under Mode 2
- Enable/disable advertising
- Set LED pattern indicating advertising or connecting status
- 7 sets of UART baud rates
- Enable/disable UART flow control
- Enable/disable interface of UART hardware
- Support 8 programmable output GPIO
- Power-down mode for power saving and GPIO wake-up
- Support DC-to-DC and LDO power mode
- Use internal or external 32.768KHz oscillator
- Recover-to-default setting with hardware and software method
- System reset of hardware and software
- Set serial number and retrieve
- Set or retrieve MAC Address
- Retrieve ADC value for battery detection, delivering the information through battery service.
- Support maximum MTU 247bytes / data payload up to maximum 244 bytes

2.2. AT Command Sets

2.2.1. "Write" Commands

No.	Command	Description
(1)	AT+NAME	Set device name,Max. length of 20 characters e.g. AT+NAME123 (device name 123, 3 characters)
(2)	AT+RESET	Set to reset system
(3)	AT+ADVSTART	Set to start advertising
(4)	AT+ADVSTOP	Set to stop advertising
(5)	AT+SLEEP	Set to get into deep sleep mode
(6)	AT+BAUDRATE9600	Set UART baud rate at 9600 bps,n,8,1
(7)	AT+BAUDRATE19200	Set UART baud rate at 19200 bps,n,8,1
(8)	AT+BAUDRATE38400	Set UART baud rate at 38400 bps,n,8,1
(9)	AT+BAUDRATE57600	Set UART baud rate at 57600 bps,n,8,1
(10)	AT+BAUDRATE115200	Set UART baud rate at 115200 bps,n,8,1
(11)	AT+BAUDRATE230400	Set UART baud rate at 230400 bps,n,8,1 (recommended enabling flow control)
(12)	AT+BAUDRATE460800	Set UART baud rate at 460800 bps,n,8,1 (recommended enabling flow control)
(13)	AT+FLOWCONTROLDIS	Disable UART flow control
(14)	AT+FLOWCONTROLEN	Enable UART flow control
(15)	AT+TXPOWER4DBM	Set RF TX power at + 4dBm
(16)	AT+TXPOWER0DBM	Set RF TX power at 0dBm
(17)	AT+TXPOWER-4DBM	Set RF TX power at - 4dBm
(18)	AT+TXPOWER-8DBM	Set RF TX power at - 8dBm
(19)	AT+TXPOWER-20DBM	Set RF TX power to - 20dBm
(20)	AT+XTALINTERNAL	Use internal RC 32.768KHZ low frequency oscillator
(21)	AT+XTALEXTERNAL	Use external crystal 32.768KHZ low frequency oscillator
(22)	AT+CONNECTINDICATORLOW	Set logic low output when connecting BT
(23)	AT+CONNECTINDICATORHIGH	Set logic high output when connecting BT
(24)	AT+PHYMODE1MBPS	Set PHY mode at 1Mbps

No.	Command	Description
(25)	AT+PHYMODE2MBPS	Set PHY mode at 2Mbps
(26)	AT+WAKEUPLOW	Set logic low at wake-up when in deep sleep
(27)	AT+WAKEUPHIGH	Set logic high at wake-up when in deep sleep
(28)	AT+ADVTIMEtttt	Set advertising time (Hex) e.g. 0x001E (min. 30secs), 0x0E10 (Max. 3,600secs) 0x0000 (forever)
(29)	AT+DCDCDIS	Disable DC to DC converter
(30)	AT+DCDCEN	Enable DC to DC converter
(31)	AT+CONNECTINTERVALMODE0	Set connection interval mode for iOS/Android APP usage (min. 20ms / Max. 40ms),
(32)	AT+CONNECTINTERVALMODE1	Set connection interval mode for nRF52832 Central usage (min. 8ms / Max. 8ms)
(33)	AT+CONNECTINTERVALMODE2	Set connection interval mode for iOS/Android APP usage (programmable: min. / Max. range is 8ms ~ 1,000ms)
(34)	AT+CONNECTINTERVALTIMEtttttttt	Set connection interval time (Hex), available when activating "AT+CONNECTINTERVALMODE2" e.g. 0x0008 (8ms), 0x03E8 (1,000ms), conditions to be met: "min. connection interval ≤ Max. connection interval"
(35)	AT+ADVPATTERNnnnnnffff	Set LED advertising pattern (Hex), where n = time when LED on, f = time when LED off e.g. 0x0064 (min. 100ms) 0x1388 (Max. 5000ms), 0x00000000 (off) 0xFFFFFFFF (on)
(36)	AT+CONNECTPATTERNnnnnnffff	Set LED connecting pattern (Hex), where n = time when LED on, f = time when LED off e.g. 0x0064 (min. 100ms) 0x1388 (Max. 5000ms) 0x00000000 (off) 0xFFFFFFFF (on)

No.	Command	Description
(37)	AT+SERIALNOnnnnnnnn	Set serial number e.g. AB000001, fixed 8-character length
(38)	AT+RESPONSEDIS	Disable response when sending "write" command
(39)	AT+RESPONSEEN	Enable response when sending "write" command
(40)	AT+DISCONNECT	Terminate the connection
(41)	AT+DEFAULT	Back to default
(42)	AT+SETGPIOnnHIGH	Set GPIO number p0.nn to high, where "nn" is range from 12 ~ 19 (Ascii)
(43)	AT+SETGPIOnnLOW	Set GPIO number p0.nn to low, where "nn" is range from 12 ~ 19 (Ascii)
(44)	AT+SETGPIOnnOFF	Set GPIO number p0.nn to unused, where "nn" is range from 12 ~ 19 (Ascii)
(45)	AT+MACADDRnnnnnnnnnnnn	Set IC MAC address, where n is Hex . Written order is from MSB byte to LSB byte.

2.2.2. “Read” Commands

No.	Command	Description
(1)	AT?NAME	To retrieve device name
(2)	AT?VERSION	To retrieve firmware version
(3)	AT?MACADDR	To retrieve IC MAC address
(4)	AT?BAUDRATE	To retrieve current UART baud rate
(5)	AT?FLOWCONTROL	To retrieve UART status of flow control
(6)	AT?TXPOWER	To retrieve RF TX power
(7)	AT?XTAL	To retrieve status of oscillator
(8)	AT?CONNECTINDICATOR	To retrieve logic of pin for BT-connecting indicator
(9)	AT?PHYMODE	To retrieve status of PHY mode
(10)	AT?WAKEUP	To retrieve logic of wake-up pin
(11)	AT?ADVTIME	To retrieve advertising time (Hex)
(12)	AT?DCDC	To retrieve DC to DC converter status
(13)	AT?CONNECTINTERVALMODE	To retrieve status of connection interval mode
(14)	AT?ADVPATTERN	To retrieve LED advertising pattern (Hex)
(15)	AT?CONNECTPATTERN	To retrieve LED connecting pattern (Hex)
(16)	AT?SERIALNO	To retrieve serial number
(17)	AT?ADCVALUE	To retrieve 10bit ADC value
(18)	AT?RESPONSE	To retrieve status of response
(19)	AT?ALLPARAMETERS	To retrieve value of all parameters
(20)	AT?CONNECTINTERVALTIME	To retrieve value of connection interval time under Mode 2

2.2.3. Response (Default)

No.	Command	Response
(1)	AT?NAME	Raytac AT-UART (default)
(2)	AT?VERSION	e.g. version: 1.0
(3)	AT?MACADDR	e.g. D352BDE1E414
(4)	AT?BAUDRATE	0 baudrate9600 (default) (0 = 9600; 1 = 19200; 2 = 38400; 3 = 57600; 4 = 115200; 5 = 230400; 6 = 460800)
(5)	AT?FLOWCONTROL	0 flowcontrol dis (default) (0 = disabled; 1 = enabled)
(6)	AT?TXPOWER	0 txpower 4dbm (default) (0 = 4dBm; 1 = 0dBm; 2 = -4dBm; 3 = -8dBm, 4 = -20dBm)
(7)	AT?XTAL	0 xtal internal (default) (0 = internal; 1 = external, and XTAL = 32.768KHz oscillator)
(8)	AT?CONNECTINDICATOR	0 connect indicator low (default) (0 = output low; 1 = output high)
(9)	AT?PHYMODE	0 PHY mode 1Mbps (default) (0 = 1Mbps; 1 = 2Mbps)
(10)	AT?WAKEUP	0 wakeup low (default) (0 = low active; 1 = high active)
(11)	AT?ADVTIME	0000 (default: Hex, forever advertising with no timeout, tttt: 0x0000)
(12)	AT?DCDC	0 dcdc dis (default) (0 = disabled; 1 = enabled)
(13)	AT?CONNECTINTERVALMODE	0 connect interval mode 0 (default) (0 = fixed connection interval for iOS/Android APP usage 1 = fixed connection interval, for nRF52832 Central usage 2 = programmable connection interval for iOS/Android APP usage)
(14)	AT?ADVPATTERN	01F401F4 (default: Hex , 0.5sec on / 0.5sec off, nnnn: 0x01F4, ffff: 0x01F4)

No.	Command	Response
(15)	AT?CONNECTPATTERN	00c80708 (default: Hex, 0.2sec on / 1.8sec off, nnnn: 0x00c8, ffff: 0x0708)
(16)	AT?SERIALNO	Display “ no data! ” string (default)
(17)	AT?ADCVALUE	Value varies from input voltage
(18)	AT?RESPONSE	1 response en (default) (0 = disable response; 1 = enable response)
(19)	AT?ALLPARAMETERS	Display value of all parameters, separated by "0x0d0x0a"
(20)	AT?CONNECTINTERVALTIME	006400C8 (default: Hex , 100ms min. connection interval / 200ms Max. connection interval, tttttt: 0x006400C8)



2.3. Default Info

No.	Description	Default
(1)	Device name	Raytac AT-UART
(2)	Base UUID	0x9E, 0xCA, 0xDC, 0x24, 0x0E, 0xE5, 0xA9, 0xE0 0x93, 0xF3, 0xA3, 0xB5, 0x00, 0x00, 0x40, 0x6E
(3)	Service UUID	0x0001 TX characteristic: 0x0003; RX characteristic: 0x0002
(4)	Baud rate	9600bps,n,8,1
(5)	Status of flow control	Disabled
(6)	RF TX power	+4dBm
(7)	32.768Khz oscillator	Using internal RC with 1000ms calibration time
(8)	Logic of BT connecting indicator	Output set as logic low when BT is connecting
(9)	PHY mode	1Mbps
(10)	Logic of wake-up pin	Set logic low to wake up in deep sleep
(11)	Advertising time	Forever advertising with no timeout
(12)	Status of DC-to-DC converter	Disabled
(13)	Connection interval mode	Set at min. 20ms and Max. 40ms for iOS/Android usage
(14)	Advertising LED pattern	0.5sec on / 0.5sec off
(15)	Connecting LED pattern	0.2sec on / 1.8secs off
(16)	Serial number	Display " no data! " string
(17)	ADC value	Value varies from input voltage between 0x0000 ~ 0x03FF (Hex).
(18)	State of response	Enabled
(19)	Programmable output GPIO	P0.12, P0.13, P0.14, P0.15, P0.16, P0.17, P0.18 and P0.19 are unused

2.4. Pin Assignment

Pin No.	Name	Pin Function	Description
(1)	GND	Ground	The pad must be connected to a solid ground plane
(2)	NC	No function	Not connected
(3)	NC	No function	Not connected
(4)	NC	No function	Not connected
(5)	NC	No function	Not connected
(6)	NC	No function	Not connected
(7)	NC	No function	Not connected
(8)	NC	No function	Not connected
(9)	DEC4	Power	1V3 regulator supply decoupling. Input from DC/DC converter. Output from 1V3 LDO .
(10)	DCC	Power	DC/DC converter output pin
(11)	VDD	Power	Power-supply pin
(12)	GND	Ground	The pad must be connected to a solid ground plane
(13)	NC	No function	Not connected when using internal RC (LFXO)
	XL1	Analog input	Connecting to 32.768KHz crystal when using external LFXO
(14)	NC	No function	Not connected when using internal RC (LFXO)
	XL2	Analog input	Connecting to 32.768KHz crystal when using external LFXO
(15)	ADC	Analog input	10bit resolution ADC is always on and update every 200ms
(16)	Indicator	Output / Logic	Output logic is selective about the action of BT connection
(17)	Connecting or Adver. LED	Output	Setting of LED pattern is changeable when it is active-low
(18)	UART RTS	Output	RTS, request to send
(19)	UART TX	Output	UART transmitter
(20)	UART CTS	Input	CTS, clear to send
(21)	UART RX	Input	UART receiver

Pin No.	Name	Pin Function	Description
(22)	Wakeup	Input / Logic	Output logic is selective about the action of wakeup from deep sleep
(23)	UART PD	Input	Active-high with internal pull-high to disable hardware UART interface. The default is disabled.
(24)	GND	Ground	The pad must be connected to a solid ground plane
(25)	Flash Default	Input	Active-low with internal pull-high for $0.48\text{sec} \leq \text{logic low} \leq 1\text{sec}$ and return to logic high, then system will back to default.
(26)	P0.12	Output / NC	Programmable output GPIO, NC when set unused
(27)	P0.13	Output / NC	Programmable output GPIO, NC when set unused
(28)	P0.14	Output / NC	Programmable output GPIO, NC when set unused
(29)	P0.15	Output / NC	Programmable output GPIO, NC when set unused
(30)	P0.16	Output / NC	Programmable output GPIO, NC when set unused
(31)	P0.17	Output / NC	Programmable output GPIO, NC when set unused
(32)	P0.18	Output / NC	Programmable output GPIO, NC when set unused
(33)	P0.19	Output / NC	Programmable output GPIO, NC when set unused
(34)	NC	No function	Not connected
(35)	RESET	Input	Active-low to enable hardware system RESET pin
(36)	SWDCLK	Digital input	Serial Wire debug clock input for debug and programming
(37)	SWDIO	Digital I/O	Serial Wire debug I/O for debug and programming
(38)	NC	No function	Not connected
(39)	GND	Ground	The pad must be connected to a solid ground plane

3. How to Control via External MCU

3.1. How to Send AT Commands

- **When BT is NOT connected, for ALL commands**

1. Output low to [UART PD](#) pin to enable UART interface. Please keep it LOW during the whole time when sending AT commands.
2. Send any AT commands you want. **Please wait for at least 250 ms between sending each command.**

We recommend sending corresponding “Read” command ([section 2.2.2](#)) right after the delay to know whether the writing is successful before moving on to step 3 to save your settings.

Please prolong the delay (over 250 ms) when writing or/and reading is not successful.

3. **Send command “ AT+RESET ” (not HW reset) to save all your settings.**
4. **After sending “AT+RESET” command, do NOT write any command and wait at least 1 second for flash to update. Keep the power on during the whole period.**
5. Output high or NC to [UART PD](#) pin to turn off UART interface.

- **When BT is connected for following commands ONLY**

**Write: AT+DISCONNECT, AT+SLEEP, AT+SETGPIOnnHIGH,
AT+SETGPIOnnLOW, AT+SETGPIOnnOFF**

Read: AT?ADCVALUE

1. Output low to **UART PD** pin to enable UART interface. Please keep it LOW during the whole time when sending AT commands.
2. Output low to **flash default** pin to enable receiving AT commands when BT is connected. Please keep it LOW during the whole time when sending AT commands.
3. Send “AT?ADCVALUE” or “AT+DISCONNECT” or “AT+SLEEP” or “AT+SETGPIOnnHIGH” or “AT+SETGPIOnnLOW” or “AT+SETGPIOnnOFF”.
4. Output high or NC to **UART PD** pin to turn off UART interface.
5. Output high or NC to **flash default** pin to disable the module to receive AT commands when BT is connected.

3.2. How to Transmit Data

**** Only when BT is connected ****

1. Output low to **UART PD** pin to enable UART interface. Please keep it LOW during the whole time when transmitting data.
2. Output high or NC to **UART PD** pin to turn off UART interface.

3.3. How to Return to Setting of Default Flash

**** Only when BT is NOT connected ****

**** Note that default baud rate is “9600bps,n,8,1”. For other default, please check [“2.3 Default Info”](#)***

● Use Hardware Method

1. Read **indicator** pin first to check if BT is *NOT* in connection.
2. Output a low pulse to **flash default** pin, then system will return to default setting.

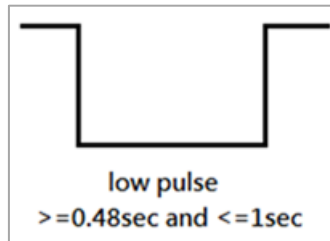

3. After outputting low pulse to flash default pin, do NOT write any command and wait at least 1 second for flash to update. Keep the power on during the whole period.

● Use Software Method

1. Output low to **UART PD** pin to enable UART interface. Please keep it LOW during the whole time when sending AT commands.
2. Send command “AT+DEFAULT”, then system will return to default setting.
3. After sending “AT+DEFAULT” command, do NOT write any command and wait at least 1 second for flash to update. Keep the power on during the whole period.

4. Test Report

All testing is done under **PHY mode at 1M bps.**

4.1. Current Test

DC/DC	Logic of UART PD pin	Advertising Current	Connected Current
Disable	High	0.85 mA	0.3 mA
	Low	1.56 mA	1 mA
Enable	High	0.45 mA	0.16 mA
	Low	0.95 mA	0.68 mA

Sleep Mode	Logic of UART PD pin	Sleep Current
	High	3 uA
	Low	3 uA

4.2. Throughput Test

Here **D.L.** means “**Data Length**” and **D.I.** means “**Data Interval**” in the table.

- MCU → Peripheral (MDBT42Q-AT/MDBT42Q-PAT) → Central → Console

Central Connection Interval	Peripheral Connection Interval	Baud Rate	Flow Control	MCU D.L. (bytes)	MCU D.I. (ms)	Total D.L. (bytes)	Total Trans. Time (sec)	Data Rate (k-bytes/sec)
min = 20ms Max = 75ms	min = 20ms Max = 40ms	9600	X	64	60	262152	273	0.96
				244	250	999432	1,042	
			V	244	250	999432	1,042	
min = 20ms Max = 75ms	min = 20ms Max = 40ms	115200	X	64	8	262152	33	7.9
				244	30	999432	124	8
			V	244	30	999432	124	8
min = 20ms Max = 75ms	min = 20ms Max = 40ms	460800	X	244	25	999432	103	9.7
			V					
min = Max = 8ms	min = Max = 8ms	9600	X	64	60	262152	273	0.96
				244	250	999432	1,042	
			V	244	250	999432	1,042	
min = Max = 8ms	min = Max = 8ms	115200	X	64	8	262152	33	7.9
				244	30	999432	124	8
			V	244	30	999432	124	8
min = Max = 8ms	min = Max = 8ms	460800	X	244	15	999432	62	16.1
			V					

● MCU → Central → Peripheral (MDBT42Q-AT/MDBT42Q-PAT) → Console

Central Connection Interval	Peripheral Connection Interval	Baud Rate	Flow Control	MCU D.L. (bytes)	MCU D.I. (ms)	Total D.L. (bytes)	Total Trans. Time (sec)	Data Rate (k-bytes/sec)
min = 20ms Max = 75ms	min = 20ms Max = 40ms	9600	X	64	60	262152	273	0.96
			V	244	250	999432	1,042	
min = 20ms Max = 75ms	min = 20ms Max = 40ms	115200	X	64	8	262152	33	7.9
			V	244	30	999432	124	8
min = 20ms Max = 75ms	min = 20ms Max = 40ms	460800	X	244	18	999432	74	13.5
			V					
min = Max = 8ms	min = Max = 8ms	9600	X	64	60	262152	273	0.96
			V	244	250	999432	1,042	
min = Max = 8ms	min = Max = 8ms	115200	X	64	8	262152	33	7.9
			V	244	30	999432	124	8
min = Max = 8ms	min = Max = 8ms	460800	X	244	15	999432	61	16.3
			V					

5. Product Dimension

5.1. PCB Dimensions & Pin Indication

• MDBT42Q-AT

PCB Size (in mm)			
	Min.	Norm	MAX.
L		16	
W	- 0.15	10	+ 0.2
H		2.2	

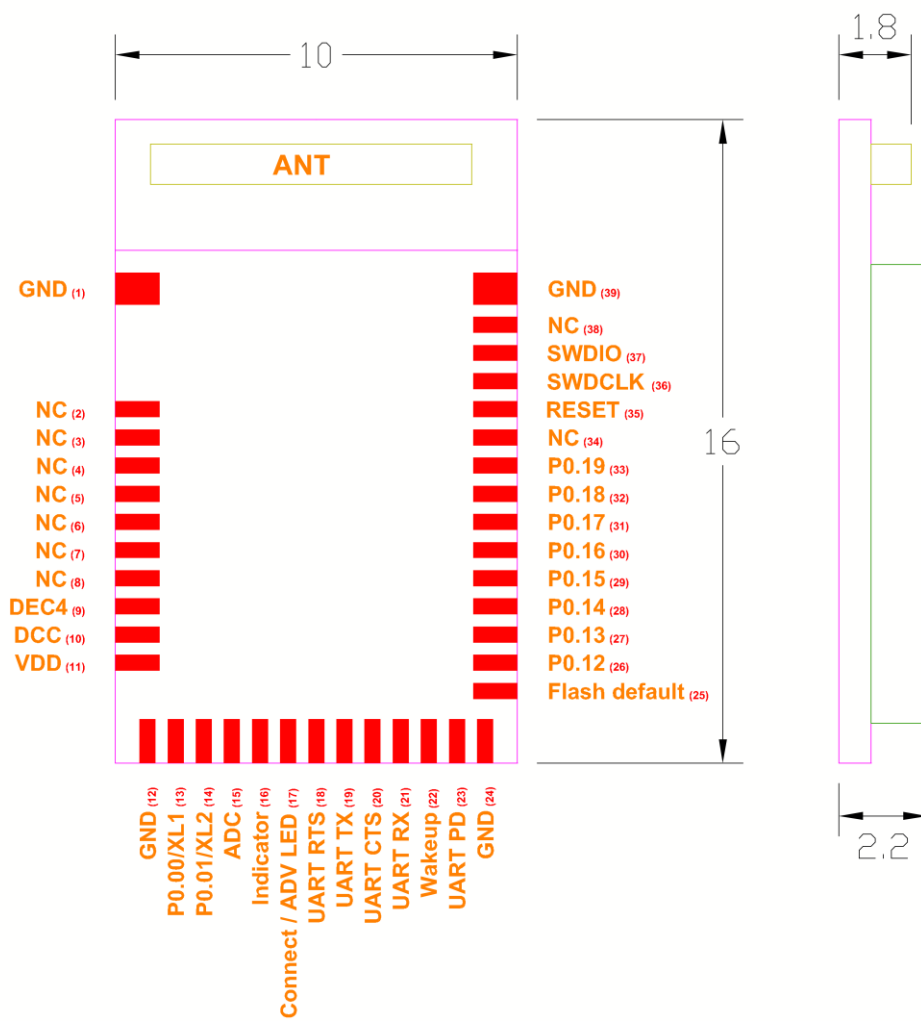

Top (Unit: mm)

• **MDBT42Q-PAT**

PCB Size (in mm)			
	Min.	Norm	MAX.
L		16	
W	- 0.15	10	+ 0.2
H		2.2	

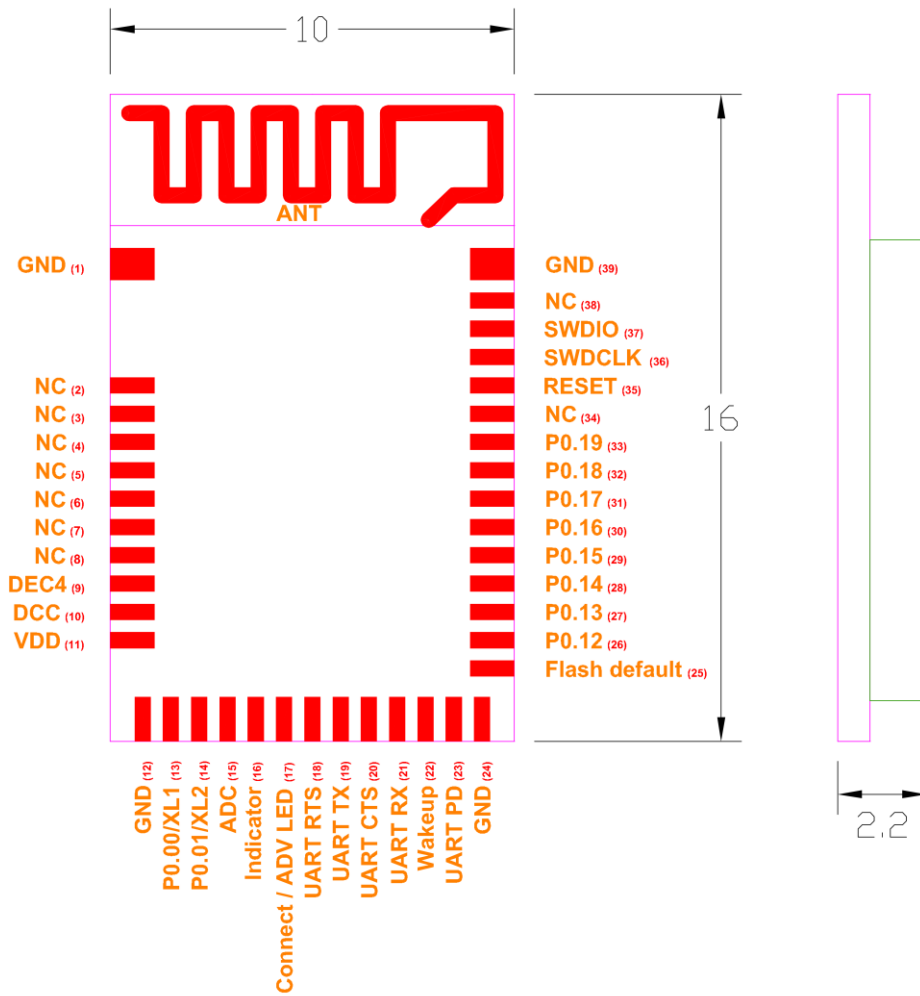

Top (Unit: mm)

5.2. Recommended Layout of Solder Pad

Graphs are all in Top View, Unit in mm.

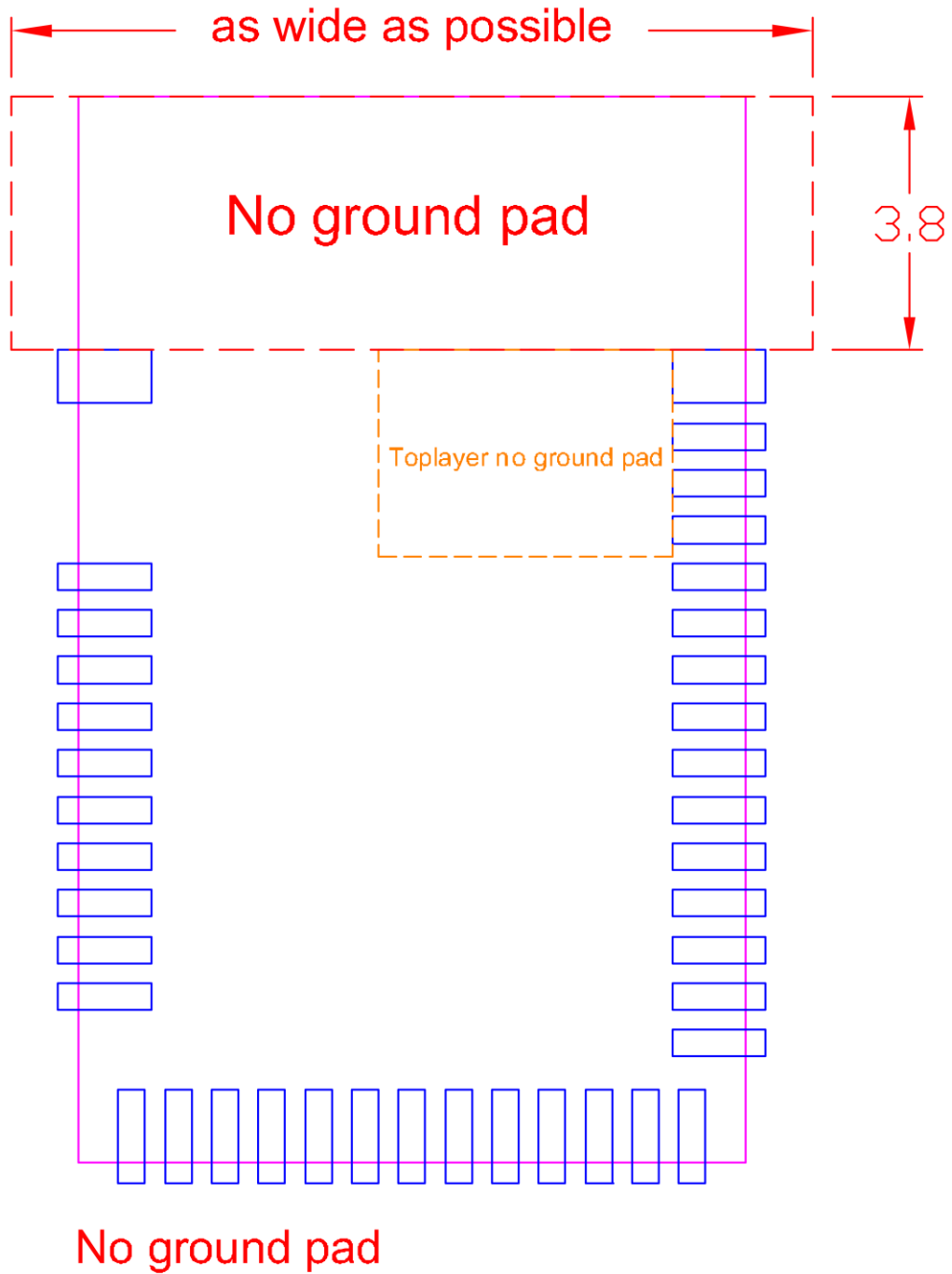

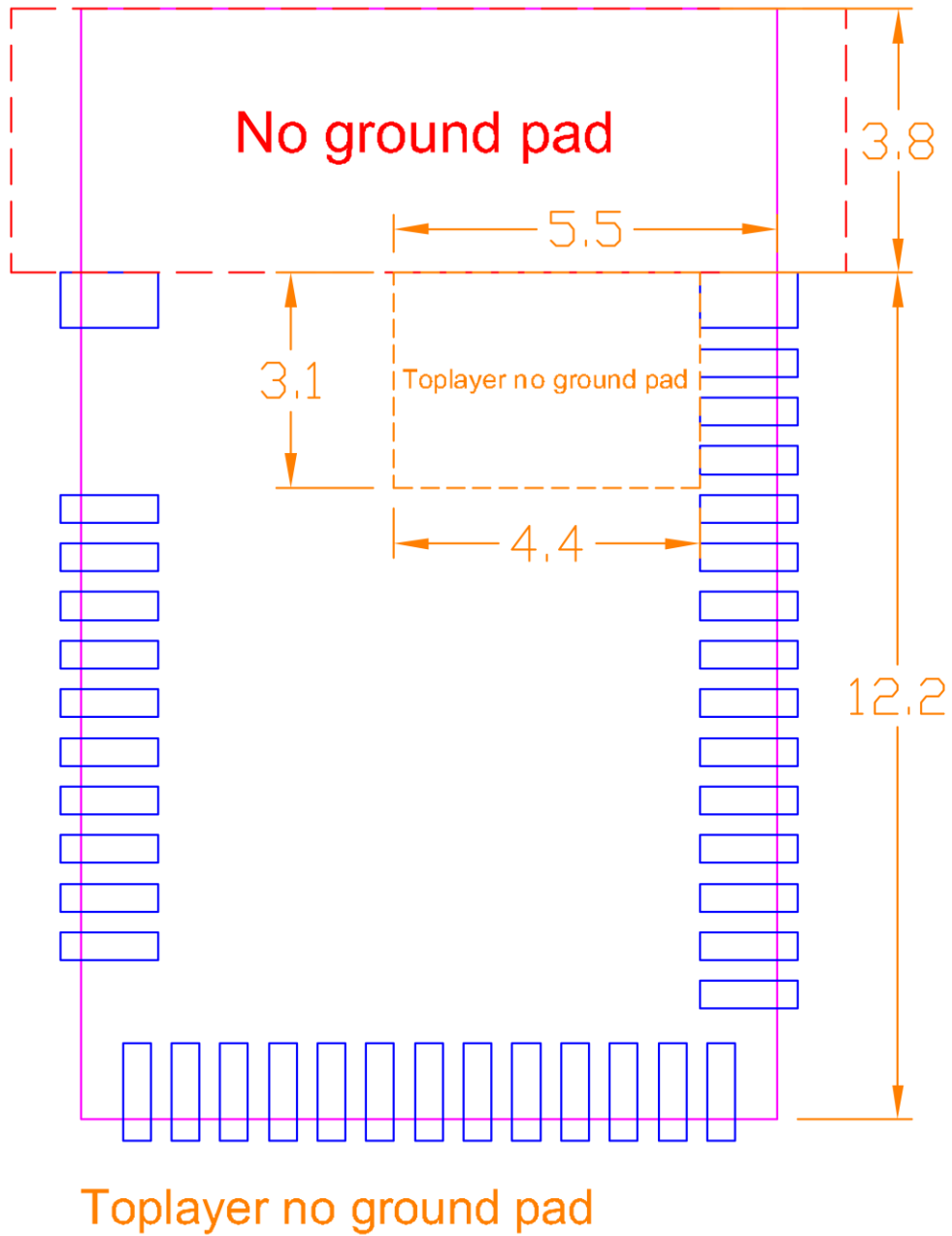

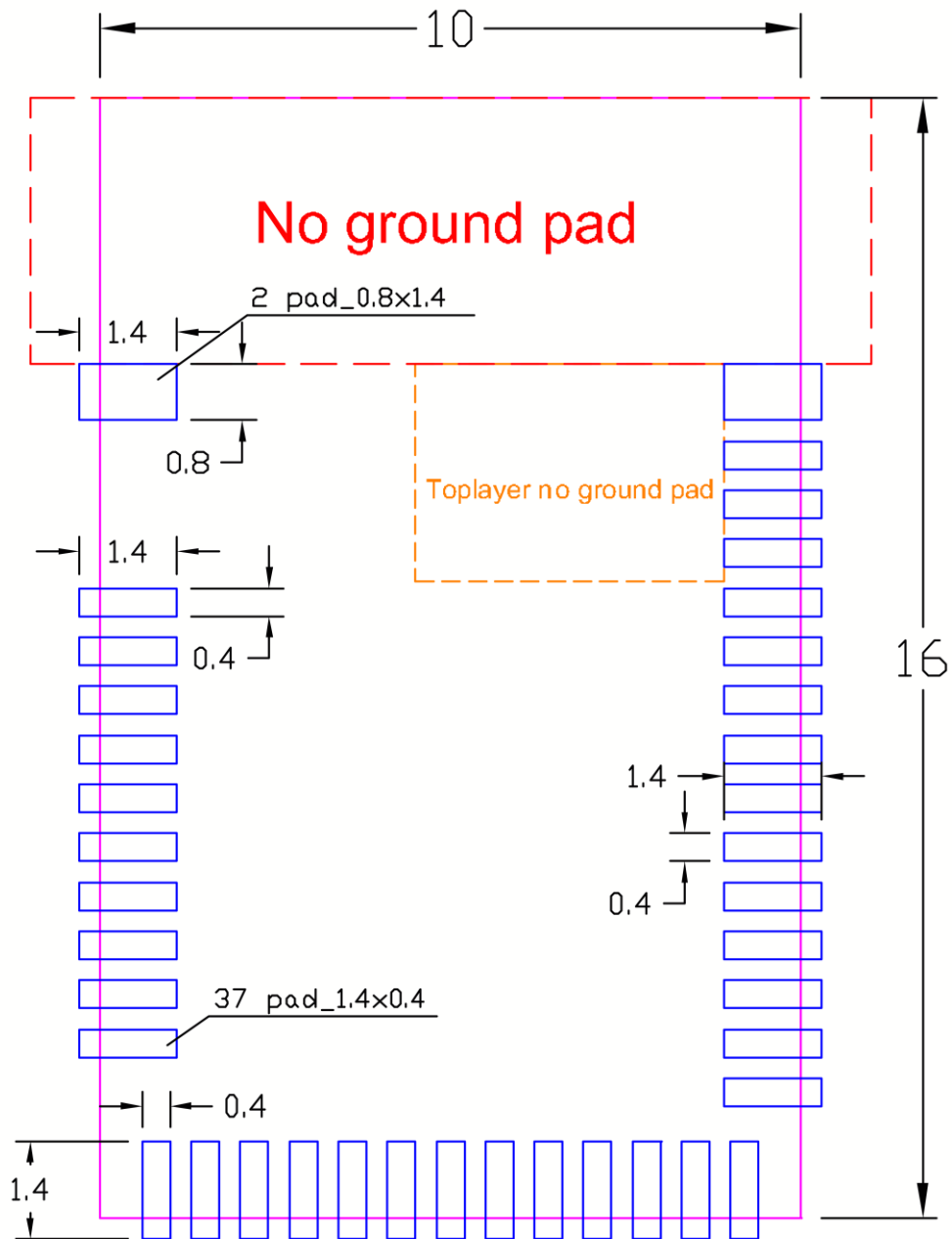

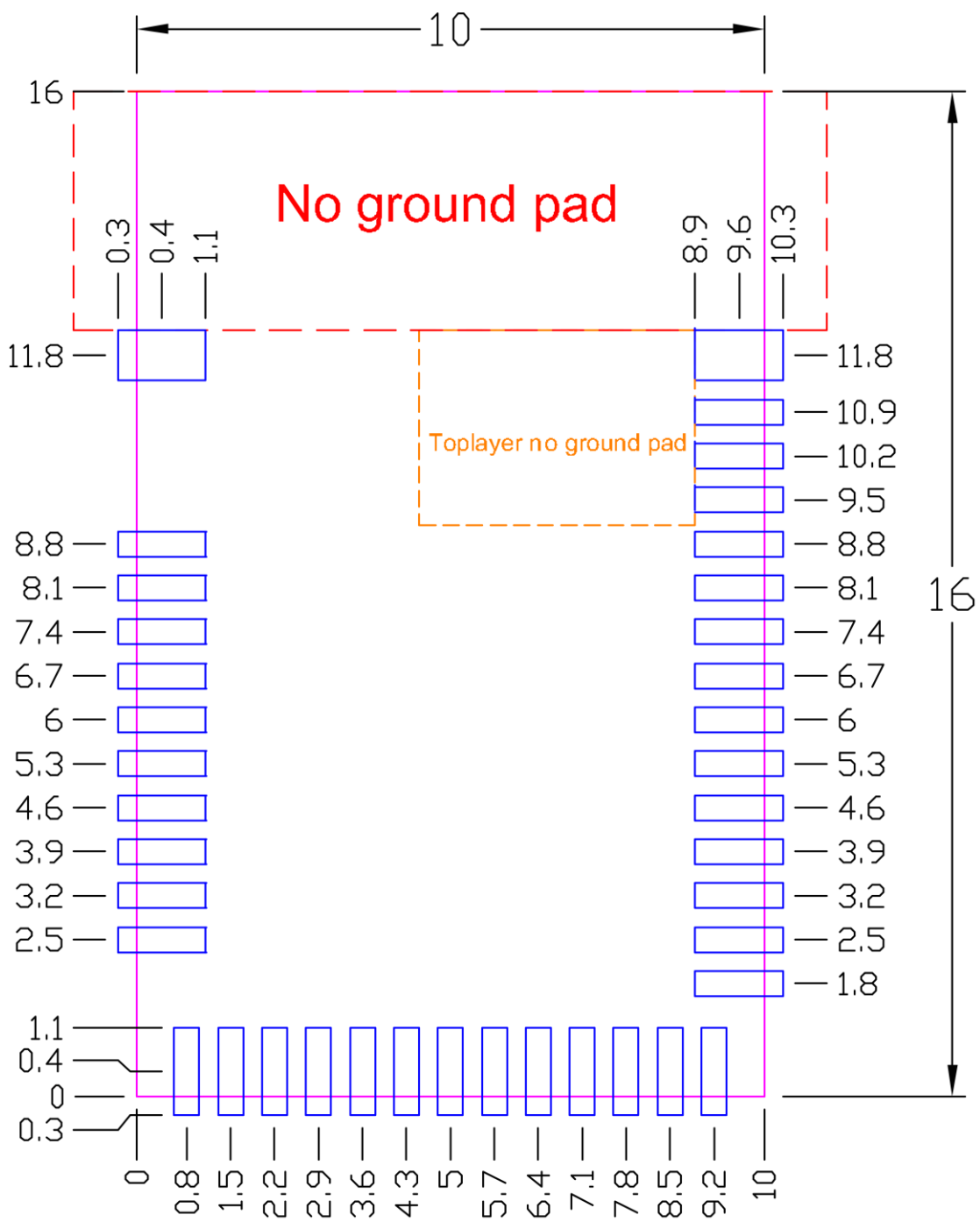

Top View (Unit : mm)
recommended solder pad layout

5.3. RF Layout Suggestion (aka Keep-Out Area)

Make sure to keep the “No Ground Pad” as wider as you can regardless of the size of your PCB.

No Ground Pad should be included in the corresponding position of the antenna in **EACH LAYER**.

Place the module towards the edge of PCB to have better performance than placing it on the center.

Welcome to send us your layout in PDF for review at service@raytac.com or your contact at Raytac with title “Layout reviewing – Raytac model no. – YOUR company’s name”.

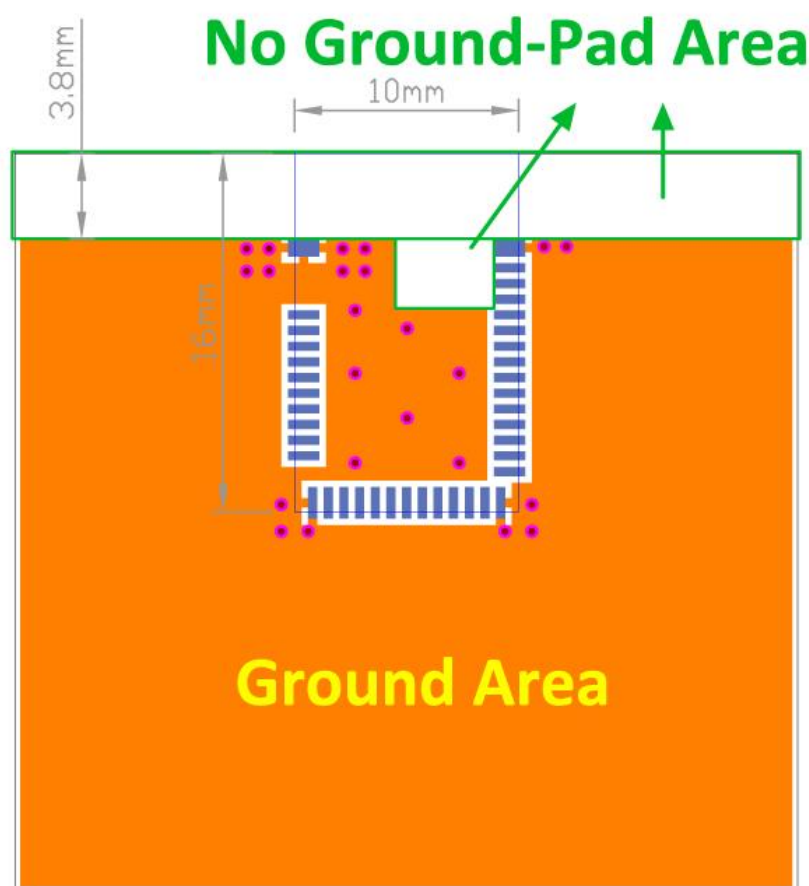

Top layer

Please add via holes in GROUND area as many as possible, especially around the four corners.

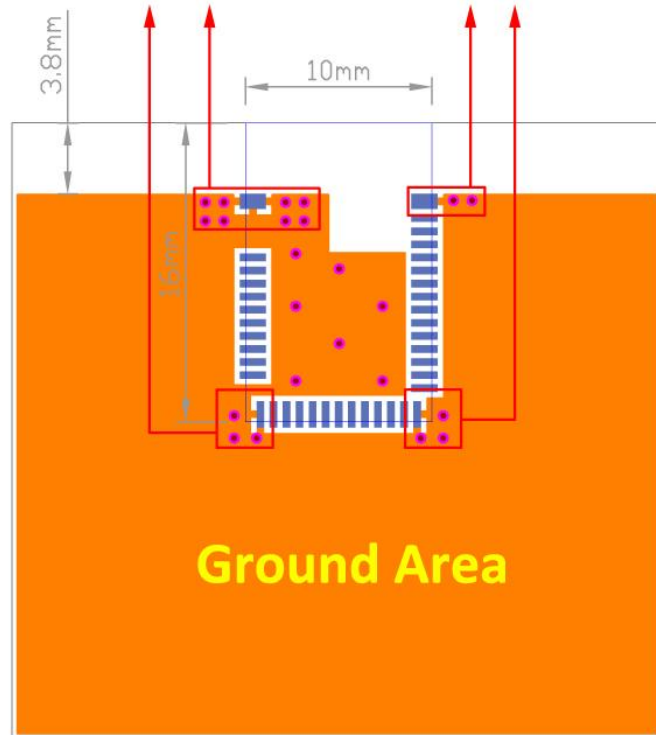

Top layer

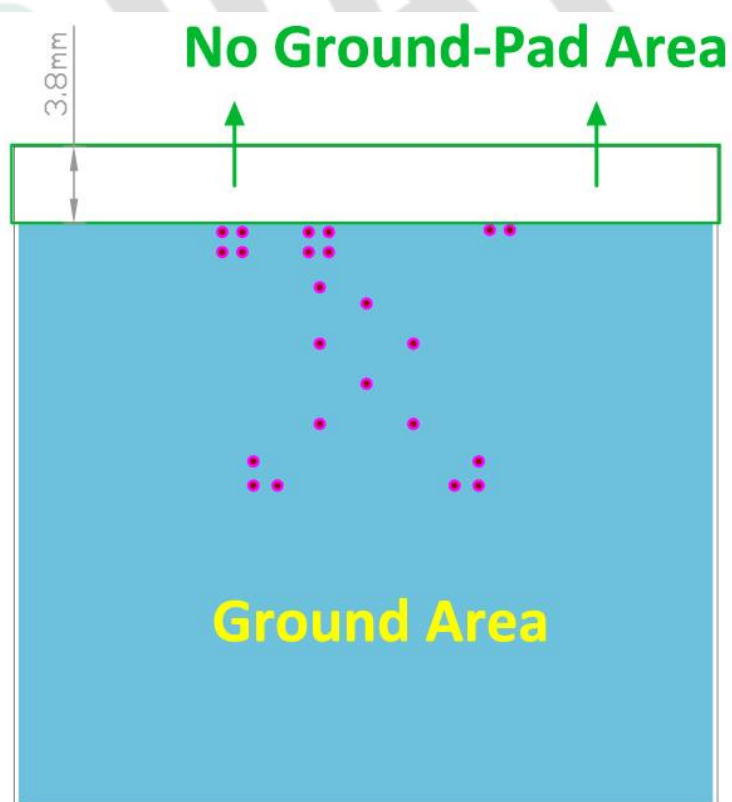

Bottom layer

Examples of “**NOT RECOMMENDED**” layout

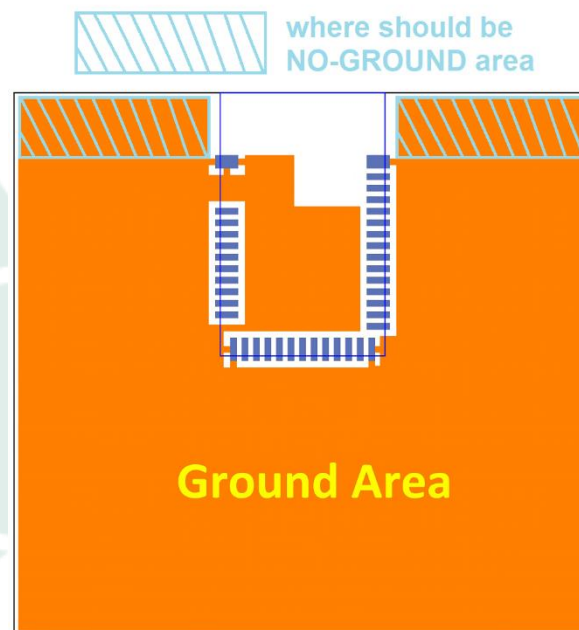
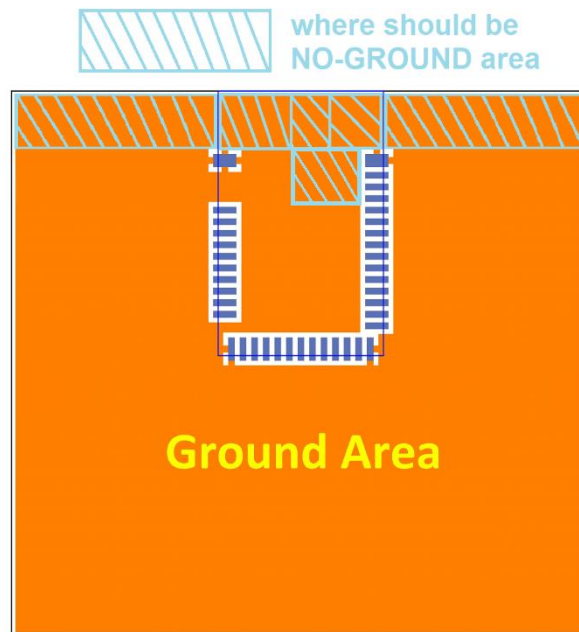

5.4. Footprint & Design Guide

Please visit “[Support](#)” page of our website to download. The package includes footprint, 2D/3D drawing, reflow graph and recommended spec for external 32.768khz.



6. Main Chip Solution

RF IC	Crystal Frequency
Nordic NRF52810	32MHZ

32MHz crystal is already inside the module.



7. Shipment Packaging Information

Model	Antenna	Photo
MDBT42Q-AT	Chip/Ceramic	
MDBT42Q-PAT	PCB/Printed	

- Unit Weight of Module:

MDBT42Q-AT: 0.64g (± 0.02 g) ; MDBT42Q-PAT: 0.62g (± 0.02 g)

- Packaging Type: Anti-Static tray or Tape & Reel.

	Tray	Tape & Reel
MPQ (Min. Package Q'ty)	88 pcs per tray	1,500 pcs per reel
Carton Contents (per carton)	1,760 pcs	1,500 pcs
Carton Dimension (L) x (W) x (H) cm	37 x 21 x 13	37 x 36 x 6
Gross Weight	about 2.8 kgs	about 1.9 kgs

7.1. Marking on Metal Shield

Raytac Corporation
FCC ID: SH6MDBT42Q
IC: 8017A-MDBT42Q
CMIIT ID: 2016DJ4571 
Model No.: MDBT42Q
    201-160496



7.2. Packaging Info

7.2.1. Tray Packaging

Anti-static tray is specifically designed for mass production. It can be used directly on SMT automatic machine.

Before July 1st, 2022

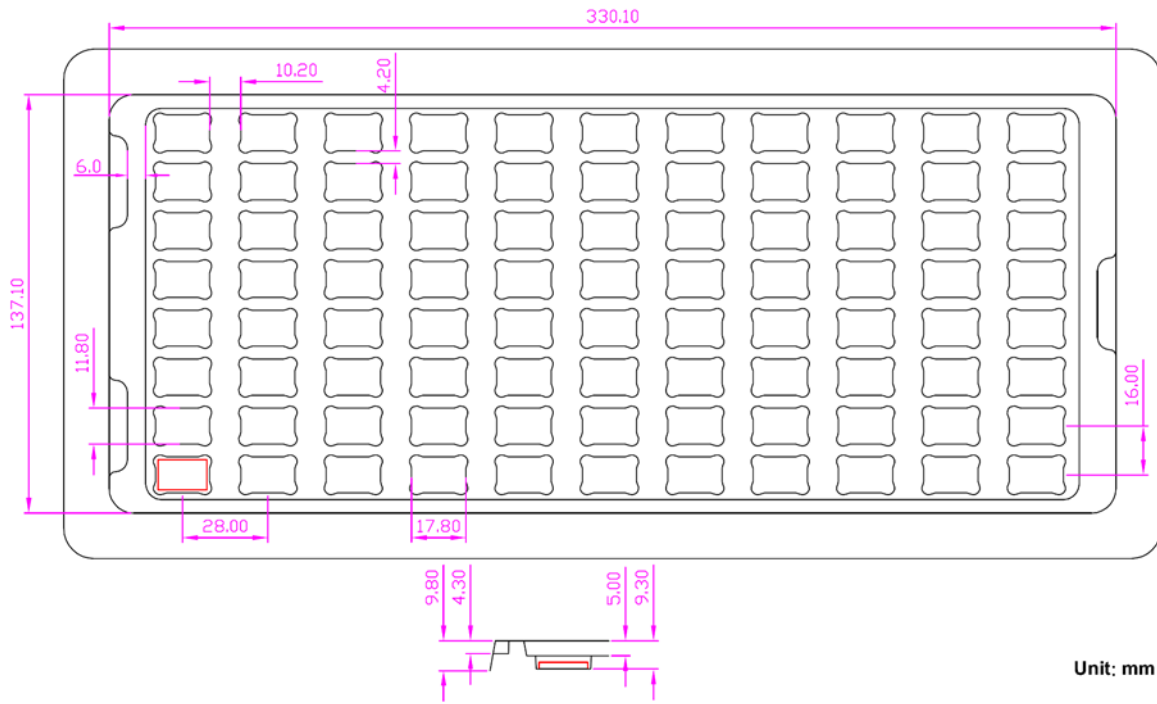

After July 1st, 2022

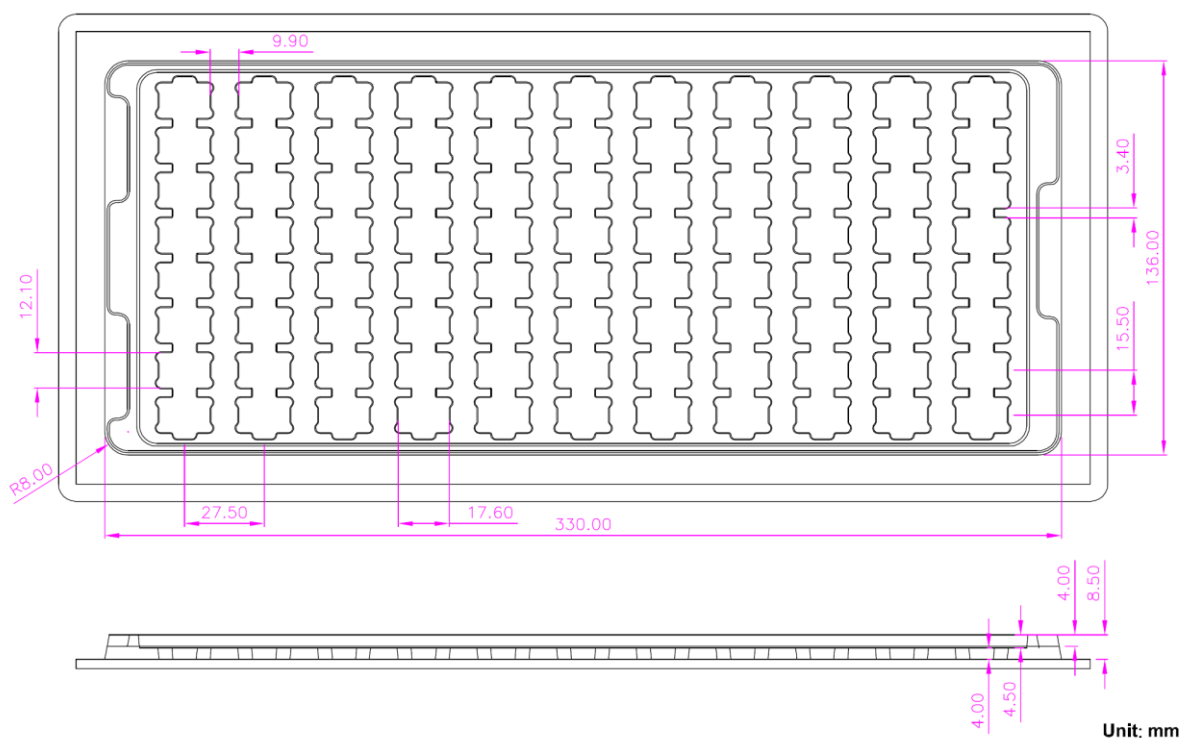

7.2.2. Reel Packaging

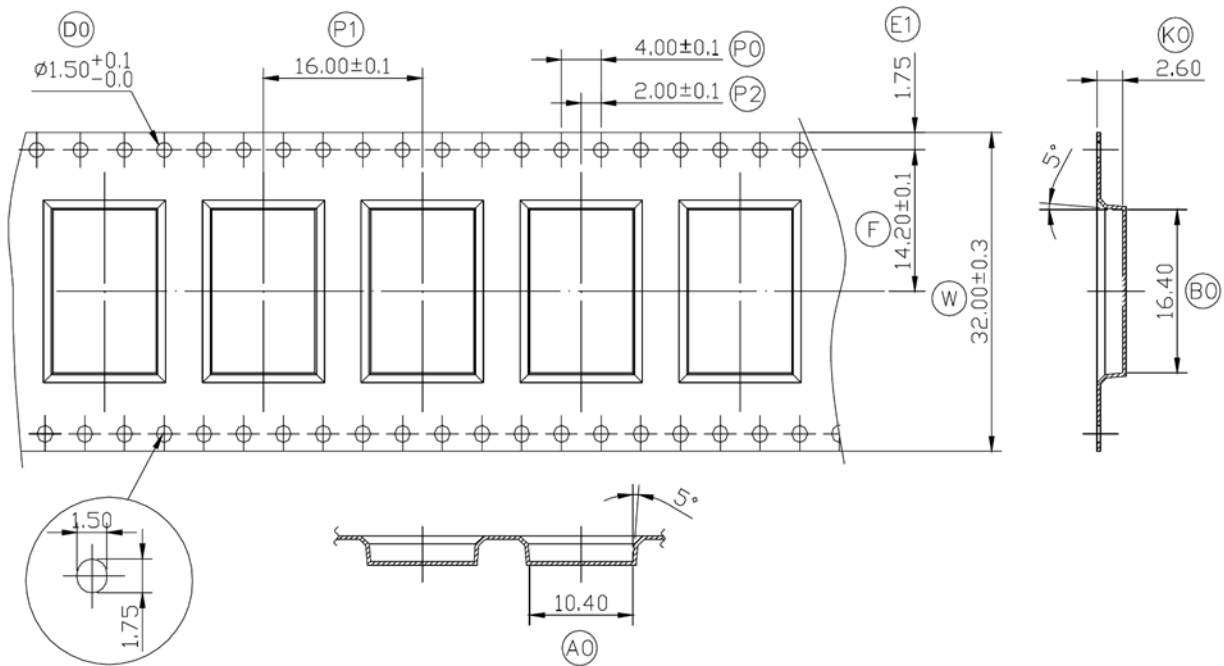

W	32.00	±0.30
P1	16.00	±0.10
E1	1.75	±0.10
F	14.20 ± 0.10	
D0	1.50	+0.1/-0
P0	4.00	±0.10
P2	2.00	±0.10
A0	10.40	±0.10
B0	16.40	±0.10
K0	2.60	±0.10
T	0.30	±0.05

7.3. Order Code

Each model has two options of packaging. Please use following part no. when placing order to us.

Model	Tray	Tape & Reel
MDBT42Q-AT	MD-240A2-S22	MD-240A2-S22R
MDBT42Q-PAT	MD-240A2-S25	MD-240A2-S25R

MPQ of Reel packaging is 1,500 pcs and Tray packaging is 88 pcs.

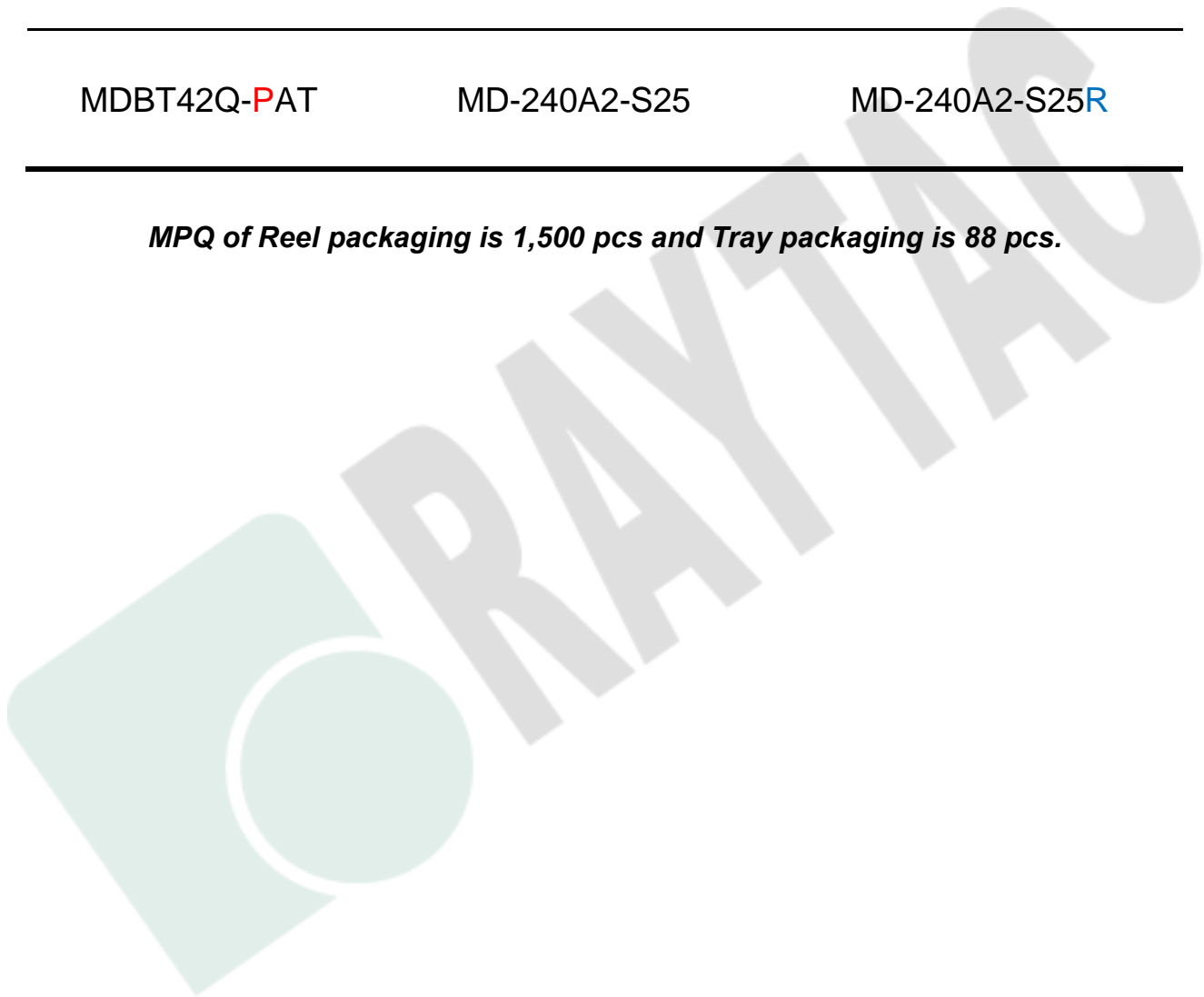

8. Specification

Any technical spec shall refer to Nordic's official documents as final reference. Contents below are from "[nRF52810 Product Specification v1.4](#)", please click to download full spec.

8.1. Absolute Maximum Ratings

	Note	Min.	Max.	Unit
Supply voltages				
VDD		-0.3	+3.9	V
VSS			0	V
I/O pin voltage				
$V_{I/O}$, VDD \leq 3.6 V		-0.3	VDD + 0.3	V
$V_{I/O}$, VDD $>$ 3.6 V		-0.3	3.9	V
Radio				
RF input level			10	dBm
Environmental QFN package				
Storage temperature		-40	+125	°C
MSL	Moisture Sensitivity Level		2	
ESD HBM	Human Body Model		4	kV
ESD HBM Class	Human Body Model Class		3A	
ESD CDM	Charged Device Model		1	kV
Flash memory				
Endurance		10 000		Write/erase cycles
Retention		10 years at 40°C		

8.2. Operation Conditions

Symbol	Parameter	Min.	Nom.	Max.	Units
VDD	Supply voltage, independent of DCDC enable	1.7	3.0	3.6	V
t_{R_VDD}	Supply rise time (0 V to 1.7 V)			60	ms
TA	Operating temperature	-40	25	85	°C

Important: The on-chip power-on reset circuitry may not function properly for rise times longer than the specified maximum.

8.3. Electrical Specifications

8.3.1. General Radio Characteristics

Symbol	Description	Min.	Typ.	Max.	Units
f_{OP}	Operating frequencies	2360		2500	MHz
$f_{PLL,PROG,RES}$	PLL programming resolution		2		kHz
$f_{PLL,CH,SP}$	PLL channel spacing		1		MHz
$f_{DELTA,1M}$	Frequency deviation @ 1 Mbps		± 170		kHz
$f_{DELTA,BLE,1M}$	Frequency deviation @ BLE 1 Mbps		± 250		kHz
$f_{DELTA,2M}$	Frequency deviation @ 2 Mbps		± 320		kHz
$f_{DELTA,BLE,2M}$	Frequency deviation @ BLE 2 Mbps		± 500		kHz
f_{skSPS}	On-the-air data rate	1		2	Mbps

8.3.2. Radio Current Consumption (Transmitter)

Symbol	Description	Min.	Typ.	Max.	Units
$I_{TX,PLUS4dBm,DCDC}$	TX only run current (DCDC, 3V) $P_{RF} = +4$ dBm		7.0		mA
$I_{TX,PLUS4dBm}$	TX only run current $P_{RF} = +4$ dBm		15.4		mA
$I_{TX,0dBm,DCDC}$	TX only run current (DCDC, 3V) $P_{RF} = 0$ dBm		4.6		mA
$I_{TX,0dBm}$	TX only run current $P_{RF} = 0$ dBm		10.1		mA
$I_{TX,MINUS4dBm,DCDC}$	TX only run current DCDC, 3V $P_{RF} = -4$ dBm		3.6		mA
$I_{TX,MINUS4dBm}$	TX only run current $P_{RF} = -4$ dBm		7.8		mA
$I_{TX,MINUS8dBm,DCDC}$	TX only run current DCDC, 3V $P_{RF} = -8$ dBm		3.2		mA
$I_{TX,MINUS8dBm}$	TX only run current $P_{RF} = -8$ dBm		6.8		mA
$I_{TX,MINUS12dBm,DCDC}$	TX only run current DCDC, 3V $P_{RF} = -12$ dBm		2.9		mA
$I_{TX,MINUS12dBm}$	TX only run current $P_{RF} = -12$ dBm		6.2		mA
$I_{TX,MINUS16dBm,DCDC}$	TX only run current DCDC, 3V $P_{RF} = -16$ dBm		2.7		mA
$I_{TX,MINUS16dBm}$	TX only run current $P_{RF} = -16$ dBm		5.7		mA
$I_{TX,MINUS20dBm,DCDC}$	TX only run current DCDC, 3V $P_{RF} = -20$ dBm		2.5		mA
$I_{TX,MINUS20dBm}$	TX only run current $P_{RF} = -20$ dBm		5.4		mA
$I_{TX,MINUS40dBm,DCDC}$	TX only run current DCDC, 3V $P_{RF} = -40$ dBm		2.1		mA
$I_{TX,MINUS40dBm}$	TX only run current $P_{RF} = -40$ dBm		4.3		mA

8.3.3. Radio Current Consumption (Receiver)

Symbol	Description	Min.	Typ.	Max.	Units
I _{RX,1M,DCDC}	RX only run current (DCDC, 3V) 1 Mbps / 1 Mbps BLE		4.6		mA
I _{RX,1M}	RX only run current 1 Mbps / 1 Mbps BLE		10.0		mA
I _{RX,2M,DCDC}	RX only run current (DCDC, 3V) 2 Mbps / 2 Mbps BLE		5.2		mA
I _{RX,2M}	RX only run current 2 Mbps / 2 Mbps BLE		11.2		mA
I _{START,RX,1M,DCDC}	RX start-up current (DCDC, 3 V) 1 Mbps / 1 Mbps BLE		3.5		mA
I _{START,RX,1M}	RX start-up current 1 Mbps / 1 Mbps BLE		6.7		mA

8.3.4. Transmitter Specification

Symbol	Description	Min.	Typ.	Max.	Units
P _{RF}	Maximum output power		4	8	dBm
P _{RFC}	RF power control range		24		dB
P _{RFRCR}	RF power accuracy			±4	dB
P _{RF1,1}	1st Adjacent Channel Transmit Power 1 MHz (1 Mbps)		-25		dBc
P _{RF2,1}	2nd Adjacent Channel Transmit Power 2 MHz (1 Mbps)		-50		dBc
P _{RF1,2}	1st Adjacent Channel Transmit Power 2 MHz (2 Mbps)		-25		dBc
P _{RF2,2}	2nd Adjacent Channel Transmit Power 4 MHz (2 Mbps)		-50		dBc

8.3.5. Receiver Operation

Symbol	Description	Min.	Typ.	Max.	Units
P _{RX,MAX}	Maximum received signal strength at < 0.1% BER		0		dBm
P _{SENS,IT,1M}	Sensitivity, 1 Mbps nRF mode ¹		-93		dBm
P _{SENS,IT,SP,1M,BLE}	Sensitivity, 1 Mbps BLE ideal transmitter, <=37 bytes BER=1E-3 ²		-96		dBm
P _{SENS,IT,LP,1M,BLE}	Sensitivity, 1 Mbps BLE ideal transmitter >=128 bytes BER=1E-4 ³		-95		dBm
P _{SENS,IT,2M}	Sensitivity, 2 Mbps nRF mode ⁴		-89		dBm
P _{SENS,IT,SP,2M,BLE}	Sensitivity, 2 Mbps BLE ideal transmitter, Packet length <=37bytes		-93		dBm

1. Typical sensitivity applies when ADDR0 is used for receiver address correlation. When ADDR [1...7] are used for receiver address correlation, the typical sensitivity for this mode is degraded by 3dB.
2. As defined in the Bluetooth Core Specification v4.0 Volume 6: Core System Package (Low Energy Controller Volume).
3. Equivalent BER limit < 10E-04.
4. Same as remark 1.

8.3.6. RX Selectivity

Symbol	Description	Min.	Typ.	Max.	Units
$C/I_{1M,co-channel}$	1 Mbps mode, Co-Channel interference		9		dB
$C/I_{1M,-1MHz}$	1 Mbps mode, Adjacent (-1 MHz) interference		-2		dB
$C/I_{1M,+1MHz}$	1 Mbps mode, Adjacent (+1 MHz) interference		-10		dB
$C/I_{1M,-2MHz}$	1 Mbps mode, Adjacent (-2 MHz) interference		-19		dB
$C/I_{1M,+2MHz}$	1 Mbps mode, Adjacent (+2 MHz) interference		-42		dB
$C/I_{1M,-3MHz}$	1 Mbps mode, Adjacent (-3 MHz) interference		-38		dB
$C/I_{1M,+3MHz}$	1 Mbps mode, Adjacent (+3 MHz) interference		-48		dB
$C/I_{1M,\pm 6MHz}$	1 Mbps mode, Adjacent (≥ 6 MHz) interference		-50		dB
$C/I_{1MBLE,co-channel}$	1 Mbps BLE mode, Co-Channel interference		6		dB
$C/I_{1MBLE,-1MHz}$	1 Mbps BLE mode, Adjacent (-1 MHz) interference		-2		dB
$C/I_{1MBLE,+1MHz}$	1 Mbps BLE mode, Adjacent (+1 MHz) interference		-9		dB
$C/I_{1MBLE,-2MHz}$	1 Mbps BLE mode, Adjacent (-2 MHz) interference		-22		dB
$C/I_{1MBLE,+2MHz}$	1 Mbps BLE mode, Adjacent (+2 MHz) interference		-46		dB
$C/I_{1MBLE,>3MHz}$	1 Mbps BLE mode, Adjacent (≥ 3 MHz) interference		-50		dB
$C/I_{1MBLE,image}$	Image frequency Interference		-22		dB
$C/I_{1MBLE,image,1MHz}$	Adjacent (1 MHz) interference to in-band image frequency		-35		dB
$C/I_{2M,co-channel}$	2 Mbps mode, Co-Channel interference		10		dB
$C/I_{2M,-2MHz}$	2 Mbps mode, Adjacent (-2 MHz) interference		6		dB
$C/I_{2M,+2MHz}$	2 Mbps mode, Adjacent (+2 MHz) interference		-14		dB
$C/I_{2M,-4MHz}$	2 Mbps mode, Adjacent (-4 MHz) interference		-20		dB
$C/I_{2M,+4MHz}$	2 Mbps mode, Adjacent (+4 MHz) interference		-44		dB
$C/I_{2M,-6MHz}$	2 Mbps mode, Adjacent (-6 MHz) interference		-42		dB
$C/I_{2M,+6MHz}$	2 Mbps mode, Adjacent (+6 MHz) interference		-47		dB
$C/I_{2M,\geq 12MHz}$	2 Mbps mode, Adjacent (≥ 12 MHz) interference		-52		dB

Remark: Wanted signal level at PIN = -67 dBm. One interferer is used, having equal modulation as the wanted signal. The input power of the interferer where the sensitivity equals BER = 0.1% is presented.



8.3.7. RX Intermodulation

Symbol	Description	Min.	Typ.	Max.	Units
P _{IMD,5TH,1M}	IMD performance, 1 Msps, 5th offset channel, Packet length <= 37 bytes		-33		dBm
P _{IMD,5TH,1M,BLE}	IMD performance, BLE 1 Msps, 5th offset channel, Packet length <= 37 bytes		-30		dBm
P _{IMD,5TH,2M}	IMD performance, 2 Msps, 5th offset channel, Packet length <= 37 bytes		-33		dBm
P _{IMD,5TH,2M,BLE}	IMD performance, BLE 2 Msps, 5th offset channel, Packet length <= 37 bytes		-31		dBm

Remark: Wanted signal level at PIN = -64dBm. Two interferers with equal input power are used. The interferer closest in frequency is not modulated, the other interferer is modulated equal with the wanted signal. The input power of the interferers where the sensitivity equals BER = 0.1% is presented.

8.3.8. Radio Timing Parameters

Symbol	Description	Min.	Typ.	Max.	Units
t _{TXEN}	Time between TXEN task and READY event after channel FREQUENCY configured. Compatible with old devices.	140		140	μs
t _{TXEN,FAST}	Time between TXEN task and READY event after channel FREQUENCY configured (Fast Mode)	40		40	μs
t _{TXDISABLE,1M}	Time between DISABLE task and DISABLED event when the radio was in TX for MODE = Nrf_1Mbit and MODE = Ble_1Mbit	6		6	μs
t _{TXDISABLE,2M}	Time between DISABLE task and DISABLED event when the radio was in TX and mode is set to 2 Mbps	4		4	μs
t _{RXEN}	Time between the RXEN task and READY event after channel FREQUENCY configured in default mode. Compatible with old devices.	140		140	μs
t _{RXEN,FAST}	Time between the RXEN task and READY event after channel FREQUENCY configured in fast mode	40		40	μs
t _{SWITCH}	The minimum time taken to switch from RX to TX or TX to RX when channel FREQUENCY unchanged		20		μs
t _{RXDISABLE}	Time between DISABLE task and DISABLED event when the radio was in RX	0		0	μs
t _{TXCHAIN}	Digital propagation delay (in radio only) when transmitting. Does not include EasyDMA access time.		0.6		μs
t _{RXCHAIN}	Digital propagation delay (in radio only) when receiving. Does not include EasyDMA access time.		9.4		μs
t _{RXCHAIN,2M}	Digital propagation delay in 2 Mbps mode (radio only) when receiving. Does not include EasyDMA access time.		5		μs

8.3.9. RSSI Specifications

Symbol	Description	Min.	Typ.	Max.	Units
RSSI _{ACC}	RSSI Accuracy Valid range -90 to -20 dBm		±2		dB
RSSI _{RESOLUTION}	RSSI resolution		1		dB
RSSI _{PERIOD}	Sample period		0.25		us

8.3.10. CPU

Symbol	Description	Min.	Typ.	Max.	Units
W _{FLASH}	CPU wait states, running from flash	0		2	
W _{RAM}	CPU wait states, running from RAM			0	
CM _{FLASH}	CoreMark ¹ , running from flash		144		CoreMark
CM _{FLASH/MHz}	CoreMark per MHz, running from flash		2.25		CoreMark/MHz
CM _{FLASH/mA}	CoreMark per mA, running from flash, DCDC 3V		65		CoreMark/mA

8.3.11. Power Management

Symbol	Description	Min.	Typ.	Max.	Units
I _{ON_RAMOFF_EVENT}	System ON, No RAM retention, Wake on any event		0.6		μA
I _{ON_RAMON_EVENT}	System ON, Full 24 kB RAM retention, Wake on any event		0.8		μA
I _{ON_RAMON_POF}	System ON, Full 24 kB RAM retention, Wake on any event, Power fail comparator enabled		0.8		μA
I _{ON_RAMON_GPIOTE}	System ON, Full 24 kB RAM retention, Wake on GPIOTE input (Event mode)		3.3		μA
I _{ON_RAMON_GPIOTEPORT}	System ON, Full 24 kB RAM retention, Wake on GPIOTE PORT event		0.8		μA
I _{ON_RAMON_RTC}	System ON, Full 24 kB RAM retention, Wake on RTC (running from LFRC clock)		1.5		μA
I _{ON_RAMOFF_RTC}	System ON, No RAM retention, Wake on RTC (running from LFRC clock)		1.4		μA
I _{ON_RAMON_RTC_LFXO}	System ON, Full 24 kB RAM retention, Wake on RTC (running from LFXO clock)		1.1		μA
I _{ON_RAMOFF_RTC_LFXO}	System ON, No RAM retention, Wake on RTC (running from LFXO clock)		1.0		μA
I _{OFF_RAMOFF_RESET}	System OFF, No RAM retention, Wake on reset		0.3		μA
I _{OFF_RAMON_RESET}	System OFF, Full 24 kB RAM retention, Wake on reset		0.5		μA

9. Antenna

9.1. MDBT42Q Series

Test Result

Frequency (MHz)	2400	2410	2420	2430	2440	2450	2460	2470	2480	2490	2500
Gain (dBi)	-3.68	-2.91	-2.34	-1.98	-1.66	-1.60	-1.77	-2.09	-2.60	-3.35	-4.10
Peak EIRP (dBm)	-3.68	-2.91	-2.34	-1.98	-1.66	-1.60	-1.77	-2.09	-2.60	-3.35	-4.10
Directivity (dBi)	4.98	5.11	5.12	5.02	4.93	4.76	4.58	4.38	4.11	3.77	3.42

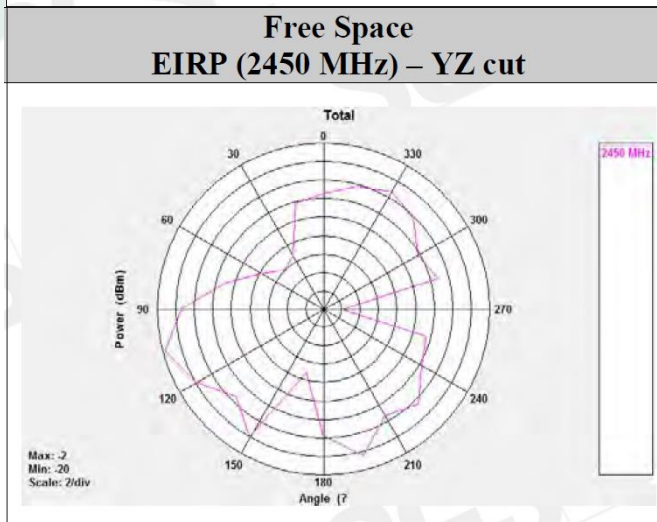
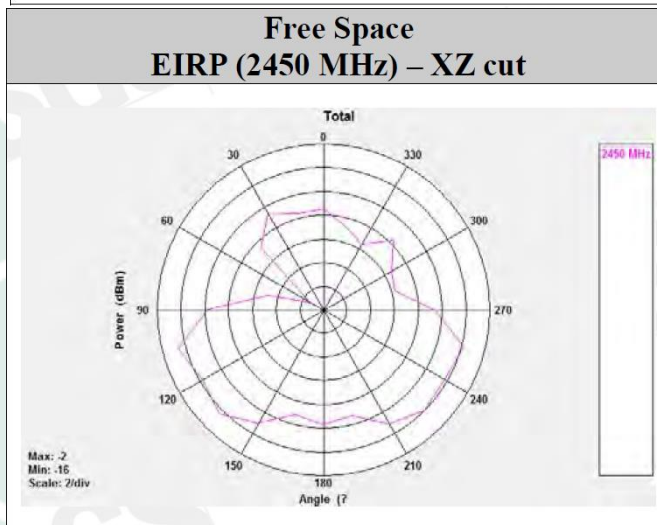
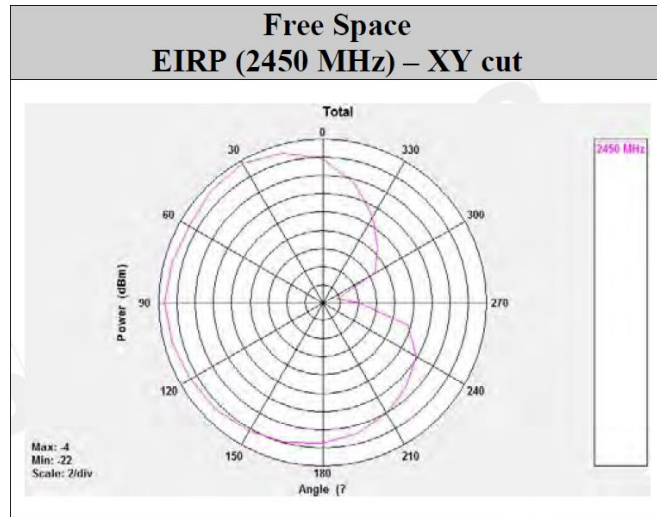

9.2. MDBT42Q-P Series

Test Result

Frequency (MHz)	2400	2410	2420	2430	2440	2450	2460	2470	2480	2490	2500
Gain (dBi)	-3.87	-3.06	-2.31	-2.01	-2.04	-2.31	-2.24	-1.96	-1.61	-1.71	-1.97
Peak EIRP (dBm)	-3.87	-3.06	-2.31	-2.01	-2.04	-2.31	-2.24	-1.96	-1.61	-1.71	-1.97
Directivity (dBi)	3.79	4.00	4.25	4.17	3.86	3.51	3.54	3.91	4.39	4.44	4.49

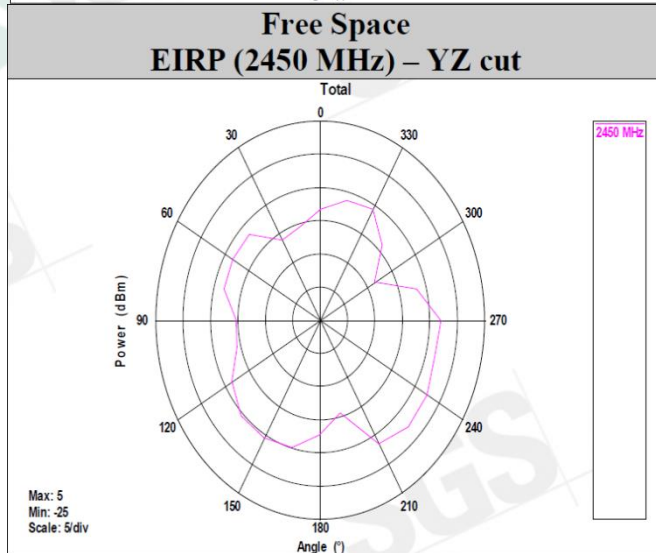
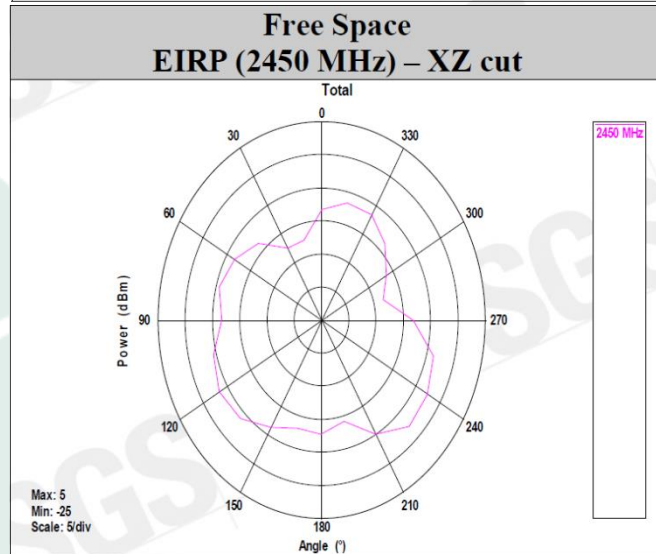
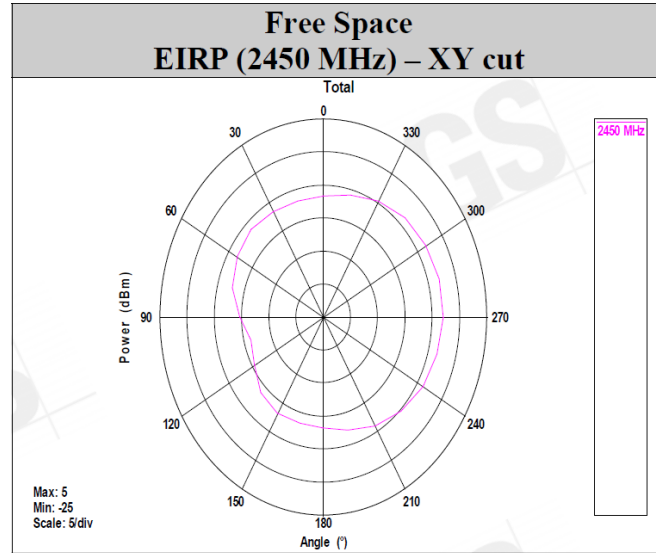

10. Reference Circuit

Module is pre-programmed with Raytac's AT command firmware. Default is "LDO mode" and is using internal 32.768khz RC oscillator.

REMARK:

**** When using DC-DC mode, please add L2 / L3 / C14. ****

**** When **NOT** using internal 32.768khz RC oscillator, please add X2 / C12 / C13. ****

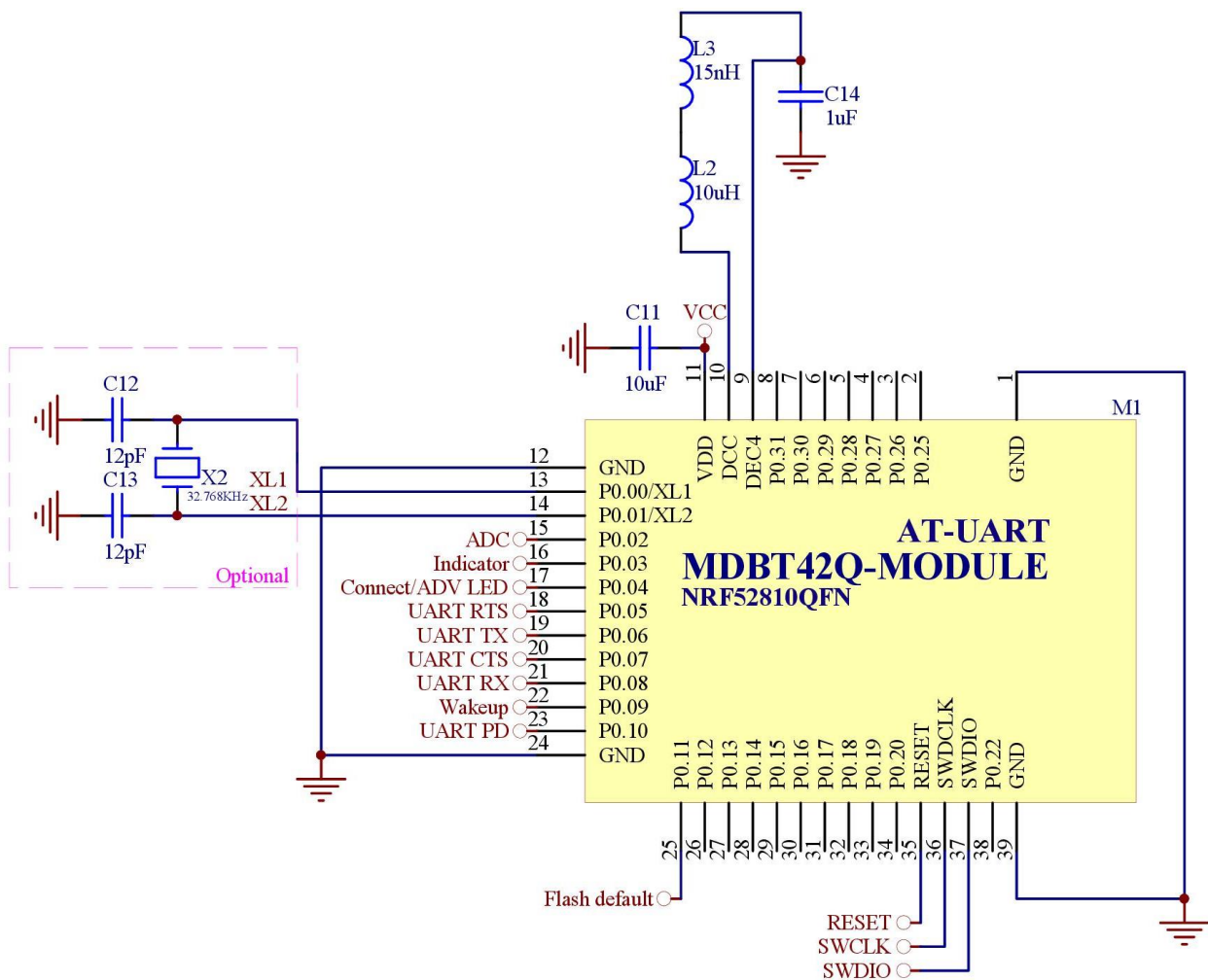

11. Certification

11.1. Declaration ID

BT 5.1

Declaration ID	QDID(s)	Company	Specification Name
D047708	139361 - End Product	Raytac Corporation	5.1

BT 5.2

Declaration ID	QDID(s)	Company	Specification Name
D053149	159932 - End Product	Raytac Corporation	5.2



11.2. FCC Certificate (USA)

BLE 1 Mbps



TCB

**GRANT OF EQUIPMENT
AUTHORIZATION**
Certification
Issued Under the Authority of the
Federal Communications Commission
By:

TCB

Raytac Corp.
5F., No.3, Jiankang Rd., Zhonghe Dist.,
New Taipei City,, 23586
Taiwan

Attention: Venson Liao , R&D Manager

Telefication B.V.
Edisonstraat 12a
Zevenaar, NL-6902 PK
Netherlands

Date of Grant: 02/21/2017

Application
Dated: 02/21/2017

NOT TRANSFERABLE

EQUIPMENT AUTHORIZATION is hereby issued to the named GRANTEE, and is VALID ONLY for the equipment identified hereon for use under the Commission's Rules and Regulations listed below.

FCC IDENTIFIER:	SH6MDBT42Q
Name of Grantee:	Raytac Corp.
Equipment Class:	Digital Transmission System
Notes:	BT 4.2 Module
Modular Type:	Single Modular

Grant Notes	FCC Rule Parts	Frequency Range (MHZ)	Output Watts	Frequency Emission Tolerance Designator
	15C	2402.0 - 2480.0	0.0023	

C2PC: To change module to be certified under portable device.
Power output listed is conducted. This grant is valid only when the module is sold to OEM integrators and must be installed by the OEM or OEM integrators. The antenna's as listed in this application must not be co-located or operating in conjunction with any other antenna or transmitter. End-users may not be provided with the module installation instructions. OEM integrators and end-users must be provided with transmitter operating conditions for satisfying RF exposure compliance.

Certificate No.: 162181172/AA/01	Mohammad Elhaj Product Assessor	
-------------------------------------	------------------------------------	---

BLE 2 Mbps



TCB

TCB

**GRANT OF EQUIPMENT
AUTHORIZATION**

Certification
Issued Under the Authority of the
Federal Communications Commission
By:

Telefication B.V.
Edisonstraat 12a
Zevenaar, NL-6902 PK
Netherlands

Date of Grant: 01/02/2018

Application
Dated: 12/18/2017

Raytac Corp.
5F., No.3, Jiankang Rd., Zhonghe Dist.,
New Taipei City., 23586
Taiwan

Attention: Venson Liao , R&D Manager

NOT TRANSFERABLE

EQUIPMENT AUTHORIZATION is hereby issued to the named
GRANTEE, and is VALID ONLY for the equipment identified hereon for
use under the Commission's Rules and Regulations listed below.

FCC IDENTIFIER: SH6MDBT42Q
Name of Grantee: Raytac Corp.
Equipment Class: Digital Transmission System
Notes: BLE Module
Modular Type: Single Modular

Grant Notes	FCC Rule Parts	Frequency Range (MHZ)	Output Watts	Frequency Emission Tolerance Designator
	15C	2402.0 - 2480.0	0.0023	

C2PC: add BT5.0 by Firmware and change product name to BLE module from BT 4.2 module. To change module to be certified under portable device.

Power output listed is conducted. This grant is valid only when the module is sold to OEM integrators and must be installed by the OEM or OEM integrators. The antenna's as listed in this application must not be co-located or operating in conjunction with any other antenna or transmitter. End-users may not be provided with the module installation instructions. OEM integrators and end-users must be provided with transmitter operating conditions for satisfying RF exposure compliance.

Certificate No.: 162181172/AA/02	George Lo Product Assessor	
-------------------------------------	-------------------------------	--

11.3. TELEC Certificate (Japan)

BLE 1 Mbps

telefication bv
The Netherlands
Chamber of Commerce
51565536
www.telefication.com

 **telefication**

Certificate
of
Radio Equipment in JAPAN

No: 201-160496 / 00

Telefication, operating as Conformity Assessment Body (CAB ID Number: 201) with respect to Japan, declares that the listed product complies with the Technical Regulations Conformity Certification of Terminal equipment (ordinance of MPT N° 31,1984)

Product description: BT 4.2 Module
Trademark: Raytac
Type designation: MDBT42Q
Hardware / Software version: 1 / 1
Variants: See Annex 3

Manufacturer: Raytac Corporation
Address: 5F, No.3, Jiankang Rd., Zhonghe Dist.,
City: New Taipei 23586
Country: Taiwan

This statement is granted to:

Name: Raytac Corporation
Address: 5F, No.3, Jiankang Rd., Zhonghe Dist.,
City: New Taipei 23586
Country: Taiwan

This statement has THREE Annexes.

Zevenaar, 19 August 2016

CAB

Ramy Nabod
Product Assessor

PRODUCTS
RvA C 224

BLE 2 Mbps

telefication bv
The Netherlands
Chamber of Commerce
51565536
www.telefication.com



Certificate

of
Radio Equipment in JAPAN

No: 201-160496 / 02

Telefication, operating as Conformity Assessment Body (CAB ID Number: 201) with respect to Japan, declares that the listed product complies with the Technical Regulations Conformity Certification of Specified Radio equipment (ordinance of MPT N° 37,1981)

Product description: **BLE Module**
Trademark: **Raytac**
Type designation: **MDBT42Q**
Hardware / Software version: **1 / 1**
Variants: **See Annex 3**

Manufacturer: **Raytac Corporation**
Address: **5F, No. 3, Jiankang Rd., Zhonghe Dist.**
City: **23586 New Taipei City**
Country: **Taiwan**

This certificate is granted to:

Name: **Raytac Corporation**
Address: **5F, No. 3, Jiankang Rd., Zhonghe Dist.**
City: **23586 New Taipei City**
Country: **Taiwan**

This certificate has **THREE** Annexes.

Zevenaar, 23 May 2019

CAB

David Chen

David Chen
Product Assessor



11.4. NCC Certificate (Taiwan)

MDBT42Q Series

BLE 1 Mbps & 2 Mbps

國家通訊傳播委員會 電信管制射頻器材型式認證證明

- 一、申請者：勁達國際電子有限公司
- 二、地址：臺北市大安區和平東路1段145號5樓之1
- 三、製造廠商：勁達國際電子有限公司
- 四、器材名稱：BLE Module
- 五、廠牌：Raytac
- 六、型號：MDBT42Q
- 七、發射功率(電場強度)：詳細射頻規格如備註欄
- 八、工作頻率：詳細射頻規格如備註欄
- 九、審驗日期：105年08月19日(換證日期：108年06月19日)

十、審驗合格標籤式樣：

 CCAM16LP1180T2



十一、警語或標示要求：(器材本體、使用手冊、外包裝盒等應遵守下列標示要求)

1. 應依審驗合格標籤或符合性聲明標籤式樣自製標籤黏貼或印鑄於電信管制射頻器材本體明顯處，並於包裝盒標示本會標章，始得開陳列或販賣。
2. 電信管制射頻器材應依本會或相關技術規範規定於指定位置標示中文警語。
3. 經授權使用射頻模組(組件)之審驗合格標籤者，應於最終產品說明書及包裝盒提供充分與正確之資訊。
4. 於網際網路販賣取得審驗證明之電信管制射頻器材者，應於該網際網路網頁提供審驗合格標籤或符合性聲明標籤資訊。
5. 使用手冊應標示下列資訊：
(1)經型式認證合格之低功率射頻電機，非經許可，公司、商號或使用者均不得擅自變更頻率、加大功率或變更原設計之特性及功能。低功率射頻電機之使用不得影響飛航安全及干擾合法通信；經發現有干擾現象時，應立即停用，並改善至無干擾時方得繼續使用。前項合法通信，指依電信法規定作業之無線電通信。低功率射頻電機須忍受合法通信或工業、科學及醫療用電波輻射性電機設備之干擾。
6. 本器材之審驗範圍僅限無線射頻硬體功能，不及於器材之資通安全檢測。

型式認證號碼：CCAM16LP1180T2

第 1 頁，共 2 頁

本證書與續頁分開使用無效

MDBT42Q-P Series

BLE 1 Mbps & 2 Mbps

國家通訊傳播委員會 電信管制射頻器材型式認證證明

- 一、申請者：勁達國際電子有限公司
- 二、地址：臺北市大安區和平東路1段145號5樓之1
- 三、製造廠商：勁達國際電子有限公司
- 四、器材名稱：BLE Module
- 五、廠牌：Raytac
- 六、型號：MDBT42Q-P
- 七、發射功率(電場強度)：詳細射頻規格如備註欄
- 八、工作頻率：詳細射頻規格如備註欄
- 九、審驗日期：105年08月19日(換證日期：108年06月19日)

- 十、審驗合格標籤式樣：







- 十一、警語或標示要求：(器材本體、使用手冊、外包裝盒等應遵守下列標示要求)

1. 應依審驗合格標籤或符合性聲明標籤式樣自製標籤黏貼或印鑄於電信管制射頻器材本體明顯處，並於包裝盒標示本會標章，始得開陳列或販賣。
2. 電信管制射頻器材應依本會或相關技術規範規定於指定位置標示中文警語。
3. 經授權使用射頻模組(組件)之審驗合格標籤者，應於最終產品說明書及包裝盒提供充分與正確之資訊。
4. 於網際網路販賣取得審驗證明之電信管制射頻器材者，應於該網際網路網頁提供審驗合格標籤或符合性聲明標籤資訊。
5. 使用手冊應標示下列資訊：
 - (1)經型式認證合格之低功率射頻電機，非經許可，公司、商號或使用者均不得擅自變更頻率、加大功率或變更原設計之特性及功能。低功率射頻電機之使用不得影響飛航安全及干擾合法通信；經發現有干擾現象時，應立即停用，並改善至無干擾時方得繼續使用。前項合法通信，指依電信法規定作業之無線電通信。低功率射頻電機須忍受合法通信或工業、科學及醫療用電波輻射性電機設備之干擾。
6. 本器材之審驗範圍僅限無線射頻硬體功能，不及於器材之資通安全檢測。

11.5. CE Test Report (EU)

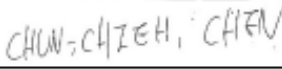
BLE 1 Mbps & 2 Mbps

		Report No.: ER/2016/70008-05 Page: 1 of 53
		
RED (2014/53/EU)		
ETSI EN 300 328 V2.2.2 : 2019		
TEST REPORT		
<hr/>		
FOR		
Applicant:	Raytac Corporation 5F, No.3, Jiankang Rd., Zhonghe Dist., New Taipei City , 23586, Taiwan	
Product Name:	BLE Module	
Brand Name:	Raytac	
Model No.:	MDBT42Q, MDBT42Q-P	
Model Difference:	MDBT42Q with Chip antenna, MDBT42Q-P with PCB antenna	
Report Number:	ER/2016/70008-05	
Issue Date:	May 15, 2020	
Date of Test:	Jul. 04, 2016 ~ Nov. 28, 2017 (Original) Apr. 16, 2020 ~May 04, 2020 (Updated)	
Date of EUT Received:	Jul. 04, 2016 (Original) Apr. 16, 2020(Updated)	
We hereby certify that:	The above equipment was tested by SGS Taiwan Ltd., Electronics & Communication Laboratory for compliance with the requirements set forth in the European Standard ETSI EN 300 328 V2.2.2: 2019 under RED 2014/53/EU. The results of testing in this report apply to the product system that was tested only. Other similar equipment will not necessarily produce the same results due to production tolerance and measurement uncertainties.	
Approved By:	 Chun Chieh Chen / Supervisor	
		



SGS Reference No: MH/2019/40103C

VERIFICATION OF EMC COMPLIANCE

Verification No. : MH/2019/40103C
Representative Model No. : MDBT42Q
Added Model(s) : MDBT42Q-P, MDBT42Q-U
Product Name : BLE Module
Brand Name : Raytac
Applicant : Raytac Corporation
Address of Applicant : 5F, No.3, Jiankang Rd., Zhonghe Dist., New Taipei City , 23586, Taiwan
Test Report Number : MH/2019/40103
Date of Issue : May 13, 2019
Applicable Standards : EN 301 489 –1 v2.2.0 : 2017-03 (Draft)
EN 301 489 –17 v3.2.0 : 2017-03 (Draft)
EN 55032 : 2015+AC:2016-07
EN 61000-4-2 : 2009, EN 61000-4-3 : 2006+A1:2008+A2:2010

Conclusion

The apparatus meets the requirements of the above standards and hence compliance the essential requirements under article 3.1b of the RED (2014/53/EU) Directive.

*This verification is only valid for the equipment and configuration described, and in conjunction with the test report as detailed above.

Authorized Signatory:

SGS TAIWAN LTD.
Eddy Cheng
Technical Asst. Supervisor

11.6. IC Certificate (Canada)

BLE 1 Mbps

telefication bv The Netherlands Chamber of Commerce 51565536 www.telefication.com			
TECHNICAL ACCEPTANCE CERTIFICATE		CERTIFICAT D'ACCEPTABILITÉ TECHNIQUE	
CERTIFICATION No. No. DE CERTIFICATION	8017A-MDBT42Q		
TELEFICATION No. No. DE TELEFICATION	162170280/AA/01		
TEST SITE No. No. DE LABORATOIRE	4620A-5		
ISSUED TO DÉLIVRÉ A	Raytac Corporation		
TYPE OF EQUIPMENT GENRE DE MATÉRIEL	Bluetooth device		
TRADE NAME AND MODEL MARQUE ET MODELE	Raytac / MDBT42Q Raytac / MDBT42Q-P		
CERTIFIED TO CERTIFIÉ SELON LE	SPECIFICATION CAHIER DES CHARGES	RSS-102 RSS-247	ISSUE EDITION 5 1
Certification of equipment means only that the equipment has met the requirements of the above-noted specification. Licence applications, where applicable to use certified equipment, are acted on accordingly by the Industry Canada issuing office and will depend on the existing radio environment, service and location of operation. This certificate is issued on condition that the holder complies and will continue to comply with the requirements and procedures issued by Industry Canada. The equipment for which this certificate is issued shall not be manufactured, imported, distributed, leased, offered for sale or sold unless the equipment complies with the applicable technical specifications and procedures issued by Industry Canada.		La certification du matériel signifie seulement que le matériel a satisfait aux exigences de la norme indiquée ci-dessus. Les demandes de licences nécessaires pour l'utilisation du matériel certifié sont traitées en conséquence par le bureau de délivrance d'Industrie Canada et dépendent des conditions radio ambiantes, du service et de l'emplacement d'exploitation. Le présent certificat est délivré à la condition que le titulaire satisfasse et continue de satisfaire aux exigences et aux procédures d'Industrie Canada. Le matériel à l'égard duquel le présent certificat est délivré ne doit pas être fabriqué, importé, distribué, loué, mis en vente ou vendu à moins d'être conforme aux procédures et aux spécifications techniques applicables publiées par Industrie Canada.	
ISSUED BY TELEFICATION BV, RECOGNIZED CERTIFICATION BODY BY INDUSTRY CANADA DÉLIVRÉ PAR TELEFICATION BV, ORGANISME DE CERTIFICATION RECONNU PAR INDUSTRIE CANADA			
<i>I hereby attest that the subject equipment was tested and found in compliance with the above-noted specification. J'atteste, par la présente, que le matériel a fait l'objet d'essai et a été jugé conforme à la spécification ci-dessus</i>			
DATE 21 Feb 2017 BY	Mohammad Elhaj Product Assessor		
This certificate has one annex.			

BLE 2 Mbps

telefication bv
The Netherlands
Chamber of Commerce
51565536
www.telefication.com



TECHNICAL ACCEPTANCE CERTIFICATE

CERTIFICAT D'ACCEPTABILITÉ TECHNIQUE

CERTIFICATION No. No. DE CERTIFICATION	8017A-MDBT42Q			
TELEFICATION No. No. DE TELEFICATION	162170280/AA/02			
TEST SITE No. No. DE LABORATOIRE	4620A-5			
ISSUED TO DELIVRÉ A	Raytac Corporation			
TYPE OF EQUIPMENT GENRE DE MATÉRIEL	Bluetooth device			
TRADE NAME AND MODEL MARQUE ET MODELE	Raytac / MDBT42Q Raytac / MDBT42Q-P			
CERTIFIED TO CERTIFIÉ SELON LE	SPECIFICATION CAHIER DES CHARGES	RSS-102 RSS-247	ISSUE EDITION	5 2

Certification of equipment means only that the equipment has met the requirements of the above-noted specification. Licence applications, where applicable to use certified equipment, are acted on accordingly by the ISED issuing office and will depend on the existing radio environment, service and location of operation. This certificate is issued on condition that the holder complies and will continue to comply with the requirements and procedures issued by ISED. The equipment for which this certificate is issued shall not be manufactured, imported, distributed, leased, offered for sale or sold unless the equipment complies with the applicable technical specifications and procedures issued by ISED.

La certification du matériel signifie seulement que le matériel a satisfait aux exigences de la norme indiquée ci-dessus. Les demandes de licences nécessaires pour l'utilisation du matériel certifié sont traitées en conséquence par le bureau de délivrance d'ISDE et dépendent des conditions radio ambiantes, du service et de l'emplacement d'exploitation. Le présent certificat est délivré à la condition que le titulaire satisfasse et continue de satisfaire aux exigences et aux procédures d'ISDE. Le matériel à l'égard duquel le présent certificat est délivré ne doit pas être fabriqué, importé, distribué, loué, mis en vente ou vendu à moins d'être conforme aux procédures et aux spécifications techniques applicables publiées par ISDE.

ISSUED BY TELEFICATION BV (NL0001), RECOGNIZED CERTIFICATION BODY BY INNOVATION, SCIENCE AND ECONOMIC DEVELOPMENT CANADA
DELIVRÉ PAR TELEFICATION BV (NL0001), ORGANISME DE CERTIFICATION RECONNU PAR INNOVATION, SCIENCES ET DEVELOPPEMENT ECONOMIQUE CANADA

*I hereby attest that the subject equipment was tested and found in compliance with the above-noted specification.
J'atteste, par la présente, que le matériel a fait l'objet d'essai et a été jugé conforme à la spécification ci-dessus*

DATE 02 Jan 2018 BY

George Lo
Product Assessor

This certificate has one annex.



11.7. SRRC Certificate (China)

BLE 1 Mbps & 2 Mbps



11.8. KC Certificate (South Korea)

BLE 1 Mbps & 2 Mbps

B58D-F9C0-417D-C63A

방송통신기자재등의 적합인증서 <i>Certificate of Broadcasting and Communication Equipments</i>	
상호 또는 성명 <i>Trade Name or Applicant</i>	Raytac Corporation
기자재 명칭 <i>Equipment Name</i>	특정소출력 무선기기(무선데이터통신시스템용 무선기기)
기본모델명 <i>Basic Model Number</i>	MDBT42Q
파생모델명 <i>Series Model Number</i>	MDBT42Q-P
인증번호 <i>Certification No.</i>	MSIP-CRM-ryt-MDBT42Q
제조사/제조국가 <i>Manufacturer/ Country of Origin</i>	Raytac Corporation / 대만
인증연월일 <i>Date of Certification</i>	2016-10-06
기타 <i>Others</i>	
<p>위 기자재는 「전파법」 제58조의2 제2항에 따라 인증되었음을 증명합니다.</p> <p>It is verified that foregoing equipment has been certificated under the Clause 2, Article 58-2 of Radio Waves Act.</p> <p style="text-align: right;">2016년 (Year) 10월 (Month) 06일 (Date)</p> <p style="text-align: center;">국립전파연구원장</p> <p style="text-align: center;">  <i>Director General of National Radio Research Agency</i> </p> <p>※ 인증 받은 방송통신기자재는 반드시 "적합성평가표시" 를 부착하여 유통하여야 합니다. 위반시 과태료 처분 및 인증이 취소될 수 있습니다.</p>	

11.9. RoHS & REACH Report

Please visit "[Support](#)" page of our website to download.

11.10. End-Product Label

It is suggested using following content adding to package or user manual or label to obey the regulation. Any rules of end-product label shall refer to each certification for final reference.

11.10.1. FCC (USA)

The FCC statement should be included in the user manual when there is no enough space on label. Otherwise, it should be included on the label.

"This device complies with part 15 of the FCC rules. Operation is subject to the following two conditions. (1) This device may not cause harmful interference. (2) This device must accept any interference received, including interference that may cause undesired operation."

The final end product must be labeled in a visible area with the following: "Contain FCC ID: SH6MDBT42Q".

11.10.2. TELEC (Japan)

When manufacturer is placing the product on the Japanese market, the product must be affixed with the following Specified Radio Equipment marking:

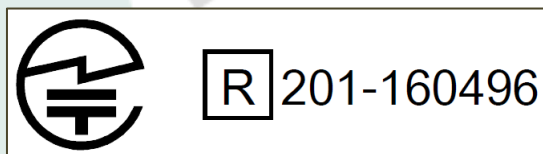

11.10.3. NCC (Taiwan)

請依下列標籤式樣自製標籤，標貼或印鑄於器材本體明顯處，始得販賣或公開陳列。

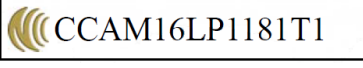
Series	標籤樣式
MDBT42Q Series	
MDBT42Q-P Series	

以 MDBT42Q 為例，平台廠商必須於平台上標示字樣「本產品內含射頻模組：ID 編號 CCAM16LP1180T2」。

「平台」定義如下：若器材組裝本案模組，消費者仍能正常使用該器材主要功能，該器材得視為平台。若器材不組裝本案模組，消費者不能正常使用該器材主要功能，該器材不能視為平台。該類不同廠牌型號器材組裝本案審驗模組後，須分別申請型式認證。

11.10.4. IC (Canada)

The IC statement should be included in the user manual when there is no enough space on label. Otherwise, it should be included on the label.

“This device complies with Industry Canada license-exempt RSS Standard(s). Operation is subject to the following two conditions. (1) This device may not cause harmful interference. (2) This device must accept any interference received, including interference that may cause undesired operation.

Le présent appareil est conforme aux CNR d'Industrie Canada applicables aux appareils radio exempts de licence. L'exploitation est autorisée aux deux conditions suivantes: (1) l'appareil ne doit pas produire de brouillage, et (2) l'utilisateur de l'appareil doit accepter tout brouillage radioélectrique subi, même si le brouillage est susceptible d'en compromettre le fonctionnement.”

The final end product must be labeled in a visible area with the following: “Contain IC ID: 8017A-MDBT42Q”.

12. Notes and Cautions

Module is not designed to last for a lifetime. Like general products, it is expected to be worn out after continuous usage through the years. To assure that product will perform better and last longer, please make sure you:

- Follow the guidelines of this document while designing circuit/end-product. Any discrepancy of core Bluetooth technology and technical specification of IC should refer to definition of Bluetooth Organization and Nordic Semiconductor as final reference.
- Do not supply voltage that is not within range of specification.
- Eliminate static electricity at any cost when working with the module as it may cause damage. It is highly recommended adding anti-ESD components to circuit design to prevent damage from real-life ESD events. Anti-ESD methods can be also applied in mechanical design.
- Do not expose modules under direct sunlight for long duration. Modules should be kept away from humid and salty air conditions, and any corrosive gasses or substances. Store it within -40°C to $+125^{\circ}\text{C}$ before and after installation.
- Avoid any physical shock, intense stress to the module or its surface.
- Do not wash the module. No-Clean Paste is used in production. Washing it will oxidize the metal shield and have chemistry reaction with No-Clean Paste. Functions of the module are not guaranteed if it has been washed.

The module is not suitable for life support device or system and not allowed to be used in destructive device or systems in any direct or indirect ways. The customer agrees to indemnify Raytac for any losses when applying modules in applications such as the ones described above.

13. Basic Facts for nRF52 Chip

Below chart shows basic spec for Nordic nRF52 family, which is helpful to understand the differences between each SoC. Any discrepancy shall refer to Nordic’s technical document as final reference.

See [Full List of Raytac’s BLE Modules](#) for complete model no. of each item.

Nordic Solution	nRF52840	nRF52833	nRF52820	nRF52832	nRF52810	nRF52811	nRF52805
RAYTAC Model No. (MDBTXX)	50Q series	50Q series 50 series	50 series	42Q series 42 series 42V series	42Q series	42Q Series	42T series 42TV series
Bluetooth Direction Finding		V	V			V	
Bluetooth 5 Long Range (125kbps)	V	V	V			V	
Bluetooth 5 High Speed	V	V	V	V	V	V	V
Bluetooth 5 Ad. Extention (x8)	V	V	V	V	V	V	V
Flash (kBytes)	1024	512	256	512	192	192	192
RAM (kBytes)	256	128	32	64	24	24	24
ANT Plus	V	V	V	V	V	V	
IEEE 802.15.4	V	V	V			V	
ARM® TrustZone® Cryptocell	V						
USB	V	V	V				
QSPI	V						
NFC	V	V		V			
I2S	V	V		V			
SPI, TWI, UART, PWM	V	V	V	V	V	V	without PWM
PDM	V	V		V	V	V	
ADC, Comparators	V	V	without ADC	V	V	V	without comparators
Supply Range (V)	1.7 to 5.5	1.7 to 5.5	1.7 to 5.5	1.7 to 3.6	1.7 to 3.6	1.7 to 3.6	1.7 to 3.6

14. Useful Links

- **Nordic Infocenter:** <https://infocenter.nordicsemi.com/index.jsp>
All the necessary technical files and software development kits of Nordic's chip are on this website.
- **Nordic Developer Zone:** <https://devzone.nordicsemi.com/questions/>
A highly recommended website for firmware developer. Interact with other developers and Nordic's employees will help with your questions. The site also includes tutorials in detail to help you get started.
- **Official Page of nRF52810 :** <https://www.nordicsemi.com/eng/Products/nRF52810>
A brief introduction to nRF52810 and download links for Nordic's developing software and SoftDevices.

History of Firmware Revision

FW Ver.	Compatible HW Build	Release Date	Description of Revision	Note
1.0		2018/04/24	1 st release.	99-52810-02A
1.1		2018/06/01	<ol style="list-style-type: none"> 1. UI changes: <ul style="list-style-type: none"> - Add battery service. - Add "AT?ADCVALUE" to get ADC value in BLE connecting status. - Add "AT+DISCONNECT" to terminate the connection. - If response enabled, "AT+" will response info. - Set forever advertising (no timeout) as default. 2. Add new AT commands: <ul style="list-style-type: none"> - AT+RESPONSEDIS - AT+RESPONSEEN (Default) - AT?RESPONSE - AT?ALLPARAMETERS 	99-52810-02B
1.2		2018/06/27	Fixed bugs of battery service.	99-52810-02C
1.3		2018/10/22	<ol style="list-style-type: none"> 1. Improved power consumption. 2. UI Changes: <ul style="list-style-type: none"> - Add "AT+SLEEP" to sleep in connected state 3. Add new AT commands <ul style="list-style-type: none"> - AT+CONNECTINTERVALMODE2 - AT+CONNECTINTERVALTIMEttttttt 	99-52810-02D

FW Ver.	Compatible HW Build	Release Date	Description of Revision	Note
1.3		2018/10/22	(continued) <ul style="list-style-type: none"> - AT?CONNECTINTERVALTIME - AT+SETGPIOnnHIGH - AT+SETGPIOnnLOW - AT+SETGPIOnnOFF 4. Modify detection for ADC value. 5. Add function of setting MAC address by the user.	99-52810-02D
1.4		2019/04/09	1. Fixed issues of reading MAC address. 2. Added an update process on DLE after connection.	99-52810-02E

Full List of Raytac's BLE Modules

● MDBT40 Series

Series	Nordic Solution	Raytac No.	IC Ver.	Antenna	RAM	Flash Memory
MDBT40	nRF51822	MDBT40-256V3	3	Chip Antenna	16 kb	256 K
		MDBT40-256RV3			32 kb	256 K
MDBT40-P	nRF51822	MDBT40-P256V3	3	PCB Antenna	16 kb	256 K
		MDBT40-P256RV3			32 kb	256 K

● MDBT42Q Series (QFN Package IC)

Series	Nordic Solution	Raytac No.	IC Ver.	Antenna	RAM	Flash Memory
MDBT42Q	nRF52832	MDBT42Q-512KV2	2	Chip Antenna	64 kb	512 K
	nRF52810	MDBT42Q-192KV2	2		24 kb	192 K
	nRF52811	MDBT42Q-192KL	1			
MDBT42Q-P	nRF52832	MDBT42Q-P512KV2	2	PCB Antenna	64 kb	512 K
	nRF52810	MDBT42Q-P192KV2	2		24 kb	192 K
	nRF52811	MDBT42Q-P192KL	1			
MDBT42Q-U	nRF52832	MDBT42Q-U512KV2	2	u.FL Connector	64 kb	512 K

● MDBT42 Series (WLCSP Package IC)

Series	Nordic Solution	Raytac No.	IC Ver.	Antenna	RAM	Flash Memory
MDBT42	nRF52832	MDBT42-512KV2	2	Chip Antenna	64 kb	512 K
MDBT42-P		MDBT42-P512KV2		PCB Antenna		

● MDBT42V Series (WLCSP Package IC)

Series	Nordic Solution	Raytac No.	IC Ver.	Antenna	RAM	Flash Memory
MDBT42V	nRF52832	MDBT42V-512KV2	2	Chip Antenna	64 kb	512 K
MDBT42V-P		MDBT42V-P512KV2		PCB Antenna		

● MDBT42T Series (WLCSP Package IC)

Series	Nordic Solution	Raytac No.	IC Ver.	Antenna	RAM	Flash Memory
MDBT42T	nRF52805	MDBT42T-192K	1	Chip Antenna	24 kb	192 K
MDBT42T-P		MDBT42T-P192K		PCB Antenna		

● MDBT42TV Series (WLCSP Package IC)

Series	Nordic Solution	Raytac No.	IC Ver.	Antenna	RAM	Flash Memory
MDBT42TV	nRF52805	MDBT42TV-192K	1	Chip Antenna	24 kb	192 K
MDBT42TV-P		MDBT42TV-P192K		PCB Antenna		

● MDBT50Q Series (aQFN Package IC)

Series	Nordic Solution	Raytac No.	IC Ver.	Antenna	RAM	Flash Memory
MDBT50Q	nRF52840	MDBT50Q-1MV2	2	Chip Antenna	256 kb	1 MB
	nRF52833	MDBT50Q-512K	1		128 kb	512 kb
MDBT50Q-P	nRF52840	MDBT50Q-P1MV2	2	PCB Antenna	256 kb	1 MB
	nRF52833	MDBT50Q-P512K	1		128 kb	512 kb
MDBT50Q-U	nRF52840	MDBT50Q-U1MV2	2	u.FL Connector	256 kb	1 MB
	nRF52833	MDBT50Q-U512K	1		128 kb	512 kb
Dongle	nRF52840	MDBT50Q-RX	1, 2	PCB Antenna	256 kb	1 MB

● MDBT50 Series (QFN Package IC)

Series	Nordic Solution	Raytac No.	IC Ver.	Antenna	RAM	Flash Memory
MDBT50	nRF52820	MDBT50-256R	1	Chip Antenna	32 kb	256 kb
	nRF52833	MDBT50-512K	1		128 kb	512 kb
MDBT50-P	nRF52820	MDBT50-P256R	1	PCB Antenna	32 kb	256 kb
	nRF52833	MDBT50-P512K	1		128 kb	512 kb

● MDBT53 Series (WLCSP Package IC)

Series	Nordic Solution	Raytac No.	IC Ver.	Antenna	RAM	Flash Memory
MDBT53	nRF5340	MDBT53-1M	1	Chip Antenna	512 kb	1 MB
MDBT53-P	nRF5340	MDBT53-P1M	1	PCB Antenna	512 kb	1 MB
MDBT53-U	nRF5340	MDBT53-U1M	1	u.FL Connector	512 kb	1 MB

● MDBT53V Series (WLCSP Package IC)

Series	Nordic Solution	Raytac No.	IC Ver.	Antenna	RAM	Flash Memory
MDBT53V	nRF5340	MDBT53V-1M	1	Chip Antenna	512 kb	1 MB
MDBT53V-P	nRF5340	MDBT53V-P1M	1	PCB Antenna	512 kb	1 MB

Release Note

- 2018/05/11 Version A: 1st release
- 2018/06/08 Version B:
 - (1) See [History of Firmware Revision](#) for FW version 1.1.
- 2018/06/27 Version C:
 - (1) See [History of Firmware Revision](#) for FW version 1.2.
- 2018/08/13 Version D:
 - (1) Added Chapter 5: Product Dimension
 - (2) Updated tray info in Chapter 7, “no washing” note in Chapter 11.
- 2018/10/22 Version E:
 - (1) Updated Chapter 7
 - (2) See [History of Firmware Revision](#) for FW version 1.3.
- 2020/04/13 Version F:
 - (1) See [History of Firmware Revision](#) for FW revision 1.4.
 - (2) Updated the tray info in section 7.2.
 - (3) Updated technical spec based on nRF52810 Specification V1.3.
 - (4) Added section 9: Antenna.
 - (5) Added MDBT50-256R & MDBT50-P256R (nRF52820 module) in the list of Raytac BLE module.
- 2020/06/11 Version G:
 - (1) Refined description in section 3.
 - (2) Added tolerance of size info in section 5.
 - (3) Updated CE EN300 328 v.2.2.2 and information of 2Mbps in section 11.
 - (4) Added nRF52820 in section 13.

- 2020/12/31 Version H
 - (1) Refined description in section 1 of Chapter 3: How to Control via External MCU.
 - (2) Updated information of T&R in Chapter 7: Shipment Packaging Information.
 - (3) Added BT 5.2 SIG approval in Chapter 11: Certification.
 - (4) Updated table in Chapter 13: Basic Facts for nRF52 Family.
 - (5) Updated Full List of Raytac's BLE Modules.

- 2021/07/07 Version I
 - (1) Adding information of current consumption in sleep mode in Chapter 4: Current Test.
 - (2) Updated graphs in section 2 of Chapter 5: Product Dimension.
 - (3) Updated information of T&R in Chapter 7: Shipment Packaging Information.
 - (4) Refined description of default in Chapter 10: Reference Circuit.
 - (5) Updated SRRC certificate in Chapter 11: Certification.

- 2022/07/01 Version J
 - (1) Updated Chapter 7: 7.2.1 Tray Packaging with 7.2.2 Tape & Reel Packaging info.
 - (2) Updated Chapter 5: 5.3 RF Layout Suggestion (aka Keep-Out Area).
 - (3) Updated List of Raytac's Model no.
 - (4) Updated Chapter 8: Specification corresponding to Nordic's new nRF52810 Product Specification V1.4.

- 2022/08/19 Version K
 - (1) Added item 4 info in Chapter 3.1: How to Send AT Commands info.
 - (2) Added item 3 info in Use Hardware Method in Chapter 3.3:
 - (3) Added item 3 info in Use Software Method in Chapter 3.3: