

## MAXM15467 2.5V Output Evaluation Kit

## Evaluates: MAXM15467 2.5V Output-Voltage Application

### General Description

The MAXM15467 2.5V output evaluation kit (EV kit) provides a proven design to evaluate the MAXM15467 high-voltage, high-efficiency, synchronous step-down DC-DC module. The EV kit is programmed to deliver 2.5V output for loads up to 300mA. The EV kit features an adjustable input undervoltage lockout, selectable mode, and open-drain  $\overline{\text{RESET}}$  signal. The MAXM15467 data sheet provides a complete description of the module that should be read in conjunction with this EV kit data sheet prior to modifying the demo circuit. For full module features, benefits and parameters, refer to the MAXM15467 data sheet.

### Features

- Highly Integrated Solution
- Wide 4.5V to 36V Input Range
- Programmed 2.5V Output, Delivers Up To 300mA Output Current
- High 76.41% Efficiency ( $V_{\text{IN}} = 24\text{V}$ ,  $V_{\text{OUT}} = 2.5\text{V}$  at 150mA)
- 550kHz Switching Frequency
- ENABLE/UVLO Input, Resistor-Programmable UVLO Threshold
- PFM Feature for Better Light-Load Efficiency
- Fixed Internal 3.75ms Soft-Start Time
- $\overline{\text{RESET}}$  Output, with Pullup Resistor to  $V_{\text{CC}}$
- Overcurrent and Overtemperature Protection (OCP and OTP)
- Low-Profile, Surface-Mount Components
- Proven PCB Layout
- Fully Assembled and Tested
- Complies with CISPR22(EN55022) Class B Conducted and Radiated Emissions

### Quick Start

#### Recommended Equipment

- One 4.5V to 42V DC, 300mA power supply
- 0.5W resistive load with 300mA sink capacity
- Four digital multimeters (DMM)
- MAXM15467EVKIT#

#### Equipment Setup and Test Procedure

The EV kit is fully assembled and tested. Follow the steps below to verify the board operation.

**Caution: Do not turn on power supply until all connections are completed.**

- 1) Set the power supply at a voltage between 4.5V and 36V. Then, disable the power supply.
- 2) Connect the positive terminal of the power supply to the VIN PCB pad and the negative terminal to the nearest GND PCB pad. Connect the positive terminal of the 300mA load to the VOUT PCB pad and the negative terminal to the nearest GND PCB pad.
- 3) Connect the DVM (DMM in voltage-measurement mode) across the VOUT PCB pad and the nearest GND PCB pad.
- 4) Verify that shunt is not installed on jumper J1 (see [Table 1](#) for details).
- 5) Turn on the DC power supply.
- 6) Enable the load.
- 7) Verify that the DVM displays 2.5V.

**Ordering Information appears at end of data sheet.**

### Detailed Description

The MAXM15467 EV kit is designed to demonstrate salient features of MAXM15467 power module. The EV kit includes an EN/UVLO PCB pad, and jumper J1, to enable the output at a desired input voltage. Jumper J2 allows selection of either PWM or PFM mode of operation based on light-load performance requirements. An additional RESET pad is available for monitoring if the converter output voltage is in regulation.

### Output Capacitor Selection

X7R ceramic output capacitors are preferred due to their stability over temperature in industrial applications. The required output capacitor (C5) for 2.5V output is selected from Table 1 of the [MAXM15467](#) data sheet as 10µF/16V.

### Adjusting Output Voltage

The MAXM15467 supports an adjustable output-voltage range, from 0.9V to 6.3V, using a feedback resistive divider from V<sub>OUT</sub> to FB. Output voltage can be programmed using the values given in Table 1 of the [MAXM15467](#) data sheet. For 2.5V output, R3 is chosen as 133kΩ, and R4 is chosen as 75kΩ.

### Enable/Undervoltage-Lockout (EN/UVLO) Programming

The MAXM15467 offers an adjustable input undervoltage-lockout feature. In this EV kit, for normal operation, leave jumper J1 open. When J1 is left open, the MAXM15467 is enabled when the input voltage rises above 4.5V. To disable MAXM15467, install a jumper across pins 2-3 on J1. See [Table 1](#) for J1 settings. A potential divider formed by R1 and R2 sets the input voltage (V<sub>INU</sub>) at which the module is enabled. The value of resistor R1 is chosen to be 2.2MΩ, and R2 is calculated using the following equation:

$$R_2 = \frac{R_1 \times 1.215}{(V_{INU} - 1.215)}$$

where R1 and R2 are in kΩ,

For MAXM15467 to turn on at 4.5V input, the Resistor R2 is calculated to be 825kΩ.

### Input Capacitor Selection

The input capacitor serves to reduce the current peaks drawn from the input power supply and reduces switching frequency ripple at the input. The input capacitance must be greater than or equal to the value given in Table 1 of [MAXM15467](#) data sheet. Input capacitor C3 is chosen to be 1µF/50V.

### Electro-Magnetic Interference (EMI)

Compliance to conducted emissions (CE) standards requires an EMI filter at the input of a switching power converter. The EMI filter attenuates high-frequency currents drawn by the switching power converter, and limits the noise injected back into the input power source.

Use of EMI filter components as shown in [Figure 1](#) in conjunction with the schematic results in lower conducted emissions below CISPR22 Class B limits. The MAXM15467 EV kit PCB layout is also designed to limit radiated emissions from switching nodes of the power converter resulting in radiated emissions below CISPR22 Class B limits.

### Hot-Plug-In and Long Input Cables

The MAXM15467 EV kit PCB provides an optional electrolytic capacitor (C2, 4.7µF/50V) to dampen input voltage peaks and oscillations that can arise during hot-plug-in and/or due to long input cables. This capacitor limits the peak voltage at the input of the MAXM15467 power module, when the EV kit is powered directly from a precharged capacitive source or an industrial backplane PCB. Long input cables, between input power source and the EV kit circuit can cause input-voltage oscillations due

**Table 1. UVLO Enable/Disable Configuration (J1)**

POSITION	EN/UVLO PIN	MAXM15467_ OUTPUT
Not Installed*	Connected to the center node of resistor-divider R1 and R2.	Programmed to startup at desired input-voltage level.
1-2	Connected to V <sub>IN</sub>	Enabled if V <sub>IN</sub> is greater than V <sub>IN(MIN)</sub> .
2-3	Connected to GND	Disabled

\*Default position

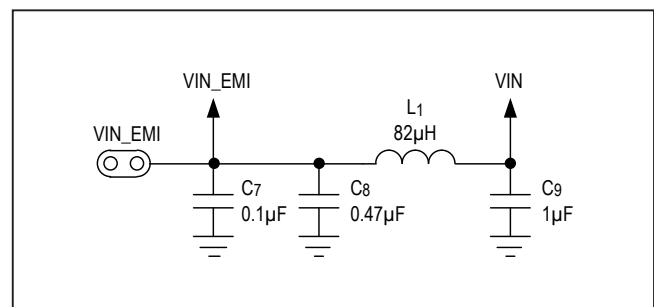

Figure 1. EMI Filter Components

# MAXM15467 2.5V Output Evaluation Kit

# Evaluates: MAXM15467 2.5V Output-Voltage Application

to the inductance of the cables. The equivalent series resistance (ESR) of the electrolytic capacitor helps damp out the oscillations caused by long input cables. Further, capacitor C1 (0.1µF/50V), placed near the input of the board, helps in attenuating high frequency noise.

## Mode of Operation

The MAXM15467 features PFM mode of operation to increase the efficiency at light-load condition. If the MODE pin is left unconnected during powerup, the module operates in PFM mode at light loads. If the MODE pin is connected to GND during power-up, the part operates in constant-frequency PWM mode at all loads. See [Table 2](#) for J2 settings.

## Internal LDO

An internal regulator provides a 5V nominal supply to power the internal functions of the module. The output of the linear regulator ( $V_{CC}$ ) should be bypassed with a 1µF capacitor C4 to GND.

**Table 2. Mode of Operation (J2)**

POSITION	MODE PIN
1-2	Operates in PWM mode.
Not Installed*	Operates in PFM mode at light-load conditions.

\*Default position

## EV Kit Performance Report

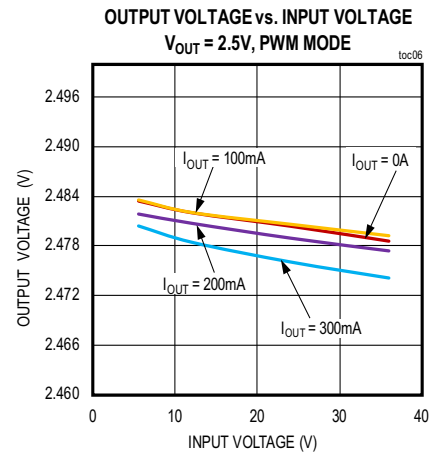
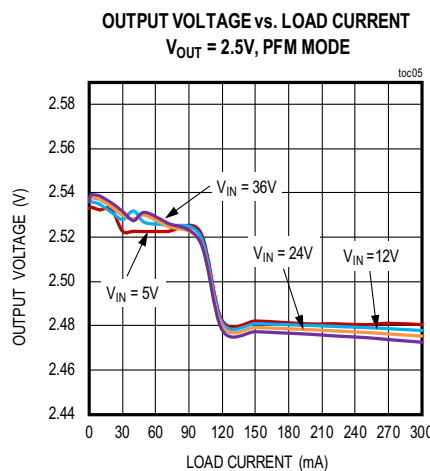
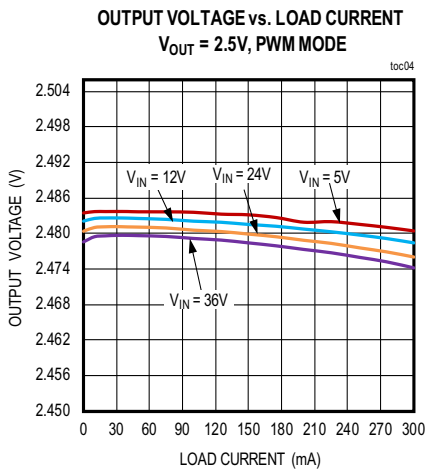
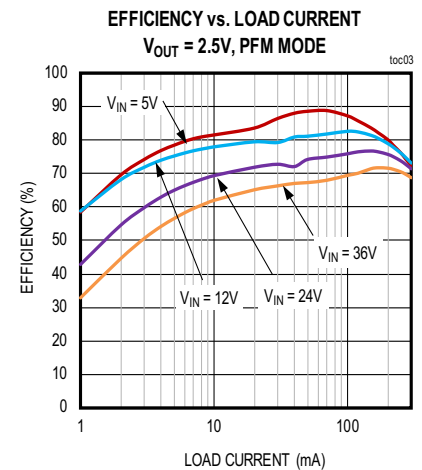
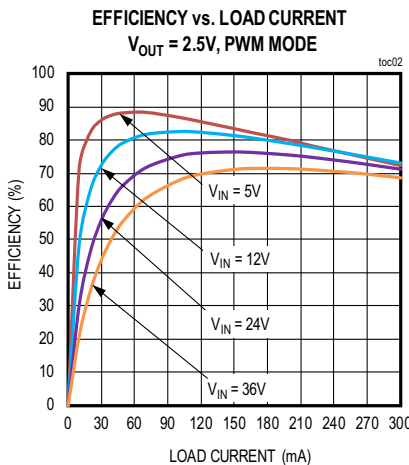
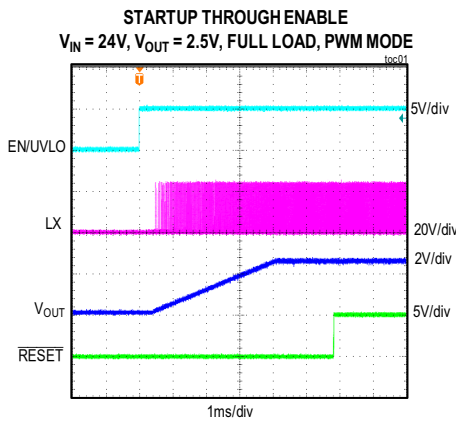

EV Kit Performance Report (continued)

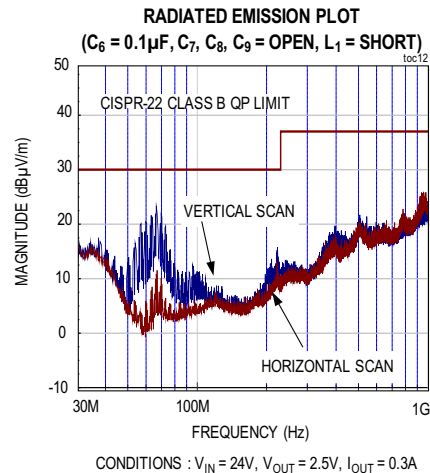
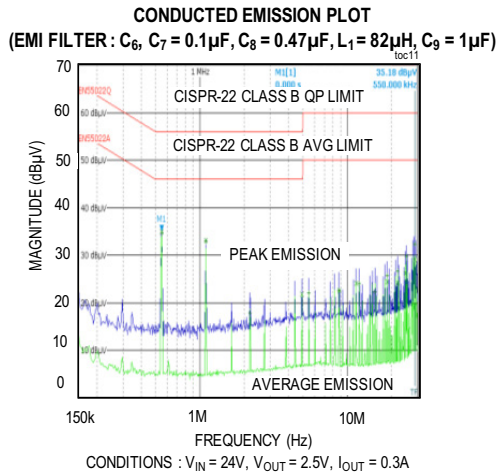
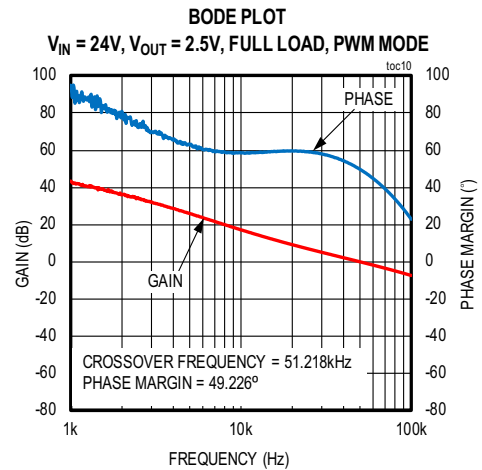
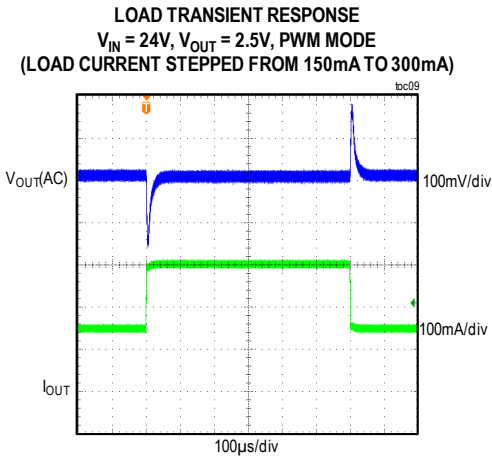
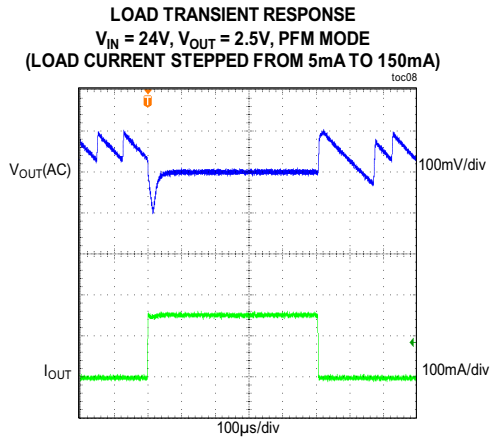
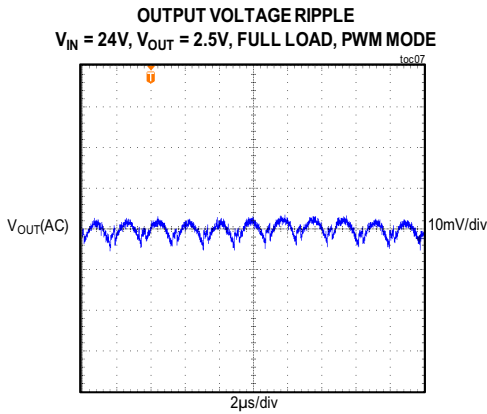

# MAXM15467 2.5V Output Evaluation Kit

# Evaluates: MAXM15467 2.5V Output-Voltage Application

## Ordering Information

PART	TYPE
MAXM15467EVKIT#	EV Kit

#Denotes RoHS compliant.

## Component Suppliers

SUPPLIER	WEBSITE
Murata Americas	www.murata.com
Nichicon	www.nichicon.co.jp
Samsung Electronics.	www.samsungsem.com
Vishay Dale	www.vishay.com
TDK Corp.	www.component.tdk.com
TOKO America, Inc.	www.tokoam.com

**Note:** Indicate that you are using the MAXM15467 when contacting these component suppliers.

## MAXM15467 2.5V EV Kit Bill of Materials

ITEM	QTY	DESIGNATION	DESCRIPTION	MANUFACTURER PART NUMBER - 1	MANUFACTURER PART NUMBER - 2
1	1	C1	0.1µF±10%, 50V, X7R ceramic capacitor (0603)	SAMSUNG ELECTRONICS CL10B104KB8NFNC	
2	1	C2	4.7µF±20%, 50V, Aluminum Capacitor	NICHICON UUD1H4R7MCL	
3	1	C3	1µF±10%, 50V, X7R ceramic capacitor (0805)	MURATA GRM21BR71H105KA12	TDK C2012X7R1H105K085AC
4	1	C4	1µF±10%, 16V, X7R ceramic capacitor (0603)	MURATA GRM188R71C105KA12	TDK C1608X7R1C105K
5	1	C5	10µF±10%, 16V, X7R ceramic capacitor (0805)	MURATA GRM21BZ71C106KE15	SAMSUNG ELECTRONICS CL21B106KOQNNN
6	1	C6	OPEN (OPTIONAL : 0.1µF±10%, 50V, X7R ceramic capacitor (0603))	Murata GRM188R71H104KA93	
7	1	R1	2.2MΩ ±1% resistor (0402)	VISHAY DALE CRCW04022M20FK	
8	1	R2	825kΩ ±1% resistor (0402)	VISHAY DALE CRCW0402825KFK	
9	1	R3	133kΩ ±1% resistor (0402)	VISHAYCRCW0402133KFK	KOA SPEER RK73H1ETTP1333F
10	1	R4	75kΩ ±1% resistor (0402)	VISHAY DALE CRCW040275K0FK	YAGEO PHICOMP RC0402FR-0775KL
11	1	R5	100kΩ ±1% resistor (0402)	VISHAY DALE CRCW0402100KFK	YAGEO PHICOMP RC0402FR-07100KL
12	1	U1	MAXM15467, 10-pin micro-SLIC Power Module	MAXIM MAXM15467AMB+T	
13	1	L1	OPTIONAL : 82µH Shielded Wirewound Inductor(2016)	Murata LQH2MPN820MGRL	
14	1	C7	OPTIONAL : 0.1µF±10%, 0V, X7R ceramic capacitor (0603)	Murata GRM188R71H104KA93	
15	1	C8	OPTIONAL : 0.47µF±10%, 50V, X7R ceramic capacitor (0805)	Murata GRM21BR71H474KA88	
16	1	C9	OPTIONAL : 1µF±10%, 50V, X7R ceramic capacitor (0805)	Murata GRM21BR71H105KA12	

MAXM15467 2.5V EV Kit Schematic

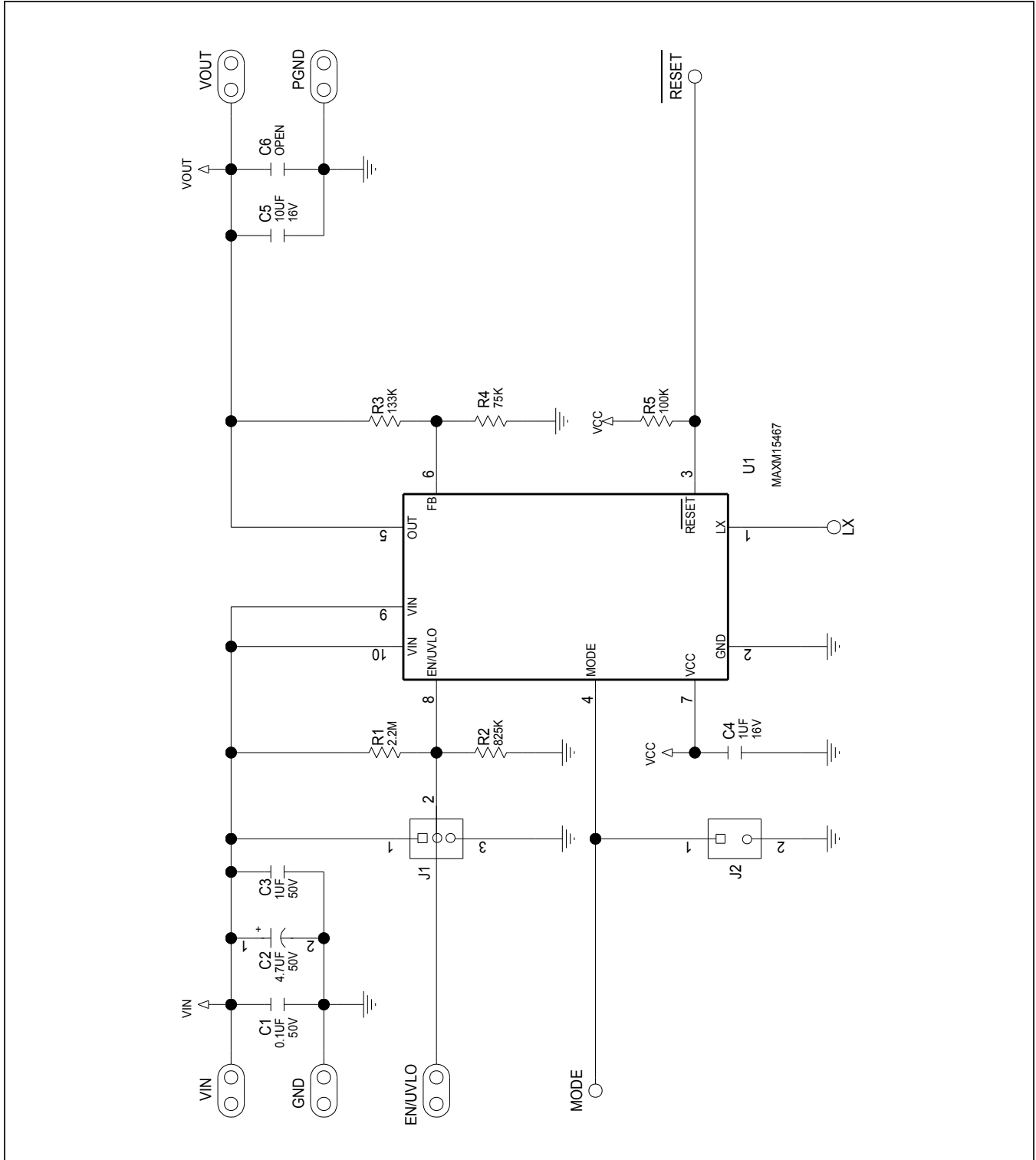

### MAXM15467 2.5V EV Kit PCB Layout Diagrams

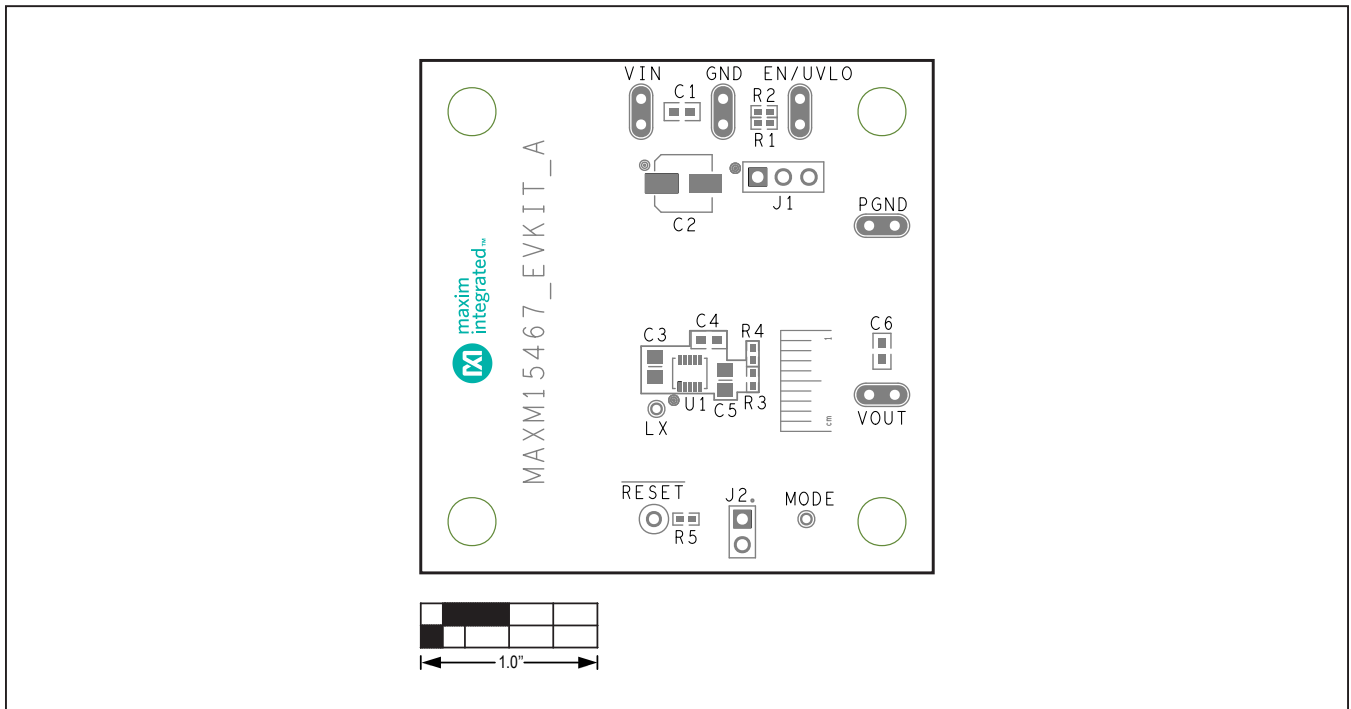

MAXM15467 EV Kit PCB Layout—Silk Top

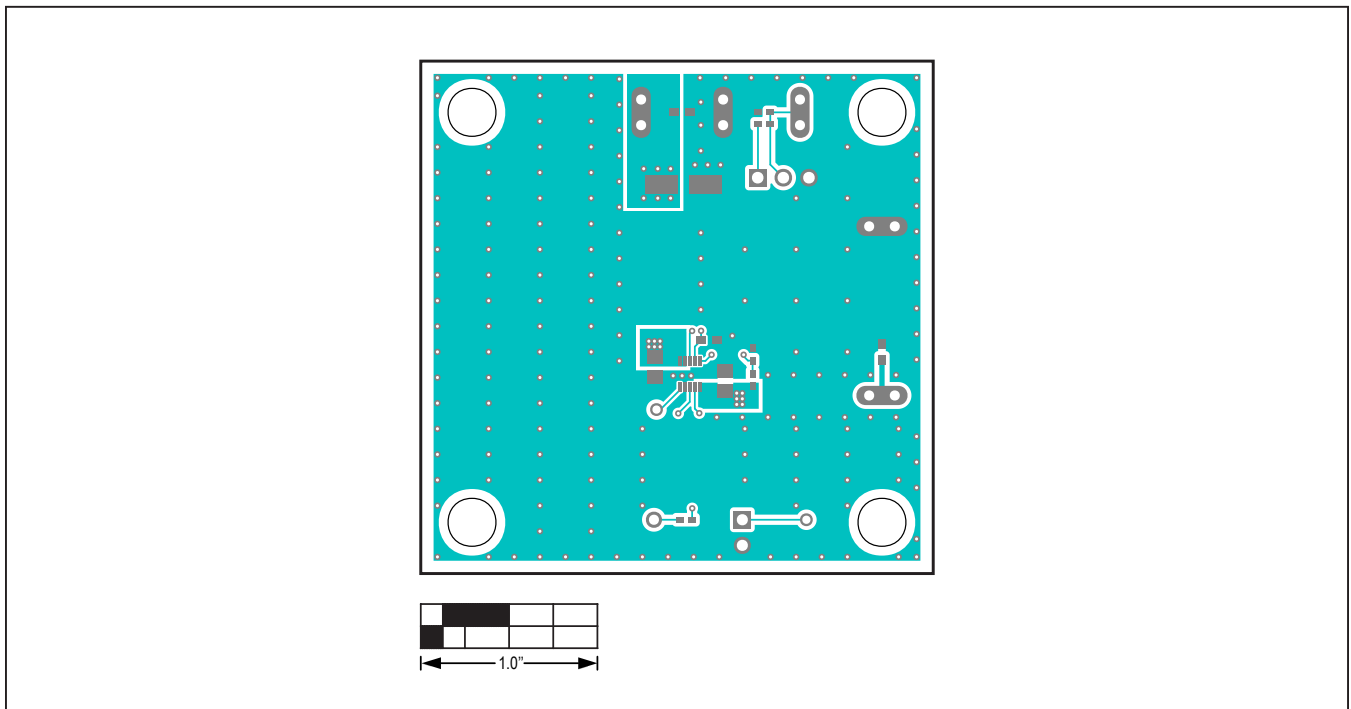

MAXM15467 EV Kit PCB Layout—Top Layer

**MAXM15467 2.5V EV Kit PCB Layout Diagrams (continued)**

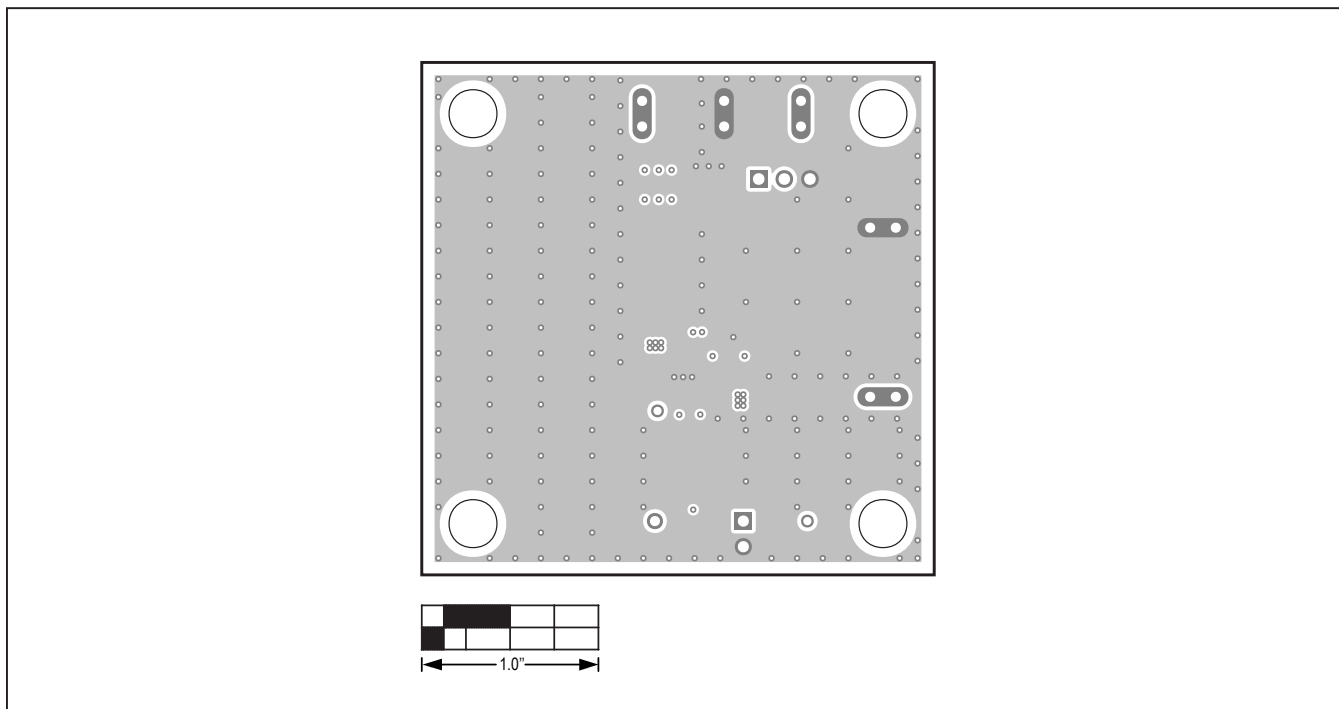

MAXM15467 EV Kit PCB Layout—Layer 2 Ground

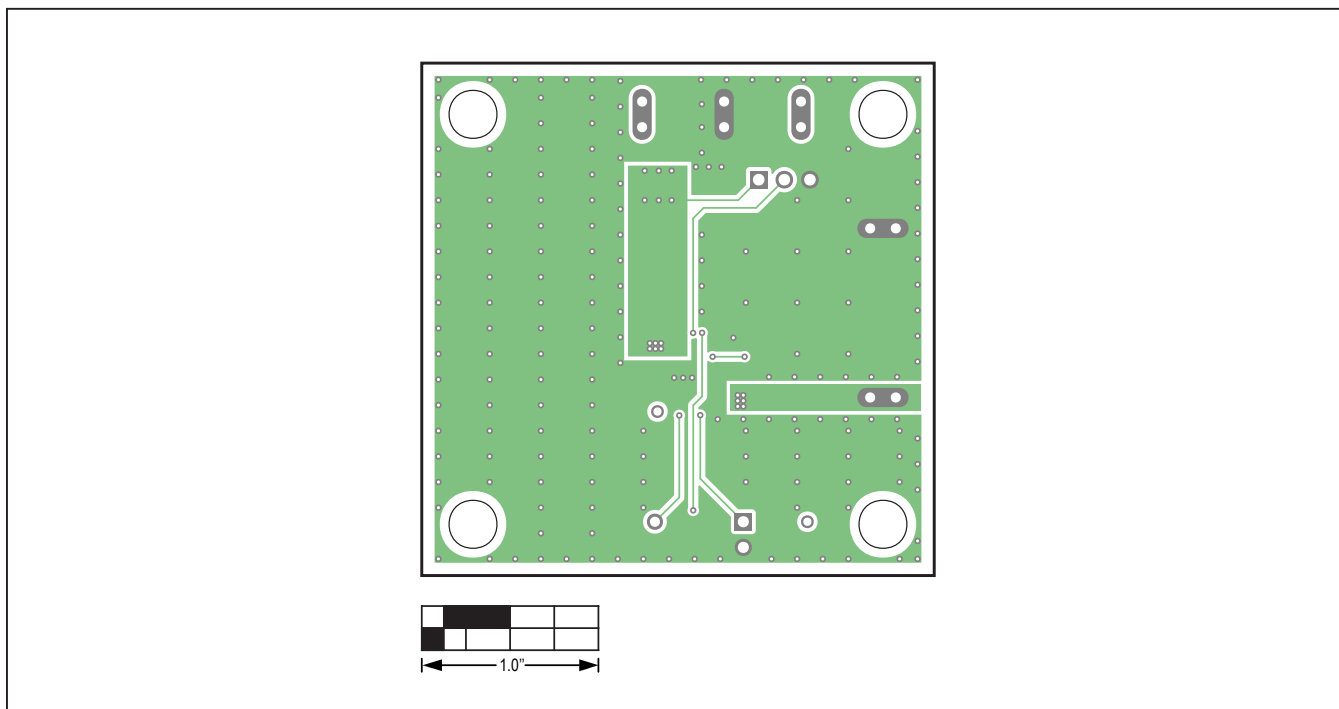

MAXM15467 EV Kit PCB Layout—Layer 3 Power



**MAXM15467 2.5V EV Kit PCB Layout Diagrams (continued)**

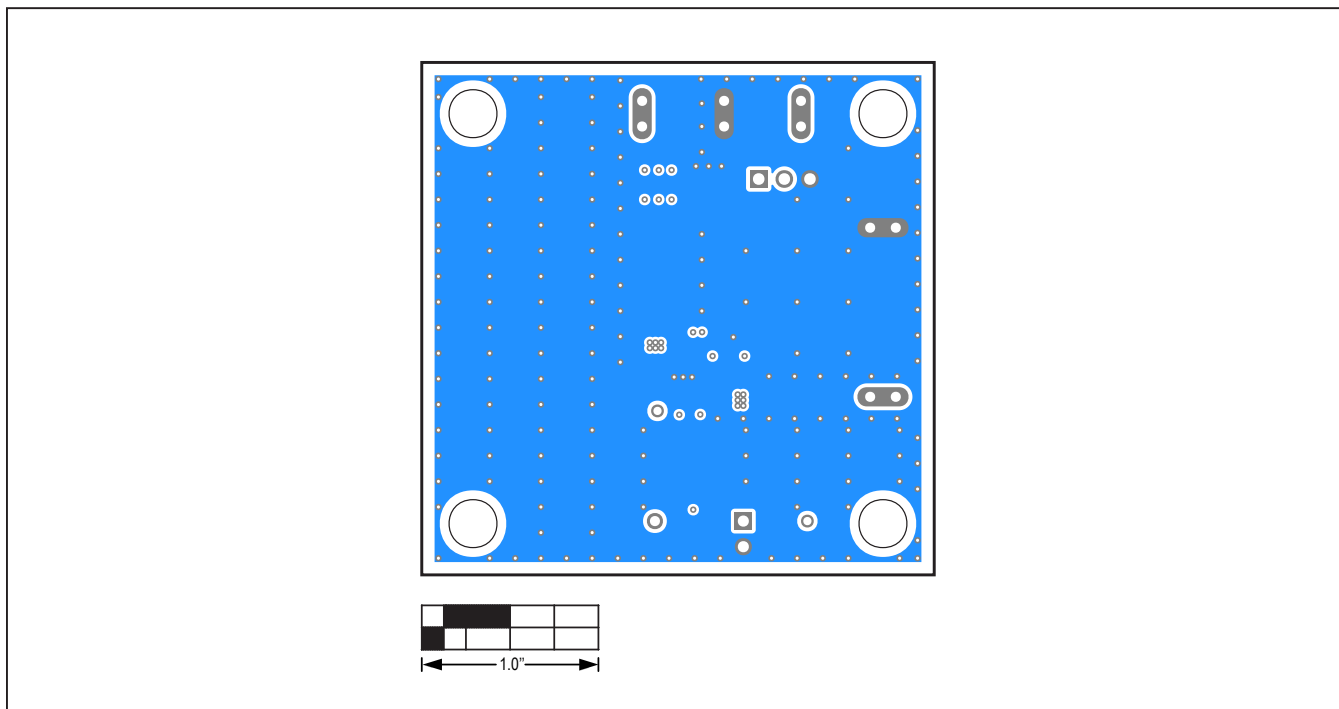

MAXM15467 EV Kit PCB Layout—Bottom Layer

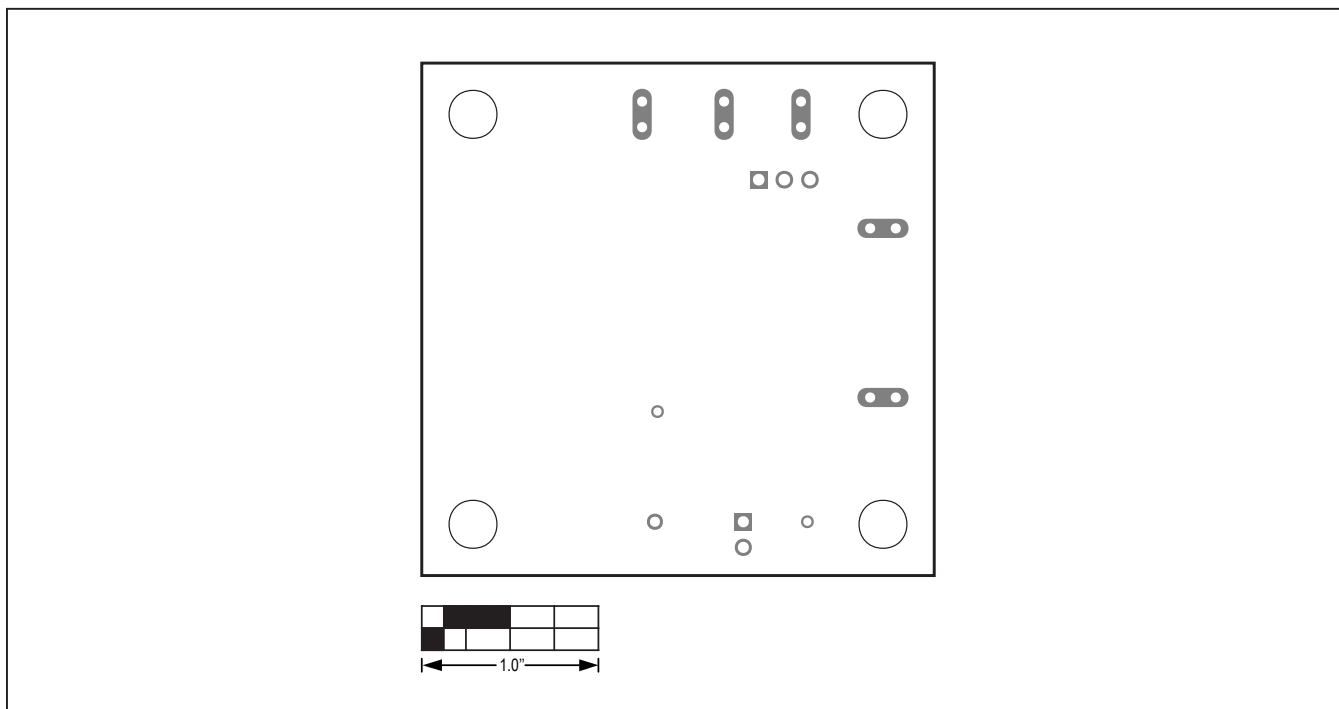

MAXM15467 EV Kit PCB Layout—Silk Bottom

## Revision History

REVISION NUMBER	REVISION DATE	DESCRIPTION	PAGES CHANGED
0	3/19	Initial release	—

For pricing, delivery, and ordering information, please visit Maxim Integrated's online storefront at <https://www.maximintegrated.com/en/storefront/storefront.html>.

*Maxim Integrated cannot assume responsibility for use of any circuitry other than circuitry entirely embodied in a Maxim Integrated product. No circuit patent licenses are implied. Maxim Integrated reserves the right to change the circuitry and specifications without notice at any time.*