

Digital LCD Timer DIN W48×H48mm

■ Features

- Power supply
: 24-240VAC 50/60Hz, 24-240VDC universal
- Easy to switch Up/Down mode
- 10 programmable output modes
and timing ranges (LE3S)
- Selectable function by front digital switches
- Graphic output contact status display (N.O./N.C.)
- BAR graph display of time progressing in 5% increments
- Compact size (length: 74mm)



⚠ Please read "Safety Considerations" in the instruction manual before using.



■ Ordering Information

LE	3	S		
Item	Digit	Size	Output	
			No mark	Time-limit SPDT (1c)
			A	Time-limit DPDT (2c)
			B	Time-limit SPDT (1c), Instantaneous SPDT (1c)
			S	DIN W48×H48mm
			3	999 (3-digit)
			LE	LCD timer (digital switch type)

※8-pin socket (PG-08, PS-08(N)) is sold separately.

■ Specifications

Model		LE3S	LE3SA	LE3SB
Function		Multi time and operation	Multi time range, Power ON Delay operation	
Display method		LCD display (character size: W4×H8mm)		
Power supply		24-240VAC~ 50/60Hz, 24-240VDC≡ universal		
Allowable voltage range		90 to 110% of rated voltage		
Power consumption		Max. 2.5VA (24-240VAC~ 50/60Hz), Max. 1W (24-240VDC≡)	Max. 3.3VA (24-240VAC~ 50/60Hz), Max. 1.5W (24-240VDC≡)	
Return time		Max. 200ms	Max. 100ms	
Min. input signal width	START	Approx. 20ms	—	
	INHIBIT			
	RESET			
Input	START	• No-voltage input Impedance at short-circuit: max. 1kΩ Residual voltage: max. 0.5VDC Impedance at open-circuit: min. 100kΩ	—	
	INHIBIT			
	RESET			
Timing operation		Signal ON Start	Power ON Start	
Control output	Contact type	Time limit SPDT (1c)	Time limit DPDT (2c)	Time limit SPDT (1c), Instantaneous SPDT (1c)
	Contact capacity	250VAC~ 5A, 30VDC≡ 5A resistive load	250VAC~ 3A, 30VDC≡ 3A resistive load	
Relay life cycle	Mechanical	Min. 10,000,000 operations		
	Electrical	Min. 100,000 operations (250VAC 5A resistive load)	Min. 100,000 operations (250VAC 3A resistive load)	
Output mode		10 operation modes	Power ON Delay mode fixed	
Environment	Ambient temp.	-10 to 55°C, storage: -25 to 65°C		
	Ambient humidity	35 to 85%RH		
Accessory		Bracket		



※Environment resistance is rated at no freezing or condensation.

SENSORS
CONTROLLERS
MOTION DEVICES
SOFTWARE

(J) Temperature Controllers
(K) SSRs
(L) Power Controllers
(M) Counters
(N) Timers
(O) Digital Panel Meters
(P) Indicators
(Q) Converters
(R) Digital Display Units
(S) Sensor Controllers
(T) Switching Mode Power Supplies
(U) Recorders
(V) HMIs
(W) Panel PC
(X) Field Network Devices

LE3S Series

Specifications

Model	LE3S	LE3SA	LE3SB
Repeat error	Max. $\pm 0.01\% \pm 0.05$ sec	Max. $\pm 0.01\% \pm 0.05$ sec	
SET error	(for Power ON Start)		
Voltage error	Max. $\pm 0.005\% \pm 0.03$ sec		
Temperature error	(for Signal ON Start)		
Insulation resistance	Over 100M Ω (at 500VDC megger)		
Dielectric strength	2,000VAC 50/60Hz for 1 min		
Noise immunity	± 2 kV the square wave noise (pulse width: 1 μ s) by the noise simulator		
Vibration	Mechanical	0.75mm amplitude at frequency of 10 to 55Hz (for 1 min) in each X, Y, Z direction for 1 hour	
	Malfunction	0.5mm amplitude at frequency of 10 to 55Hz (for 1 min) in each X, Y, Z direction for 10 min	
Shock	Mechanical	300m/s ² (approx. 30G) in each X, Y, Z direction for 3 times	
	Malfunction	100m/s ² (approx. 10G) in each X, Y, Z direction for 3 times	
Approval	  		
Unit weight	Approx. 100g	Approx. 105g	

Connections

LE3S

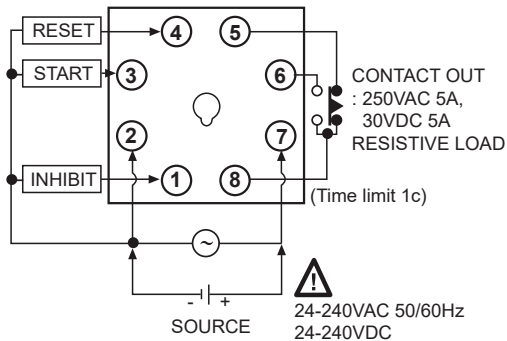

LE3SA

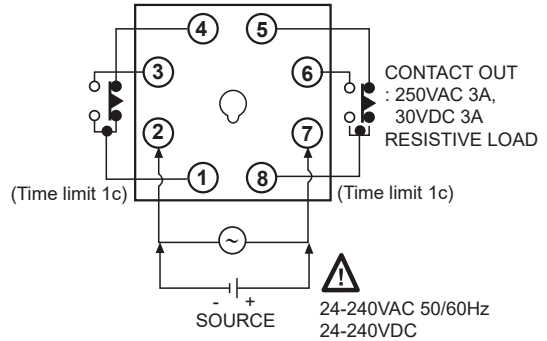

LE3SB

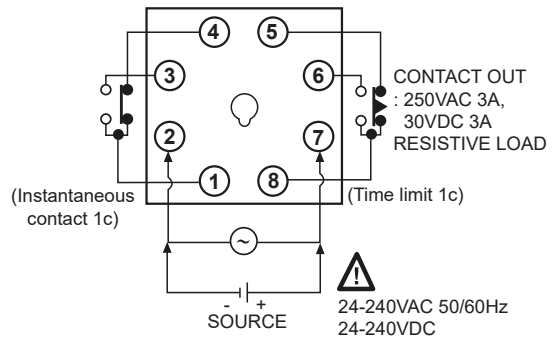

Thumbwheel Switch Setting Type LCD Display Timer

Input Connections (LE3S Only)

Solid-state input

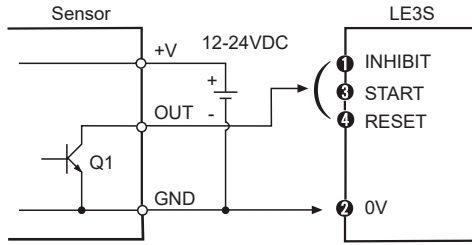

- Q1 is ON: Operating
- Sensor: NPN open collector output

Contact input

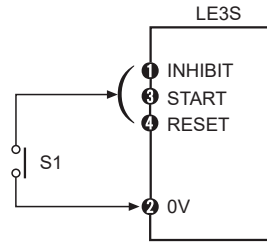

- S1 is ON: Operating
- S1: Micro switch, push button switch, relay

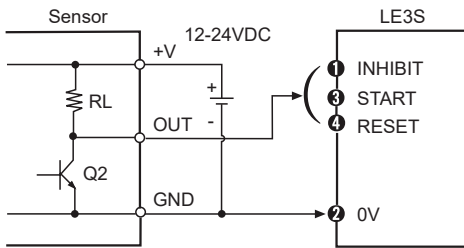

- Q2 is ON: Operating
- Sensor: NPN universal output

Input level

No voltage input	<ul style="list-style-type: none"> • Short-level (transistor is ON) • Residual voltage: Max. 0.5V • Impedance: Max. 1kΩ
	<ul style="list-style-type: none"> • Open-level (transistor is OFF) • Impedance: Min. 100kΩ
Contact input	Please use reliable contacts enough to flow 5VDC 1mA of current.

Dimensions

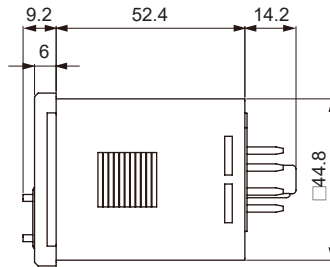
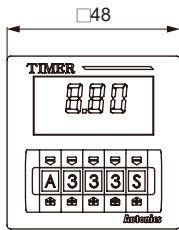

(unit: mm)

Bracket

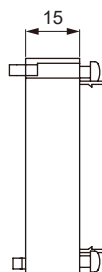
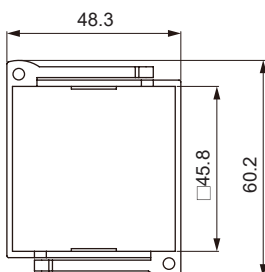
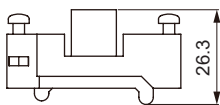

Panel cut-out

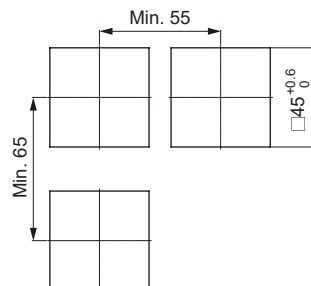

SENSORS

CONTROLLERS

MOTION DEVICES

SOFTWARE

(J)
Temperature
Controllers

(K)
SSRs

(L)
Power
Controllers

(M)
Counters

(N)
Timers

(O)
Digital
Panel Meters

(P)
Indicators

(Q)
Converters

(R)
Digital
Display Units

(S)
Sensor
Controllers

(T)
Switching
Mode Power
Supplies

(U)
Recorders

(V)
HMIs

(W)
Panel PC

(X)
Field Network
Devices

LE3S Series

Unit Description

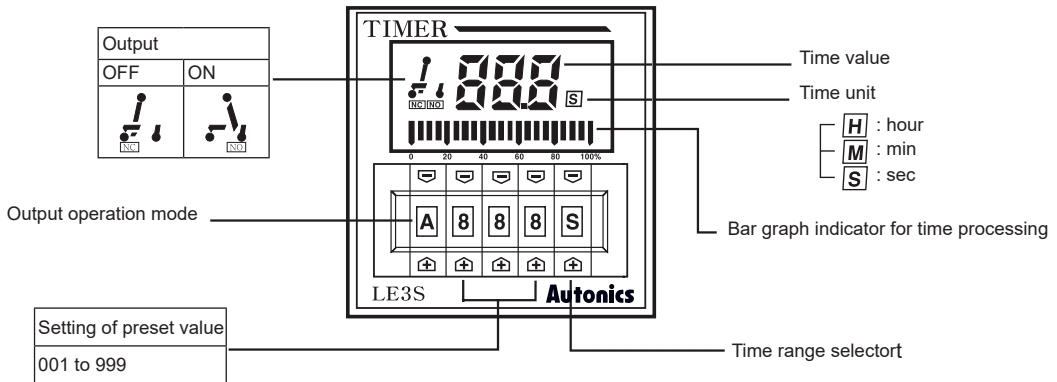

Up/Down Mode

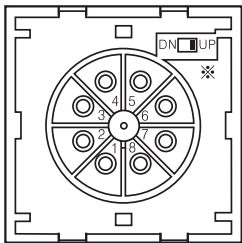

※Output operate as Up or Down mode by Up/Down switch location.

Up	Down
DN <input type="checkbox"/> UP	DN <input type="checkbox"/> UP

⚠ Power must be cut off.

Default specifications

LE3S	LE3SA, LE3SB
Up/Down mode: Up	<ul style="list-style-type: none"> • Up/Down mode: Up • Output mode: A mode (fixed) ※Down mode is option.

Output Operation Mode Selection

Please select operation mode by press the left of \uparrow , \downarrow keys in front panel.

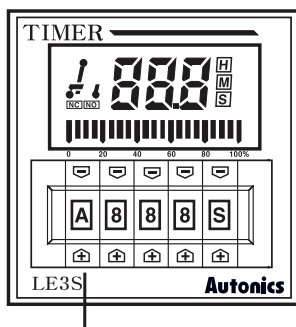

Output operation mode	
A	ON Delay Ⓐ
B	Interval Delay Ⓐ
C	ON Delay Ⓑ
D	Flicker Ⓐ
E	Flicker Ⓑ
F	One-shot Out Flicker
H	OFF Delay
K	ON/OFF Delay
L	Interval Delay Ⓑ
N	Integration Time

※Refer to **LE3SA, LE3SB Output Operation Mode**

- ON Delay Ⓐ of A mode and ON Delay Ⓑ of C mode are different.
- Interval delay Ⓐ of B mode and Interval Delay Ⓑ of L mode are different.
- Flicker Ⓐ of D mode and Flicker Ⓑ of E mode are different.
- ※Output mode Ⓐ is operated as time progresses only when the START signal applied continuously.
- ※Output mode Ⓑ is operated as time progresses even the START signal is applied as One-shot signal. (one-shot input signal should be over 20ms.)

Thumbwheel Switch Setting Type LCD Display Timer

Time Specifications and Time Range

Please select time unit and range by press the right of \leftarrow , \rightarrow keys in front panel.

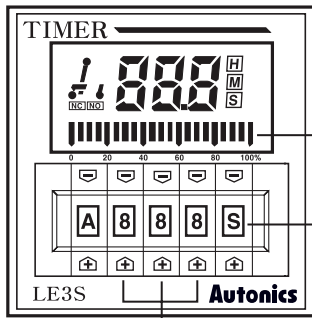

BAR graph: Display % for the time progressing against setting time

Time Range mode	
0.01s	0.01 sec to 9.99 sec
0.1s	0.1 sec to 99.9 sec
s	1 sec to 999 sec
0.1m	0.1 min to 99.9 min
m	1 min to 999 min
0.1h	0.1 hour to 99.9 hour
h	1 hour to 999 hour
10h	10 hour to 9990 hour
S	0 min 01 sec to 9min 59 sec
M	0 hour 01 min to 9 hour 59 min

Time setting digital switch

- Setting of operation time: Please select operation time by press the center of 3 \leftarrow , \rightarrow keys in front panel.
- ⊗ When using this unit with 20.0 sec of operation time.
After selecting **S** as time range, then set digital switches as 20.0 sec
In this case, it is convenient to put a decimal point as below figure.

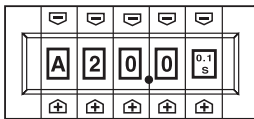

Mark a decimal point.

- Bar graph display: Display the progress rate of time for setting time with bar, it is calculated as below for 1bar.
Setting value (operation time) ÷ 20 (total number of bars) = The time for 1 bar is lighted.

LE3SA, LE3SB Output Operation Mode

t=Setting time, Rt=Reset time (min. 100ms)

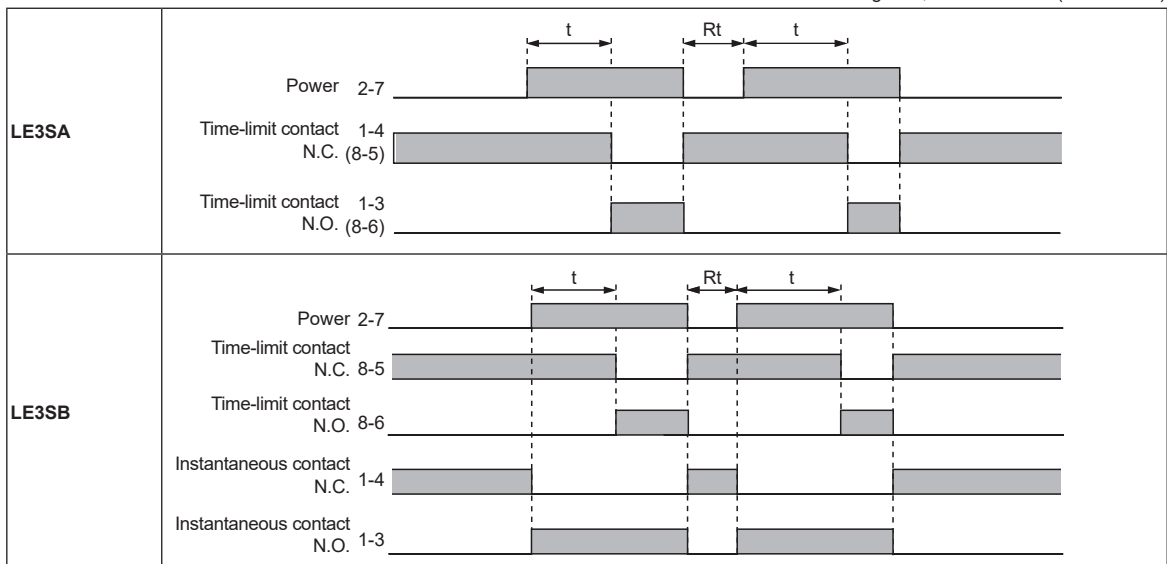

SENSORS
CONTROLLERS
MOTION DEVICES
SOFTWARE
(J) Temperature Controllers
(K) SSRs
(L) Power Controllers
(M) Counters
(N) Timers
(O) Digital Panel Meters
(P) Indicators
(Q) Converters
(R) Digital Display Units
(S) Sensor Controllers
(T) Switching Mode Power Supplies
(U) Recorders
(V) HMIs
(W) Panel PC
(X) Field Network Devices

LE3S Output Operation Mode

T=Setting time, T > Ta

Mode	Time chart
A ON Delay Ⓐ	<p>1. Time progresses when START signal is ON. 2. The output will be ON when the setting value is equal to the display value. (Position ①) 3. When the RESET signal is ON, the display value is returned to the initial state. (Position ③) ※If START signal is OFF when the output is OFF the display value is returned to initial state (Position ④).</p>
B Interval Delay Ⓐ	<p>1. The output turns ON and time progresses when START signal is ON. 2. The output will be ON when the setting value is equal to the display value. (Position ①) 3. When the RESET signal is ON, the display value is returned to the initial state. (Position ③) ※If START signal is OFF when the output is OFF the display value is returned to initial state. (Position ③)</p>
C ON Delay Ⓑ	<p>1. Time proceeds when START signal is ON. 2. The output will be ON when the setting value is equal to the display value. (Position ①) 3. When the RESET signal is ON, the display value is returned to the initial state. ※When start signal is applied repeatedly (Position ①), only the initial signal is recognized. ※Even if the START signal is not applied, time progresses. (Position ②)</p>
D Flicker Ⓐ	<p>1. Time progresses repeatedly when the START signal is ON. 2. The output operates from N.C. to N.O., and from N.O. to N.C. repeatedly. 3. If RESET signal is ON, it is returned to initial state. (Position ①) ※If the START signal is OFF, the display value and output is returned to initial state. (Position ②)</p>
E Flicker Ⓑ	<p>1. Time progresses repeatedly when the START signal is ON. 2. The output operates from N.C. to N.O., and from N.O. to N.C. repeatedly. 3. If RESET signal is ON, it is returned to initial state. (Position ③) ※When START signal is applied repeatedly, only the initial signal is recognized. (Position ①) ※Even if the START signal is not applied, time progresses. (Position ②)</p>

※Initial state: Output is OFF, the display value is "0". (UP mode). The output is OFF and the display value is the setting value (DOWN mode)

※When set the time setting as 000, control output does not come out.

※When using D, E output operation modes, if the time is set too short, the output may not work properly. Please set the time at least over 100ms.

Thumbwheel Switch Setting Type LCD Display Timer

LE3S Output Operation Mode

T=Setting time, $T=T1+T2+T3$, $T > Ta$, $T > Ta+Tb$

Mode	Time chart
F One-shot Out Flicker	<p>1. Time progresses from initial value to the preset value repeatedly and the output operates as one-shot (0.3 sec), when the START signal is ON. (Position ①) 2. If the RESET signal is ON, it is returned to initial state. (Position ③) ※When START signal is applied repeatedly, only the initial signal is recognized. (Position ②)</p>
H OFF Delay	<p>1. The START signal & the output are ON at the same time. The output will return and the display value is held after the setting time. 2. If the RESET signal is ON, the display value is returned to initial state. ※If the START signal is applied continuously, the output will be ON but time is not progressed.</p>
K ON-OFF Delay	<p>1. When the START signal is ON the output is ON the output will be reset and display value is held when setting value is equal to display value. 2. The START signal turns OFF, the output turns ON, the output will be reset and display value is held when setting value is equal to display value. 3. If RESET signal is ON, it is returned to initial state. ※If START signal is applied repeatedly, output keeps ON but be sure that the time will be initialized.</p>
L Interval Delay ③	<p>1. When START signal is ON, the output turns ON and the time progresses at the same time. 2. When the time reaches at the preset value the output will be reset, and the display value is held. 3. If RESET signal is applied, the display value is returned to initial state. ※When START signal is applied repeatedly, only the initial signal is recognized. (Position ①)</p>
N Integration Time	<p>1. When START signal is ON, time progresses. 2. If START signal turns off before the display value reaches the setting value, the time (display value) will be held. 3. If RESET signal is ON, it is returned to initial state.</p>

※Initial state: Output is OFF, the display value is "0". (UP mode). The output is OFF and the display value is the setting value (DOWN mode)

※When set the time setting as 000, control output does not come out.

※When using D, E output operation modes, if the time is set too short, the output may not work properly. Please set the time at least over 100ms.

SENSORS
CONTROLLERS
MOTION DEVICES
SOFTWARE
(J) Temperature Controllers
(K) SSRs
(L) Power Controllers
(M) Counters
(N) Timers
(O) Digital Panel Meters
(P) Indicators
(Q) Converters
(R) Digital Display Units
(S) Sensor Controllers
(T) Switching Mode Power Supplies
(U) Recorders
(V) HMIs
(W) Panel PC
(X) Field Network Devices

LE3S Series

■ Proper Usage

- Follow instructions in 'Proper Usage'. Otherwise, it may cause unexpected accidents.
- When supplying or turning off the power, use a switch or etc. to avoid chattering.
- Install a power switch or circuit breaker in the easily accessible place for supplying or disconnecting the power.
- In order to block peripheral current, use isolation transformer which of secondary part is not grounded as (Figure 1) to supply power to the external input device.

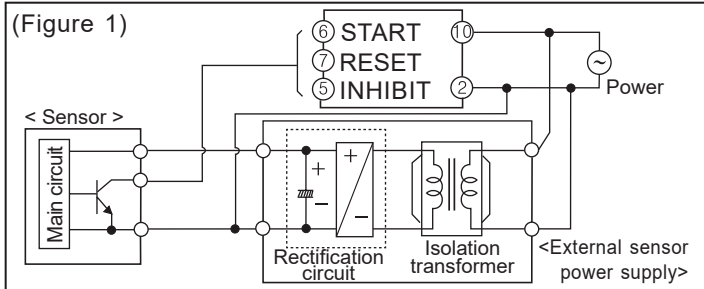

- Do not connect two or more timers with only one input contact or transistor simultaneously.
- Keep away from high voltage lines or power lines to prevent inductive noise.
In case installing power line and input signal line closely, use line filter or varistor at power line and shielded wire at input signal line.
Do not use near the equipment which generates strong magnetic force or high frequency noise.
- Change setting time, time range, operation mode or etc. after turning off the power of the timer.
- This unit may be used in the following environments.
 - ① Indoors (in the environment condition rated in 'Specifications')
 - ② Altitude max. 2,000m
 - ③ Pollution degree 2
 - ④ Installation category II