

ISL28023

Precision Digital Power Monitor with Margining

FN8389  
Rev.6.02  
Jun 13, 2022

The **ISL28023** is a bidirectional high-side and low-side digital current sense and voltage monitor with a serial interface. The device monitors power supply current, voltage and provides the digital results along with calculated power. The ISL28023 provides tight accuracy of 0.05% for both voltage and current monitoring. The auxiliary input provides an additional power monitor function.

The  $V_{CC}$  power can either be externally supplied or internally regulated, which allows the ISL28023 to handle a common-mode input voltage range from 0V to 60V. The wide range permits the device to handle telecom, automotive and industrial applications with minimal external circuitry.

An 8-bit voltage DAC enables a DC/DC converter output voltage margining. Fault indication includes a Bus Voltage window and overcurrent fast fault logic indication.

The ISL28023 serial interface is PMBus compatible and operates down to 1.2V voltage. It draws an average current of just 800µA and is available in the space saving 24 Ld QFN 4mmx4mm package. The part operates across the full industrial temperature range from -40 °C to +125 °C.

**Features**

- Bus voltage sense range ..... 0V to 60V
- Voltage gain error ..... 0.05%
- Current gain error ..... 0.05%
- Internal temperature sensor accuracy ..... +1.0 °C
- High or low (RTN) side sensing
- Bidirectional current sensing
- Auxiliary low voltage channel
- $\Delta\Sigma$  ADC, 16-bit native resolution
- Programmable averaging modes
- Internal 3.3V regulator
- Internal temperature sense
- Overvoltage/undervoltage and current fault monitoring with 500ns detection delay
- 8-bit voltage output DAC
- I<sup>2</sup>C/SMBus/PMBus interface that handles 1.2V supply

**Applications**

- Data processing servers
- DC power distribution
- Telecom equipment
- Portable communication equipment
- DC/DC, AC/DC converters
- Many I<sup>2</sup>C DAC and ADC with alert applications

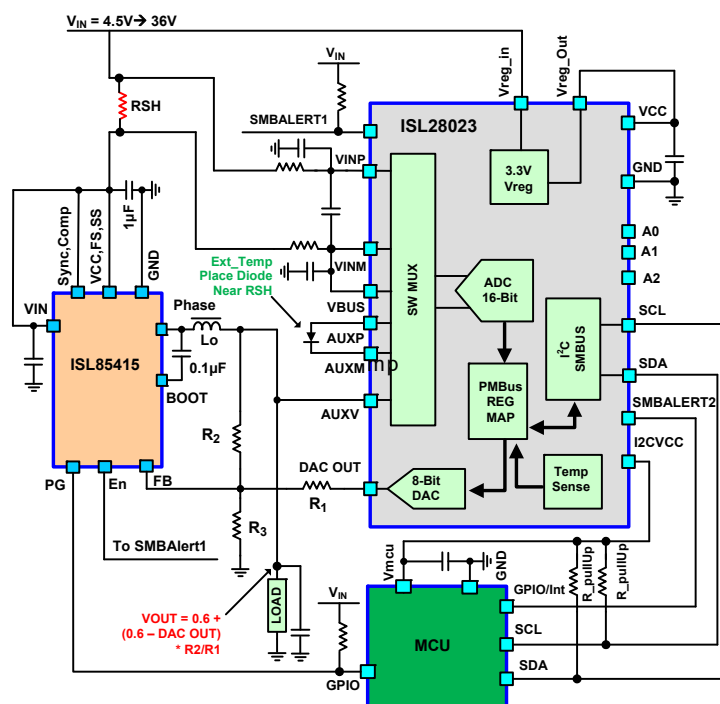

FIGURE 1. APPLICATION DIAGRAM

# Table of Contents

<b>Block Diagram</b> .....	<b>3</b>
<b>Ordering Information</b> .....	<b>3</b>
<b>Pin Configuration</b> .....	<b>4</b>
<b>Pin Descriptions</b> .....	<b>4</b>
<b>Absolute Maximum Ratings</b> .....	<b>6</b>
<b>Thermal Information</b> .....	<b>6</b>
<b>Recommended Operating Conditions</b> .....	<b>6</b>
<b>Electrical Specifications</b> .....	<b>6</b>
<b>Typical Performance Curves</b> .....	<b>12</b>
<b>Overview</b> .....	<b>27</b>
<b>Pin Descriptions</b> .....	<b>27</b>
<b>Communication Protocol</b> .....	<b>30</b>
Packet Error Correction (PEC) .....	30
IC Device Details .....	31
Global IC Controls .....	32
Primary and Auxiliary Channel Controls .....	32
Measurement Registers .....	35
Threshold Detectors .....	36
SMB Alert .....	38
External Clock Control .....	42
Voltage Margin .....	42
<b>SMBus/I<sup>2</sup>C Serial Interface</b> .....	<b>43</b>
Protocol Conventions .....	44
SMBus, PMBus Support .....	44
<b>Device Addressing</b> .....	<b>45</b>
Write Operation .....	46
Read Operation .....	46
Group Command .....	46
Clock Speed .....	47
<b>Signal Integrity</b> .....	<b>47</b>
Fast Transients .....	47
External Clock .....	48
Overranging .....	49
Shunt Resistor Selection .....	49
Lossless Current Sensing (DCR) .....	50
Layout .....	51
A Trace as a Sense Resistor .....	53
<b>Revision History</b> .....	<b>54</b>
<b>Package Outline Drawing</b> .....	<b>55</b>

# Block Diagram

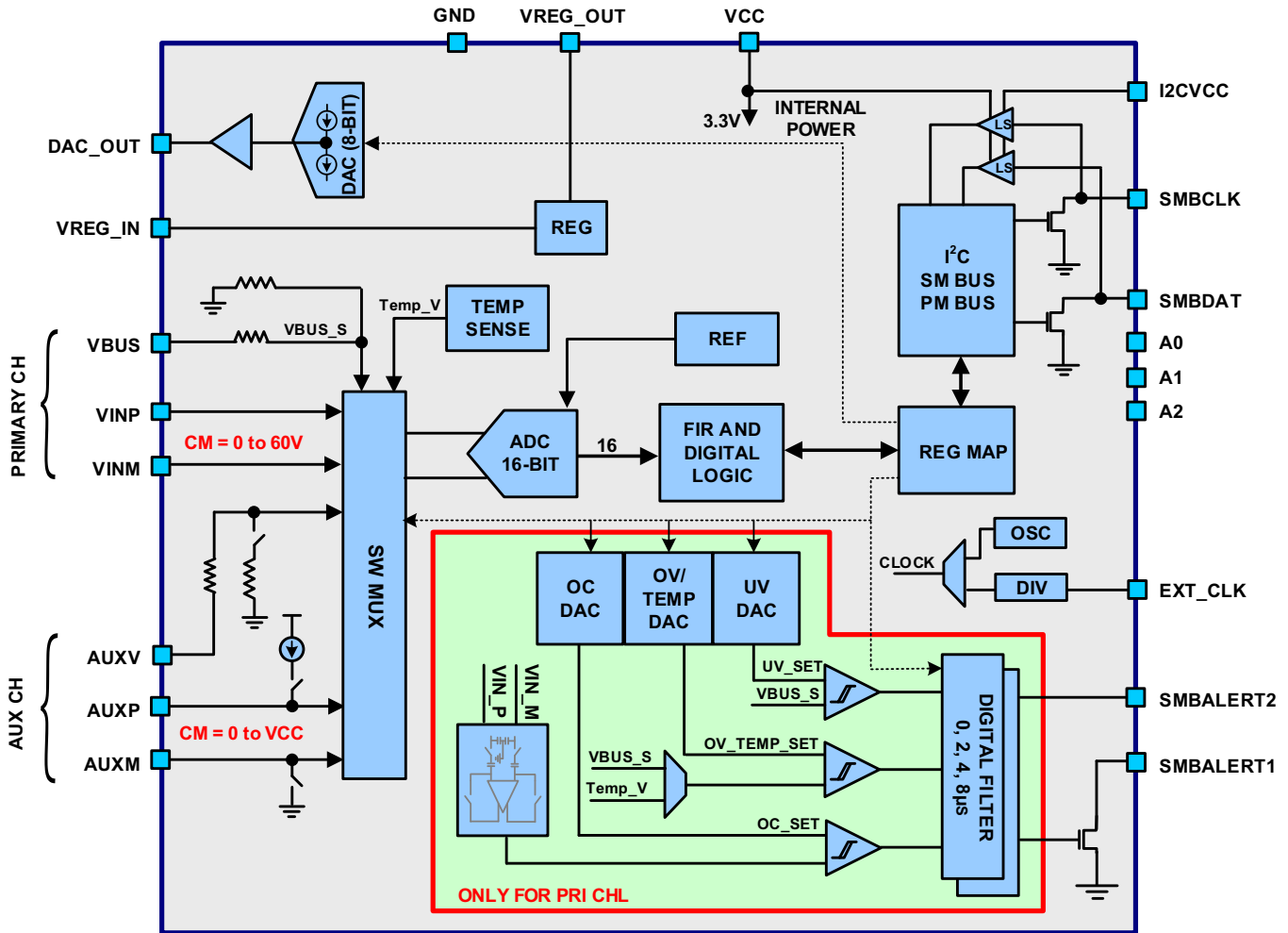

FIGURE 2. BLOCK DIAGRAM

## Ordering Information

PART NUMBER (Notes 2, 3)	PART MARKING	V <sub>BUS</sub> OPTION (V)	PACKAGE DESCRIPTION (RoHS Compliant)	PKG. DWG. #	CARRIER TYPE (Note 1)	TEMP. RANGE
ISL28023FR12Z	280	12	24 Ld QFN	L24.4x4D	Tube	-40 to +125 °C
ISL28023FR12Z-T	23R12Z				Reel, 6k	
ISL28023FR12Z-T7A					Reel, 250	
ISL28023FR60Z	280	60			Tube	
ISL28023FR60Z-T	23R60Z				Reel, 6k	
ISL28023FR60Z-T7A					Reel, 250	
ISL28023EVKIT1Z	Evaluation Kit					

NOTES:

1. See [TB347](#) for details on reel specifications.
2. These Pb-free plastic packaged products employ special Pb-free material sets, molding compounds/die attach materials, and 100% matte tin plate plus anneal (e3 termination finish, which is RoHS compliant and compatible with both SnPb and Pb-free soldering operations). Pb-free products are MSL classified at Pb-free peak reflow temperatures that meet or exceed the Pb-free requirements of IPC/JEDEC J STD-020.
3. For Moisture Sensitivity Level (MSL), see the [ISL28023](#) device page. For more information on MSL, see [TB363](#).

## Pin Configuration

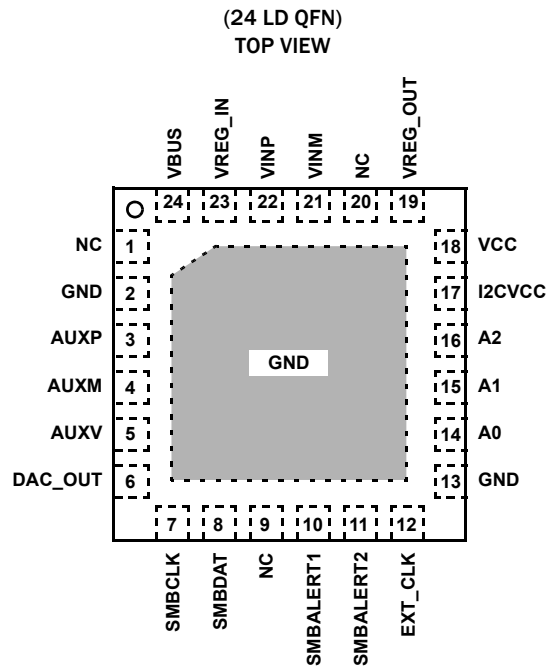

## Pin Descriptions

PIN NUMBER	PIN NAME	TYPE/DIR	PIN DEFINITION
1, 9, 20	NC	N/A	No connect
2	GND	Power	Ground
3	AUXP	Analog Input	Auxiliary port differential input (plus)
4	AUXM	Analog Input	Auxiliary port differential input (minus)
5	AUXV	Analog Input	Auxiliary port single-ended input
6	DAC_OUT	Analog Output	DAC voltage output
7	SMBCLK	Digital Input	SMBus/I <sup>2</sup> C clock input
8	SMBDAT	Digital Input/Output	SMBus/I <sup>2</sup> C data
10	SMBALERT1	Digital Output	SMBus Alert1, open-drain output
11	SMBALERT2	Digital Output	CPU interrupt signal: It is used as CPU interrupt signal.
12	EXT_CLK	Digital Input	External ADC clock input
13	GND	Power	Ground
14	A0	Digital Input	SMBus/I <sup>2</sup> C address input
15	A1	Digital Input	SMBus/I <sup>2</sup> C address input
16	A2	Digital Input	SMBus/I <sup>2</sup> C address input
17	I2CVCC	Power	I <sup>2</sup> C level shifter power supply. This pin should be connected to VCC pin if level shifter is not used.
18	VCC	Power	Chip power supply
19	VREG_OUT	Power	Voltage regulator output, proper decoupling capacitor should be connected to this pin
21	VINM	Analog Input	Current sense minus input
22	VINP	Analog Input	Current sense plus input
23	VREG_IN	Power	Voltage regulator input. This pin should be connected to ground in case voltage regulator is not used.
24	VBUS	Power	VBUS voltage sense

TABLE 1. DPM PORTFOLIO COMPARISON - ISL28022 vs ISL28023 vs ISL28025

DESCRIPTION		BASIC DIGITAL POWER MONITOR	FULL FEATURE DIGITAL POWER MONITOR	DIGITAL POWER MONITOR IN TINY PACKAGE
PART NUMBER		ISL28022	ISL28023	ISL28025
PACKAGE		MSOP10, QFN16	QFN24	WLCSP-16
Temperature Range		-40 °C to +125 °C	-40 °C to +125 °C	-40 °C to +125 °C
0V to 60V Input Range		0V to 60V	Opt 1: 0V to 60V Opt 2: 0V to 16V	Opt 1: 0V to 60V Opt 2: 0V to 16V
ADC		16-bit	16-bit	16-bit
+25 °C Gain Error		0.30%	0.25%	0.25%
Current Measure LSB Step		10µV	2.5µV	2.5µV
+25 °C Offset		75µV	30µV	30µV
Primary	Differential Shunt Input	X	X	X
Channel	Independent Bus Voltage	X	X	X
LV Aux	Differential Shunt Input		X	
Channel	Independent Bus Voltage		X	X
VBus LSB Step	Low Voltage Bus		0.25mV	0.25mV
	High Voltage Bus	4mV	1mV/0.25mV	1mV/0.25mV
External Temperature Sensor Input			X	
HV Internal Regulator (3.3V <sub>OUT</sub> )			X	X
Fast OC/OV/UV Alert Outputs			2 Outputs	2 Outputs
Margin DAC			X	
Internal Temperature Sensor			X	X
User Select Conversion Mode/Sample Rate		X	X	X
Peak Min/Max Current Registers			X	X
Slave Address Locations		16 Addresses	55 Addresses	55 Addresses
I <sup>2</sup> C Level Translators			X	X
PMBus			X	X
I <sup>2</sup> C/SMBus		X	X	X
High Speed (3.4MHz) I <sup>2</sup> C Mode		X	X	X
External Clock Input		X	X	X
Power Shutdown Mode		X	X	X

## Absolute Maximum Ratings

VCC	6.0V
I2CVCC Voltage	6.0V
VBUS (ISL28023FR60), VREG_IN	63V
VBUS (ISL28023FR12)	16.684V
Common-Mode Input Voltage (VINP, VINM)	63V
Differential Input Voltage (VINP, VINM)	±63V
AUXV	VCC - GND
Common-Mode Input Voltage (AUXP, AUXM)	VCC - GND
Differential Input Voltage (AUXP, AUXM)	VCC - GND
Input Voltage (Digital Pins)	GND - 0.3 to I2CVCC + 0.3V
Output Voltage (Digital Pins)	GND - 0.3 to I2CVCC + 0.3V
Output Current (VREG_OUT, DAC_OUT)	10mA
Open-Drain Output Current	10mA
Open-Drain Voltage (SMBALERT1)	24V
ESD Ratings	
Human Body Model (Tested per JESD22-A114)	6kV
Machine Model (Tested per JESD22-A115)	300V
Charged Device Model (Tested per JESD22-C101)	2kV
Latch-Up (Tested per JESD-78B)	±100mA (at +125°C)

CAUTION: Do not operate at or near the maximum ratings listed for extended periods of time. Exposure to such conditions can adversely impact product reliability and result in failures not covered by warranty.

### NOTES:

- $\theta_{JA}$  is measured in free air with the component mounted on a high effective thermal conductivity test board with direct attach features. See [TB379](#).
- For  $\theta_{JC}$ , the case temperature location is the center of the exposed metal pad on the package underside.

## Thermal Information

Thermal Resistance (Typical)	$\theta_{JA}$ (°C/W)	$\theta_{JC}$ (°C/W)
24 Ld QFN (Notes 4, 5)	38	2.5
Maximum Storage Temperature Range	-65°C to +150°C	
Maximum Junction Temperature (T <sub>JMAX</sub> )	+150°C	
Pb-Free Reflow Profile	see <a href="#">TB493</a>	

## Recommended Operating Conditions

Ambient Temperature Range (T <sub>A</sub> )	-40°C to +125°C
---------------------------------------------	-----------------

**Electrical Specifications** TA = +25°C, I2CVCC = VCC = 3.3V, VINP = VBUS = 12V, VSENSE = VINP - VINM = 80mV, AUXP - AUXM = 80mV, AuxV = 3V, Conversion Time: Aux = Primary = 2.05ms, Internal AVG Aux = Primary = 128, unless otherwise specified. All voltages with respect to GND pin.

PARAMETER	SYMBOL	TEST CONDITIONS	MIN (Note 6)	TYP	MAX (Note 6)	UNIT
<b>PRIMARY CHANNEL</b>						
V <sub>SHUNT</sub> Measurement Range (V <sub>INP</sub> - V <sub>INM</sub> )	V <sub>SHUNT</sub>		0		±81.91	mV
1LSB Step Shunt Voltage	Step_shunt			2.5		µV
V <sub>SHUNT</sub> Offset Voltage	Vshunt_vos			±2.5	±50	µV
V <sub>SHUNT</sub> Offset Voltage vs Temperature	Vshunt_TC	T = -40°C to +125°C		±0.04	±0.30	µV/°C
V <sub>SHUNT</sub> Vos vs Common-Mode	Vshunt_CMRR	ISL28023FR60Z V <sub>BUS</sub> = 0V to 60V		±0.16	±1.60	µV/V
		ISL28023FR12Z V <sub>BUS</sub> = 0V to 16.384V		±0.16	±1.60	µV/V
V <sub>SHUNT</sub> Vos vs Power Supply	Vshunt_PSRR	V <sub>CC</sub> = ±10% of V <sub>CC</sub> nominal		±0.45		µV/V
V <sub>IN</sub> Input Leakage Current	I <sub>vin</sub>	V <sub>IN</sub> = V <sub>SHUNT</sub> input path selected, OC detector disabled		15	20	µA
		V <sub>IN</sub> = V <sub>SHUNT</sub> input path selected, OC detector enabled		30	40	µA
		V <sub>IN</sub> = V <sub>SHUNT</sub> input path disabled, OC detector disabled		0.05	0.10	µA
Usable Bus Voltage Measurement Range	V <sub>BUS</sub>	ISL28023FR60Z	0		60	V
		ISL28023FR12Z	0		16.384	V
1LSB Step Bus Voltage	Step_Vbus	ISL28023FR60Z		1		mV
		ISL28023FR12Z		0.25		mV
V <sub>BUS</sub> Offset Voltage	Vbus_vos	ISL28023FR60Z	-20	±1	20	mV
		ISL28023FR12Z	-5	±1.5	5	mV

**Electrical Specifications** TA = +25 °C, I2CVCC = VCC = 3.3V, VINP = VBUS = 12V, VSENSE = VINP-VINM = 80mV, AUXP-AUXM = 80mV, AuxV = 3V, Conversion Time: Aux = Primary = 2.05ms, Internal AVG Aux = Primary = 128, unless otherwise specified. All voltages with respect to GND pin.

PARAMETER	SYMBOL	TEST CONDITIONS	MIN (Note 6)	TYP	MAX (Note 6)	UNIT
VBUS Offset Voltage vs Temperature	Vbus_TC	ISL28023FR60Z; T = -40 °C to +125 °C		±4	±100	µV/°C
		ISL28023FR12Z; T = -40 °C to +125 °C		±4	±100	µV/°C
VBUS Voltage Coefficient	Vbus_Vco			50		ppm/V
VBUS Vos vs Power Supply	Vbus_PSRR	ISL28023FR60Z; VCC = ± 10% of VCC nominal		±500		µV/V
		ISL28023FR12Z VCC = ± 10% of VCC nominal		±125		µV/V
Input Impedance VBUS	Zin_Vbus	ISL28023FR60Z		600		kΩ
		ISL28023FR12Z		150		kΩ
<b>AUX CHANNEL</b>						
VSHUNT Aux Measurement Range (AuxP - AuxM)	Vshunt_aux		0		±81.91	mV
1LSB Step Shunt Aux Voltage	Step_shunt_aux			2.5		µV
VSHUNT Aux Offset Voltage	Vshunt_aux_vos			±2.5	±50	µV
VSHUNT Aux Offset Voltage vs Temperature	Vshunt_aux_TC	T = -40 °C to +125 °C		±0.01	±0.10	µV/°C
VSHUNT Aux Vos vs Common-Mode	Vshunt_aux_CMRR	VBUS = 0V to VCC		±0.1	±4	µV/V
VSHUNT Aux Vos vs Power Supply	Vshunt_aux_PSRR	VCC = ± 10% of VCC nominal		±0.45		µV/V
AUX Input Impedance	Zin_aux_in	Aux = AUXVshunt input path selected		1		MΩ
		Aux = AUXVshunt input path disabled		10		MΩ
Usable AVXV Voltage Measurement Range	Vauxv		0		VCC	V
1LSB Step AUXV Voltage	Step_auxv			100		µV
Vauxv Offset Voltage	Vauxv_vos			±0.3	±4	mV
Vauxv Offset Voltage vs Temperature	Vauxv_TC	T = -40 °C to +125 °C		±0.2	±22	µV/°C
Vauxv Vos vs Power Supply	Vauxv_PSRR	VCC = ±10% of VCC nominal		±1		mV/V
Auxv Input Impedance	Zin_auxv	Input path selected		200		kΩ
		Input path disabled		10		MΩ
<b>ADC PARAMETERS</b>						
ADC Resolution				16		Bits
Primary Shunt Voltage Gain Error				±0.05	±0.25	%
		T = -40 °C to +125 °C			±60	ppm/°C
Primary Bus Voltage Gain Error				±0.05	±0.2	%
		T = -40 °C to +125 °C		10	±70	ppm/°C
Aux Shunt Voltage Gain Error				±0.02	±0.25	%
		T = -40 °C to +125 °C			±65	ppm/°C
Aux Bus Voltage Gain Error				±0.02	±0.2	%
		T = -40 °C to +125 °C			±65	ppm/°C
Differential Nonlinearity				±1		LSB

**Electrical Specifications** TA = +25 °C, I2CVCC = VCC = 3.3V, VINP = VBUS = 12V, VSENSE = VINP-VINM = 80mV, AUXP-AUXM = 80mV, AuxV = 3V, Conversion Time: Aux = Primary = 2.05ms, Internal AVG Aux = Primary = 128, unless otherwise specified. All voltages with respect to GND pin.

PARAMETER	SYMBOL	TEST CONDITIONS	MIN (Note 6)	TYP	MAX (Note 6)	UNIT
<b>ADC TIMING</b>						
ADC Conversion Time Resolution	$t_s$ Power-up	ADC[2:0] = 0h		64	70.4	$\mu$ s
		ADC[2:0] = 1h		128	140.8	$\mu$ s
		ADC[2:0] = 2h		256	281.6	$\mu$ s
		ADC[2:0] = 3h		512	563.2	$\mu$ s
		ADC[2:0] = 4, 5h		1.024	1.126	ms
		ADC[2:0] = 6, 7h		2.048	2.253	ms
<b>THRESHOLD DETECTORS</b>						
Overvoltage (OV) $V_{BUS}$ Threshold Voltage Range		Vbus_Thres_Rng[2:0] = ALL	25		125	% of FS
Overvoltage (OV) $V_{BUS}$ Threshold DAC Step Size		Vbus_Thres_Rng[2:0] = ALL		1.56		% of FS
Undervoltage (UV) $V_{BUS}$ Threshold Voltage Range		Vbus_Thres_Rng[2:0] = ALL	0		100	% of FS
Undervoltage (UV) $V_{BUS}$ Threshold DAC Step Size		Vbus_Thres_Rng[2:0] = ALL		1.56		% of FS
$V_{BUS}$ Threshold Detector Full-Scale Settings ISL28023FR60Z		Vbus_Thres_Rng[2:0] = 0; OT_SEL = 0		48		V
		Vbus_Thres_Rng[2:0] = 1; OT_SEL = 0		24		V
		Vbus_Thres_Rng[2:0] = 2; OT_SEL = 0		12		V
		Vbus_Thres_Rng[2:0] = 3; OT_SEL = 0		5		V
		Vbus_Thres_Rng[2:0] = 4; OT_SEL = 0		3.3		V
		Vbus_Thres_Rng[2:0] = 5; OT_SEL = 0		2.5		V
$V_{BUS}$ Threshold Detector Full-Scale Settings ISL28023FR12Z		Vbus_Thres_Rng[2:0] = 0; OT_SEL = 0		12		V
		Vbus_Thres_Rng[2:0] = 1; OT_SEL = 0		6		V
		Vbus_Thres_Rng[2:0] = 2; OT_SEL = 0		3		V
		Vbus_Thres_Rng[2:0] = 3; OT_SEL = 0		2.5		V
		Vbus_Thres_Rng[2:0] = 4; OT_SEL = 0		0.825		V
		Vbus_Thres_Rng[2:0] = 5; OT_SEL = 0		0.625		V
Over-Temperature Threshold Detector Range		OT_SEL = 1	-40		135	°C
Over-Temperature Threshold Detector Resolution Error				$\pm$ 5		°C
Overcurrent (OC) $V_{SHUNT}$ Threshold Voltage Range		OCRNG = ALL	25		125	% of FS
Overcurrent (OC) $V_{SHUNT}$ Threshold DAC Step Size		OCRNG = ALL		1.56		% of FS
$V_{SHUNT}$ Threshold Detector Full-Scale Settings		OCRNG = 0		80		mV
		OCRNG = 1		40		mV



**Electrical Specifications** TA = +25 °C, I2CVCC = VCC = 3.3V, VINP = VBUS = 12V, VSENSE = VINP-VINM = 80mV, AUXP-AUXM = 80mV, AuxV = 3V, Conversion Time: Aux = Primary = 2.05ms, Internal AVG Aux = Primary = 128, unless otherwise specified. All voltages with respect to GND pin.

PARAMETER	SYMBOL	TEST CONDITIONS	MIN (Note 6)	TYP	MAX (Note 6)	UNIT
<b>MARGINING DAC, ANALOG OUTPUT</b>						
Resolution				8		Bits
DNL				±1		LSB
INL		MDAC[7:0] = 0 to 256		±3		LSB
Gain Error		DAC_MS[2:0] = 0		±2.5		%
Offset Error		DAC_MS[2:0] = 0		±2		mV
Output Voltage			0.055		2*Vms	V
DAC Mid-Scale	VMS	DAC_MS[2:0] = 0		0.4		V
		DAC_MS[2:0] = 1		0.5		V
		DAC_MS[2:0] = 2		0.6		V
		DAC_MS[2:0] = 3		0.7		V
		DAC_MS[2:0] = 4		0.8		V
		DAC_MS[2:0] = 5		0.9		V
		DAC_MS[2:0] = 6		1.0		V
		DAC_MS[2:0] = 7		1.2		V
Slew Rate				1		V/μs
Output Current				1		mA
Short-Circuit Current		DAC_OUT = VCC			17	mA
		DAC_OUT = GND			4.2	mA
Start-Up Time				100		μs
<b>VOLTAGE REGULATOR SPECIFICATION</b>						
Input Voltage at REG_IN			4.5		60	V
Output Regulation Voltage			3.18	3.30	3.35	V
Line Regulation		V <sub>IN</sub> = 4.5V to 60V		53	150	μV/V
Load Regulation		I <sub>LOAD</sub> = 3.3mA to 6mA		0.2	1.4	mV/mA
Capacitance Drive			0.01		10	μF
Output Short-Circuit		T = -40 °C to +125 °C		10		mA
Max Load Current		T = -40 °C to +125 °C		6		mA
Start-Up Time				1		ms
<b>TEMPERATURE SENSOR</b>						
Temperature Sensor Measurement Range			-40		125	°C
Temperature Accuracy		T = +25 °C		+1		°C
Temperature Resolution				0.5		°C
Measurement Time				0.5		ms
<b>SMBus/I<sup>2</sup>C INTERFACE SPECIFICATIONS</b>						
SMBDAT and SMBCLK Input Buffer LOW Voltage	V <sub>IL</sub>		-0.3		0.3 x I2CVCC	V
SMBDAT and SMBCLK Input Buffer HIGH Voltage	V <sub>IH</sub>		0.7 x I2CVCC		I2CVCC + 0.3	V

**Electrical Specifications** TA = +25 °C, I2CVCC = VCC = 3.3V, VINP = VBUS = 12V, VSENSE = VINP-VINM = 80mV, AUXP-AUXM = 80mV, AuxV = 3V, Conversion Time: Aux = Primary = 2.05ms, Internal AVG Aux = Primary = 128, unless otherwise specified. All voltages with respect to GND pin.

PARAMETER	SYMBOL	TEST CONDITIONS	MIN (Note 6)	TYP	MAX (Note 6)	UNIT
SMBDAT and SMBCLK Input Buffer Hysteresis	Hysteresis			0.05 x I2CVCC		V
SMBDAT Output Buffer LOW Voltage, Sinking 3mA	V <sub>OL</sub>	I2CVCC = 5V, I <sub>OL</sub> = 3mA	0	0.02	0.4	V
SMBDAT and SMBCLK Pin Capacitance	C <sub>PIN</sub>	T <sub>A</sub> = +25 °C, f = 1MHz, I2CVCC = 5V, V <sub>IN</sub> = 0V, V <sub>OUT</sub> = 0V			10	pF
SMBCLK Frequency	f <sub>SMBCLK</sub>				400	kHz
Pulse Width Suppression Time at SMBDAT and SMBCLK Inputs	t <sub>IN</sub>	Any pulse narrower than the max spec is suppressed			50	ns
SMBCLK Falling Edge to SMBDAT Output Data Valid	t <sub>AA</sub>	SMBCLK falling edge crossing 30% of I2CVCC, until SMBDAT exits the 30% to 70% of I <sup>2</sup> CVCC window			900	ns
Time the Bus Must be Free Before the Start of a New Transmission	t <sub>BUF</sub>	SMBDAT crossing 70% of I2CVCC during a STOP condition, to SMBDAT crossing 70% of I2CVCC during the following START condition	1300			ns
Clock LOW Time	t <sub>LOW</sub>	Measured at the 30% of I2CVCC crossing	1300			ns
Clock HIGH Time	t <sub>HIGH</sub>	Measured at the 70% of I2CVCC crossing	600			ns
START Condition Setup Time	t <sub>SU:STA</sub>	SMBCLK rising edge to SMBDAT falling edge. Both crossing 70% of I2CVCC	600			ns
START Condition Hold Time	t <sub>HD:STA</sub>	From SMBDAT falling edge crossing 30% of I2CVCC to SMBCLK falling edge crossing 70% of I2CVCC	600			ns
Input Data Setup Time	t <sub>SU:DAT</sub>	From SMBDAT exiting the 30% to 70% of V <sub>CC</sub> window, to SMBCLK rising edge crossing 30% of I2CVCC	100			ns
Input Data Hold Time	t <sub>HD:DAT</sub>	From SMBCLK falling edge crossing 30% of I2CVCC to SMBDAT entering the 30% to 70% of I2CVCC window	20		900	ns
STOP Condition Setup Time	t <sub>SU:STO</sub>	From SMBCLK rising edge crossing 70% of I2CVCC, to SMBDAT rising edge crossing 30% of I2CVCC	600			ns
STOP Condition Hold Time	t <sub>HD:STO</sub>	From SMBDAT rising edge to SMBCLK falling edge. Both crossing 70% of I2CVCC	600			ns
Output Data Hold Time	t <sub>DH</sub>	From SMBCLK falling edge crossing 30% of I2CVCC, until SMBDAT enters the 30% to 70% of I2CVCC window	0			ns
SMBDAT and SMBCLK Rise Time	t <sub>R</sub>	From 30% to 70% of I2CVCC	20 + 0.1 x C <sub>b</sub>		300	ns
SMBDAT and SMBCLK Fall Time	t <sub>F</sub>	From 70% to 30% of I2CVCC	20 + 0.1 x C <sub>b</sub>		300	ns
Capacitive Loading of SMBDAT or SMBCLK	C <sub>b</sub>	Total on-chip and off-chip	10		400	pF
SMBDAT and SMBCLK Bus Pull-up Resistor Off-chip	R <sub>PU</sub>	Maximum is determined by t <sub>R</sub> and t <sub>F</sub> For C <sub>b</sub> = 400pF, max is about 2kΩ~2.5kΩ For C <sub>b</sub> = 40pF, max is about 15kΩ~20kΩ	1			kΩ

**Electrical Specifications** TA = +25 °C, I2CVCC = VCC = 3.3V, VINP = VBUS = 12V, VSENSE = VINP-VINM = 80mV, AUXP-AUXM = 80mV, AuxV = 3V, Conversion Time: Aux = Primary = 2.05ms, Internal AVG Aux = Primary = 128, unless otherwise specified. All voltages with respect to GND pin.

PARAMETER	SYMBOL	TEST CONDITIONS	MIN (Note 6)	TYP	MAX (Note 6)	UNIT
<b>POWER SUPPLY</b>						
Power Supply Voltage at V <sub>CC</sub>	V <sub>vcc</sub>		3.0	3.3	5.5	V
Power Supply Voltage at I <sup>2</sup> CVCC	Vi2cvcc	f = DC to 400kHz	1.2	3.3	5.5	V
Only ADC in Conversion Mode		All other blocks are disabled		690	830	μA
Only ADC in Idle Mode		All other blocks are disabled		640	705	μA
Only Threshold Detectors		All three detectors are active		760	945	μA
Only Margin DAC		All other blocks are disabled		240	286	μA
Fully Enabled Chip Current		All functional blocks enabled		1240	1545	μA
Fully Disabled Chip Current		All functional blocks disabled		5	15	μA
Voltage Regulator	lvreg_in	Vreg_in = 4.5V to 60V; Rload = open		26	35	μA
I <sup>2</sup> C Supply Current	li2cvcc	SMBCLK = 100kHz; I2CVCC = 3.3V		15		μA
I <sup>2</sup> C Idle Supply Current	li2cvcc_pd	Input signals are static		100		nA

**NOTE:**

6. Parameters with MIN and/or MAX limits are 100% tested at +25 °C, unless otherwise specified. Compliance to datasheet limits is assured by one or more of the following methods: production test, characterization and design.

**Typical Performance Curves**  $T_A = +25^\circ\text{C}$ ,  $V_{CC} = 3.3\text{V}$ ,  $V_{INP} = V_{BUS} = 12\text{V}$ ,  $AUXP = AUXV = 3\text{V}$ ,  
 $V_{SHUNT} = VAUXSHUNT = 80\text{mV}$ , Conversion Time: Aux = Primary = 2.05ms, Internal AVG Aux = Primary = 128; unless otherwise specified.

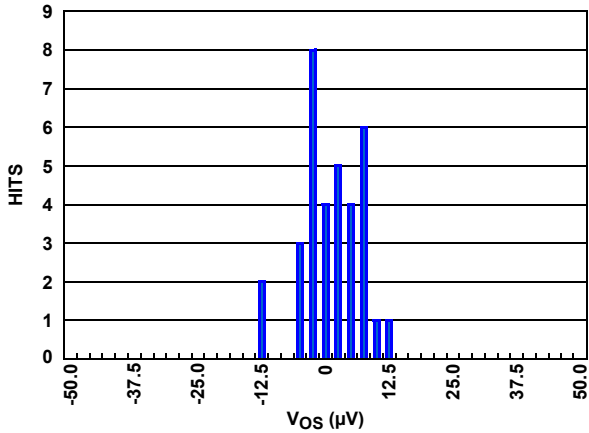

FIGURE 3. PRIMARY  $V_{SHUNT} V_{OS}$

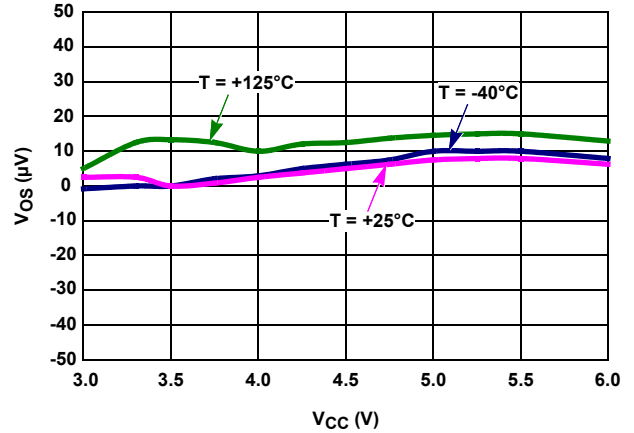

FIGURE 4. PRIMARY  $V_{SHUNT} V_{OS}$  vs  $V_{CC}$

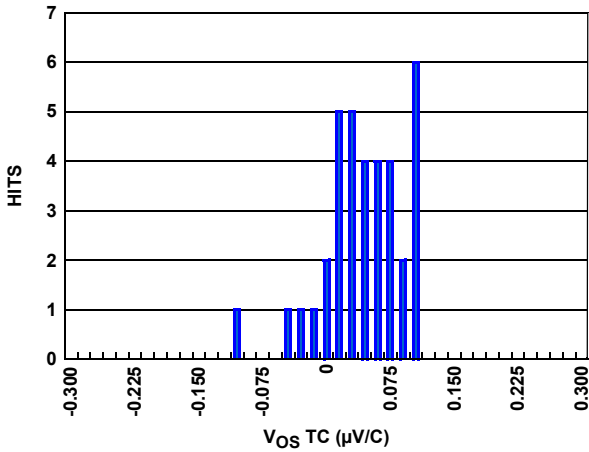

FIGURE 5. PRIMARY  $V_{SHUNT} V_{OS} TC$  ( $-40^\circ\text{C}$  TO  $+125^\circ\text{C}$ )

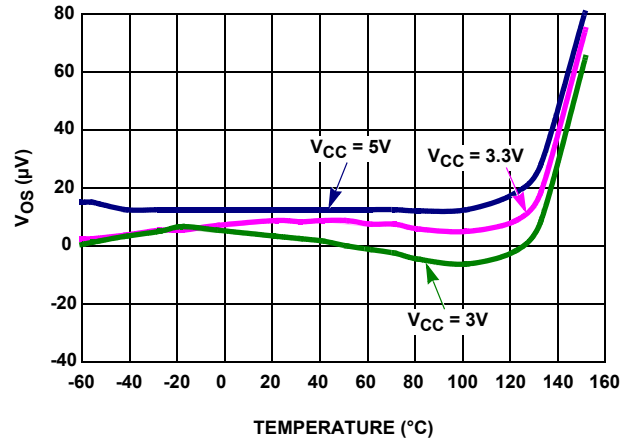

FIGURE 6. PRIMARY  $V_{SHUNT} V_{OS}$  vs TEMPERATURE

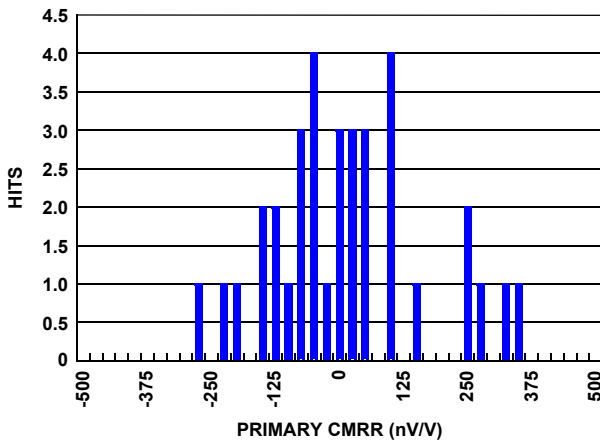

FIGURE 7. PRIMARY  $V_{SHUNT} CMRR$ ,  $CMV = (0\text{V TO } 60\text{V})$

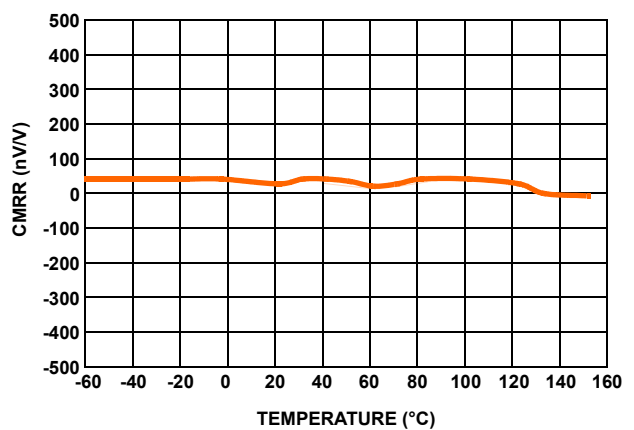

FIGURE 8. PRIMARY  $V_{SHUNT} CMRR$  vs TEMPERATURE ( $CMV = 0\text{V TO } 60\text{V}$ )

# Typical Performance Curves

$T_A = +25^\circ\text{C}$ ,  $V_{CC} = 3.3\text{V}$ ,  $V_{INP} = V_{BUS} = 12\text{V}$ ,  $AUXP = AUXV = 3\text{V}$ ,  
 $V_{SHUNT} = V_{AUXSHUNT} = 80\text{mV}$ , Conversion Time: Aux = Primary = 2.05ms, Internal AVG Aux = Primary = 128; unless otherwise specified. (Continued)

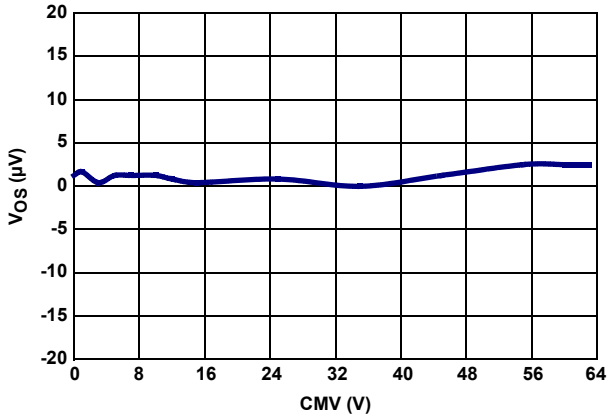

FIGURE 9. PRIMARY  $V_{SHUNT}$  CMRR vs CMV

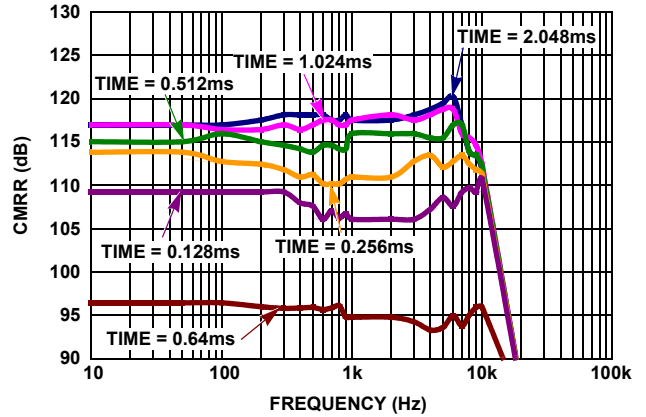

FIGURE 10. PRIMARY  $V_{SHUNT}$  AC CMRR vs FREQUENCY

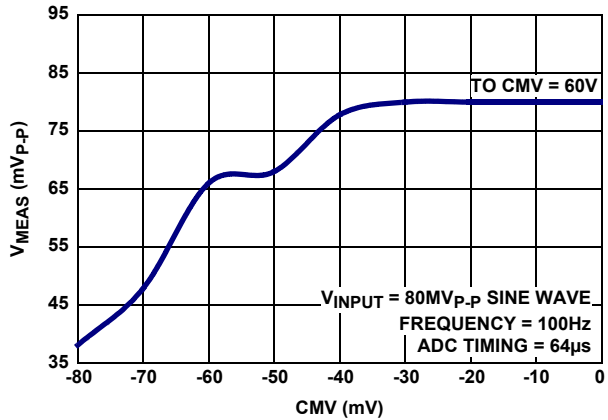

FIGURE 11. PRIMARY  $V_{SHUNT}$  COMMON-MODE RANGE

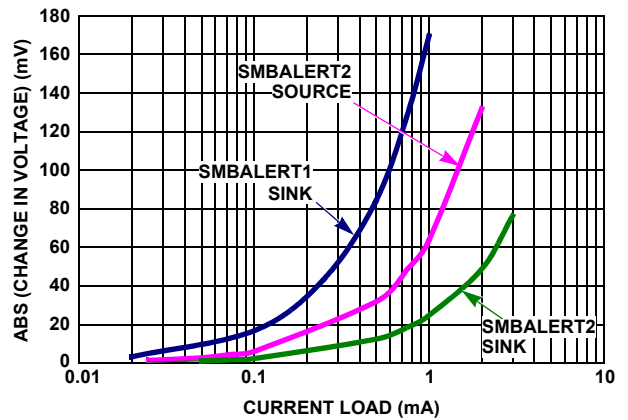

FIGURE 12. SMBALERT CURRENT DRIVES

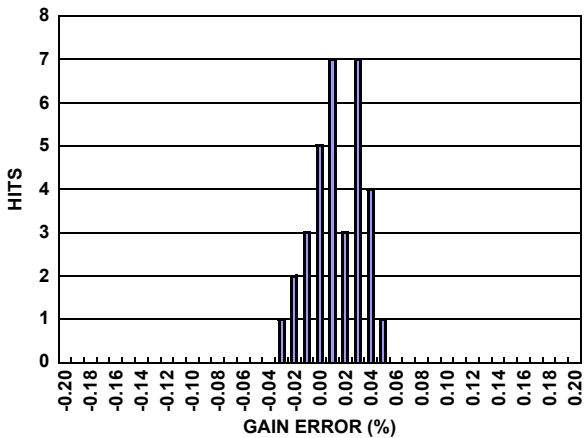

FIGURE 13. PRIMARY  $V_{SHUNT}$  ADC GAIN ERROR

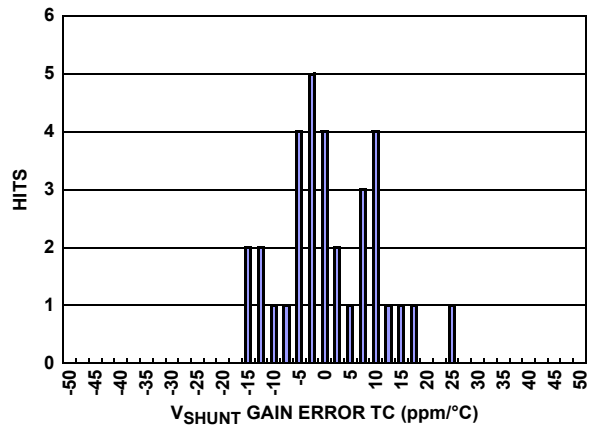

FIGURE 14. PRIMARY  $V_{SHUNT}$  ADC GAIN ERROR TC

# Typical Performance Curves

$T_A = +25^\circ\text{C}$ ,  $V_{CC} = 3.3\text{V}$ ,  $V_{INP} = V_{BUS} = 12\text{V}$ ,  $AUXP = AUXV = 3\text{V}$ ,  
 $V_{SHUNT} = V_{AUXSHUNT} = 80\text{mV}$ , Conversion Time: Aux = Primary = 2.05ms, Internal AVG Aux = Primary = 128; unless otherwise specified. (Continued)

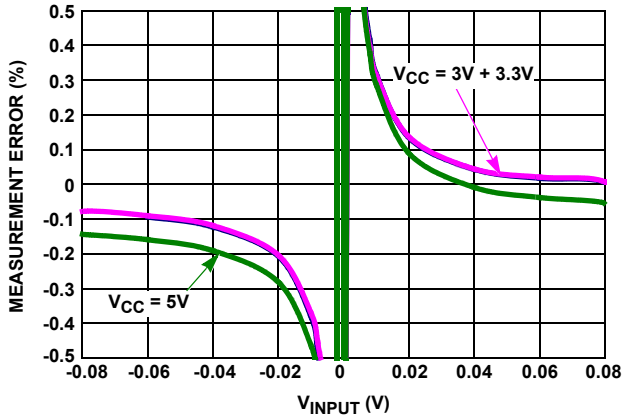

FIGURE 15. PRIMARY  $V_{SHUNT}$  MEASUREMENT ERROR vs INPUT

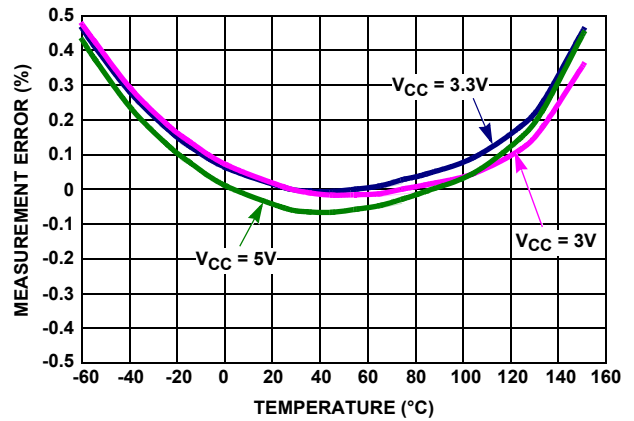

FIGURE 16. PRIMARY  $V_{SHUNT}$  MEASUREMENT ERROR vs TEMPERATURE

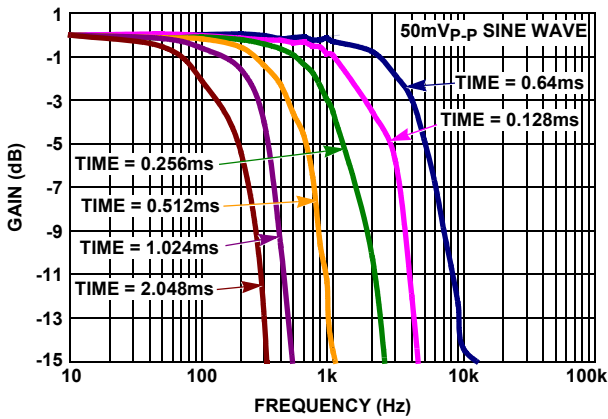

FIGURE 17. PRIMARY  $V_{SHUNT}$  BANDWIDTH vs ADC TIMING

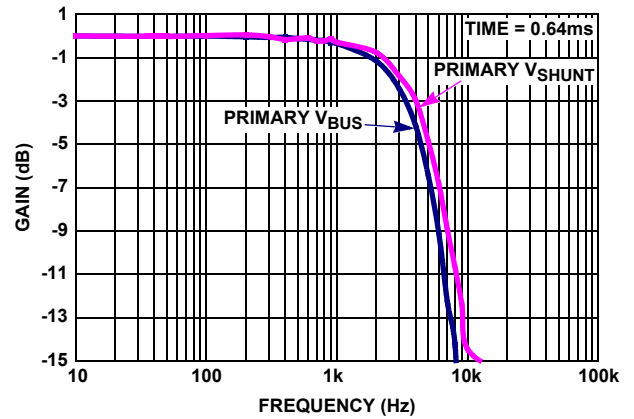

FIGURE 18. PRIMARY  $V_{SHUNT}$  AND  $V_{BUS}$  vs FREQUENCY

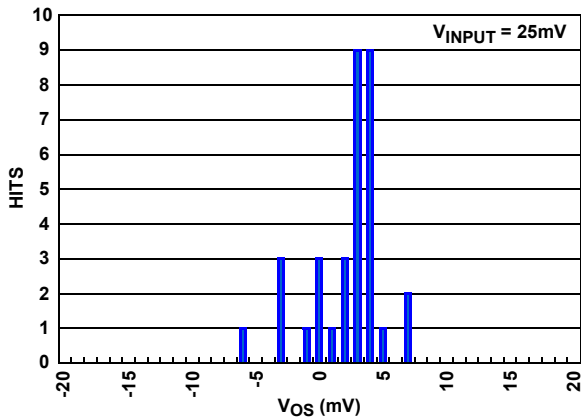

FIGURE 19. PRIMARY  $V_{BUS}$   $V_{OS}$

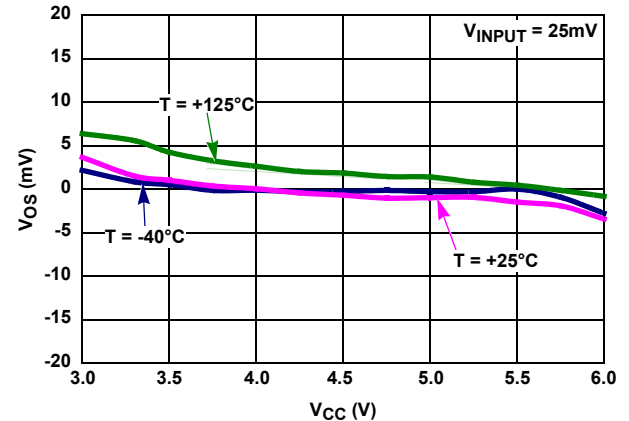

FIGURE 20. PRIMARY  $V_{BUS}$   $V_{OS}$  vs  $V_{CC}$

# Typical Performance Curves

$T_A = +25^\circ\text{C}$ ,  $V_{CC} = 3.3\text{V}$ ,  $V_{INP} = V_{BUS} = 12\text{V}$ ,  $AUXP = AUXV = 3\text{V}$ ,  
 $V_{SHUNT} = V_{AUXSHUNT} = 80\text{mV}$ , Conversion Time: Aux = Primary = 2.05ms, Internal AVG Aux = Primary = 128; unless otherwise specified. (Continued)

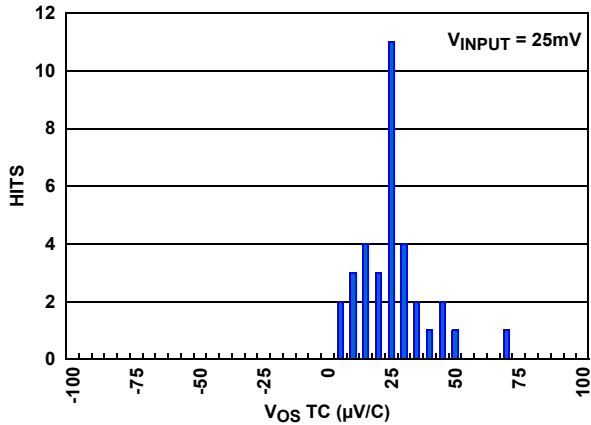

FIGURE 21. PRIMARY  $V_{BUS}$   $V_{OS}$  TC

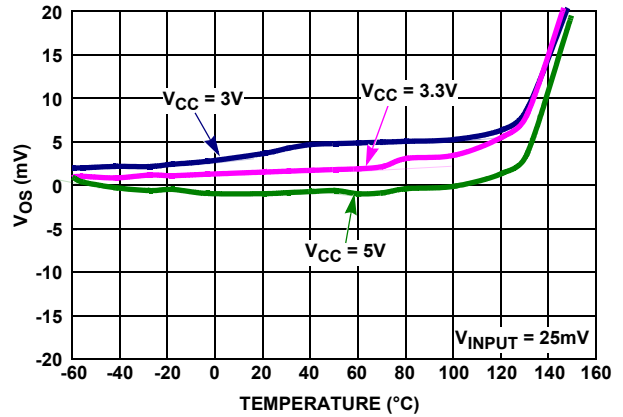

FIGURE 22. PRIMARY  $V_{BUS}$   $V_{OS}$  vs TEMPERATURE

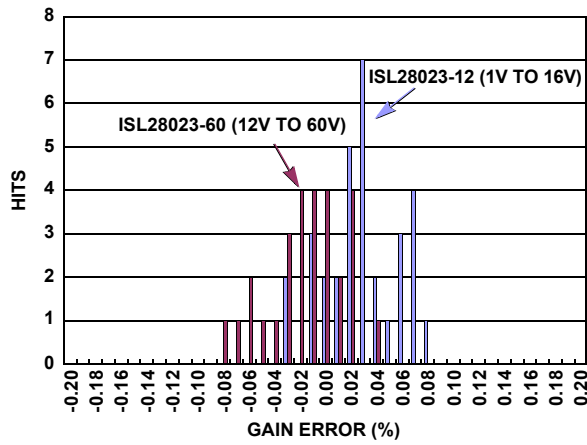

FIGURE 23. PRIMARY  $V_{BUS}$  ADC GAIN ERROR

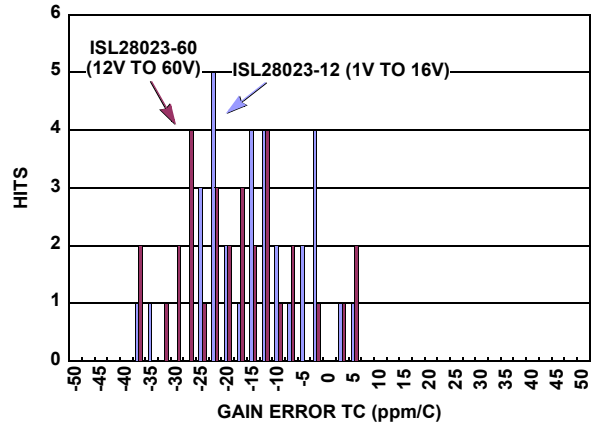

FIGURE 24. PRIMARY  $V_{BUS}$  ADC GAIN ERROR TC

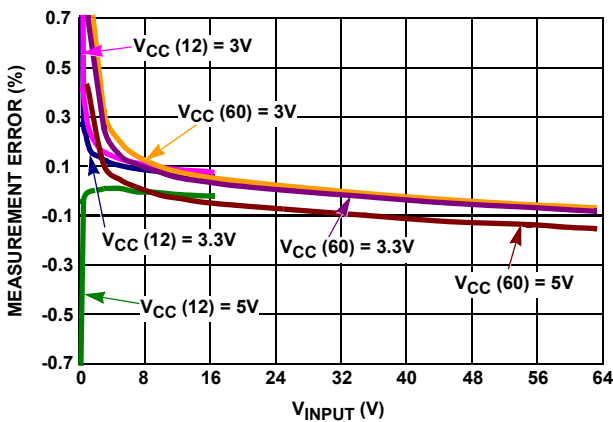

FIGURE 25. PRIMARY  $V_{BUS}$  MEASUREMENT ERROR vs INPUT

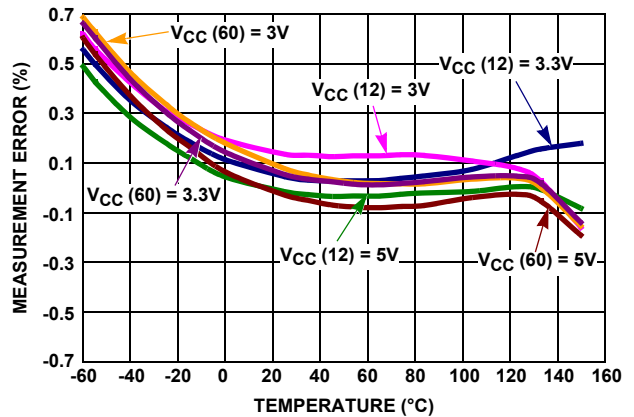

FIGURE 26. PRIMARY  $V_{BUS}$  MEASUREMENT ERROR vs TEMPERATURE

# Typical Performance Curves

$T_A = +25^\circ\text{C}$ ,  $V_{CC} = 3.3\text{V}$ ,  $V_{INP} = V_{BUS} = 12\text{V}$ ,  $AUXP = AUXV = 3\text{V}$ ,  
 $V_{SHUNT} = V_{AUXSHUNT} = 80\text{mV}$ , Conversion Time: Aux = Primary = 2.05ms, Internal AVG Aux = Primary = 128; unless otherwise specified. (Continued)

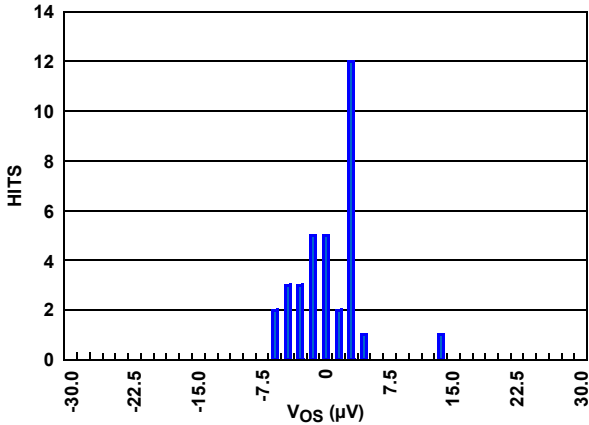

FIGURE 27. AUXILIARY  $V_{SHUNT}$   $V_{OS}$

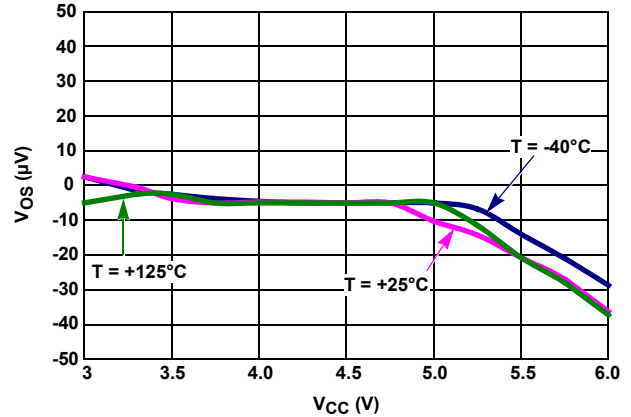

FIGURE 28. AUXILIARY  $V_{SHUNT}$   $V_{OS}$  vs  $V_{CC}$

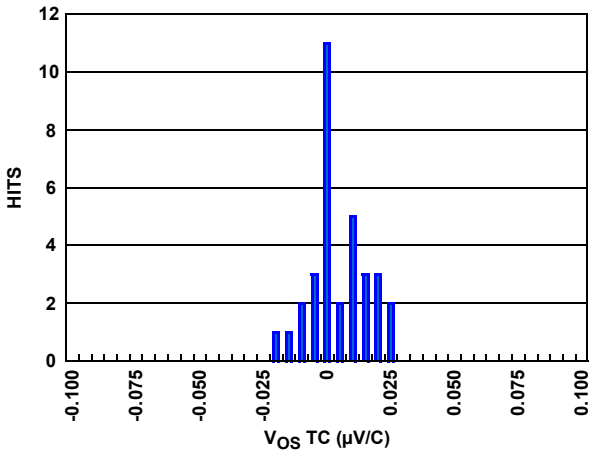

FIGURE 29. AUXILIARY  $V_{SHUNT}$   $V_{OS}$  TC ( $-40^\circ\text{C}$  TO  $+125^\circ\text{C}$ )

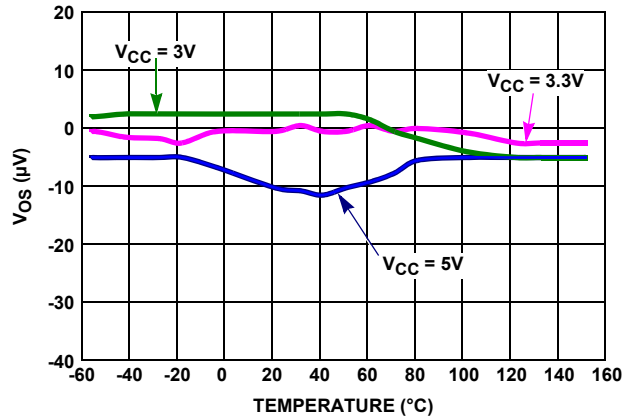

FIGURE 30. AUXILIARY  $V_{SHUNT}$   $V_{OS}$  vs TEMPERATURE

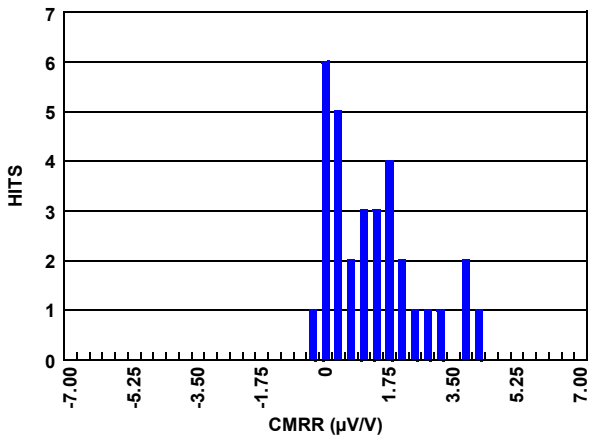

FIGURE 31. AUXILIARY  $V_{SHUNT}$  CMRR, CMV = (0V TO 3.3V)

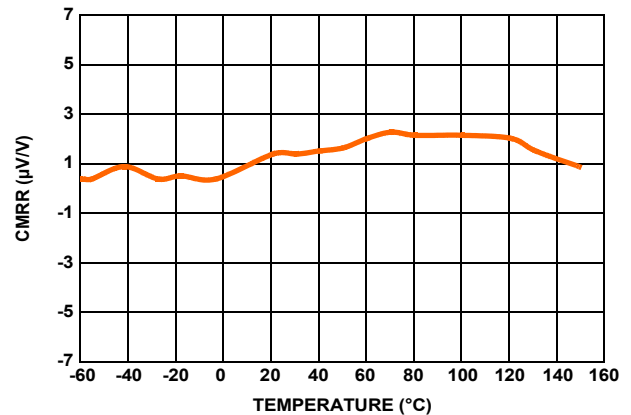

FIGURE 32. AUXILIARY  $V_{SHUNT}$  CMRR vs TEMPERATURE (CMV = 0V TO 3.3V)



# Typical Performance Curves

$T_A = +25^\circ\text{C}$ ,  $V_{CC} = 3.3\text{V}$ ,  $V_{INP} = V_{BUS} = 12\text{V}$ ,  $AUXP = AUXV = 3\text{V}$ ,  
 $V_{SHUNT} = V_{AUXSHUNT} = 80\text{mV}$ , Conversion Time: Aux = Primary = 2.05ms, Internal AVG Aux = Primary = 128; unless otherwise specified. (Continued)

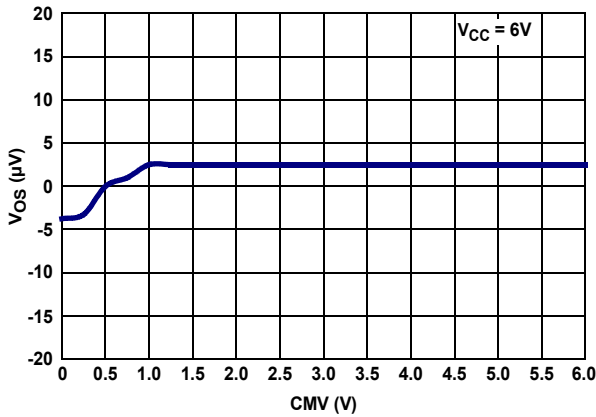

FIGURE 33. AUXILIARY  $V_{SHUNT}$   $V_{OS}$  vs CMV

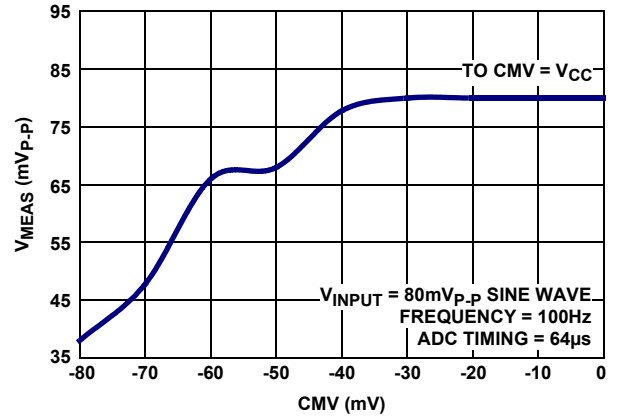

FIGURE 34. AUXILIARY  $V_{SHUNT}$  COMMON-MODE RANGE

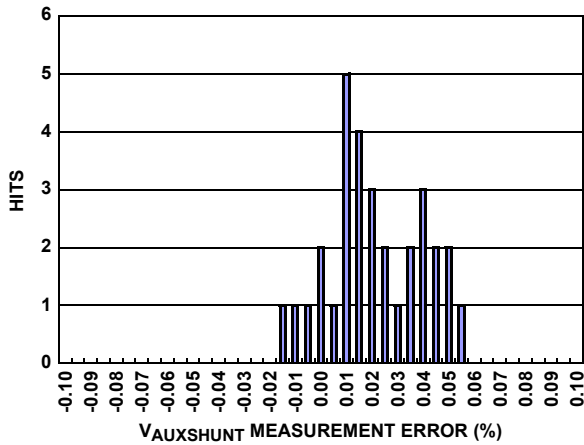

FIGURE 35. AUXILIARY  $V_{SHUNT}$  ADC GAIN ERROR

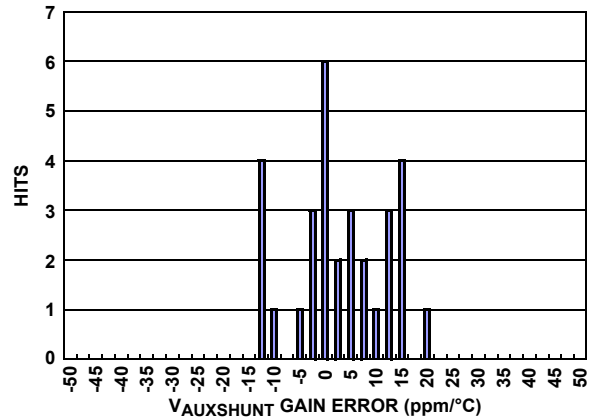

FIGURE 36. AUXILIARY  $V_{SHUNT}$  ADC GAIN ERROR TC

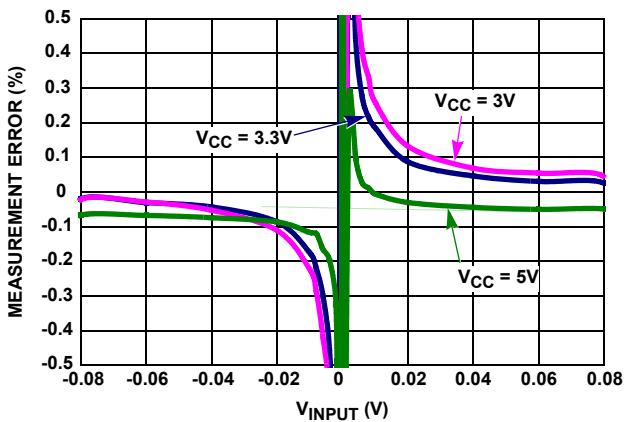

FIGURE 37. AUXILIARY  $V_{SHUNT}$  MEASUREMENT ERROR vs INPUT

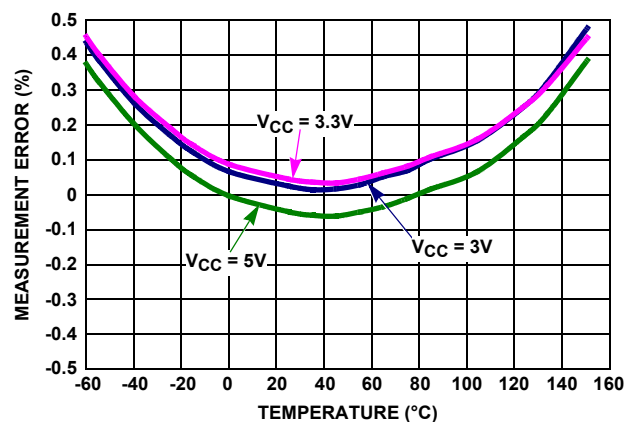

FIGURE 38. AUXILIARY  $V_{SHUNT}$  MEASUREMENT ERROR vs TEMPERATURE

# Typical Performance Curves

$T_A = +25^\circ\text{C}$ ,  $V_{CC} = 3.3\text{V}$ ,  $V_{INP} = V_{BUS} = 12\text{V}$ ,  $AUXP = AUXV = 3\text{V}$ ,  
 $V_{SHUNT} = VAUXSHUNT = 80\text{mV}$ , Conversion Time: Aux = Primary = 2.05ms, Internal AVG Aux = Primary = 128; unless otherwise specified. (Continued)

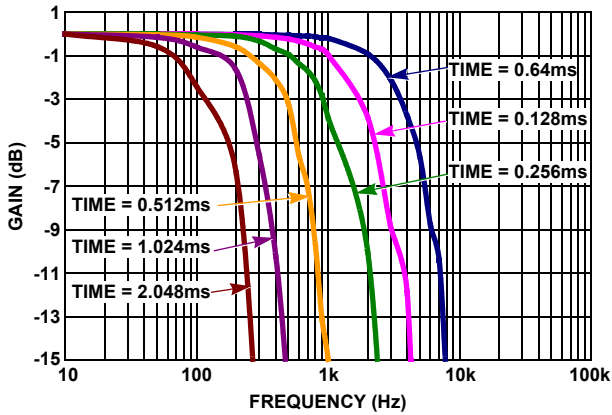

FIGURE 39. AUXILIARY  $V_{BUS}$  BANDWIDTH vs ADC TIMING

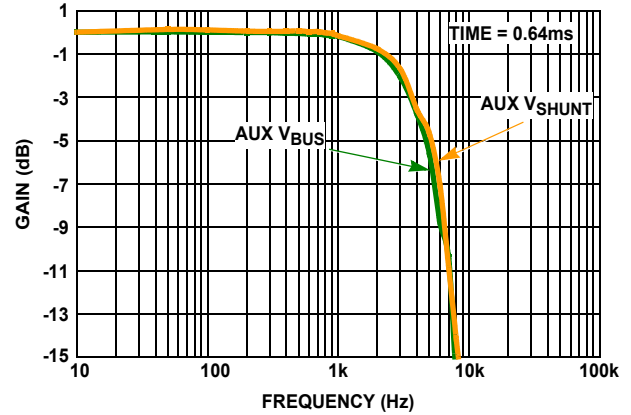

FIGURE 40. AUXILIARY  $V_{SHUNT}$  AND  $V_{BUS}$  vs FREQUENCY

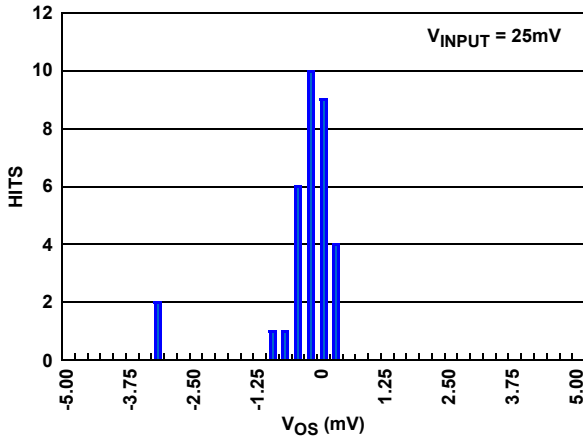

FIGURE 41. AUXILIARY  $V_{BUS}$   $V_{OS}$

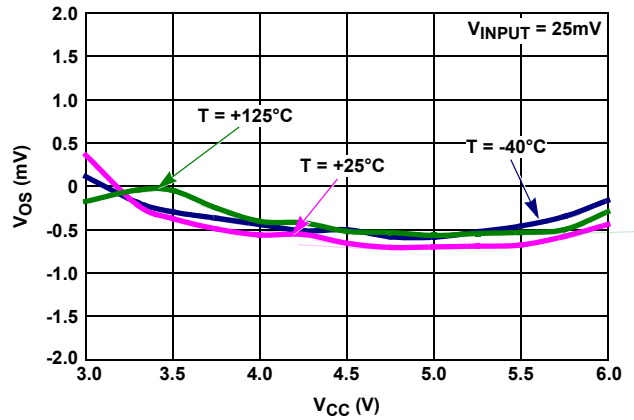

FIGURE 42. AUXILIARY  $V_{BUS}$   $V_{OS}$  vs  $V_{CC}$

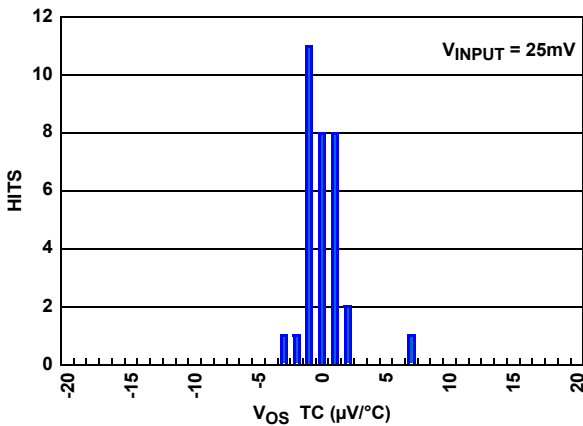

FIGURE 43. AUXILIARY  $V_{BUS}$   $V_{OS}$  TC

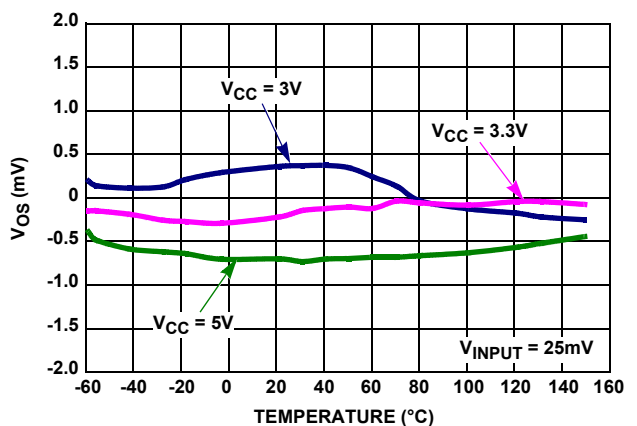

FIGURE 44. AUXILIARY  $V_{BUS}$   $V_{OS}$  vs TEMPERATURE

# Typical Performance Curves

$T_A = +25^\circ\text{C}$ ,  $V_{CC} = 3.3\text{V}$ ,  $V_{INP} = V_{BUS} = 12\text{V}$ ,  $AUXP = AUXV = 3\text{V}$ ,  
 $V_{SHUNT} = V_{AUXSHUNT} = 80\text{mV}$ , Conversion Time: Aux = Primary = 2.05ms, Internal AVG Aux = Primary = 128; unless otherwise specified. (Continued)

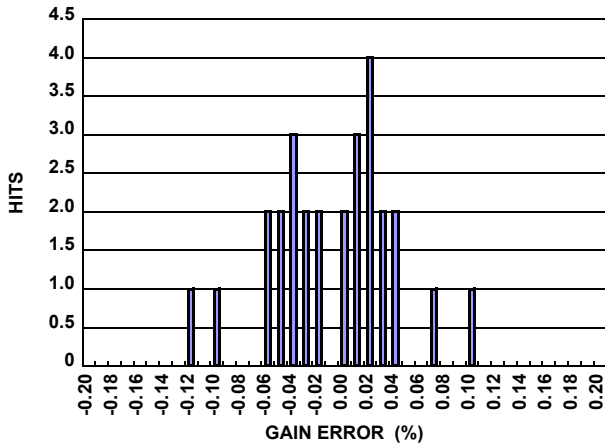

FIGURE 45. AUXILIARY  $V_{BUS}$  ADC GAIN ERROR

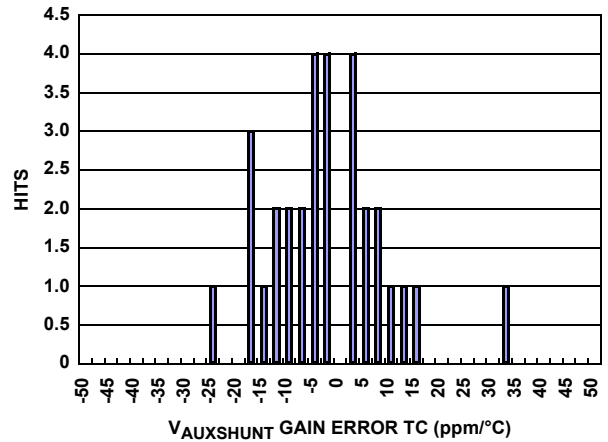

FIGURE 46. AUXILIARY  $V_{BUS}$  ADC GAIN ERROR TC

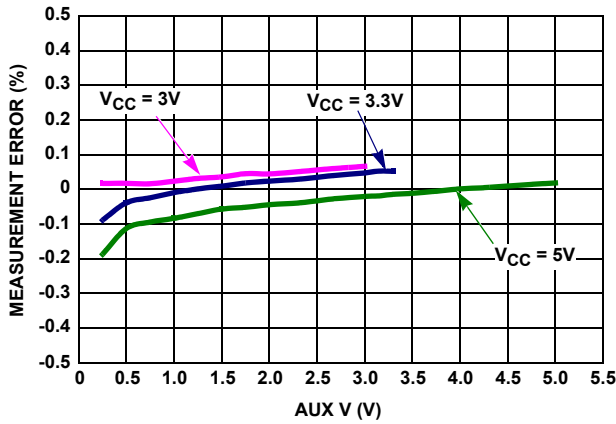

FIGURE 47. AUXILIARY  $V_{BUS}$  MEASUREMENT ERROR vs INPUT

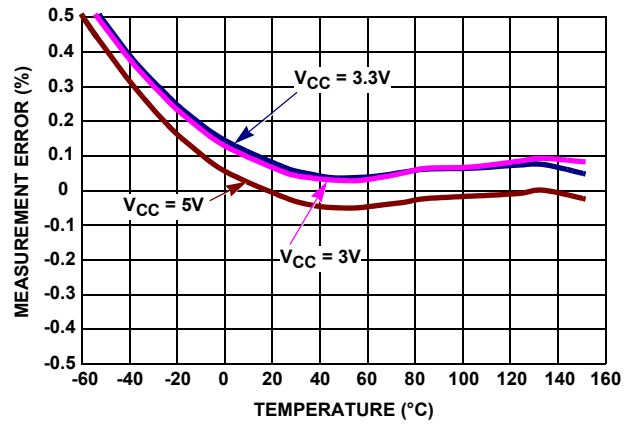

FIGURE 48. AUXILIARY  $V_{BUS}$  MEASUREMENT ERROR vs TEMPERATURE

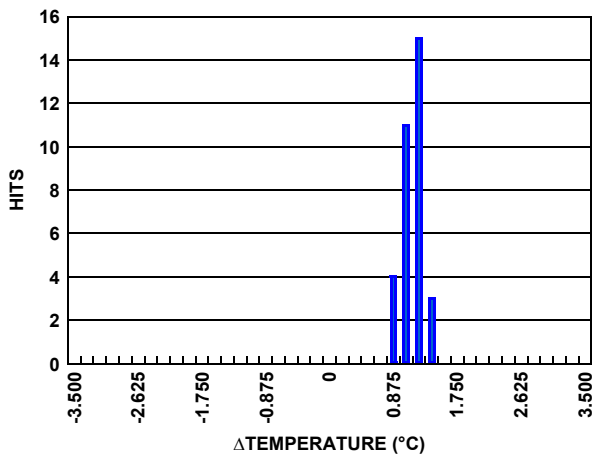

FIGURE 49. INTERNAL TEMPERATURE ACCURACY AT  $T = +25^\circ\text{C}$

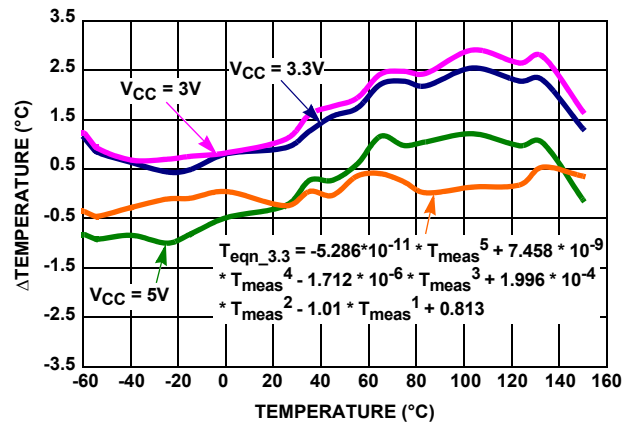

FIGURE 50. INTERNAL TEMPERATURE SENSOR ACCURACY

# Typical Performance Curves

$T_A = +25^\circ\text{C}$ ,  $V_{CC} = 3.3\text{V}$ ,  $V_{INP} = V_{BUS} = 12\text{V}$ ,  $AUXP = AUXV = 3\text{V}$ ,  
 $V_{SHUNT} = VAUXSHUNT = 80\text{mV}$ , Conversion Time: Aux = Primary = 2.05ms, Internal AVG Aux = Primary = 128; unless otherwise specified. (Continued)

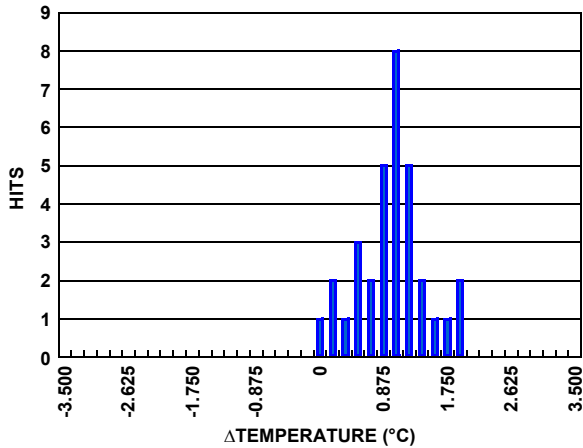

FIGURE 51. INTERNAL TEMPERATURE ACCURACY AT T = -40°C

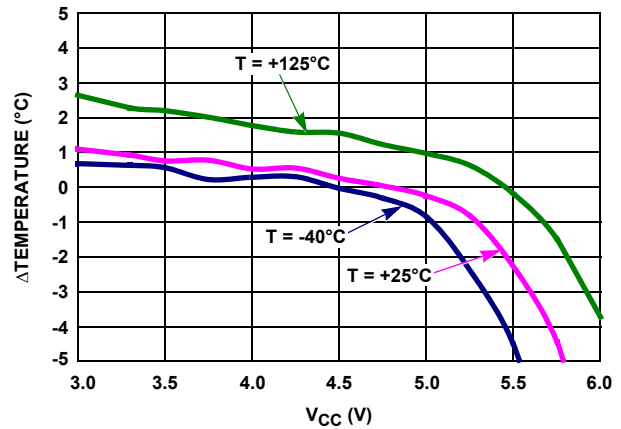

FIGURE 52. INTERNAL TEMPERATURE ACCURACY vs  $V_{CC}$

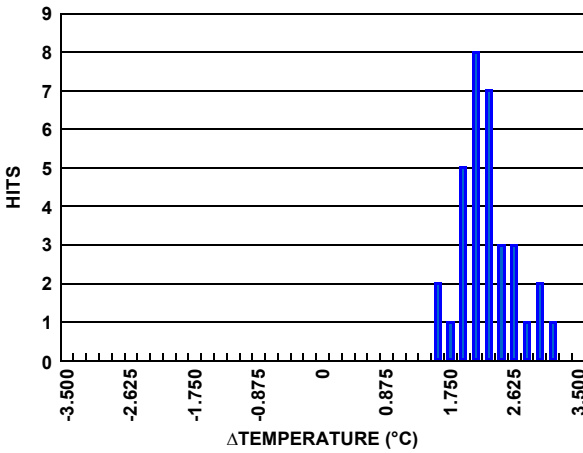

FIGURE 53. INTERNAL TEMPERATURE ACCURACY AT T = +85°C

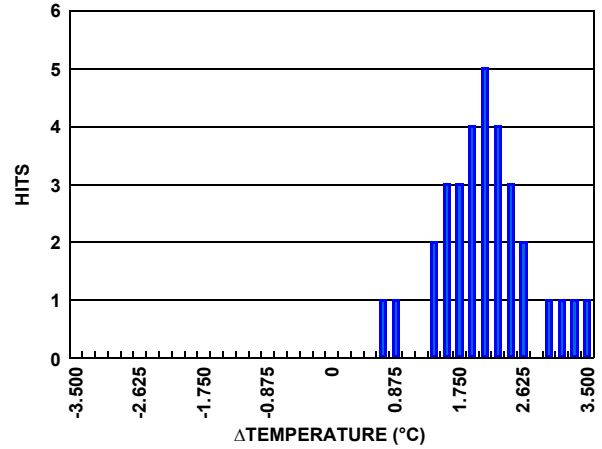

FIGURE 54. INTERNAL TEMPERATURE ACCURACY AT T = +125°C

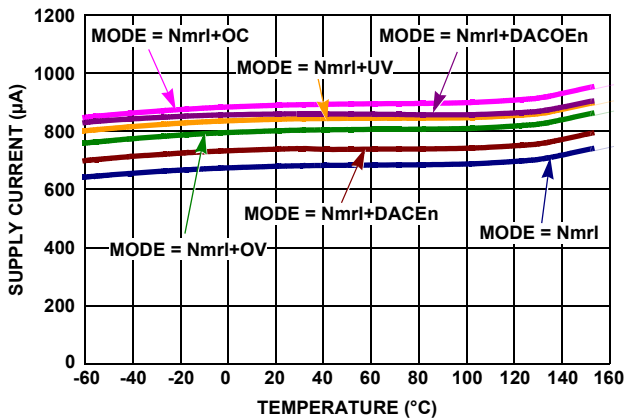

FIGURE 55. SUPPLY CURRENT vs TEMPERATURE

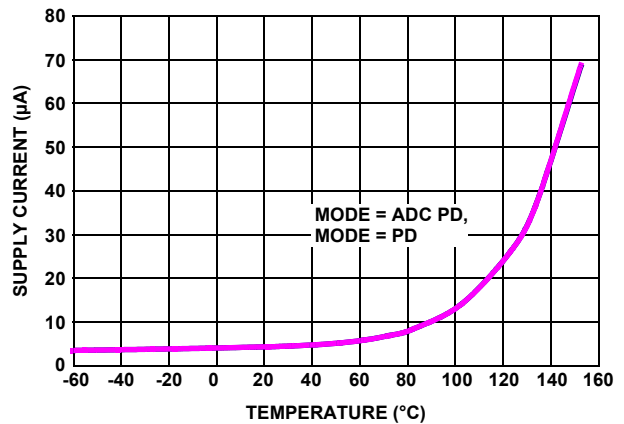

FIGURE 56. POWER-DOWN SUPPLY CURRENT vs TEMPERATURE

# Typical Performance Curves

$T_A = +25^\circ\text{C}$ ,  $V_{CC} = 3.3\text{V}$ ,  $V_{INP} = V_{BUS} = 12\text{V}$ ,  $AUXP = AUXV = 3\text{V}$ ,  
 $V_{SHUNT} = VAUXSHUNT = 80\text{mV}$ , Conversion Time: Aux = Primary = 2.05ms, Internal AVG Aux = Primary = 128; unless otherwise specified. (Continued)

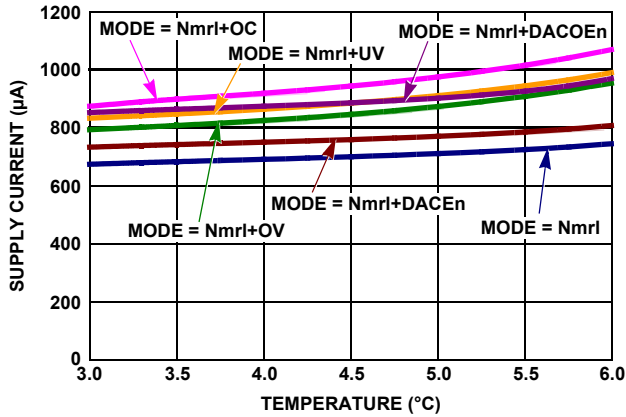

FIGURE 57. SUPPLY CURRENT vs SUPPLY VOLTAGE

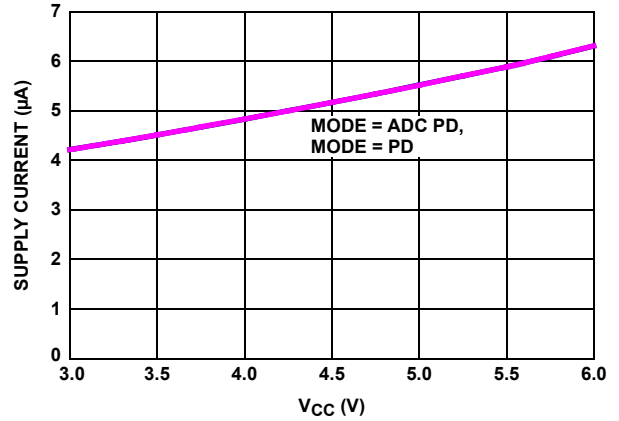

FIGURE 58. SUPPLY CURRENT vs SUPPLY VOLTAGE (POWER-DOWN MODES)

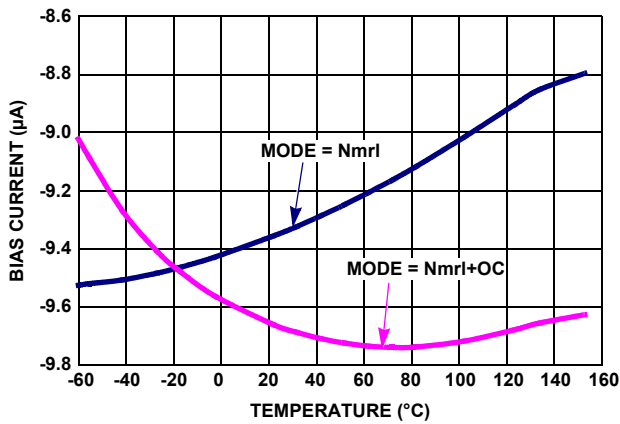

FIGURE 59. PRIMARY  $V_{SHUNT}$  BIAS CURRENT vs TEMPERATURE

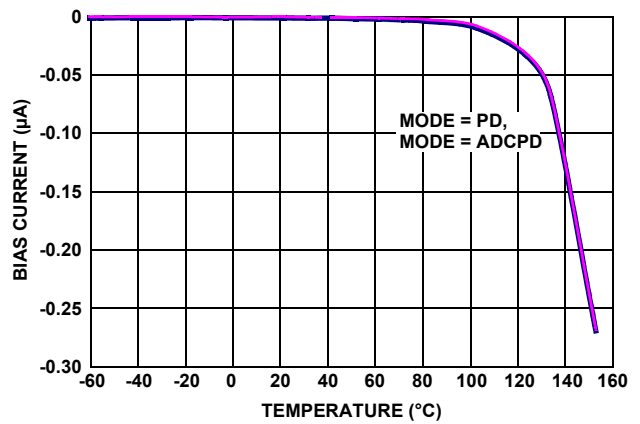

FIGURE 60. PRIMARY  $V_{SHUNT}$  BIAS CURRENT vs TEMPERATURE (POWER-DOWN MODE)

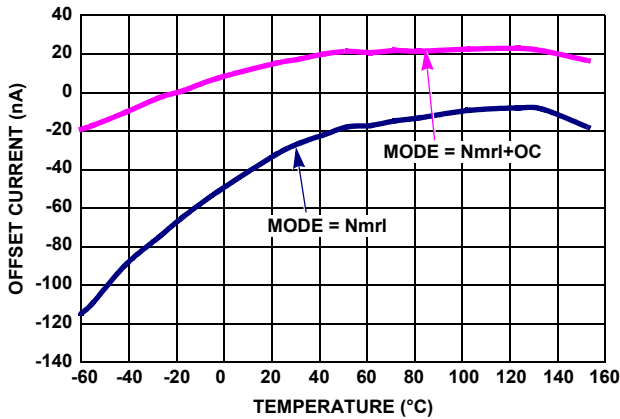

FIGURE 61. PRIMARY  $V_{SHUNT}$  BIAS CURRENT OFFSET vs TEMPERATURE

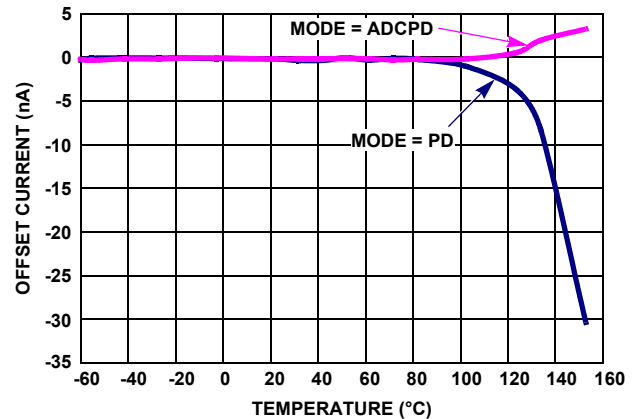

FIGURE 62. PRIMARY  $V_{SHUNT}$  BIAS CURRENT OFFSET vs TEMPERATURE (POWER-DOWN MODE)

# Typical Performance Curves

$T_A = +25^\circ\text{C}$ ,  $V_{CC} = 3.3\text{V}$ ,  $V_{INP} = V_{BUS} = 12\text{V}$ ,  $AUXP = AUXV = 3\text{V}$ ,  
 $V_{SHUNT} = VAUXSHUNT = 80\text{mV}$ , Conversion Time: Aux = Primary = 2.05ms, Internal AVG Aux = Primary = 128; unless otherwise specified. (Continued)

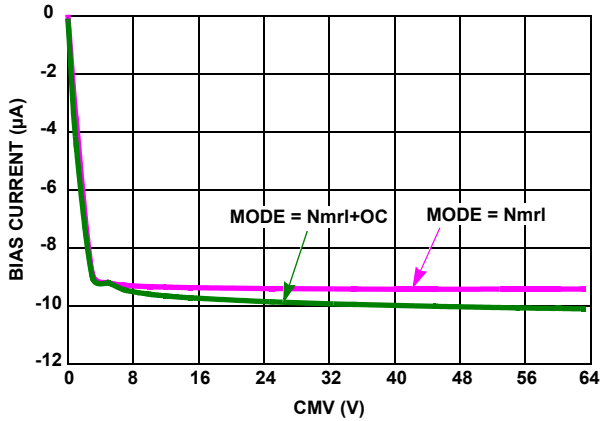

FIGURE 63. PRIMARY  $V_{SHUNT}$  BIAS CURRENT vs COMMON-MODE VOLTAGE

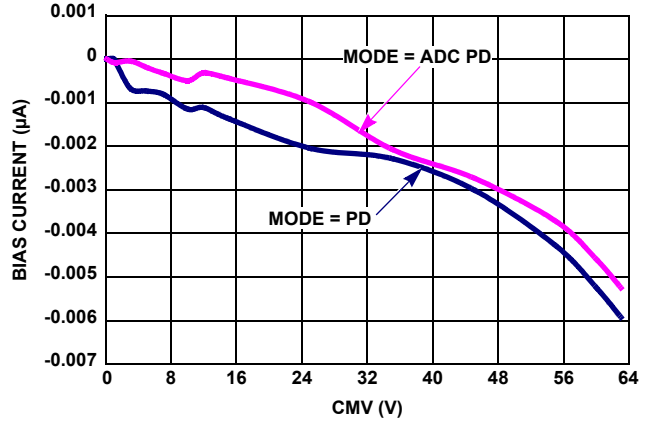

FIGURE 64. PRIMARY  $V_{SHUNT}$  BIAS CURRENT vs COMMON-MODE VOLTAGE (POWER-DOWN MODES)

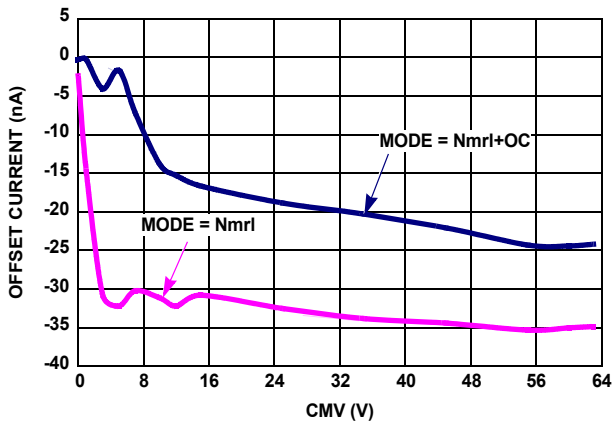

FIGURE 65. PRIMARY  $V_{SHUNT}$  OFFSET CURRENT vs COMMON-MODE VOLTAGE

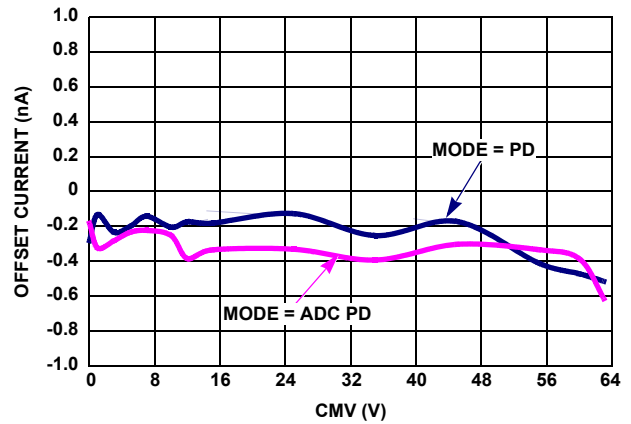

FIGURE 66. PRIMARY  $V_{SHUNT}$  OFFSET CURRENT vs COMMON-MODE VOLTAGE (POWER-DOWN MODES)

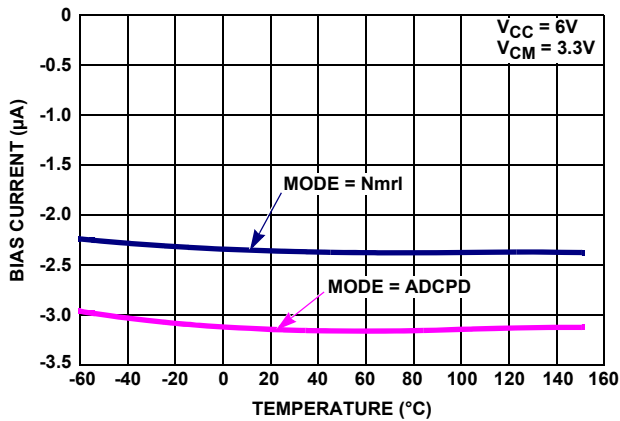

FIGURE 67. AUXILIARY  $V_{SHUNT}$  BIAS CURRENT vs TEMPERATURE

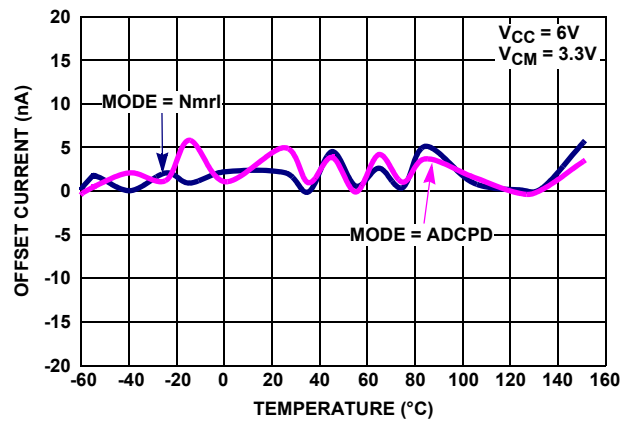

FIGURE 68. AUXILIARY  $V_{SHUNT}$  BIAS CURRENT OFFSET vs TEMPERATURE

# Typical Performance Curves

$T_A = +25^\circ\text{C}$ ,  $V_{CC} = 3.3\text{V}$ ,  $V_{INP} = V_{BUS} = 12\text{V}$ ,  $AUXP = AUXV = 3\text{V}$ ,  
 $V_{SHUNT} = V_{AUXSHUNT} = 80\text{mV}$ , Conversion Time: Aux = Primary = 2.05ms, Internal AVG Aux = Primary = 128; unless otherwise specified. (Continued)

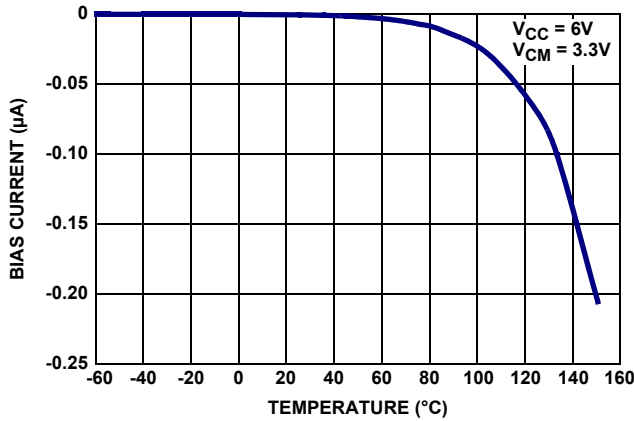

FIGURE 69. AUXILIARY  $V_{SHUNT}$  POWER-DOWN BIAS CURRENT vs TEMPERATURE

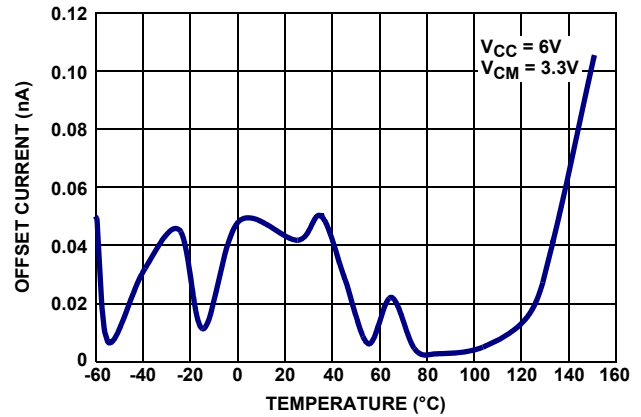

FIGURE 70. AUXILIARY  $V_{SHUNT}$  POWER-DOWN BIAS CURRENT OFFSET vs TEMPERATURE

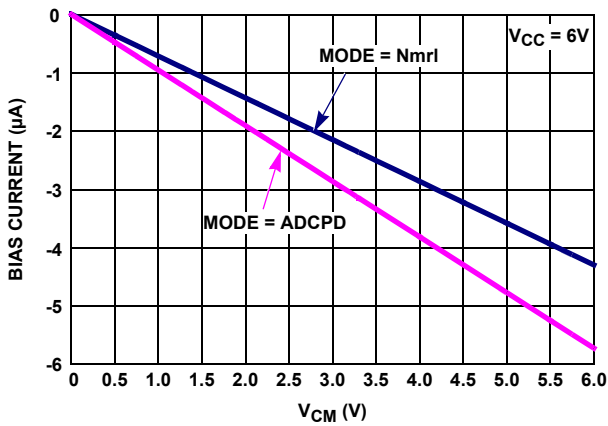

FIGURE 71. AUXILIARY  $V_{SHUNT}$  BIAS CURRENT vs COMMON-MODE VOLTAGE

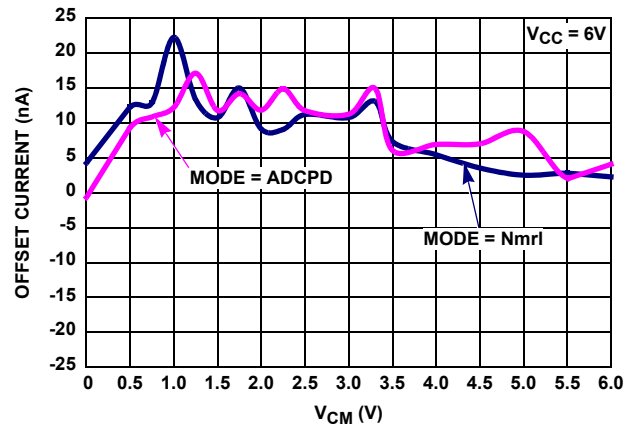

FIGURE 72. AUXILIARY  $V_{SHUNT}$  BIAS CURRENT OFFSET vs COMMON-MODE VOLTAGE

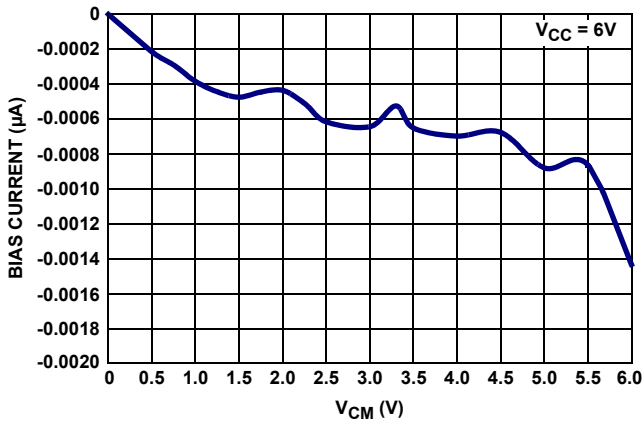

FIGURE 73. AUXILIARY  $V_{SHUNT}$  POWER-DOWN BIAS CURRENT vs COMMON-MODE VOLTAGE

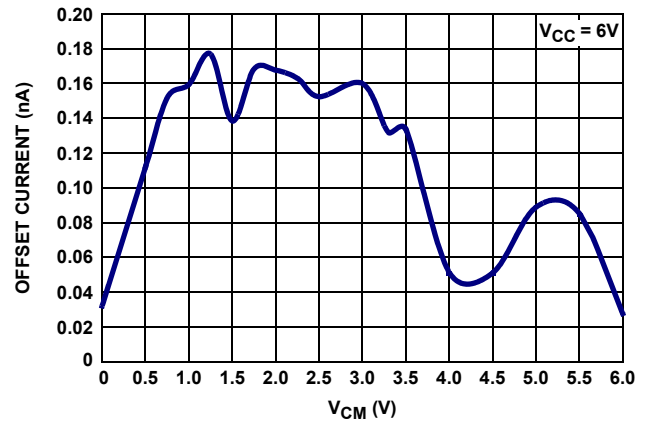

FIGURE 74. AUXILIARY  $V_{SHUNT}$  POWER-DOWN BIAS CURRENT OFFSET vs COMMON-MODE VOLTAGE

# Typical Performance Curves

$T_A = +25^\circ\text{C}$ ,  $V_{CC} = 3.3\text{V}$ ,  $V_{INP} = V_{BUS} = 12\text{V}$ ,  $AUXP = AUXV = 3\text{V}$ ,  
 $V_{SHUNT} = V_{AUXSHUNT} = 80\text{mV}$ , Conversion Time: Aux = Primary = 2.05ms, Internal AVG Aux = Primary = 128; unless otherwise specified. (Continued)

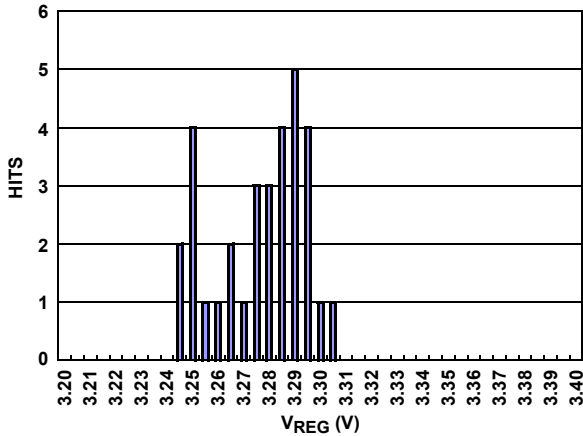

FIGURE 75.  $V_{REG}$  OUTPUT VOLTAGE DISTRIBUTION

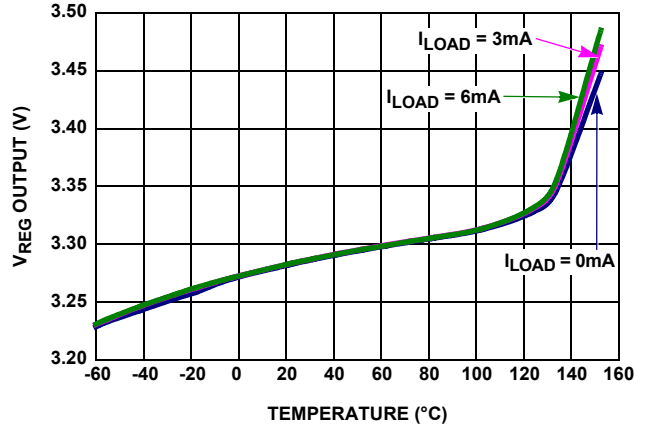

FIGURE 76.  $V_{REG}$  OUTPUT vs TEMPERATURE

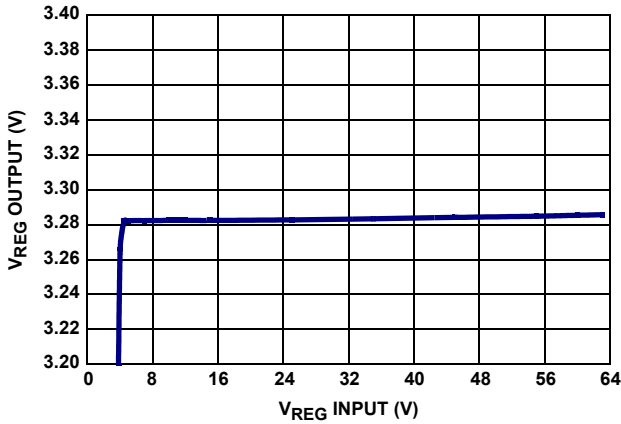

FIGURE 77.  $V_{REG}$  OUTPUT vs INPUT VOLTAGE

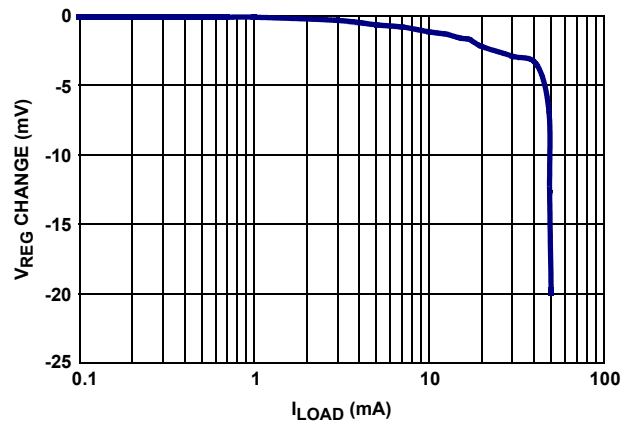

FIGURE 78.  $V_{REG}$  OUTPUT vs CURRENT LOAD

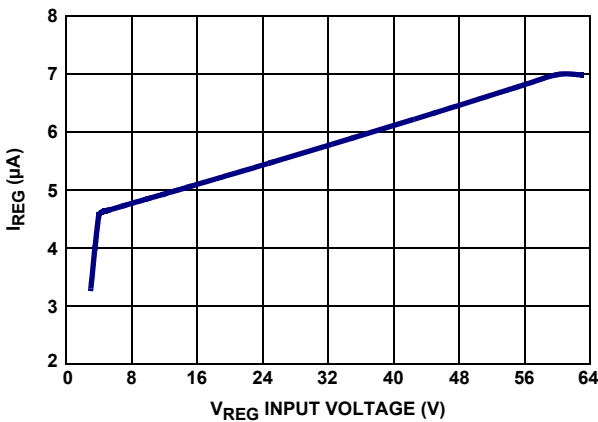

FIGURE 79.  $V_{REG}$  INPUT CURRENT vs INPUT VOLTAGE

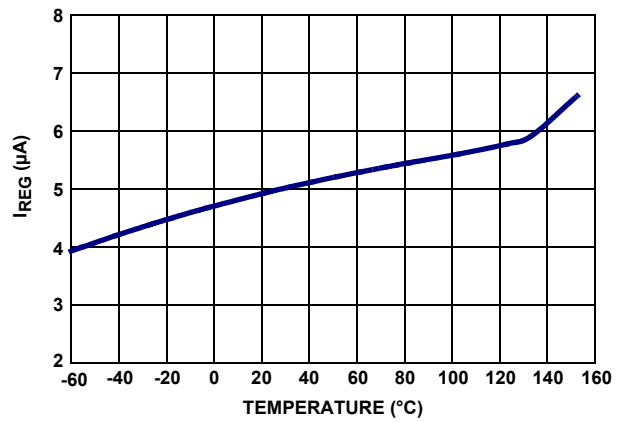

FIGURE 80.  $V_{REG}$  INPUT CURRENT vs TEMPERATURE



# Typical Performance Curves

$T_A = +25^\circ\text{C}$ ,  $V_{CC} = 3.3\text{V}$ ,  $V_{INP} = V_{BUS} = 12\text{V}$ ,  $AUXP = AUXV = 3\text{V}$ ,  
 $V_{SHUNT} = V_{AUXSHUNT} = 80\text{mV}$ , Conversion Time: Aux = Primary = 2.05ms, Internal AVG Aux = Primary = 128; unless otherwise specified. (Continued)

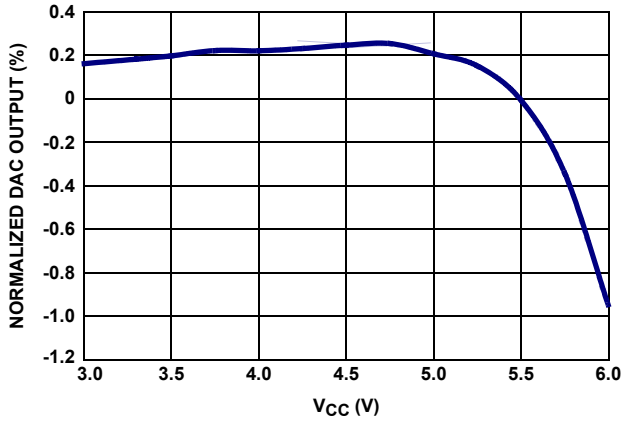

FIGURE 81. MARGIN DAC vs  $V_{CC}$

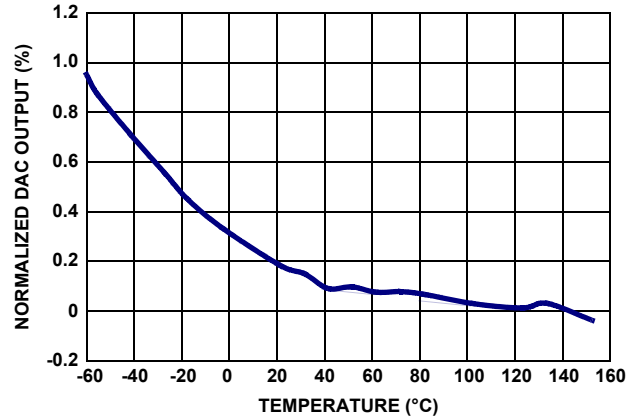

FIGURE 82. NORMALIZED DAC OUTPUT vs TEMPERATURE

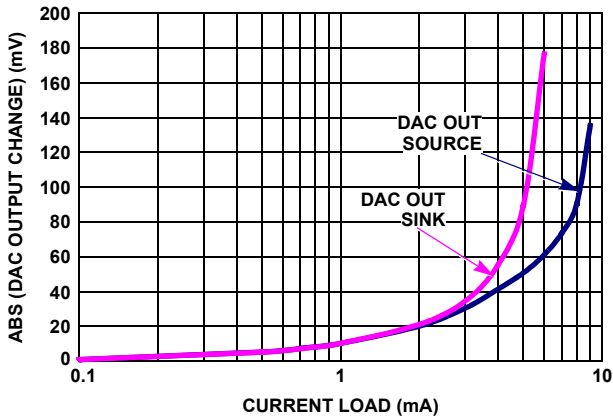

FIGURE 83. MARGIN DAC vs CURRENT LOAD

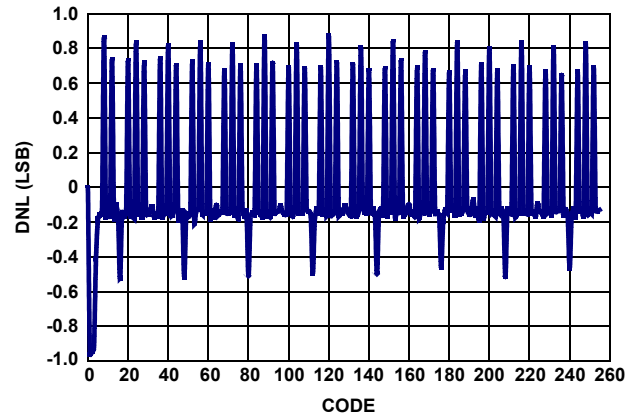

FIGURE 84. MARGIN DAC DNL

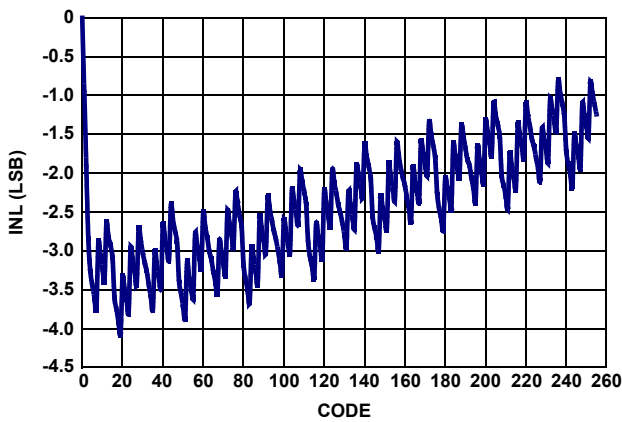

FIGURE 85. MARGIN DAC INL PER CODE

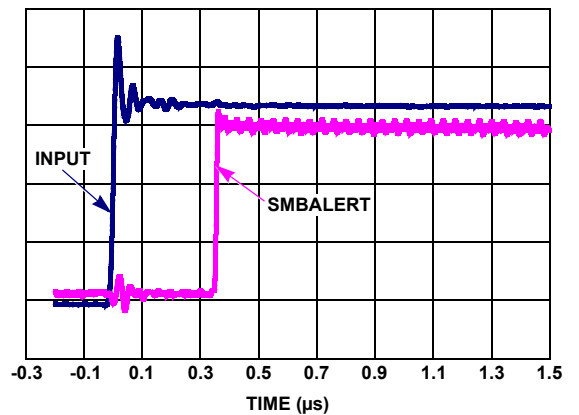

FIGURE 86. O.V OR UV OR OC ALERT RESPONSE TIME

# Typical Performance Curves

$T_A = +25^\circ\text{C}$ ,  $V_{CC} = 3.3\text{V}$ ,  $V_{INP} = V_{BUS} = 12\text{V}$ ,  $AUXP = AUXV = 3\text{V}$ ,  
 $V_{SHUNT} = VAUXSHUNT = 80\text{mV}$ , Conversion Time: Aux = Primary = 2.05ms, Internal AVG Aux = Primary = 128; unless otherwise specified. (Continued)

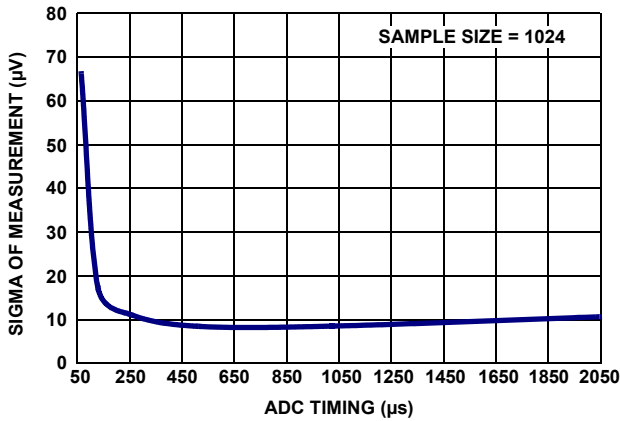

FIGURE 87. PRIMARY SHUNT STABILITY: STDEV vs ACQUISITION TIME

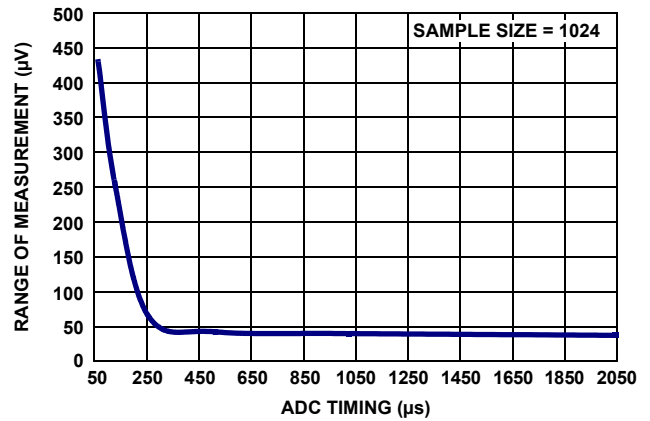

FIGURE 88. PRIMARY SHUNT STABILITY: RANGE vs ACQUISITION TIME

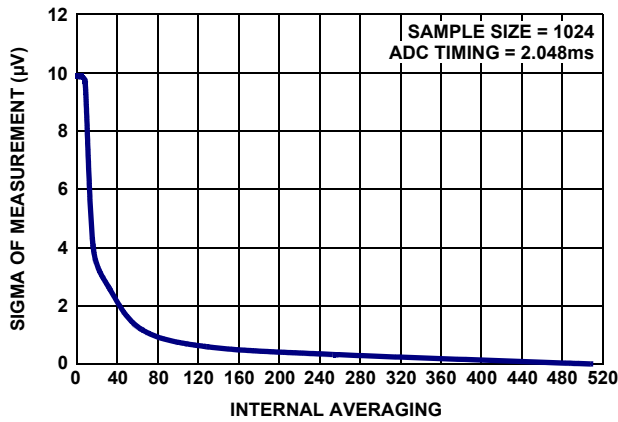

FIGURE 89. PRIMARY SHUNT STABILITY: STDEV vs INTERNAL AVERAGING

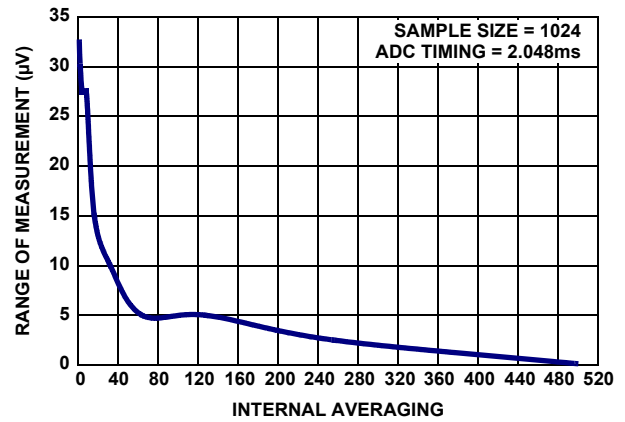

FIGURE 90. PRIMARY SHUNT STABILITY: RANGE vs INTERNAL AVERAGING

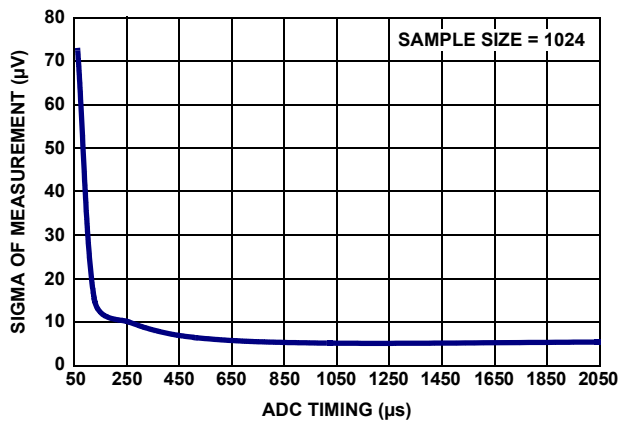

FIGURE 91. AUXILIARY SHUNT STABILITY: STDEV vs ACQUISITION TIME

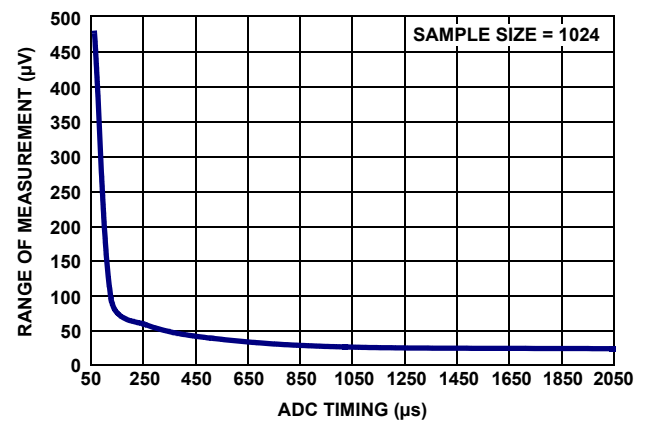

FIGURE 92. AUXILIARY SHUNT STABILITY: RANGE vs ACQUISITION TIME

## Typical Performance Curves

$T_A = +25^\circ\text{C}$ ,  $V_{CC} = 3.3\text{V}$ ,  $V_{INP} = V_{BUS} = 12\text{V}$ ,  $AUXP = AUXV = 3\text{V}$ ,  
 $V_{SHUNT} = V_{AUXSHUNT} = 80\text{mV}$ , Conversion Time: Aux = Primary = 2.05ms, Internal AVG Aux = Primary = 128; unless otherwise specified. (Continued)

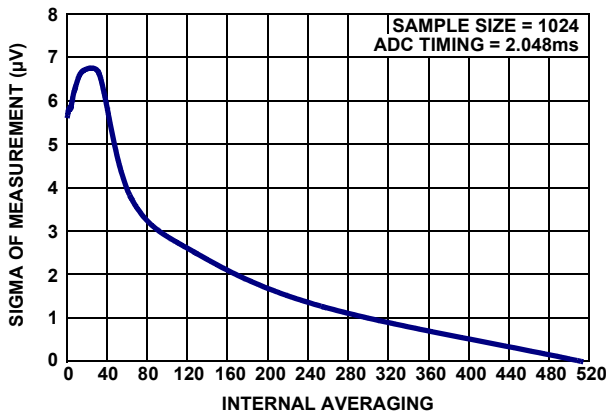

FIGURE 93. AUXILIARY SHUNT STABILITY: STDEV vs INTERNAL AVERAGING

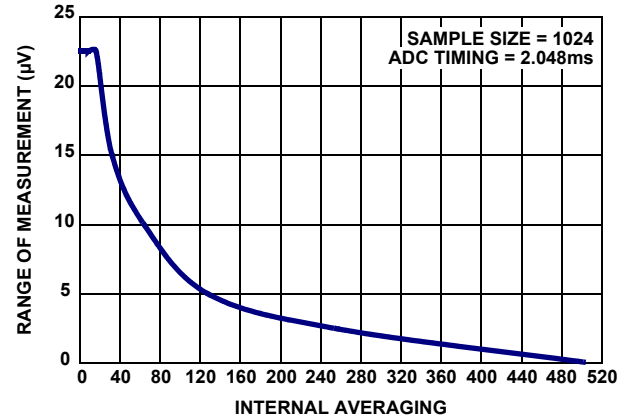

FIGURE 94. AUXILIARY SHUNT STABILITY: RANGE vs INTERNAL AVERAGING

## Overview

The ISL28023 is a digital current, voltage and power monitoring device for high and low-side power monitoring in positive and negative voltage applications.

The Digital Power Monitor (DPM) requires an external shunt resistor to enable current measurements. The shunt resistor translates the bus current to a voltage. The DPM measures the voltage across the shunt resistors and reports the measured value out digitally via an I<sup>2</sup>C interface. A register within the DPM is reserved to store the value of the shunt resistor. The stored current sense resistor value allows the DPM to output a current value to an external digital device.

The ISL28023 has two channels, which allow the user to monitor the voltage, current and power on two power supply rails. The two channels for the DPM consist of a primary channel and an auxiliary channel. The primary channel will allow and measure voltages from 0V to 60V or from 0V to 16.384V, depending on the option of the ISL28023. The auxiliary channel can tolerate and measure voltage from 0V to  $V_{CC}$ .

The ISL28023 has continuous fault detection for the primary channel. The DPM can be configured to set an alert in the instance of an overvoltage, undervoltage and/or overcurrent event. The response time of the alert is 500ns from the event. The ISL28023 has a temperature sensor with fault detection.

An 8-bit margin DAC, controllable through I<sup>2</sup>C communication, is incorporated into the DPM. The voltage margining feature allows for the adjustment of the regulated voltage to the load. The margin DAC can help in proving the load robustness versus the applied supply voltage.

The ISL28023 offers a 3.3V voltage regulator that can be used to power the chip in addition to low power peripheral circuitry. The DPM has an I<sup>2</sup>C power pin that allows the I<sup>2</sup>C master to set the digital communication supply voltage to the chip. The operating supply voltage for the DPM ranges from 3V to 5.5V. The device will accept I<sup>2</sup>C supply voltages between 1.2V and 5.5V.

The ISL28023 accepts SMBus protocols up to 3.4MHz. The device is PMBus compliant up to 400MHz. The device has Packet Error Code (PEC) functionality. The PEC protocol uses an 8-bit cyclic redundancy check (CRC-8) represented by the polynomial  $x^8+x^2+x^1+1$ . The ISL28023 can be configured for up to 55 unique slave addresses using 3 address select bits. The large amount of addressing allows 55 parts to communicate on a single I<sup>2</sup>C bus. It also gives the designer the flexibility to select a unique address when another slave address conflicts with the DPM on the same I<sup>2</sup>C bus.

## Pin Descriptions

### VBUS

VBUS is the power bus voltage input pin. The pin should be connected to the desired power supply bus to be monitored. The voltage range for the pin is from 0V to 60V or 0V to 16V depending on the ISL28023 version.

### VINP

VINP is the shunt voltage monitor positive input pin. The pin connects to the most positive voltage of the current shunt resistor. The voltage range for the pin is from 0V to 60V or 0V to 16V depending on the ISL28023 version. The maximum measurable voltage differential between VINP and VINM is 80mV.

### VINM

VINM is the shunt voltage monitor negative input pin. The pin connects to the most negative voltage of the current shunt resistor. The voltage range for the pin is from 0V to 60V or 0V to 16V depending on the ISL28023 version. The maximum measurable voltage differential between VINP and VINM is 80mV.

### AUXV

AUXV is the power bus voltage input pin. The pin should be connected to the desired power supply bus to be monitored. The voltage range for the pin is from 0V to  $V_{CC}$ .

**AUXP**

AUXP is the auxiliary shunt voltage monitor positive input pin. The pin connects to the most positive voltage of the auxiliary current shunt resistor. The voltage range for the pin is from 0V to V<sub>CC</sub>. The maximum measurable voltage differential between AUXP and AUXM is 80mV.

**AUXM**

AUXM is the auxiliary shunt voltage monitor negative input pin. The pin connects to the most negative voltage of the auxiliary current shunt resistor. The voltage range for the pin is from 0V to V<sub>CC</sub>. The maximum measurable voltage differential between AUXP and AUXM is 80mV.

**VCC**

VCC is the positive supply voltage pin. VCC is an analog power pin. VCC supplies power to the device. The allowable voltage range is from 3V to 5.5V.

**I2CVCC**

I2CVCC is the positive supply voltage pin. I2CVCC is an analog power pin. I2CVCC supplies power to the digital communication circuitry, I<sup>2</sup>C, of the device. The allowable voltage range is from 1.2V to 5.5V.

**GND**

Device ground. For single supply systems, the pin connects to system ground. For dual supply systems, the pin connects to the negative voltage supply in the system.

**VREG\_IN**

VREG\_IN is the voltage regulator input pin. The operable input voltage range to the regulator is 4.5V to 60V.

**VREG\_OUT**

VREG\_OUT is the voltage regulator output pin. The regulated output voltage of 3.3V is sourced from the VREG\_OUT pin.

**DAC\_OUT**

DAC\_OUT is the margin DAC output pin. The output of the DAC voltage ranges from 0V to 2.4V. The voltage DAC is controlled through internal registers.

**ADDRESS PINS (A0, A1, A2)**

A0, A1 and A2 are address selectable pins. The address pins are I<sup>2</sup>C/SMBus slave address select pins that are multilogic programmable for a total of 55 different address combinations.

There are four selectable levels for the address pins, I2CVCC, GND, SCL/SMBCLK, and SDA/SMBDAT. See [Table 49 on page 45](#) for more details in setting the slave address of the device.

**SDA/SMBDAT**

SDA/SMBDAT is the serial data input/output pin. SDA/SMBDAT is a bidirectional pin used to transfer data to and from the device. The pin is an open-drain output and may be wired with other open-drain/collector outputs. The input buffer is always active (not gated). The open-drain output requires a pull-up resistor for proper functionality. The pull-up resistor should be connected to I2CVCC of the device.

**SCL/SMBCLK**

SCL/SMBCLK is the serial clock input pin. The SCL/SMBCLK input is responsible for clocking in all data to and from the device. The input buffer on the pin is always active (not gated). The input pin requires a pull-up resistor to I2CVCC of the device.

**SMBALERT PINS (SMBALERT1, SMBALERT2)**

The SMBALERT pins are output pins. The SMBALERT1 is an open-drain output and requires a pull-up resistor to a power supply up to 24V. The SMBALERT2 has a push/pull output stage. The SMBALERT pins are fault acknowledgment pins. The pin can be connected to peripheral circuitry to halt operations when a fault event occurs.

**EXT\_CLK**

EXT\_CLK is the external clock pin. EXT\_CLK is an input pin. The pin provides a connection to the system clock. The system clock is connected to the ADC. The acquisitions rate of the ADC can be varied through the EXT\_CLK pin. The pin functionality is set through a control register bit.

TABLE 2. ISL28023 REGISTER DESCRIPTIONS

REGISTER ADDRESS (HEX)	REGISTER NAME	FUNCTION	POWER ON RESET VALUE (HEX)	NUMBER OF BYTES	ACCESS TYPE	PAGE
<b>IC DEVICE DETAILS</b>						
19	CAPABILITY	PMBus Supportability	80	1	R	<a href="#">31</a>
20	VOUT MODE	Describes the ADC Read Back Format	40	1	R	<a href="#">31</a>
99	PMBUS REV	PMBus Revision	22	1	R	<a href="#">31</a>
AD	IC DEVICE ID	Device ID	0849534C3238303233	8	R	<a href="#">31</a>
AE	IC DEVICE REV	Device Revision and Silicon Version	000002	3	R	<a href="#">31</a>
<b>GLOBAL IC CONTROLS</b>						
12	RESTORE DEFAULT LL	Soft Reset	N/A	0	W	<a href="#">32</a>
01	OPERATION	Turns the Device On and Off	80	1	R/W	<a href="#">32</a>

TABLE 2. ISL28023 REGISTER DESCRIPTIONS (Continued)

REGISTER ADDRESS (HEX)	REGISTER NAME	FUNCTION	POWER ON RESET VALUE (HEX)	NUMBER OF BYTES	ACCESS TYPE	PAGE
<b>PRIMARY AND AUXILIARY CHANNEL CONTROLS</b>						
D2	SET DPM MODE	Configures the ISL28023	0A	1	R/W	<a href="#">32</a>
D3	DPM CONV STATUS	Indicates the Status of a Conversion	N/A	1	R	<a href="#">32</a>
D4	CONFIG ICHANNEL	Shunt Inputs (Primary and Auxiliary) Configuration	0387	2	R/W	<a href="#">33</a>
38	IOUT CAL GAIN	Calibration that Enables Primary Current Measurements	0000	2	R/W	<a href="#">33</a>
D5	CONFIG VCHANNEL	Bus Inputs (Primary and Auxiliary) Configuration	0387	2	R/W	<a href="#">34</a>
D7	CONFIG PEAK DET	Enables Primary Channel Current Peak Detector	00	1	R/W	<a href="#">34</a>
E2	CONFIG EXCITATION	Enables Temp Measurements on the Auxiliary Shunt Input	00	1	R/W	<a href="#">34</a>
<b>MEASUREMENT REGISTERS</b>						
D6	READ VSHUNT OUT	Primary Shunt Measurement Value	0000	2	R	<a href="#">35</a>
8B	READ VOUT	Primary Bus Measurement Value	0000	2	R	<a href="#">35</a>
8C	READ IOUT	Primary Current Measurement Value	0000	2	R	<a href="#">35</a>
D8	READ PEAK MIN IOUT	Primary Current Maximum Measurement Value	7FFF	2	R	<a href="#">35</a>
D9	READ PEAK MAX IOUT	Primary Current Minimum Measurement Value	8001	2	R	<a href="#">35</a>
96	READ POUT	Primary Power Measurement Value	0000	2	R	<a href="#">35</a>
E0	READ VSHUNT OUT AUX	Axillary Shunt Measurement Value	0000	2	R	<a href="#">36</a>
E1	READ VOUT AUX	Auxiliary Bus Measurement Value	0000	2	R	<a href="#">36</a>
8D	READ TEMPERATURE 1	Internal/External Temperature Measurement Value	0000	2	R	<a href="#">36</a>
<b>THRESHOLD DETECTORS</b>						
DA	VOUT OV THRESHOLD SET	Overvoltage/Over-temperature Threshold Configuration	003F	2	R/W	<a href="#">36</a>
DB	VOUT UV THRESHOLD SET	Undervoltage Threshold Configuration	00	1	R/W	<a href="#">37</a>
DC	IOUT OC THRESHOLD SET	Overcurrent Threshold Configuration	003F	2	R/W	<a href="#">37</a>
<b>SMB ALERT</b>						
DD	CONFIG INTR	Configure the Behavior of the Interrupts	0000	2	R/W	<a href="#">39</a>
DE	FORCE FEEDTHR ALERT	Configure the Path of the Interrupt Signal	00	1	R/W	<a href="#">39</a>
1B	SMBALERT MASK	Alert Mask for the SMBALERT1 Pin	N/A	2	R/W	<a href="#">41</a>
DF	SMBALERT2 MASK	Alert Mask for the SMBALERT2 Pin	N/A	1	R/W	<a href="#">41</a>
03	CLEAR FAULTS	Clears All Faults	N/A	0	W	<a href="#">40</a>
7A	STATUS VOUT	Alert Bits related to the Primary Bus	00	1	R/W	<a href="#">40</a>
7B	STATUS IOUT	Alert Bit related to the Primary Shunt	00	1	R/W	<a href="#">40</a>
7D	STATUS TEMPERATURE	Alert Bit related to Temperature	00	1	R/W	<a href="#">40</a>
7E	STATUS CML	Alert Bits related to Communication Errors	00	1	R/W	<a href="#">40</a>
78	STATUS BYTE	Alert Bits related to Temperature and Device Status	00	1	R/W	<a href="#">41</a>
79	STATUS WORD	Alert Bits related to all Primary Inputs	0000	2	R/W	<a href="#">41</a>
<b>VOLTAGE MARGIN</b>						
E4	CONFIG VOL MARGIN	Configures the Margin DAC	00	1	R/W	<a href="#">43</a>
E3	SET VOL MARGIN	Value to Load into the Margin DAC	80	1	R/W	<a href="#">43</a>
<b>EXTERNAL CLOCK CONTROL</b>						
E5	CONFIG EXT CLK	Configures External Clock; Enable/Disable SMBALERT2	00	1	R/W	<a href="#">42</a>

## Communication Protocol

The DPM chip communicates with the host using PMBus commands. PMBus command structure is an industry SMBus standard for communicating with power supplies and converters. All communications to and from the chip use the SMBCLK and SMBDAT to communicate to the DPM master. The SMB pins require a pull-up resistor to enable proper operation. The default logic state of the communication pins are high when the bus is in an idle state.

The SMBus standard is a variant of the I<sup>2</sup>C communication standard with minor differences with timing and DC parameters. SMBus supports Packet Error Corrections (PEC) for data integrity certainty. The PMBus is the standardization of the SMBus register designation. The standardization is specific to power and converter devices.

The DPM employs the following command structures from the I<sup>2</sup>C communication standard;

1. Send Byte
2. Write Byte/Word
3. Read Byte/Word
4. Read Block
5. Write Block

### Packet Error Correction (PEC)

Packet Error Correction is often used in environments where data being transferred to and from the device can be compromised. Applications where the device is connected by way of a cable is common use of PEC. The cable's integrity may be compromised resulting in error transactions between the master and the device. The ISL28023 uses an 8-bit cyclic redundancy check (CRC-8). [Figure 95](#) is an example of a flow algorithm for CRC-8 protocol.

### Public Function crc8Decode(binStr As String) As Byte

*Declaration of variables*

Dim crc8(0 To 7) As Byte, index As Byte, dolInvert As Byte

*The input to the subroutine is a binary string consisting of the slave address, the register address and data inputted to or received from the part. Anything input into or received from the device is part of the binary string (binStr) to be calculated by this routine.*

*Clear the crc8 variable. This variable is used to return the PEC value.*

For index = 0 To UBound(crc8)

    crc8(index) = 0

Next index

index = 0

While index <> (Len(binStr))

    index = index + 1

*The If statement below reads the binary value of each bit in the binary string (binStr).*

    If Mid(binStr, index, 1) = "1" Then

        dolInvert = 1 Xor crc8(7)

    Else

        dolInvert = 0 Xor crc8(7)

    End If

    crc8(7) = crc8(6)

    crc8(6) = crc8(5)

    crc8(5) = crc8(4)

    crc8(4) = crc8(3)

    crc8(3) = crc8(2)

    crc8(2) = crc8(1) Xor dolInvert

    crc8(1) = crc8(0) Xor dolInvert

    crc8(0) = dolInvert

Wend

    crc8Decode = 0

For index = 0 To 7 *This assembles the crc8 value in byte form.*

    crc8Decode = crc8(index) \* 2 ^ index + crc8Decode

Next index *'crc8Decode is returned from this routine.*

End Function

FIGURE 95. AN ALGORITHM TO CALCULATE A CRC8 (PEC) BYTE VALUE.

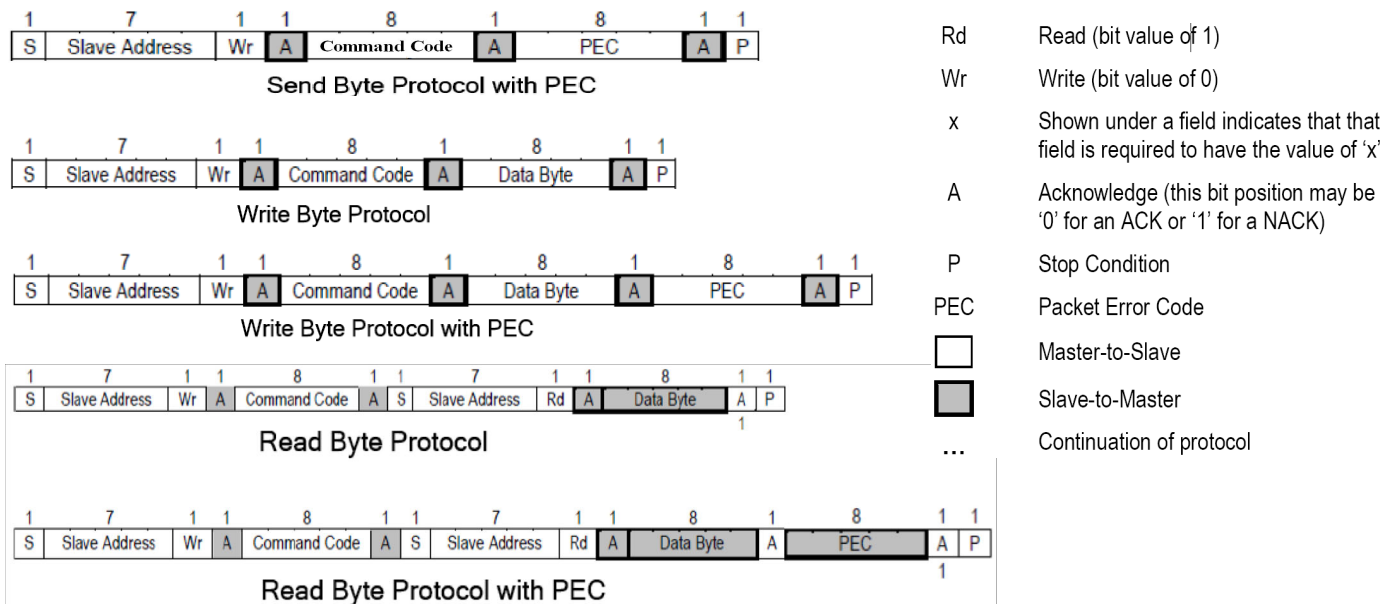

FIGURE 96. READ/WRITE SMBUS PROTOCOLS WITH AND WITHOUT PEC. DIAGRAMS COPIED FROM A SMBUS SPECIFICATION DOCUMENT. THE DOCUMENT CAN BE UPLOADED AT <http://smbus.org/specs/>

## IC Device Details

### 0X19 CAPABILITY (R)

The capability register is a read only byte register that describes the supporting communication standard by the DPM chip.

TABLE 3. 0x19 CAPABILITY REGISTER DEFINITION

BIT NUMBER	D7	D[6:5]	D4	D[3:0]
Bit Name	PEC	Max Bus Speed	SMB Alert Support	N/A
Default Value	1	01	1	0000

The DPM chip supports Packet Error Correction (PEC) protocol. The maximum PMBus bus speed that the DPM supports is 400kHz. The DPM supports a higher speed option that is not compliant to the PMBus standard. The higher speed option is discussed later in the datasheet. The DPM chip has SMB alert pins which, supports SMB alert commands.

### 0X20 V<sub>OUT</sub> MODE (R)

The V<sub>OUT</sub> Mode register is a readable byte register that describes the method to calculate read back values from the DPM such as voltage, current, power and temperature. The value for the register is 0x40. The register value represents a direct data read back format. For unsigned registers such as V<sub>BUS</sub>, the register value is calculated using Equation 1.

$$\text{Register Value} = \sum_{n=0}^{15} \left( \text{Bit\_Val}_n \cdot 2^n \right) \quad (\text{EQ. 1})$$

Otherwise, Equation 2 is used for signed readings.

$$\text{Register Value} = \sum_{n=0}^{14} \left( \text{Bit\_Val}_n \cdot 2^n \right) - \left( \text{Bit\_Val}_{15} \cdot 2^{15} \right) \quad (\text{EQ. 2})$$

n is the bit position within the register value. Bit\_Val is the value of the bit either 1 or 0.

### 0X99 PMBUS REV (R)

The PMBUS Rev register is a readable byte register that describes the PMBUS revision that the DPM is compliant to.

TABLE 4. 0x99 PMBUS REV REGISTER DEFINITION

BIT NUMBER	D[7:4]	D[3:0]
Bit Name	PMBUS Rev Part I	PMBUS Rev Part II
Default Value	0010	0010

PMBUS Rev part 1 is a PMBus specification pertaining to electrical transactions and hardware interface. PMBUS Rev part 2 specification pertains to the command calls used to address the DPM.

A nibble of 0000 translates to revision 1.0 of either PMBUS revision. A nibble of 0001 equals 1.1 of either PMBUS revision.

### 0XAD IC DEVICE ID (BR)

The IC Device ID is a block readable register that reports the device product name being addressed. The product ID that is stored in the register is “ISL28023”. Each character is stored as an ASCII number. A 0x30 equals ASCII “0”. A 0x49 translates to an ASCII “I”. Figure 97 illustrates the convention for performing a block read.

### 0XAE IC\_DEVICE\_REV (BR)

The IC Device Revision is a block readable register that reports back the revision number of the silicon and the version of the silicon. The register is 3 bytes in length.

TABLE 5. 0xAE IC DEVICE REV REGISTER DEFINITION

BIT NUMBER	D[23:12]	D[11]	D[10:0]
Bit Name	N/A	Silicon Version	Silicon Revision
Default Value	0000 0011 0000	1	000 0000 0010

### SILICON VERSION D[11]

Data Bit11 of the IC Revision register reports the version of the silicon.

TABLE 6. D[11] SILICON VERSION BIT DEFINED

D16	STATUS
0	60V
1	12V

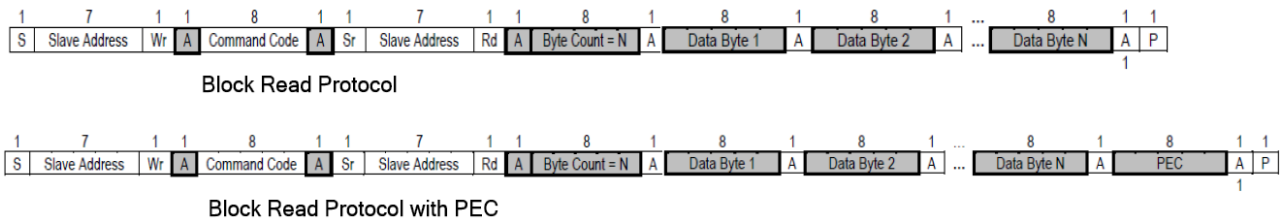

FIGURE 97. BLOCK READ SMBUS PROTOCOLS WITH AND WITHOUT PEC. DIAGRAMS COPIED FROM SMBUS SPECIFICATION DOCUMENT. THE DOCUMENT CAN BE UPLOADED AT <http://smbus.org/specs/>

## Global IC Controls

### 0X12 RESET DEFAULT ALL (S)

The Restore Default All register is a send byte command that restores all registers to the default state defined in [Table 2](#).

### 0X01 OPERATION (R/W)

The Operation register is a read/writable byte register that controls the overall power up state of the chip. Data Bit 7 of the register configures the power status of the chip. The power status is defined in [Table 7](#). Yellow shading in the table is the default setting of the bit at power-up.

TABLE 7. 0x01 OPERATION REGISTER BIT7 DEFINED

D7	STATUS
0	Power-Down
1	Normal Operation

## Primary and Auxiliary Channel Controls

### 0XD2 SET DPM MODE (R/W)

The Set DPM Mode is a read/writable byte register that controls the data acquisition behavior of the chip.

TABLE 8. 0xD2 SET DPM MODE REGISTER DEFINITION

BIT NUMBER	D[7]	D6	D[5]	D[4]	D[3]	D[2:0]
Bit Name	N/A	ADC Enable	ADC State	Post Trigger State	ADC Mode Type	Operating Mode
Default Value	0	0	0	0	1	010

### ADC ENABLE D[6]

Data Bit 6 of the Set DPM Mode register controls the ADC power state within the DPM chip. At power-up, the ADC is powered up and is available to take data.

TABLE 9. 0xD2 SET DPM MODE REGISTER BIT6 DEFINED

D6	ADC PD
0	Normal Mode
1	ADC Powered Down

### ADC STATE D[5]

Data Bit5 of the Set DPM Mode register controls the ADC state. The idle state of the ADC does not acquire data from any input of the DPM. Normal operating mode has the ADC acquiring data in a systematic way.

TABLE 10. 0xD2 SET DPM MODE REGISTER BIT5 DEFINED

D5	ADC STATE
0	Normal State
1	ADC in Idle State

### POST TRIGGER STATE D[4]

Data Bit 4 of the Set DPM Mode register controls the post ADC state once an acquisition has been made in the trigger mode.

TABLE 11. 0xD2 SET DPM MODE REGISTER BIT4 DEFINED

D4	POST TRIGGER STATE
0	Idle Mode after a Trigger Measurement
1	PD Mode after Trigger Measurement

### ADC MODE TYPE D[3]

Data Bit 3 of the Set DPM Mode register controls the behavior of the ADC to either triggered or continuous. The continuous mode has the ADC continuously acquiring DAT in a systematic manor described by data Bits[2:0] in the set DPM mode register. The triggered mode instructs the ADC to make an acquisition described by data Bits[2:0]. The beginning of a triggered cycle starts once writing to the Set DPM Mode register commences. The trigger mode is useful for reading a single measurement per acquisition cycle.

TABLE 12. 0xD2 SET DPM MODE REGISTER BIT3 DEFINED

D3	ADC MODE TYPE
0	Trigger
1	Continuous

### OPERATING MODE D[2:0]

The Operating Mode bits of the Set DPM Mode register controls the state machine within the chip. The state machine globally controls the overall functionality of the chip. [Table 13](#) shows the various measurement states the chip can be configured to, as well as the mode bit definitions to achieve a desired measurement state. The shaded row is the default setting upon power-up.

TABLE 13. 0xD2 SET DPM MODE REGISTER BITS 2 TO 0 DEFINED

D[2:0]	MEASUREMENT INPUT
0	Primary Channel Shunt Voltage
1	Primary Channel V <sub>BUS</sub> Voltage
2	Primary Shunt and V <sub>BUS</sub> Voltages
3	Auxiliary Channel Shunt Voltage
4	Auxiliary Channel V <sub>BUS</sub> Voltage
5	Auxiliary Shunt and V <sub>BUS</sub> Voltages
6	Internal Temperature
7	All

### 0XD3 DPM CONVERSION STATUS (R)

The DPM Conversion Status register is a readable byte register that reports the status of a conversion when the DPM is programmed in the trigger mode.

TABLE 14. 0xD3 DPM CONVERSION STATUS REGISTER DEFINITION

BIT NUMBER	D[7:2]	D[1]	D[0]
Bit Name	N/A	CNVR	OVF
Default Value	0	0	0



**CNVR: CONVERSION READY D[1]**

The Conversion Ready bit indicates when the ADC has finished a conversion and has transferred the reading(s) to the appropriate register(s). The CNVR is only operable when the ADC state is set to trigger. The CNVR is in a low state when the conversion is in progress. When the CNVR bit transitions from a low state to a high state and remains at a high state, the conversion is complete. The CNVR initializes or reinitializes when writing to the Set DPM Mode register.

**OVF: MATH OVERFLOW FLAG D[0]**

The Math Overflow Flag (OVF) bit is set to indicate the current and power data being read from the DPM is overranged and meaningless.

**OXD4 CONFIGURE ICHANNEL (R/W)**

The Configure IChannel register is a read/writable word register that configures the ADC measurement acquisition settings for the primary and auxiliary voltage shunt inputs.

**TABLE 15. 0xD4 CONFIGURE ICHANNEL REGISTER DEFINITION**

BIT NUMBER	D[15:14]	D[13:10]	D[9:7]	D[6:3]	D[2:0]
Bit Name	N/A	Aux Shunt Sample AVG	Aux Shunt Conversion Time	Prim Shunt Sample AVG	Prim Shunt Conversion Time
Default Value	00	00 00	11 1	000 0	111

**SHUNT VOLTAGE CONVERSION TIME D[9:7], D[2:0]**

The Shunt Voltage Conversion Time bits set the acquisition speed of the ADC when measuring either the primary or auxiliary voltage shunt channels of the DPM. The primary and auxiliary V<sub>SHUNT</sub> channels have independent timing control bits allowing for the primary V<sub>SHUNT</sub> channel to have a unique acquisition time with respect to the auxiliary V<sub>SHUNT</sub> channel. [Table 16](#) is a list of the selectable V<sub>SHUNT</sub> ADC time settings. The shaded row indicates the default setting.

**TABLE 16. AUXILIARY/ PRIMARY V<sub>SHUNT</sub> CONVERSION TIMES DEFINED**

Config_Ichannel: D[9:7],D[2:0]			CONVERSION TIME
0	0	0	64μs
0	0	1	128μs
0	1	0	256μs
0	1	1	512μs
1	0	X	1.024ms
1	1	X	2.048ms

**SHUNT VOLTAGE SAMPLE AVERAGE D[13:10], D[6:3]**

The Shunt Voltage Sample Average bits set the number of averaging samples for a unique sampling time. The DPM will record all samples and output the average resultant to the respective V<sub>SHUNT</sub> register. The primary and auxiliary V<sub>SHUNT</sub> channels have independent average settings allowing for the primary V<sub>SHUNT</sub> channel to have a unique average setting with

respect to the auxiliary average setting. [Table 17](#) defines the list of selectable averages the DPM can be set to. The shaded row indicates the default setting.

**TABLE 17. AUXILIARY/ PRIMARY V<sub>SHUNT</sub> NUMBER OF SAMPLES TO AVERAGE DEFINED**

AVG[3:0]				CONVERTER AVERAGES
0	0	0	0	1
0	0	0	1	2
0	0	1	0	4
0	0	1	1	8
0	1	0	0	16
0	1	0	1	32
0	1	1	0	64
0	1	1	1	128
1	0	0	0	256
1	0	0	1	512
1	0	1	0	1024
1	0	1	1	2048
1	1	X	X	4096

**OX38 IOUT CALIBRATION GAIN (R/W)**

The IOUT Calibration Gain register is a read/writable word register that is used to calculate current and power measurements for the primary channel of the DPM. When the register is programmed, the DPM calculates the current and power based on the primary channels V<sub>BUS</sub> and V<sub>SHUNT</sub> measurements. The calculation resultant is stored in the READ\_IOUT and READ\_POOUT registers.

The calibration register value can be calculated as follows:

1. Calculate the full-scale current range that is desired. This can be calculated using [Equation 3](#).

$$\text{Current}_{FS} = \frac{V_{shunt_{FS}}}{R_{shunt}} \quad (\text{EQ. 3})$$

2. R<sub>SHUNT</sub> is the value of the shunt resistor. V<sub>shunt<sub>FS</sub></sub> is the full-scale range of the primary channel, which equals 80mV.
3. From the current full-scale range, the current LSB can be calculated using [Equation 4](#). Current full-scale is the outcome from [Equation 3](#). ADC<sub>res</sub> is the resolution of shunt voltage reading. The output of the ADC is a signed 15-bit binary number. Therefore, the ADC<sub>res</sub> value equals 2<sup>15</sup> or 32768.

$$\text{Current}_{LSB} = \frac{\text{Current}_{FS}}{\text{ADC}_{res}} \quad (\text{EQ. 4})$$

4. From [Equation 4](#), the calibration resistor value can be calculated using [Equation 5](#). The resolution of the math that is processed internally in the DPM is 2048 or 11 bits of resolution. The V<sub>SHUNT</sub> LSB is set to 2.5μV. [Equation 5](#) yields a 15-bit binary number that can be written to the calibration register. The calibration register format is represented in [Table 18](#).

$$\text{CalReg}_{\text{val}} = \text{integer} \left[ \frac{\text{Math}_{\text{res}} \cdot V_{\text{shunt\_LSB}}}{(\text{Current}_{\text{LSB}} \cdot R_{\text{shunt}})} \right]$$

$$\text{CalReg}_{\text{val}} = \text{integer} \left[ \frac{0.00512}{(\text{Current}_{\text{LSB}} \cdot R_{\text{shunt}})} \right] \quad (\text{EQ. 5})$$

**TABLE 18. 0x38 IOUT\_CAL\_GAIN DEFINITION**

BIT NUMBER	D[15]	D[14:0]
Bit Name	N/A	IOUT_CAL_GAIN
Default Value	0	000 0000 0000 0000

**0XD5 CONFIGURE VCHANNEL (R/W)**

The Configure Vchannel register is a read/writable word register that configures the ADC measurement acquisition settings for the primary and auxiliary voltage bus inputs.

**TABLE 19. 0xD5 CONFIGURE VCHANNEL REGISTER DEFINITION**

BIT NUMBER	D[15:14]	D[13:10]	D[9:7]	D[6:3]	D[2:0]
Bit Name	N/A	AuxV Sample AVG	AuxV Conversion Time	V <sub>BUS</sub> Sample AVG	V <sub>BUS</sub> Conversion Time
Default Value	00	00 00	11 1	000 0	111

The ADC configuration of the sampling average and conversion time settings for V<sub>BUS</sub> and AuxV channels have the same setting choices as the V<sub>SHUNT</sub> primary and auxiliary channels.

**0XD7 CONFIGURE PEAK DETECTOR (R/W)**

The Configure Peak Detector register is a read/writable byte register that toggles the minimum and maximum current tracking feature. A Peak Detect Enable bit setting of 1 enables the current peak detect feature of the DPM. The feature is discussed in more detail in [“0xD8 Read Peak Min I<sub>OUT</sub>\(R\)” on page 35](#).

**TABLE 20. 0xD7 CONFIGURE PEAK DETECTOR REGISTER DEFINITION**

BIT NUMBER	D[7:1]	D[0]
Bit Name	N/A	Peak Detect En
Default Value	0000 000	0

**0XE2 CONFIGURE EXCITATION (R/W)**

The Configure Excitation register is a read/writable byte register that changes the measurement functionality of the auxiliary V<sub>SHUNT</sub> input.

**TABLE 21. 0xE2 CONFIGURE EXCITATION REGISTER DEFINITION**

BIT NUMBER	D[15:1]	D[0]
Bit Name	N/A	Ext Temp En
Default Value	0000 0000 0000 000	0

The default state of the register configures the auxiliary V<sub>SHUNT</sub> input to measure the differential voltage across the AUXP and AUXM inputs. The maximum measurable voltage that can be applied to the inputs is 80mV.

Setting the Ext Temp En bit to 1 activates the current sourcing circuitry at the auxiliary V<sub>SHUNT</sub> input. Connecting a diode between AUXP and AUXM will enable external temperature measurement functionality.

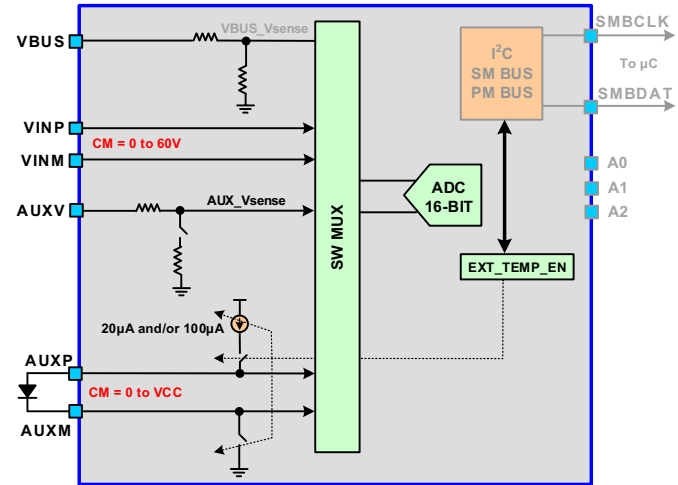

**FIGURE 98. SIMPLIFIED CIRCUIT DIAGRAM OF AN EXTERNAL TEMPERATURE APPLICATION**

The external temperature measurement mode forces two currents (20µA/100µA) through the diode. The differential voltage between the AUXP and AUXM pins for each current forced are measured and stored by way of a sample and hold circuitry. The timing for the two current measurement is 1µs. The maximum voltage that can be measured between the auxiliary Vshunt pins is ±VCC.

Upon completion of the two current measurements, the ADC measures the difference between the two stored differential voltage values. The measured value by the ADC yields the ΔV<sub>be</sub> voltage for the two currents. The maximum ΔV<sub>be</sub> voltage that the temperature circuit can measure is 80mV. The DPM stores the measured value from the ADC in the READ\_TEMPERATURE\_1 register. Using [Equation 2](#) to calculate the register signed integer value, the ΔV<sub>be</sub> voltage can be calculated using [Equation 6](#).

$$\Delta V_{be} = \text{Register Value} \cdot \text{Aux\_Vshunt\_LSB} \quad (\text{EQ. 6})$$

Register<sub>value</sub> is the READ\_TEMPERATURE\_1 signed integer value. The Aux\_Vshunt<sub>LSB</sub> equals 10µV.

[Equation 7](#) yields the absolute temperature from the current measurements.

$$T = \left[ \left( \frac{q}{n \cdot k} \right) \cdot \left( \frac{\Delta V_{be}}{\ln \left( \frac{I_2}{I_1} \right)} \right) \right] - 273 \quad (\text{EQ. 7})$$

The ΔV<sub>be</sub> value calculated in [Equation 6](#) is used to calculate the temperature in centigrade (°C).

The value of the two currents that are sourced from the part during the temperature measurement are 100µA and 20µA.  $I_2$  equal 100µA. The variable  $k$  is Boltzmann constant equal to  $1.3806503 \times 10^{-23} \text{ m}^2 \text{ kg} / \text{S}^2$ . The variable  $q$  is the electron charge constant equal to  $= 1.6 \times 10^{-19} \text{ C}$ . The variable  $n$  is the ideality factor of the temperature diode. A typical value is near 1.

The external temperature feature is a function of the Auxiliary  $V_{\text{SHUNT}}$  conversion time as well as converter averaging. The settings for the aforementioned registers directly impacts the accuracy of the measurement and the timing.

## ENTERING \EXITING THE EXTERNAL TEMPERATURE MODE

Writing a 1 to D[0] of register 0xE2 will not configure the Aux inputs to external temperature sense mode. The following series of commands need to be sent to enable external temperature sense functionality.

1. Power-down the ADC – Set BitD[6] of register 0xD2 to 1.
2. Enable the Ext Temp bit – Set BitD[0] of register 0xDE2 to 1.
3. Power ADC + and set measurement mode to temperature– Set BitD[6] to 0 and set Bits[D2:0] to 6 for register 0xD2.

The external temperature feature is functional in both trigger and continuous modes. Undoing the series of commands listed above will exit the external temperature mode.

## Measurement Registers

### OXD6 READ $V_{\text{SHUNT}}$ OUT (R)

The Read  $V_{\text{SHUNT}}$  Out register is a readable word register that stores the signed measured digital value of the primary  $V_{\text{SHUNT}}$  input of the DPM. Using [Equation 2](#) to calculate the integer value of the register, [Equation 8](#) calculates the floating point measured value for the primary  $V_{\text{SHUNT}}$  channel.

$$V_{\text{shunt}} = \text{Register}_{\text{value}} \cdot v_{\text{shunt}}_{\text{LSB}} \quad (\text{EQ. 8})$$

$v_{\text{shunt}}_{\text{LSB}}$  is the numerical weight of each level for the  $V_{\text{SHUNT}}$  channel, which equals 2.5µV.

### OX8B READ $V_{\text{OUT}}$ (R)

The Read  $V_{\text{OUT}}$  register is a readable word register that stores the unsigned measured digital value of the primary  $V_{\text{BUS}}$  input of the DPM. Using [Equation 1](#) to calculate the integer value of the register, [Equation 9](#) calculates the floating point measured value for the primary  $V_{\text{BUS}}$  channel.

$$V_{\text{bus}} = \text{Register}_{\text{value}} \cdot v_{\text{bus}}_{\text{LSB}} \quad (\text{EQ. 9})$$

$v_{\text{bus}}_{\text{LSB}}$  is the numerical weight of each level for the  $V_{\text{BUS}}$  channel. The  $v_{\text{bus}}_{\text{LSB}}$  equals 1mV for the 60V version of the DPM and 250µV for the 12V version of the DPM.

### OX8C READ $I_{\text{OUT}}$ (R)

The Read  $I_{\text{OUT}}$  register is a readable word register that stores the signed measured digital value of the current passing through the primary channel's shunt. The register uses the measured value

from  $V_{\text{SHUNT}}$  and the  $I_{\text{OUT\_CAL\_GAIN}}$  register. [Equation 10](#) yields the current for the primary channel.

$$\text{Current} = \text{Register}_{\text{value}} \cdot \text{Current}_{\text{LSB}} \quad (\text{EQ. 10})$$

The  $\text{Register}_{\text{value}}$  is calculated using [Equation 2](#) on [page 31](#). The  $\text{Current}_{\text{LSB}}$  is calculated using [Equation 4](#) on [page 33](#).

### OXD8 READ PEAK MIN $I_{\text{OUT}}$ (R)

### OXD9 READ PEAK MAX $I_{\text{OUT}}$ (R)

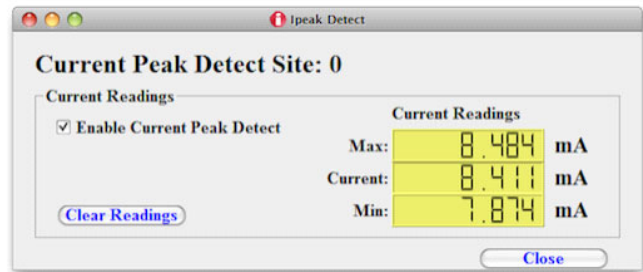

FIGURE 99. THE ISL28023 TRACKS MINIMUM AND MAXIMUM AVERAGE CURRENT READINGS

The Read Peak Min/Max  $I_{\text{OUT}}$  registers are readable word registers that store the minimum and maximum current value of an averaging cycle for the current passing through the primary shunt.

The min/max current tracking is enabled by setting the Peak Detect Enable bit in the  $\text{CONFIG\_PEAK\_DET}$  (0xD7) register. The current peak detect feature only works for the current register.

At the conclusion of each primary channel current, the DPM will record and store the minimum and maximum values of the current measured. The feature operates for both the trigger and continuous modes. Disabling the Peak Detector Enable bit will turn off the feature as well as clear the Read Peak Min/Max  $I_{\text{OUT}}$  registers.

### OX96 READ $P_{\text{OUT}}$ (R)

The Read  $P_{\text{OUT}}$  register is a signed readable word register that reports the digital value of the power from the primary channel. The register uses the values from  $\text{READ\_IOUT}$  and  $\text{READ\_VSHUNT\_OUT}$  registers to calculate the power.

The units for the power register are in watts. The power can be calculated using [Equation 11](#).

$$\text{Power} = \text{Register}_{\text{value}} \cdot \text{Power}_{\text{LSB}} \cdot 40000 \quad (\text{EQ. 11})$$

The  $\text{Register}_{\text{value}}$  is calculated using [Equation 2](#). The  $\text{Power}_{\text{LSB}}$  can be calculated from [Equation 12](#).

$$\text{Power}_{\text{LSB}} = \text{Current}_{\text{LSB}} \cdot V_{\text{bus}}_{\text{LSB}} \quad (\text{EQ. 12})$$

The  $V_{\text{BUS}}_{\text{LSB}}$  equals 1mV for the 60V version of the DPM and 250µV for the 12V version of the DPM. The  $\text{Current}_{\text{LSB}}$  is the value yielded from [Equation 4](#) on [page 33](#).

### OXE0 READ V<sub>SHUNT</sub> OUT AUX (R)

The Read V<sub>SHUNT</sub> Out Aux register is a readable word register that stores the signed measured digital value of the auxiliary V<sub>SHUNT</sub> input. Use Equation 2 to calculate the integer value of the register, Equation 13 calculates the floating point measured value for the auxiliary V<sub>SHUNT</sub> channel.

$$V_{shunt\_aux} = \text{Register\_value} \cdot v_{shunt\_aux\_LSB} \quad (\text{EQ. 13})$$

V<sub>shunt\_aux</sub><sub>LSB</sub> is the numerical weight of each level for the auxiliary V<sub>SHUNT</sub> channel. The V<sub>shunt\_aux</sub><sub>LSB</sub> equals 2.5μV.

### OXE1 READ V<sub>OUT</sub> AUX (R)

The Read V<sub>OUT</sub> Aux register is a readable word register that stores the unsigned measured digital value of the auxiliary V<sub>BUS</sub> input of the DPM. Using Equation 1 to calculate the integer value of the register, Equation 14 calculates the floating point measured value for the auxiliary V<sub>BUS</sub> channel.

$$V_{bus} = \text{Register\_value} \cdot v_{bus\_LSB} \quad (\text{EQ. 14})$$

V<sub>BUS</sub><sub>LSB</sub> is the numerical weight of each level for the auxiliary V<sub>BUS</sub> channel. The auxiliary V<sub>BUS</sub><sub>LSB</sub> equals 100μV. The voltage range for the auxiliary V<sub>BUS</sub> is 0 to V<sub>CC</sub>.

### OX8D READ TEMPERATURE (R)

The read temperature register is a readable word register that reports out the internal or external temperature of the chip. The register is a 16-bit signed register. Bit15 of the register is the signed bit. The register value can be calculated using Equation 15.

$$\text{Register\_Value} = \left[ \sum_{n=0}^{14} (\text{Bit\_Val}_n \cdot 2^n) \right] - (\text{Bit\_Val}_{15} \cdot 2^{15}) \quad (\text{EQ. 15})$$

n is the bit position within the register value. Bit\_Val is the value of the bit either 1 or 0. The register value multiplied by 0.016 yields the internal temperature reading in Centigrade (°C).

### Threshold Detectors

The DPM has three integrated comparators that allow for real time fault detection of overvoltage, undervoltage for the primary V<sub>BUS</sub> input and an overcurrent detection for the primary V<sub>SHUNT</sub> input. An over-temperature detection is available by multiplexing the input to the overvoltage comparator.

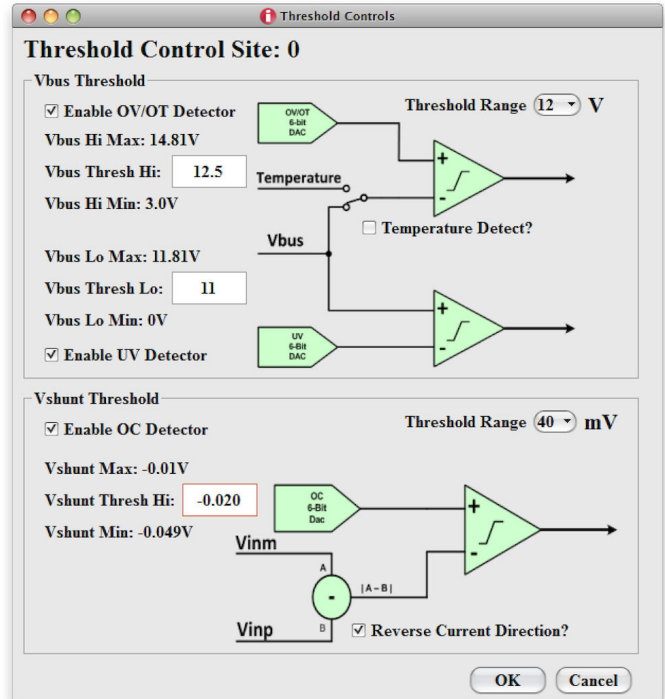

FIGURE 100. SIMPLIFIED BLOCK DIAGRAM OF THE THRESHOLD FUNCTIONS WITHIN THE DPM

### OXDA V<sub>OUT</sub> OV THRESHOLD SET (R/W)

The V<sub>OUT</sub> OV Threshold Set register is a read/writable word register that controls the threshold voltage level to the overvoltage comparator. The description of the functionality within this register is found in Table 22.

The compared reference voltage level to the OV comparator is generated from a 6-bit DAC. The 6-bit DAC has 4 or 6 voltage ranges to improve detection voltage resolution for a specific voltage range.

TABLE 22. OxDA V<sub>OUT</sub> OV THRESHOLD SET REGISTER DEFINITION

BIT NUMBER	D[15:10]	D[9]	D[8:6]	D[5:0]
Bit Name	N/A	OV_OT_SEL	Vbus_Thres_Ryng	Vbus_OV_OT_Set
Default Value	0000 00	0	0 00	11 1111

#### OV\_OT\_SEL D[9]

The OV\_OT\_SEL bit configures the multiplexer to the input of the OV comparator to either compare for over-temperature or overvoltage. Setting the OV\_OT\_SEL to a 1 configures the OV comparator to detect for an over-temperature condition.

#### VBUS\_THRES\_RNG D[8:6]

The Vbus\_Thres\_Rng bits sets the threshold voltage range for the overvoltage and undervoltage DACs. There are 6 selectable ranges for the 60V version of the DPM. Only 4 selectable ranges for the 12V version of the DPM. Table 23 defines the range settings for the V<sub>BUS</sub> threshold detector. The yellow shaded row denotes the default setting.

The temperature threshold reference level has one range setting which equals +125 °C at full-scale.

**TABLE 23. Vbus\_Thres\_Rng BITS DEFINED**

Vbus_Thres_Rng: D[8:6]			Vbus_12V (RANGE)	Vbus_60V (RANGE)
0	0	0	12	48
0	0	1	6	24
0	1	0	3	12
0	1	1	1.25	5
1	0	0	X	3.3
1	0	1	X	2.5

### VBUS\_OV\_OT\_SET D[5:0]

The Vbus\_OV\_OT\_Set bits controls the voltage/temperature level to the input of the OV comparator. The LSB of the DAC is 1.56% of the full-scale range chosen using the Vbus\_Thres\_Rng bits. For the temperature feature, the LSB for the temperature level is 5.71 °C. The mathematical range is -144 °C to +221.4 °C.

The overvoltage range starts at 25% of the full-scale range chosen using the Vbus\_Thres\_Rng bits and ends at 125% of the chosen full-scale range. The same range applies to the temperature measurements.

**TABLE 24. Vbus\_OV\_OT\_Set BITS DEFINED**

Vbus_OV_OT_Set: D[5:0]	OV THRESHOLD VALUE	OT THRESHOLD VALUE
00 0000	25% of FS	-144
00 0001	(25 + 1.56)% of FS	-138.3
00 0010	(25 + 3.12)% of FS	-132.6
.....	.....	.....
11 1101	(125 to 4.68)% of FS	210
11 1110	(125 to 3.12)% of FS	215.7
11 1111	(125 to 1.56)% of FS	221.4

[Table 24](#) defines an abbreviated breakdown to set the OV/OT comparator level. The shaded row is the default condition.

### OXDB V<sub>OUT</sub> UV THRESHOLD SET (R/W)

The V<sub>OUT</sub> UV Threshold Set register is a read/writable byte register that controls the threshold voltage level to the undervoltage comparator. The description of the functionality within this register is found in [Table 25](#).

The compared reference voltage level to the UV comparator is generated from a 6-bit DAC. The 6-bit DAC has 4 to 6 voltage ranges that are determined by the Vbus\_Thres\_Rng bits in the V<sub>OUT</sub> UV Threshold Set register.

**TABLE 25. OXDB V<sub>OUT</sub> UV THRESHOLD SET REGISTER DEFINITION**

BIT NUMBER	D[7:6]	D[5:0]
Bit Name	N/A	Vbus_UV_Set
Default Value	00	00 0000

### VBUS\_UV\_SET D[4:0]

The Vbus\_UV\_Set bits control the undervoltage level to the input of the UV comparator. The LSB of the DAC is 1.56% of the full-scale range chosen using the Vbus\_Thres\_Rng bits.

The undervoltage ranges from 0% to 100% of the full-scale range set by the Vbus\_Thres\_Rng bits.

**TABLE 26. Vbus\_UV\_Set BITS DEFINED**

Vbus_UV_Set: D[5:0]	UV THRESHOLD VALUE
00 0000	0%
00 0001	1.56% of FS
00 0010	3.12% of FS
.....	.....
11 1101	(100 - 4.68)% of FS
11 1110	(100 - 3.12)% of FS
11 1111	(100 - 1.56)% of FS

[Table 26](#) defines an abbreviated breakdown to set the undervoltage comparator levels. The shaded row is the default condition.

### OXDC I<sub>OUT</sub> OC THRESHOLD SET (R/W)

The I<sub>OUT</sub> OC Threshold Set register is a read/writable word register that controls the threshold current level to the overcurrent comparator. The description of the functionality within this register is found in [Table 27](#).

**TABLE 27. OXDC I<sub>OUT</sub> OC THRESHOLD SET REGISTER DEFINITION**

BIT NUMBER	D[15:10]	D[9]	D[8:7]	D[6]	D[5:0]
Bit Name	N/A	Iout_Dir	N/A	V <sub>SHUNT</sub> Thres Rng	Vshunt_OC_Set
Default Value	0000 00	0	0 0	0	11 1111

The overcurrent threshold is defined through the V<sub>SHUNT</sub> reading. The product of the current through the shunt resistor defines the V<sub>SHUNT</sub> voltage to the DPM. The current through the shunt resistor is directly proportional the V<sub>SHUNT</sub> voltage measured by the DPM. An overvoltage threshold for V<sub>SHUNT</sub> is the same as an overcurrent threshold.

### IOUT\_DIR D[9]

The Iout\_Dir bit controls the polarity of the V<sub>SHUNT</sub> voltage threshold. The bit functionality allows an overcurrent threshold to be set for currents flowing from VINP to VINM and the reverse direction. [Table 28](#) defines the range settings for the V<sub>BUS</sub> threshold detector. The yellow shaded row denotes the default setting.

**TABLE 28. Vbus\_Thres\_Rng BITS DEFINED**

Iout_Dir: D[9]	CURRENT DIRECTION
0	VINP to VINM
1	VINM to VINP

**VSHUNT\_THRES\_RNG D[6]**

The Vshunt\_Thres\_Rng bit sets the overvoltage threshold range for the overcurrent DAC. The selectable V<sub>SHUNT</sub> range improves the overvoltage threshold resolution for lower full-scale current applications. Table 29 defines the range settings for the V<sub>BUS</sub> threshold detector. The yellow shaded row denotes the default setting.

TABLE 29. Vshunt\_Thres\_Rng BIT DEFINED

Vshunt_Thres_Rng: D[6]	VSHUNT (RANGE)
0	80mV
1	40mV

**VSHUNT\_OC\_SET D[5:0]**

The Vshunt\_OC\_Set bits control the V<sub>SHUNT</sub> voltage level to the input of the OC comparator. The LSB of the DAC is 1.56% of the full-scale range chosen using the Vshunt\_Thres\_Rng bits.

The overvoltage range starts at 25% of the full-scale range chosen using Vbus\_Thres\_Rng bits and ends at 125% of the chosen full-scale range.

TABLE 30. Vshunt\_OC\_Set BITS DEFINED

Vshunt_OC_Set: D[5:0]	OC THRESHOLD VALUE
00 0000	25% of FS
00 0001	(25 + 1.56)% of FS

TABLE 30. Vshunt\_OC\_Set BITS DEFINED

Vshunt_OC_Set: D[5:0]	OC THRESHOLD VALUE
00 0010	(25 + 3.12)% of FS
.....	.....
11 1101	(125 - 4.68)% of FS
11 1110	(125 - 3.12)% of FS
11 1111	(125 - 1.56)% of FS

**SMB Alert**

The DPM has two alert pins (SmbAlert1, SmbAlert2) to alert the peripheral circuitry that a failed event has occurred. SmbAlert1 output is an open-drain allowing the user the flexibility to connect the alert pin to other components requiring different logic voltage levels than the DPM. The SmbAlert2 has a push/pull output stage for driving pins with logic voltage levels equal to the voltage applied to I2CVCC pin. The push/pull output is useful for driving peripheral components that require the DPM to source and sink a current. The alert pins are commonly connected to an interrupt pin of a microcontroller or an enable pin of a device.

The SMB Alert registers control the functionality of the SMB Alert pins. The threshold comparators are the inputs to the SMB Alert registers. The outputs are the SMB Alert pins. Figure 101 on page 38 is a simple functional block diagram of the SMB Alert features.

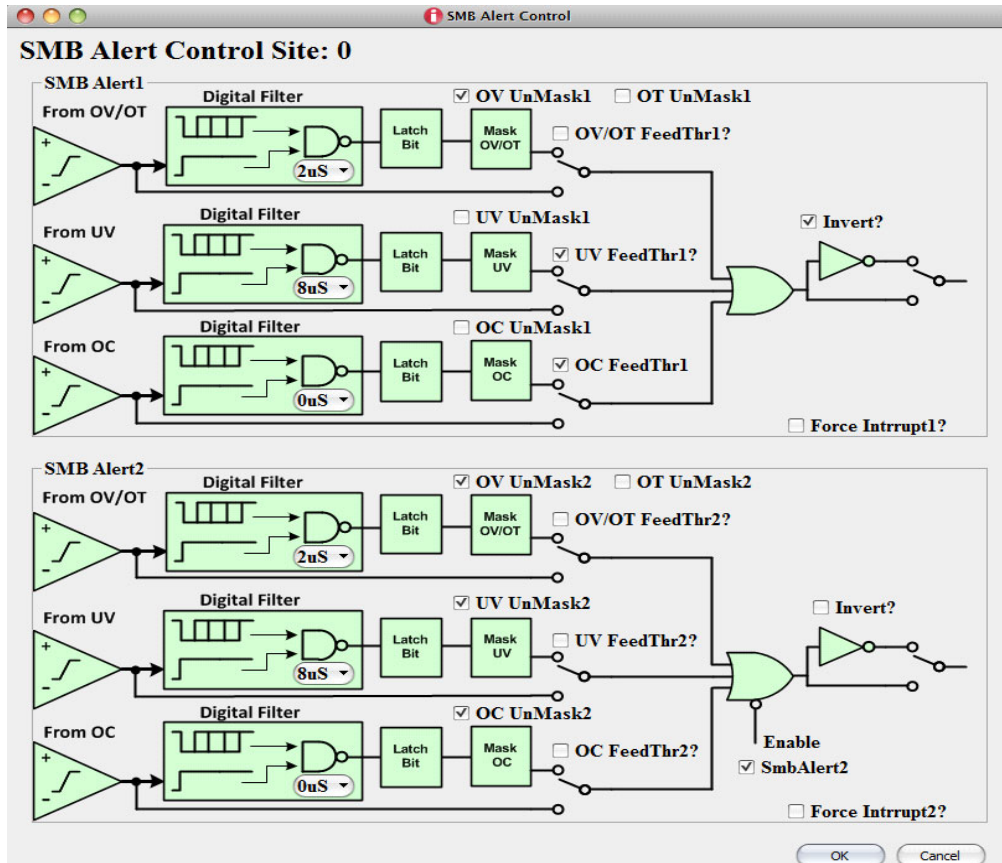

FIGURE 101. SIMPLIFIED BLOCK DIAGRAM OF THE SMB ALERT FUNCTIONS WITHIN THE DPM

## 0XDD CONFIGURE INTERRUPTS (R/W)

The Configure Interrupt register is a read/writable word register that controls the behavior of the two SMB alert pins. The definition of the control bits within the Configure Interrupt register is defined in [Table 31](#).

TABLE 31. 0XDD CONFIGURE INTERRUPT REGISTER DEFINITION

BIT NUMBER	D [15]	D [14:12]	D [11:9]	D [8:7]	D [6:5]	D [4:3]	D [2]	D [1]	D [0]
Bit Name	N/A	ALERT2 FeedTh	ALERT1 FeedTh	OC FIL	OV FIL	UV FIL	OC EN	OV EN	UV EN
Default Value	0	000	000	0 0	00	0 0	0	0	0

### ALERT2\_FEEDTHR D[14:12]

The Alert2\_FeedThr bits determine whether the bit from each alert comparator is digitally conditioned or not. The alert comparators, digital filters and latching bits are the same for both SMB alert channels. [Table 32](#) defines the functionality of the Alert2\_FeedThr bits.

TABLE 32. Alert2\_FeedThr BITS DEFINED

Alert2_FeedThr BITS D[14:12]	BIT VAL	FUNCTIONALITY
D[14]	0	OV/OT Digitally Conditioned
	1	OV/OT Pass Through
D[13]	0	UV Digitally Conditioned
	1	UV Pass Through
D[12]	0	OC Digitally Conditioned
	1	OC Pass Through

### ALERT1\_FEEDTHR D[11:9]

The Alert1\_FeedThr bits determine whether the bit from each alert comparator is digitally conditioned or not. The alert comparators, digital filters and latching bits are the same for both SMB alert channels. [Table 33](#) defines the functionality of the Alert1\_FeedThr bits.

TABLE 33. Alert1\_FeedThr BITS DEFINED

Alert1_FeedThr Bits D[11:9]	BIT VAL	FUNCTIONALITY
D[11]	0	OV/OT Digitally Conditioned
	1	OV/OT Pass Through
D[10]	0	UV Digitally Conditioned
	1	UV Pass Through
D[9]	0	OC Digitally Conditioned
	1	OC Pass Through

### OC\_FIL D[8:7]

The OC\_FIL bits control the digital filter for the overcurrent circuitry. The digital filter will prevent short duration events from passing to the output pins. The filter is useful in preventing high frequency power glitches from triggering a shutdown event. The filter time delay ranges from 0 $\mu$ s to 8 $\mu$ s. An 8 $\mu$ s filter setting

requires an error event to be at least 8 $\mu$ s in duration before passing the result to the SMB alert pins. There is one OC digital filter for both SMB alert pins. Configuring OC\_FIL bits will change the OC digital filter setting for both SMB alert pins. See [Table 34](#) for the filter selections.

### UV\_FIL D[6:5]

The UV\_FIL bits control the digital filter for the undervoltage circuitry. The digital filter will prevent short duration events from passing to the output pins. The filter is useful in preventing high frequency power glitches from triggering a shutdown event. The filter time delay ranges from 0 $\mu$ s to 8 $\mu$ s. An 8 $\mu$ s filter setting requires an error event to be at least 8 $\mu$ s in duration before passing the result to the SMB alert pins. There is one UV digital filter for both SMB alert pins. Configuring UV\_FIL bits will change the UV digital filter setting for both SMB alert pins. See [Table 34](#) for the filter selections.

### OV\_FIL D[4:3]

The OV\_FIL bits control the digital filter for the overvoltage circuitry. The digital filter will prevent short duration events from passing to the output pins. The filter is useful in preventing high frequency power glitches from triggering a shutdown event. The filter time delay ranges from 0 $\mu$ s to 8 $\mu$ s. An 8 $\mu$ s filter setting requires an error event to be at least 8 $\mu$ s in duration before passing the result to the SMB alert pins. There is one OV digital filter for both SMB alert pins. Configuring OV\_FIL bits will change the OV digital filter setting for both SMB alert pins. See [Table 34](#) for the filter selections.

TABLE 34. DIGITAL GLITCH FILTER SETTINGS DEFINED

OC_FIL D[8:7]	UV_FIL D[6:5]	OV_FIL D[4:3]	FILTER TIME ( $\mu$ s)
0	0	0	0
0	1	0	2
1	0	0	4
1	1	0	8

### OC\_EN D[2]

The OC\_EN enable bit controls the power to the overcurrent DAC and comparator. Setting the bit to 1 enables the overcurrent circuitry.

### OV\_EN D[1]

The OV\_EN enable bit controls the power to the overvoltage DAC and comparator. Setting the bit to 1 enables the overvoltage circuitry.

### UV\_EN D[0]

The UV\_EN enable bit controls the power to the undervoltage DAC and comparator. Setting the bit to 1 enables the undervoltage circuitry.

## OXDE FORCE FEEDTHROUGH ALERT REGISTER (R/W)

The Force Feedthrough Alert Register is a read/writable byte register that controls the polarity of the interrupt. The definition

of the control bits within the Force Feedthrough Alert register is defined in [Table 35](#).

**TABLE 35. 0xDE FORCE FEEDTHROUGH ALERT REGISTER DEFINITION**

BIT NUMBER	D[7:4]	D[3]	D[2]	D[1]	D[0]
Bit Name	N/A	A2POL	A1POL	FORCE A2	FORCE A1
Default Value	0000	0	0	0	0

### A2POL D[3], A1POL D[2]

The AxPOL bits control the polarity of an interrupt. A2POL bit defines the SMBALERT2 pin active interrupt state. A1POL bit defines the SMBALERT1 pin active interrupt state. [Table 36](#) defines the functionality of the bit.

**TABLE 36. AxPOL BIT DEFINED**

A2POL D[3], A1POL D[2]	INTERRUPT ACTIVE STATE
0	Low
1	High

### FORCEA2 D[1], FORCEA1 D[0]

The FORCEAx bits allow the user to force an interrupt by setting the bit. FORCEA2 bit controls the SMBALERT2 pin state. FORCEA1 bit controls the SMBALERT1 pin state. [Table 37](#) defines the functionality of the bit.

**TABLE 37. FORCEAx BIT DEFINED**

FORCEA2 D[1], FORCEA1 D[0]	INTERRUPT STATUS
0	Normal
1	Interrupt Forced

### 0X03 CLEAR FAULTS (S)

The Clear Faults register is a send byte command that clears all faults pertaining to the status registers. Upon execution of the command, the status registers return to the default state defined in [Table 2 on page 28](#).

### 0X7A STATUS V<sub>OUT</sub> (R/W)

The Status V<sub>OUT</sub> register is a read/writable byte register that reports over and undervoltage warnings for the V<sub>BUS</sub> input.

**TABLE 38. 0x7A STATUS V<sub>OUT</sub> REGISTER DEFINITION**

BIT NUMBER	D[7]	D[6]	D[5]	D[4:0]
Bit Name	N/A	V <sub>OUT</sub> OV Warning	V <sub>OUT</sub> UV Warning	N/A
Default Value	0	0	0	0 0000

### V<sub>OUT</sub> OV WARNING D[6]

The V<sub>OUT</sub> OV Warning bit is set to 1 when an overvoltage fault occurs on the V<sub>BUS</sub> input. The V<sub>BUS</sub> overvoltage threshold is set from the V<sub>OUT</sub> OV Threshold Set register. In the event of a V<sub>BUS</sub> overvoltage condition, the V<sub>OUT</sub> OV Warning is latched to 1.

Writing a 1 to the V<sub>OUT</sub> OV Warning bit will clear the warning resulting in a bit value equal to 0.

### V<sub>OUT</sub> UV WARNING D[5]

The V<sub>OUT</sub> UV Warning bit is set to 1 when an undervoltage fault occurs on the V<sub>BUS</sub> input. The V<sub>BUS</sub> undervoltage threshold is set from the V<sub>OUT</sub> UV Threshold Set register. In the event of a V<sub>BUS</sub> undervoltage condition, the V<sub>OUT</sub> UV Warning is latched to 1. Writing a 1 to the V<sub>OUT</sub> UV Warning bit will clear the warning resulting in a bit value equal to 0.

### 0X7B STATUS I<sub>OUT</sub> (R/W)

The Status I<sub>OUT</sub> register is a read/writable byte register that reports an overcurrent warning for the V<sub>SHUNT</sub> input.

**TABLE 39. 0x7B STATUS I<sub>OUT</sub> REGISTER DEFINITION**

BIT NUMBER	D[7]	D[6]	D[5]	D[4:0]
Bit Name	N/A	N/A	I <sub>OUT</sub> OC Warning	N/A
Default Value	0	0	0	0 0000

### I<sub>OUT</sub> OC WARNING D[5]

The I<sub>OUT</sub> OC Warning bit is set to 1 when an overcurrent fault occurs on the V<sub>SHUNT</sub> input. The V<sub>SHUNT</sub> overcurrent threshold is set from the I<sub>OUT</sub> OC Threshold Set register. In the event of a V<sub>SHUNT</sub> overcurrent condition, the I<sub>OUT</sub> OC Warning is latched to 1. Writing a 1 to the I<sub>OUT</sub> OC Warning bit will clear the warning resulting in a bit value equal to 0.

### 0X7D STATUS TEMPERATURE (R/W)

The Status Temperature register is a read/writable byte register that reports an over-temperature warning initiated from the internal temperature sensor.

**TABLE 40. 0x7D STATUS TEMPERATURE REGISTER DEFINITION**

BIT NUMBER	D[7]	D[6]	D[5]	D[4:0]
Bit Name	N/A	OT Warning	N/A	N/A
Default Value	0	0	0	0 0000

### OT WARNING D[6]

The OT Warning bit is set to 1 when an over-temperature fault occurs from the internal temperature sensor. The over-temperature threshold is set from the V<sub>OUT</sub> OV Threshold Set register. In the event of an over-temperature condition, the OT Warning bit is latched to 1. Writing a 1 to the OT Warning bit will clear the warning resulting in a bit value equal to 0.

### 0X7E STATUS CML (R/W)

The Status CML register is a read/writable byte register that reports warnings and errors associated with communications, logic and memory.

**TABLE 41. 0x7E STATUS CML REGISTER DEFINITION**

BIT NUMBER	D[7]	D[6]	D[5]	D[4:2]	D[1]	D[0]
Bit Name	USCMD	USDATA	PECERR	N/A	COMERR	N/A



**TABLE 41. 0x7E STATUS CML REGISTER DEFINITION**

BIT NUMBER	D[7]	D[6]	D[5]	D[4:2]	D[1]	D[0]
Default Value	0	0	0	0 00	0	0

**USCMD D[7]**

The USCMD bit is set to 1 when an unsupported command is received from the I<sup>2</sup>C master. Reading from an undefined register is an example of an action that would set the USCMD bit. The USCMD bit is a latched bit. Writing a 1 to the USCMD bit clears the warning resulting in a bit value equal to 0.

**USDATA D[6]**

The USDATA bit is set to 1 when an unsupported data is received from the I<sup>2</sup>C master. Writing a word to a byte register is an example of an action that would set the USDATA bit. The USDATA bit is a latched bit. Writing a 1 to the USDATA bit clears the warning resulting in a bit value equal to 0.

**PECERR D[5]**

The PECERR bit is set to 1 when a Packet Error Check (PEC) event has occurred. Writing the wrong PEC to the DPM is an example of an action that would set the PECERR bit. The PECERR bit is a latched bit. Writing a 1 to the PECERR bit clears the warning resulting in a bit value equal to 0.

**COMERR D[1]**

The COMERR bit is set to 1 for communication errors that are not handled by the USCMD, USDATA and PECERR errors. Reading from a write only register is an example of an action that would set the COMERR bit. The COMERR bit is a latched bit. Writing a 1 to the COMERR bit clears the warning resulting in a bit value equal to 0.

**0X78 STATUS BYTE (R/W)**

The Status Byte register is a read/writable byte register that is a hierarchal register to the Status Temperature and Status CML registers. The Status Byte registers bits are set if an over temperature or a CML error has occurred.

**TABLE 42. 0x78 STATUS BYTE REGISTER DEFINITION**

BIT NUMBER	D[7]	D[6:3]	D[2]	D[1]	D[0]
Bit Name	BUSY	N/A	Temperature	CML	N/A
Default Value	0	000 0	0	0	0

**BUSY D[7]**

The BUSY bit is set to 1 when the DPM is busy and unable to respond. The BUSY bit is a latched bit. Writing a 1 to the BUSY bit clears the warning resulting in a bit value equal to 0.

**TEMPERATURE D[2]**

The Temperature bit is set to 1 when an over-temperature fault occurs from the internal temperature sensor. This bit is the same action bit as the OT Warning bit in the Status Temperature register. The over-temperature threshold is set from the V<sub>OUT</sub> OV Threshold Set register. In the event of an over-temperature condition, the Temperature bit is latched to 1. Writing a 1 to the

Temperature bit will clear the warning resulting in a bit value equal to 0.

**CML D[1]**

The CML bit is set to 1 when any errors occur within the Status CML register. There are four Status CML error bits that can set the CML bit. The CML bit is a latched bit. Writing a 1 to the CML bit clears the warning resulting in a bit value equal to 0.

**0X79 STATUS WORD (R/W)**

The Status Word register is a read/writable word register that is a hierarchal register to the Status V<sub>OUT</sub>, Status I<sub>OUT</sub> and Status Byte registers. The Status Word registers bits are set when any errors previously described occur. The register generically reports all errors.

**TABLE 43. 0x79 STATUS WORD REGISTER DEFINITION**

BIT NUMBER	D[15]	D[14]	D[13:8]	D[7:0]
Bit Name	V <sub>OUT</sub>	I <sub>OUT</sub>	N/A	See Status Byte
Default Value	0	0	00 0000	0000 0000

**V<sub>OUT</sub> D[15]**

The V<sub>OUT</sub> bit is set to 1 when any errors occur within the Status V<sub>OUT</sub> register. Whether either or both an undervoltage or overvoltage fault occurs, the V<sub>OUT</sub> bit will be set. The V<sub>OUT</sub> bit is a latched bit. Writing a 1 to the V<sub>OUT</sub> bit clears the warning resulting in a bit value equal to 0.

**I<sub>OUT</sub> D[14]**

The I<sub>OUT</sub> bit is set to 1 when an overcurrent fault occurs. This bit is the same action bit as the I<sub>OUT</sub> OC Warning bit in the Status I<sub>OUT</sub> register. In the event of an overcurrent condition, the I<sub>OUT</sub> bit is latched to 1. Writing a 1 to the I<sub>OUT</sub> bit will clear the warning resulting in a bit value equal to 0.

**0X1B SMBALERT MASK (BR/BW)****0XDF SMBALERT2 MASK (BR/BW)**

The SMBALERT registers are block read/writable registers that mask error conditions from electrically triggering the respective SMBALERT pin.

The SMBALERT can mask bits of any of the status registers. Masking lower level bits prevents hierarchal bit from being set. For example, a COMERR bit being masked will not set the CML bit of the Status Byte register.

To mask a bit, the first data byte is the register address of the bit(s) to be masked. The second and third data bytes are the masking bits of the register. A masking bit of 1 prevents the signal from triggering an interrupt.

All alert bits are masked as the default state for both the SMB alert pins. The master needs to send instructions to unmask the alert bits.

As an example, a user would like to allow the COMERR bit to trigger a SMBALERT2 interrupt while masking the rest of the alerts within the Status CML register. The command that is sent from the master to the DPM is the slave address, SMBALERT2

register address, Status CML register address and the mask bit value. In a hexadecimal format, the data sent to the DPM is as follows; 0x80 DF 7E FD.

To read the mask status of any alert register, a four byte write command, without PEC, consisting of the slave address of the device, the SMB mask register address, the number of bytes to be read back and the register address of the mask to be read. Once the write command has commenced, a read command consisting of the device slave address and the register address of the SMB mask will return the mask of the desired alert register.

As an example, a user would like to read the status of the Status Byte register. The first command sent to the DPM is in hexadecimal bytes is 0x82 1B 01 78. The second command is a standard read. The slave address is 0x83 (0x82 + read bit set) and the register address is 0x1B.

### SMBALERT1 RESPONSE ADDRESS

It is common that the SMBALERT1 pin of each ISL28023 device is shared to a single GPIO pin of the microcontroller. The SMBALERT1 pin is an open-drain allowing for multiple devices to be OR'ed to a single GPIO pin.

The SMBALERT1 Response Address command reports the slave address of the device that has triggered alert. The SMB Respond Address command is shown in [Figure 102](#).

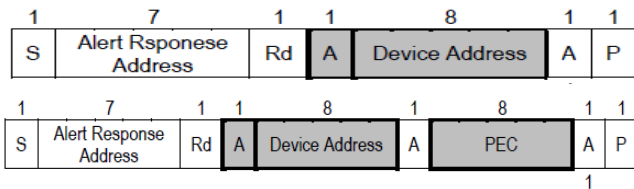

**FIGURE 102. THE COMMAND STRUCTURE OF THE SMBALERT RESPONSE ADDRESS**

The alert response address is 0x18. In the event of multiple alerts pulling down the GPIO line, the alert respond command will return the lowest slave address that is connected to the I<sup>2</sup>C bus. Upon clearing the lowest slave address alert, the alert command will return the lowest slave address of the remaining alerts that are activated.

The alert response is operable when the interrupt active state is forced low by the device at the SMBALERT1 pin. Changing SMBALERT1 interrupt polarity or forcing an interrupt will enable the alert response. By design, the open-drain of the SMBALERT1 pin allows for ANDING of the interrupt via a pull-up resistor. The alert response command is valid for only the SMBALERT1 pin. The alert response command will return a 0x19 when there are no errors that are detected.

### External Clock Control

The DPM has an external clock feature that allows the chip to be synchronized to an external clock. The feature is useful in limiting the number of clocks running asynchronously within a system.

### 0XE5 CONFIGURE EXTERNAL CLOCK (R/W)

The Configure External Clock register is a read/writable byte register that controls the functionality of the external clock feature.

**TABLE 44. 0XE5 CONFIGURE EXTERNAL CLOCK REGISTER DEFINITION**

BIT NUMBER	D[7]	D[6]	D[5:4]	D[3:0]
Bit Name	ExtCLK_EN	SMBALERT2OEN	N/A	EXTCLKDIV
Default Value	0	0	00	0000

#### EXTCLK\_EN D[7]

The ExtClk\_EN bit enables the external clock feature. The ExtClk\_En default bit setting is 0 or disabled. A bit setting of 1 disables the internal oscillator of the DPM and connects circuitry such that the system clock is routed from the external clock pin.

#### SMBALERT2\_OEN D[6]

The SMBALERT2\_OEN bit within the Configure External Clock register either enables or disables the buffer that drives the SMBALERT2 pin.

**TABLE 45. SMBALERT2\_OEN BIT DEFINED**

SMBALERT_OEN	SMBALERT2 STATUS
0	Disabled
1	Enabled

#### EXTCLKDIV D[3:0]

The EXTCLKDIV bits control an internal clock divider that is useful for fast system clocks. The internal clock frequency from pin to chip is represented in [Equation 16](#).

$$f_{\text{req internal}} = \frac{f_{\text{EXTCLK}}}{(\text{ClkDiv} \times 8) + 8} \quad (\text{EQ. 16})$$

$f_{\text{EXTCLK}}$  is the frequency of the signal driven to the External Clock pin. ClkDiv is the decimal value of the clock divide bits.

### Voltage Margin

The voltage margining feature within the DPM is commonly used as a means of testing the robustness of a system. The voltage DAC from the DPM is connected to a summation circuit allowing the voltage sourced from the DAC to raise or lower the overall voltage supply to system. A simplified block diagram is illustrated in [Figure 103](#).

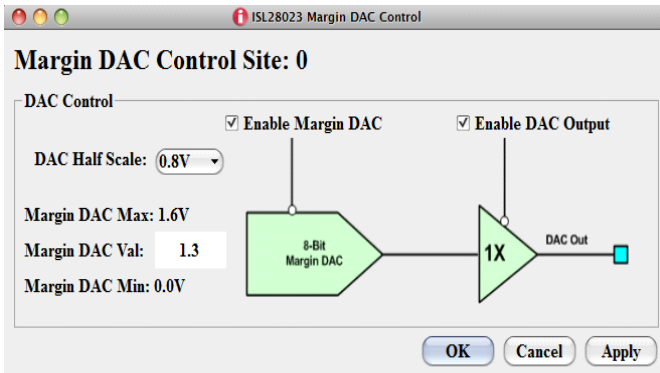

FIGURE 103. SIMPLIFIED BLOCK DIAGRAM OF THE MARGIN DAC FUNCTIONS WITHIN THE DPM

The voltage margining feature can be used to improve accuracy of the voltage applied to the load of a system. For nonfeedback driving applications, the sense resistor used to measure current to the load reduces the voltage to the load. The voltage drop from the sense resistor can be a large percentage with respect to the supply voltage for point of load applications.

#### 0XE4 CONFIGURE VOL MARGIN (R/W)

The Configure VOL Margin register is a read/writable byte register that controls the functionality of the voltage margin DAC.

TABLE 46. 0XE4 CONFIGURE VOL MARGIN REGISTER DEFINITION

BIT NUMBER	D[7:6]	D[5:3]	D[2]	D[1]	D[0]
Bit Name	N/A	MDAC_HS	Load	DAC_OEN	DAC_EN
Default Value	00	00 0	0	0	0

#### MDAC\_HS D[5:3]

The MDAC\_HS bits control the half-scale output voltage from the margin DAC. There are 8 half-scale voltages the margin DAC can be programmed to. Table 47 lists the selections.

TABLE 47. MDAC\_HS BITS DEFINED

MDAC_HS[2:0]			HALF-SCALE VOLTAGE (V)
0	0	0	0.4
0	0	1	0.5
0	1	0	0.6
0	1	1	0.7
1	0	0	0.8
1	0	1	0.9
1	1	0	1.0
1	1	1	1.2

The voltage at the DAC\_OUT is the value of the MDAC\_HS setting when the Set VOL Margin register equals 0x80.

#### LOAD D[2]

The Load bit programs the Set VOL Margin register to the DAC. The DAC is programmed when the Load bit is programmed from a 0 to a 1.

#### DAC\_OEN D[1]

The DAC\_OEN bit either enables or disables the output of the margin DAC. Setting the bit to a 1 connects the output of the margin DAC to the DAC\_OUT pin.

#### DAC\_EN D[0]

The DAC\_EN bit either enables or disables the margin DAC circuitry. Setting the bit to a 1 powers up the margin DAC making it operational to use.

#### 0XE3 SET VOL MARGIN (R/W)

The Set VOL Margin register is an unsigned read/writable byte register that controls the output voltage of the margin DAC referenced to the half-scale setting.

TABLE 48. 0XE3 SET VOL MARGIN REGISTER DEFINITION

BIT NUMBER	D[7:0]
Bit Name	MDAC[7:0]
Default Value	0000 0000

The full-scale voltage is twice the half-scale range minus the DAC LSB for the margin DAC half-scale range. A half-scale setting of 1.0V has a full-scale setting of 1.992V. The LSB for the margin DAC is a function of the half-scale setting. Using Equation 17, the LSB for the margin DAC is calculated as;

$$MDAC_{LSB} = \frac{(2 \cdot MDAC_{HS})}{2^8} = \frac{2 \cdot MDAC_{HS}}{256} \quad (\text{EQ. 17})$$

MDAC<sub>HS</sub> is the half-scale setting for the voltage DAC.

The VOL margin register value for programming the DAC to a specific voltage is calculated using Equation 18.

$$MDAC_{value} = \text{integer} \left( \frac{V_{out\text{desired}}}{MDAC_{LSB}} \right) \quad (\text{EQ. 18})$$

The value for V<sub>OUT</sub><sub>desired</sub> ranges from 0V to two times the MDAC<sub>HS</sub> value minus one MDAC<sub>LSB</sub>.

## SMBus/I<sup>2</sup>C Serial Interface

The ISL28023 supports a bidirectional bus oriented protocol. The protocol defines any device that sends data onto the bus as a transmitter and the receiving device as the receiver. The device controlling the transfer is the master and the device being controlled is the slave. The master always initiates data transfers and provides the clock for both transmit and receive operations. Therefore, the ISL28023 operates as a slave device in all applications.

The ISL28023 uses two bytes data transfer, all reads and writes are required to use two data bytes. All communication over the

I<sup>2</sup>C interface is conducted by sending the MSByte of each byte of data first, followed by the LSByte.

**Protocol Conventions**

For normal operation, data states on the SDA line can change only during SCL LOW periods. SDA state changes during SCL HIGH are reserved for indicating START and STOP conditions (see Figure 104). On power-up, the SDA pin is in the input mode.

All I<sup>2</sup>C interface operations must begin with a START condition, which is a HIGH to LOW transition of SDA while SCL is HIGH. The device continuously monitors the SDA and SCL lines for the START condition and does not respond to any command until this condition is met (see Figure 104, on page 44). A START condition is ignored during the power-up sequence.

All I<sup>2</sup>C interface operations must be terminated by a STOP condition, which is a LOW to HIGH transition of SDA while SCL is HIGH (see Figure 104). A STOP condition at the end of a read operation or at the end of a write operation places the device in its standby mode.

**SMBus, PMBus Support**

The ISL28023 supports SMBus and PMBus protocol, which is a subset of the global I<sup>2</sup>C protocol. SMBCLK and SMBDAT have the same pin functionality as the SCL and SDA pins, respectively. The SMBus operates at 100kHz. The PMBus protocol standardizes the functionality of each register by address.

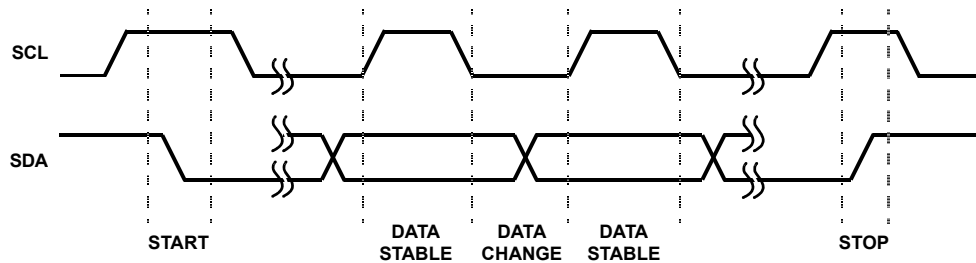

FIGURE 104. VALID DATA CHANGES, START AND STOP CONDITIONS

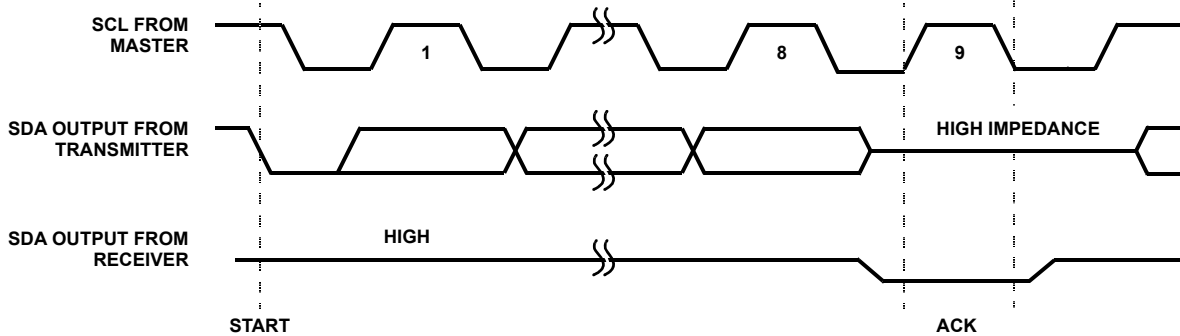

FIGURE 105. ACKNOWLEDGE RESPONSE FROM RECEIVER

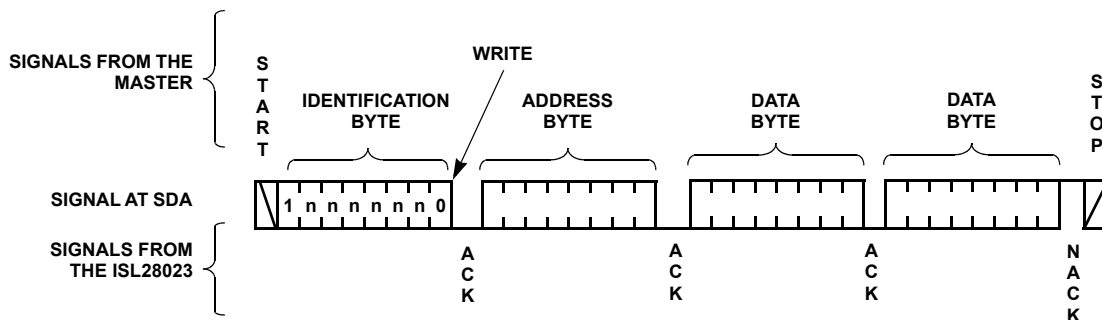

FIGURE 106. BYTE WRITE SEQUENCE (SLAVE ADDRESS INDICATED BY nnnnnn)

## Device Addressing

Following a start condition, the master must output a slave address byte. The 7 MSBs are the device identifiers. The A0, A1 and A2 pins control the bus address (these bits are shown in [Table 49](#)). There are 55 possible combinations depending on the A0, A1 and A2 connections.

The last bit of the slave address byte defines a read or write operation to be performed. When this R/W bit is a "1", a read operation is selected. A "0" selects a write operation (refer to [Figure 102](#)).

After loading the entire slave address byte from the SDA bus, the device compares with the internal slave address. Upon a correct compare, the device outputs an acknowledge on the SDA line.

TABLE 49. I<sup>2</sup>C SLAVE ADDRESSES

A2	A1	A0	SLAVE ADDRESS
GND	GND	GND	1000 000
GND	GND	I2CVCC	1000 001
GND	GND	SDA	1000 010
GND	GND	SCL	1000 011
GND	I2CVCC	GND	1000 100
GND	I2CVCC	I2CVCC	1000 101
GND	I2CVCC	SDA	1000 110
GND	I2CVCC	SCL	1000 111
GND	SDA	GND	1001 000
GND	SDA	I2CVCC	1001 001
GND	SDA	SDA	1001 010
GND	SDA	SCL	1001 011
GND	SCL	GND	1001 100
GND	SCL	I2CVCC	1001 101
GND	SCL	SDA	1001 110
GND	SCL	SCL	1001 111
I2CVCC	GND	GND	1010 000
.....	.....	.....	.....
I2CVCC	SCL	SCL	1011 111
SDA	GND	GND	1100 000
SDA	GND	VCC	Do Not Use. Reserved
.....	.....	.....	.....
SDA	SCL	SCL	1101 111
SCL	GND	GND	1110 000
.....	.....	.....	.....
SCL	SDA	X	Do Not Use. Reserved
SCL	SCL	X	Do Not Use. Reserved

Following the slave byte is a one byte word address. The word address is either supplied by the master device or obtained from an internal counter. On power-up, the internal address counter is set to address 00h, so a current address read starts at address 00h. When required, as part of a random read, the master must supply the one word address bytes, as shown in [Figure 108](#).

In a random read operation, the slave byte in the “dummy write” portion must match the slave byte in the “read” section. For a random read of the registers, the slave byte must be “1nnnnnx” in both places.

### Write Operation

A write operation requires a START condition, followed by a valid identification byte, a valid Address byte, two data bytes and a STOP condition. The first data byte contains the MSB of the data, the second contains the LSB. After each of the four bytes, the device responds with an ACK. At this time, the I<sup>2</sup>C interface enters a standby state.

### Read Operation

A read operation consists of a three byte instruction, followed by two data bytes (see [Figure 108](#)). The master initiates the operation issuing the following sequence: A START, the identification byte with the R/W bit set to “0”, an address byte, a second START and a second identification byte with the R/W bit set to “1”. After each of the three bytes, the ISL28023 responds with an ACK. Then the ISL28023 transmits two data bytes as long as the master responds with an ACK during the SCL cycle following the eighth bit of the first byte. The master terminates the read operation (issuing no ACK then a STOP condition) following the last bit of the second data byte (see [Figure 108](#)).

The data bytes are from the memory location indicated by an internal pointer. This pointer’s initial value is determined by the

address byte in the read operation instruction and increments by one during transmission of each pair of data bytes.

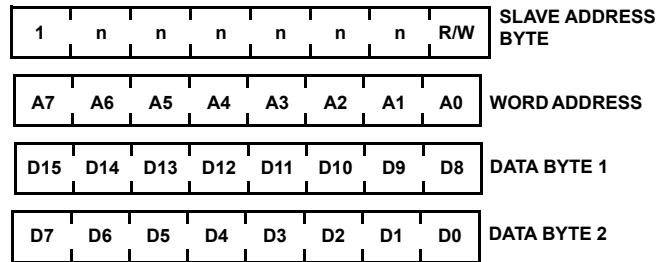

FIGURE 107. SLAVE ADDRESS, WORD ADDRESS AND DATA BYTES

### Group Command

The DPM has a feature that allows the master to configure the settings of all DPM chips at once. The configuration command for each device does not have to be same. Device 1 on an I<sup>2</sup>C bus could be configured to set the voltage threshold of the OV comparator while device 2 is configured for the acquisition time of the V<sub>BUS</sub> input. To achieve the scenario described without group command, the master sends two write commands, one to each slave device. Each command sent from the master has a start bit and a stop bit. The group command protocol concatenates the two commands but replaces the stop bit of the first command and the start bit of the second command with a repeat start bit. The actions sent in a Group Command format will execute once the stop bit has been sent. The stop bit signifies the end of a packet.

The broadcast feature saves time in configuring the DPM as well as measuring signal parameters in time synchronization. The broadcast should not be used for DPM read backs. This will cause all devices connected to the I<sup>2</sup>C bus to talk to the master simultaneously.

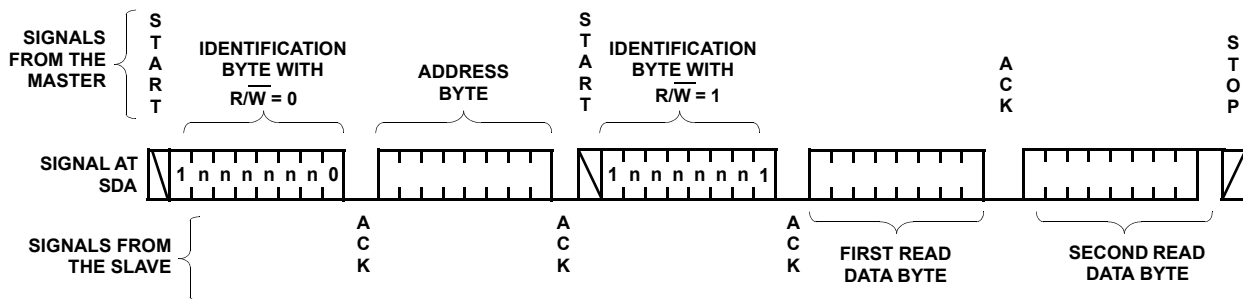

FIGURE 108. READ SEQUENCE (SLAVE ADDRESS SHOWN AS nnnnnn)

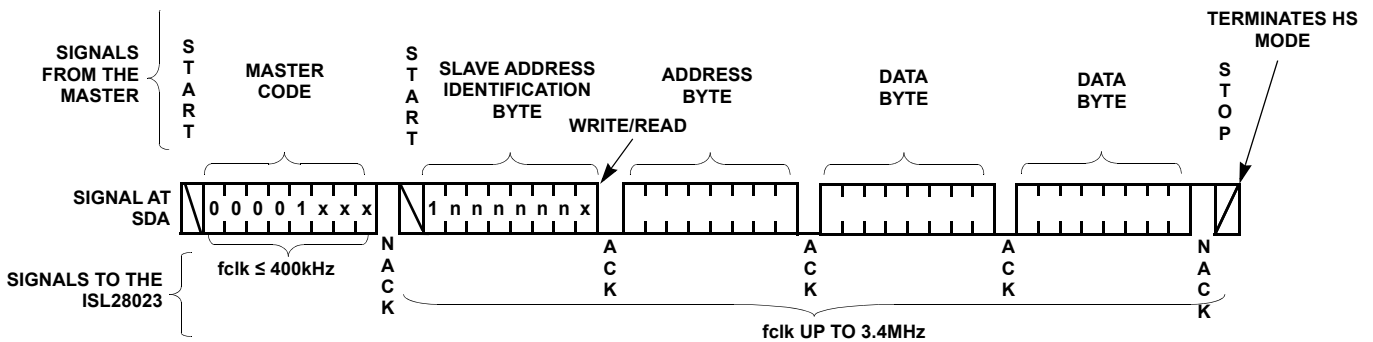

FIGURE 109. BYTE TRANSACTION SEQUENCE FOR INITIATING DATA RATES ABOVE 400kbs

## Clock Speed

The device supports high-speed digital transactions up to 3.4Mbps. To access the high speed I<sup>2</sup>C feature, a master byte code of 0000 1xxx is attached to the beginning of a standard frequency read/write I<sup>2</sup>C protocol. The x in the master byte signifies a “Do not care state”. X can either equal a 0 or a 1. The master byte code should be clocked into the chip at frequencies equal or less than 400kHz. The master code command configures the internal filters of the ISL28023 to permit data bit frequencies greater than 400kHz. Once the master code has been clocked into the device, the protocol for a standard read/write transaction is followed. The frequency at which the standard protocol is clocked in at can be as great as 3.4MHz. A stop bit at the end of a standard protocol will terminate the high speed transaction mode. Appending another standard protocol serial transaction to the data string without a stop bit, will resume the high speed digital transaction mode. [Figure 109](#) illustrates the data sequence for the high speed mode. The minimum I<sup>2</sup>C supply voltage when operating at clock speeds of 400kHz is 1.8V.

## Signal Integrity

The purity of the signal being measured by the ISL28023 is not always ideal. Environmental noise or noise generated from a regulator can degrade the measurement accuracy. The ISL28023 maintains a high CMRR ratio from DC to approximately 10kHz, as shown in [Figure 110](#).

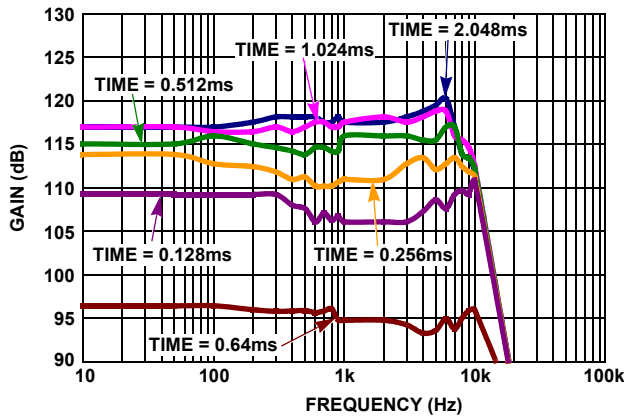

FIGURE 110. CMRR vs FREQUENCY

The CMRR vs Frequency graph best represents the response of the ISL28023 when an aberrant signal is applied to the circuit.

The graph was generated by shorting the ISL28023 V<sub>SHUNT</sub> inputs without any filtering and applying a 0V to 20V sine wave to the shunt inputs, VINP and VINM. A 0V to 3V sine wave was applied to the auxiliary V<sub>SHUNT</sub> inputs, AuxP and AuxM. The voltage range from a 1024 sample set was recorded for each frequency applied to shunt input. CMRR results prior to 10kHz are mostly a result of the variability of the measurement due to the programmed acquisition time. The input is not able to bleed through the noise floor.

The CMRR can be improved by designing a filter stage before the ISL28023. The purpose of the filter stage is to attenuate the amplitude of the unwanted signal to the noise level of the

ISL28023. [Figure 111](#) is a simple filter example to attenuate unwanted signals.

Measuring large currents requires low value sense resistors. A large valued capacitor is required to filter low frequencies if the shunt capacitor, C<sub>SH</sub> is connected directly in parallel to the sense resistor, R<sub>SH</sub>. For more manageable capacitor values, it may be better to directly connect the shunt resistor across the shunt inputs of the ISL28023. The connection is illustrated in [Figure 111](#). A single pole filter constructed of 2 resistors, R<sub>1</sub>, and C<sub>SH</sub> will improve capacitor value selections for low frequency filtering.

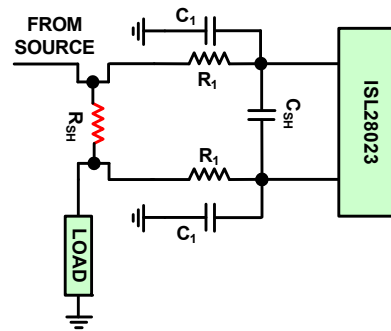

FIGURE 111. SIMPLIFIED FILTER DESIGN TO IMPROVE NOISE PERFORMANCE TO THE ISL28023

R<sub>1</sub> and C<sub>1</sub> at both shunt inputs are single ended low pass filters. The value of the series resistor to the ISL28023 can be a larger value than the shunt resistor, R<sub>SH</sub>. A larger series resistor to the input allows for a lower cutoff frequency filter design to the ISL28023. The ISL28023 inputs can source up to 20μA of transient current in the measurement mode. The transient or switching offset current can be as large as 10μA. The switching offset current combined with the series resistance, R<sub>1</sub>, creates an error offset voltage. A balance of the value of R<sub>1</sub> and the shunt measurement error should be achieved for this filter design.

The common-mode voltage of the shunt input stage ranges from 0V to 60V. The capacitor voltage rating for C<sub>1</sub> and C<sub>SH</sub> should comply with the nominal voltage being applied to the input.

## Fast Transients

A small isolation resistor placed between ISL28023 inputs and the source is recommended. In hot swap or other fast transient events, the amplitude of a signal can exceed the recommended operating voltage of the part due to the line inductance. The isolation resistor creates a low pass filter between the device and the source. The value of the isolation resistor should not be too large. A large value isolation resistor can effect the measurement accuracy. The value of the isolation resistor combined with the offset current creates an offset voltage error at the shunt input. The input of the Bus channel is connected to the top of a precision resistor divider. The accuracy of the resistor divider determines the gain error of the Bus channel. The input resistance of the Bus channel is 600kΩ. Placing an isolation resistor of 10Ω will change the gain error of the Bus channel by 0.0016%.

**External Clock**

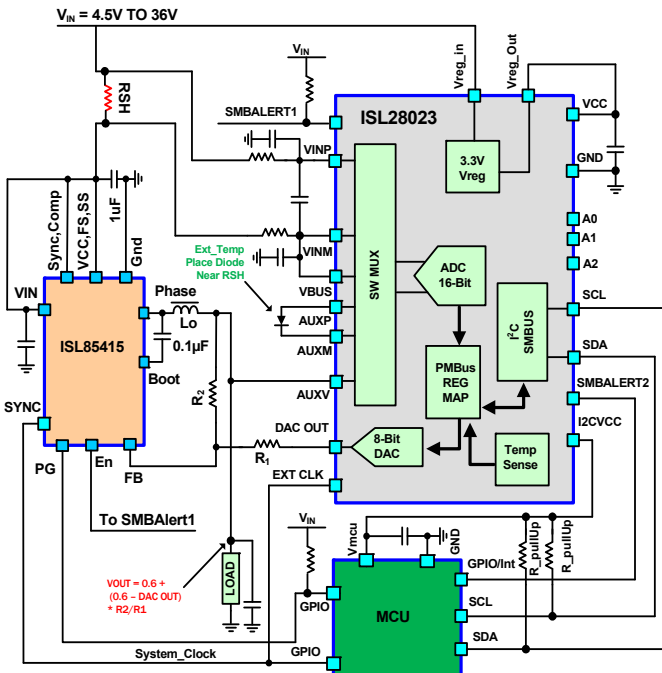
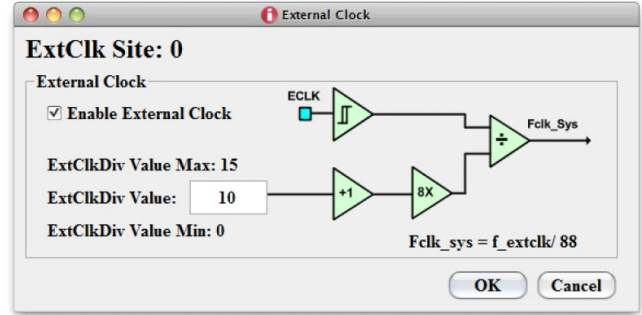

**FIGURE 112. SIMPLIFIED SCHEMATIC OF THE ISL28023 SYNCHRONIZED TO A MCU SYSTEM CLOCK**

An externally controlled clock allows measurements to be synchronized to an event that is time dependent. The event could be application generated, such as timing a current measurement to a charging capacitor in a switch regulator application or the event could be environmental. A voltage or current measurement may be susceptible to crosstalk from a controlled source. Instead of filtering the environmental noise from the measurement, another approach would be to synchronize the measurement to the source. The variability and accuracy of the measurement will improve.

The ISL28023 has the functionality to allow for synchronization to an external clock. The speed of the external clock combined with the choice of the internal chip frequency division value determines the acquisition times of the ADC. The internal system clock frequency is 500kHz. The internal system clock is also the ADC sampling clock. The acquisition times scale linearly from 500kHz. For example, an external clock frequency of 4.0MHz with a frequency divide setting of 0 (internal divide by 8) results in acquisition times that equal the internal oscillator frequency when enabled. The ADC modulator is optimized for frequencies of 500kHz. Operating internal clock frequencies beyond 500kHz may result in measurement accuracy errors due to the modulator not having enough time to settle.

Suppose an external clock frequency of 5.5MHz is applied with a divide by 88 internal frequency setting, the system clock speed is 62.5kHz or 8x slower than the internal system clock. The acquisition times for this example will increase by 8. For a channel's conversion time setting of 2.048ms, the ISL28023 will have an acquisition time of 256µs.



**FIGURE 113. EXTERNAL CLOCK MODE**

Figure 113 illustrates a simple mathematical diagram of the ECLK pin internal connection. The external clock divide is controlled by way of the EXTCLKDIV bit in register 0xE5.

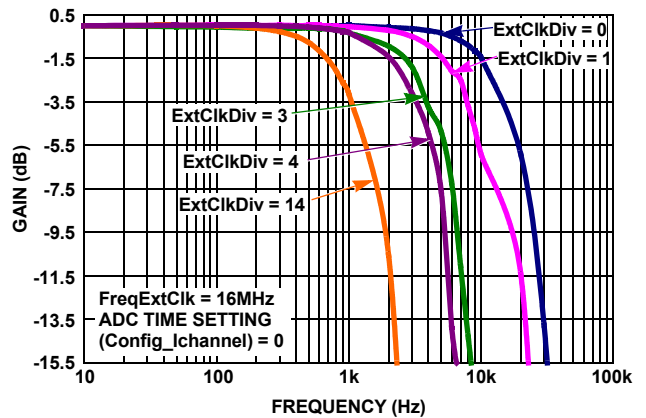
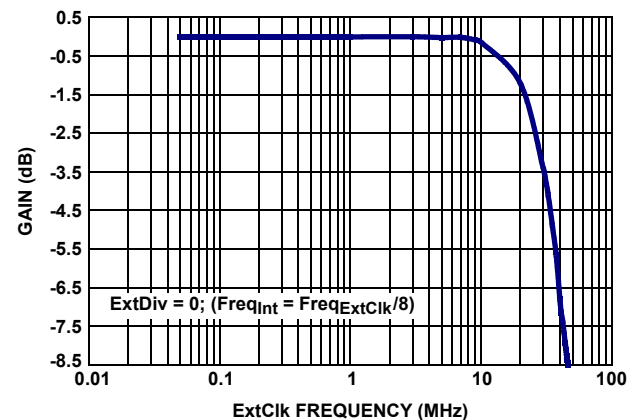

**FIGURE 114. MEASUREMENT BANDWIDTH vs EXTERNAL CLK FREQUENCY**

Figure 114 illustrates how changing the system clock frequency effects the measurement bandwidth (the ADC acquisition time).

The bandwidth of the external clock circuitry is 25MHz.

Figure 115 shows the bandwidth of the external clock circuitry when the external clock division bits equals to 0.



**FIGURE 115. EXTERNAL CLOCK BANDWIDTH vs MEASUREMENT ACCURACY**



The external clock pin can accept signal frequencies above 25MHz by programming the system clock frequency such that the internal clock frequency is below 25MHz.

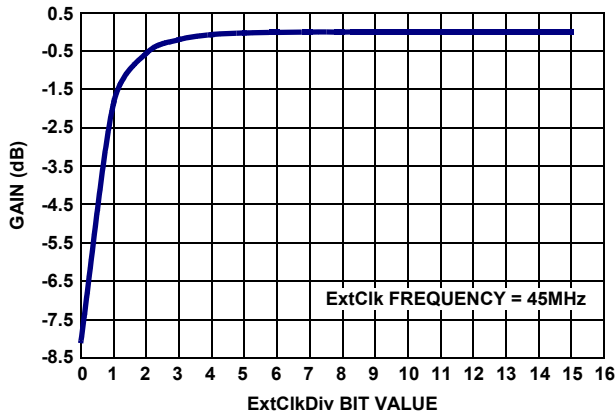

FIGURE 116. EXTERNAL CLOCK vs EXTERNAL BIT VALUE

Figure 116 illustrates the effects of dividing the external clock frequency on the  $V_{SHUNT}$  measurement accuracy.

Figures 115 and 116 were generated by applying a DC voltage to the  $V_{SHUNT}$  input and measuring the signal by way of an ADC conversion.

## Overranging

It is not recommended to operate the ISL28023 outside the set voltage range. In the event of measuring a shunt voltage beyond the maximum set range (80mV) and lower than the clamp voltage of the protection diode (1V), the measured output reading may be within the accepted range but will be incorrect.

## Shunt Resistor Selection

In choosing a sense resistor, the following resistor parameters need to be considered: the resistor value, resistor temperature coefficient and resistor power rating.

The sense resistor value is a function of the full-scale voltage drop across the shunt resistor and the maximum current measured for the application. The maximum measurable range for the  $V_{SHUNT}$  input (VINP-VINM) of the ISL28023 is 80mV. The ISL28023 allows the user to define a unique range other than  $\pm 80$ mV.

Once the voltage range for the input is chosen and the maximum measurable current is known, the sense resistor value is calculated using Equation 19.

$$R_{sense} = \frac{V_{shunt\_range}}{I_{meas\_Max}} \quad (EQ. 19)$$

In choosing a sense resistor, the sense resistor power rating should be taken into consideration. The physical size of a sense resistor is proportional to the power rating of the resistor. The maximum power rating for the measurement system is calculated as the  $V_{shunt\_range}$  multiplied by the maximum

measurable current expected. The power rating equation is represented in Equation 20.

$$P_{res\_rating} = V_{shunt\_range} \cdot I_{meas\_Max} \quad (EQ. 20)$$

A general rule of thumb is to multiply the power rating calculated in Equation 20 by 2. This allows the sense resistor to survive an event when the current passing through the shunt resistor is greater than the measurable maximum current. The higher the ratio between the power rating of the chosen sense resistor and the calculated power rating of the system (Equation 20), the less the resistor will heat up in high current applications.

The Temperature Coefficient (TC) of the sense resistor directly degrades the current measurement accuracy. The surrounding temperature of the sense resistor and the power dissipated by the resistor will cause the sense resistor value to change. The change in resistor temperature with respect to the amount of current that flows through the resistor is directly proportional to the ratio of the power rating of the resistor versus the power being dissipated. A change in sense resistor temperature results in a change in sense resistor value. Overall, the change in sense resistor value contributes to the measurement accuracy for the system. The change in a resistor value due to a temperature rise can be calculated using Equation 21.

$$\Delta R_{sense} = R_{sense} \cdot R_{sense\_TC} \cdot \Delta Temperature \quad (EQ. 21)$$

$\Delta Temperature$  is the change in temperature in Celsius.  $R_{sense\_TC}$  is the temperature coefficient rating for a sense resistor.  $R_{sense}$  is the resistance value of the sense resistor at the initial temperature.

Table 50 is a shunt resistor look up table for select full-scale current measurement ranges ( $I_{meas\_Max}$ ). Table 50 also provides the minimum rating for each shunt resistor.

TABLE 50. SHUNT RESISTOR VALUES AND POWER RATINGS FOR SELECT MEASURABLE CURRENT RANGES

RSENSE/P/RATING	VSHUNT RANGE (PGA SETTING)
$I_{meas\_Max}$	80mV
100 $\mu$ A	800 $\Omega$ /8 $\mu$ W
1mA	80 $\Omega$ /80 $\mu$ W
10mA	8 $\Omega$ /800 $\mu$ W
100mA	800m $\Omega$ /8mW
500mA	160m $\Omega$ /40mW
1A	80m $\Omega$ /80mW
5A	16m $\Omega$ /400mW
10A	8m $\Omega$ /800mW
50A	1.6m $\Omega$ /4W
100A	0.8m $\Omega$ /8W
500A	0.16m $\Omega$ /40W

It is often hard to readily purchase shunt resistor values for a desired measurable current range. Either the value of the shunt resistor does not exist or the power rating of the shunt resistor is too low. A means of circumventing the problem is to use two or

more shunt resistors in parallel to set the desired current measurement range. For example, an application requires a full-scale current of 100A with a maximum voltage drop across the shunt resistor of 80mV. From [Table 50](#), this requires a sense resistor of 0.8mΩ, 8W resistor. Assume the power ratings and the shunt resistor values to chose from are 1mΩ/4W, 2mΩ/4W and 4mΩ/4W.

Let's use a 1mΩ and a 4mΩ resistor in parallel to create the shunt resistor value of 0.8mΩ. [Figure 117](#) shows an illustration of the shunt resistors in parallel.

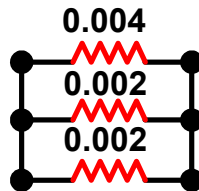

**FIGURE 117. A SIMPLIFIED SCHEMATIC ILLUSTRATING THE USE OF TWO SHUNT RESISTORS TO CREATE A DESIRED SHUNT VALUE**

The power to each shunt resistor should be calculated before calling a solution complete. The power to each shunt resistor is calculated using [Equation 22](#).

$$P_{\text{shuntRes}} = \frac{V_{\text{shunt\_range}}^2}{R_{\text{sense}}} \quad (\text{EQ. 22})$$

The power dissipated by the 1mΩ resistor is 6.4W. 1.6W is dissipated by the 4mΩ resistor. 1.6W exceeds the rating limit of 1W for the 1mΩ sense resistor. Another approach would be to use three shunt resistors in parallel as illustrated in [Figure 118](#).



**FIGURE 118. INCREASING THE NUMBER OF SHUNT RESISTORS IN PARALLEL TO CREATE A SHUNT RESISTOR VALUE REDUCES THE POWER DISSIPATED BY EACH SHUNT RESISTOR.**

Using [Equation 22](#), the power dissipated to each shunt resistor yields 3.2W for the 2mΩ shunt resistors and 1.6W for the 4mΩ

$$V_c(F) = \left[ \frac{(j \cdot \omega(f) \cdot L + R_{\text{dcr}})}{1 + j \cdot \omega(f) \cdot C_{\text{sen}} \cdot R_{\text{sen}}} \right] \cdot I_L = R_{\text{dcr}} \cdot \left[ \frac{\left[ 1 + \frac{(j \cdot \omega(f) \cdot L)}{R_{\text{dcr}}} \right]}{1 + j \cdot \omega(f) \cdot C_{\text{sen}} \cdot R_{\text{sen}}} \right] \cdot I_L \quad (\text{EQ. 25})$$

shunt resistor. All shunt resistors are within the specified power ratings.

## Lossless Current Sensing (DCR)

A DCR sense circuit is an alternative to a sense resistor. The DCR circuit utilizes the parasitic resistance of an inductor to measure the current to the load. A DCR circuit remotely measures the current through an inductor. The lack of components in series with the regulator to the load makes the circuit lossless.

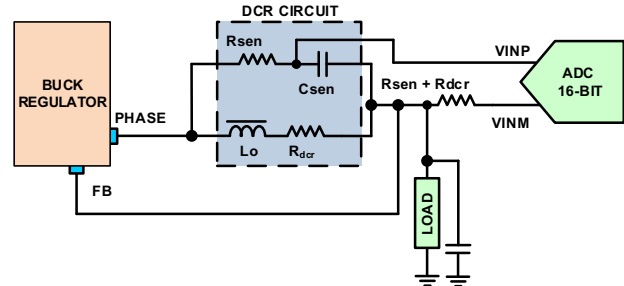

**FIGURE 119. A SIMPLIFIED CIRCUIT EXAMPLE OF A DCR**

A properly matched DCR circuit has an equivalent circuit seen by the ADC equals to  $R_{\text{dcr}}$  in [Figure 119](#). Before deriving the transfer function between the inductor current and voltage seen by the ISL28023, let's review the definition of an inductor and capacitor in the Laplacian domain.

$$X_c(f) = \frac{1}{j \cdot \omega(f) \cdot C} \quad X_L(f) = j \cdot \omega(f) \cdot L \quad (\text{EQ. 23})$$

$X_c$  is the impedance of a capacitor related to the frequency and  $X_L$  is the impedance of an inductor related to frequency.  $\omega$  equals to  $2\pi f$ .  $f$  is the chop frequency dictated by the regulator. Using Ohms law, the voltage across the DCR circuit in terms of the current flowing through the inductor is defined in [Equation 24](#).

$$V_{\text{dcr}}(f) = (R_{\text{dcr}} + j \cdot \omega(f) \cdot L) \cdot i_L \quad (\text{EQ. 24})$$

In [Equation 24](#),  $R_{\text{dcr}}$  is the parasitic resistance of the inductor. The voltage drop across the inductor ( $L_o$ ) and the resistor ( $R_{\text{dcr}}$ ) circuit is the same as the voltage drop across the resistor ( $R_{\text{sen}}$ ) and the capacitor ( $C_{\text{sen}}$ ) circuit. [Equation 25](#) defines the voltage across the capacitor ( $V_{\text{cSEN}}$ ) in terms of the inductor current ( $I_L$ ).

The relationship between the inductor load current ( $I_L$ ) and the voltage across the capacitor simplifies if the following component selection holds true;

$$\frac{L}{R_{dcr}} = C_{sen} \cdot R_{sen} \quad (\text{EQ. 26})$$

If [Equation 26](#) holds true, the numerator and denominator of the fraction in [Equation 25](#) cancels reducing the voltage across the capacitor to the equation represented in [Equation 27](#).

$$V_c = R_{dcr} \cdot i_L \quad (\text{EQ. 27})$$

Most inductor datasheets will specify the average value of the  $R_{dcr}$  for the inductor.  $R_{dcr}$  values are usually sub  $1\text{m}\Omega$  with a tolerance averaging 8%. Common chip capacitor tolerances average to 10%.

Inductors are constructed out of metal. Metal has a high temperature coefficient. The temperature drift of the inductor value could cause the DCR circuit to be untuned. An untuned circuit results in inaccurate current measurements along with a chop signal bleeding into the measurement. To counter the temperature variance, a temperature sensor may be incorporated into the design to track the change in component values.

A DCR circuit is good for gross current measurements. As discussed, inductors and capacitors have high tolerances and are temperature dependent which will result in less than accurate current measurements.

In [Figure 119](#), there is a resistor in series with the ISL28023 negative shunt terminal, VINM, with the value of  $R_{sen} + R_{dcr}$ . The resistor's purpose is to counter the effects of the bias current from creating a voltage offset at the input of the ADC.

## Layout

The layout of a current measuring system is equally important as choosing the correct sense resistor and the correct analog converter. Poor layout techniques can result in severed traces, signal path oscillations, magnetic contamination, which all contribute to poor system performance.

### TRACE WIDTH

Matching the current carrying density of a copper trace with the maximum current that will pass through is critical in the performance of the system. Neglecting the current carrying capability of a trace will result in a large temperature rise in the trace, and the loss in system efficiency due to the increase in resistance of the copper trace. In extreme cases, the copper trace could be severed because the trace could not pass the current. The current carrying capability of a trace is calculated using [Equation 28](#).

$$\text{Trace width} = \frac{\left( \frac{I_{max}}{k \cdot \Delta T} \right)^{0.725}}{\text{Trace Thickness}} \quad (\text{EQ. 28})$$

$I_{max}$  is the largest current expected to pass through the trace.  $\Delta T$  is the allowable temperature rise in Celsius when the maximum

current passes through the trace.  $\text{Trace}_{\text{Thickness}}$  is the thickness of the trace specified to the PCB fabricator in mils. A typical thickness for general current carrying applications ( $<100\text{mA}$ ) is 0.5oz copper or 0.7mils. For larger currents, the trace thickness should be greater than 1.0oz or 1.4mils. A balance between thickness, width and cost needs to be achieved for each design. The coefficient  $k$  in [Equation 28](#) changes depending on the trace location. For external traces, the value of  $k$  equals 0.048 while for internal traces the value of  $k$  reduces to 0.024. The  $k$  values and [Equation 28](#) are stated per the ANSI IPC-2221(A) standards.

### TRACE ROUTING

It is always advised to make the distance between voltage source, sense resistor and load as close as possible. The longer the trace length between components will result in voltage drops between components. The additional resistance will reduce the efficiency of a system.

The bulk resistance,  $\rho$ , of copper is  $0.67\mu\Omega/\text{in}$  or  $1.7\mu\Omega/\text{cm}$  at  $+25^\circ\text{C}$ . The resistance of trace can be calculated from [Equation 29](#).

$$R_{\text{trace}} = \rho \cdot \frac{\text{Trace length}}{\text{Trace width} \cdot \text{Trace thickness}} \quad (\text{EQ. 29})$$

[Figure 120](#) illustrates each dimension of a trace.

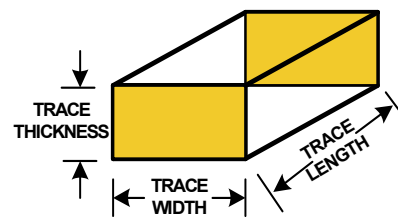

FIGURE 120. ILLUSTRATION OF THE TRACE DIMENSIONS FOR A STRIP LINE TRACE

For example, assume a trace has 2oz of copper or 2.8mil thickness, a width of 100mil and a length of 0.5in. Using [Equation 29](#), the resistance of the trace is approximately  $2\text{m}\Omega$ . Assume 1A of current is passing through the trace. A 2mV voltage drop would result from trace routing.

Current flowing through a conductor will take the path of least resistance. When routing a trace, avoid orthogonal connections for current bearing traces.

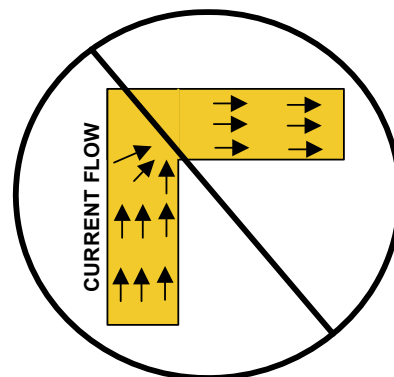
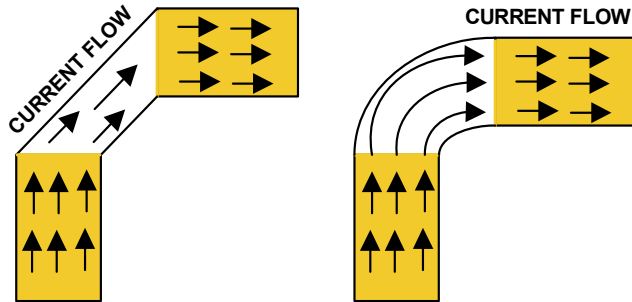

FIGURE 121. AVOID ROUTING ORTHOGONAL CONNECTIONS FOR TRACES THAT HAVE HIGH CURRENT FLOWS

Orthogonal routing for high current flow traces will result in current crowding, localized heating of the trace and a change in trace resistance.

The utilization of arcs and 45° traces in routing large current flow traces will maintain uniform current flow throughout the trace.

[Figure 122](#) illustrates the routing technique.



**FIGURE 122. USE ARCS AND 45 DEGREE TRACES TO SAFELY ROUTE TRACES WITH LARGE CURRENT FLOWS**

### CONNECTING SENSE TRACES TO THE CURRENT SENSE RESISTOR

Ideally, a 4-terminal current sense resistor would be used as the sensing element. Four terminal sensor resistors can be hard to find in specific values and in sizes. Often a two terminal sense resistor is designed into the application.

Sense lines are high impedance by definition. The connection point of a high impedance line reflects the voltage at the intersection of a current bearing trace and a high impedance trace.

The high impedance trace should connect at the intersection where the sense resistor meets the landing pad on the PCB. The best place to make current sense line connection is on the inner side of the sense resistor footprint. The illustration of the connection is shown in [Figure 123](#). Most of the current flow is at the outer edge of the footprint. The current ceases at the point the sense resistor connects to the landing pad. Assume the sense resistor connects at the middle of each landing pad, this leaves the inner half of each landing pad with little current flow. With little current flow, the inner half of each landing pad is classified as high impedance and perfect for a sense connection.

Current sense resistors are often smaller than the width of the traces that connect to the footprint. The trace connecting to the footprint is tapered at a 45° angle to control the uniformity of the current flow.

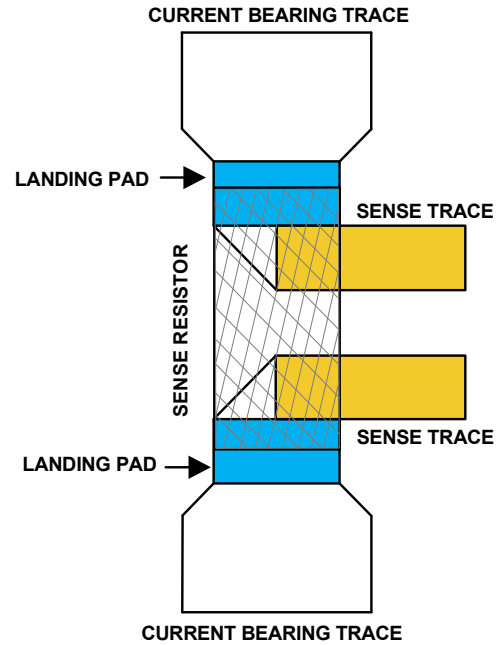

**FIGURE 123. CONNECTING THE SENSE LINES TO A CURRENT SENSE RESISTOR**

### MAGNETIC INTERFERENCE

The magnetic field generated from a trace is directly proportional to the current passing through the trace and the distance from the trace the field is being measured at. [Figure 124](#) illustrates the direction the magnetic field flows versus current flow.

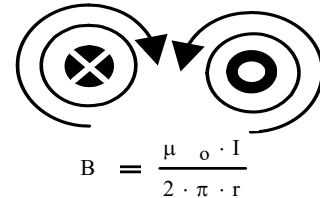

$$B = \frac{\mu_o \cdot I}{2 \cdot \pi \cdot r}$$

**FIGURE 124. THE CONDUCTOR ON THE LEFT SHOWS THE MAGNETIC FIELD FLOWING IN A CLOCKWISE DIRECTION FOR A CURRENT FLOWING INTO THE PAGE. A CURRENT FLOW OUT OF THE PAGE HAS A COUNTERCLOCKWISE MAGNETIC FLOW**

The equation in [Figure 124](#) determines the magnetic field, B, the trace generates in relation to the current passing through the trace, I, and the distance the magnetic field is being measured from the conductor, r. The permeability of air,  $\mu_o$ , is  $4\pi \cdot 10^{-7}$  H/m.

When routing high current traces, avoid routing high impedance traces in parallel with high current bearing traces. A means of limiting the magnetic interference from high current traces is to closely route the paths connected to and from the sense resistor. The magnetic fields will cancel outside the two traces and add between the two traces. [Figure 125](#) illustrates a magnetic field insensitive layout.

If possible, do not cross traces with high current. If a trace crossing cannot be avoided, cross the trace in an orthogonal manner and the furthest layer from the current bearing trace. The interference from the current bearing trace will be limited.

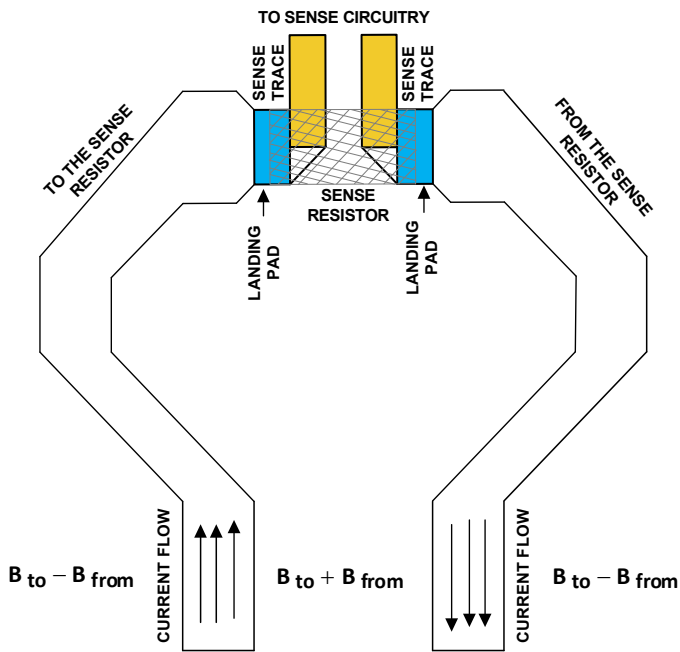

**FIGURE 125. CLOSELY ROUTED TRACES THAT CONNECT TO THE SENSE RESISTOR REDUCES THE MAGNETIC INTERFERENCE SOURCED FROM THE CURRENT FLOWING THROUGH THE TRACES**

**A Trace as a Sense Resistor**

In previous sections, the resistance and the current carrying capabilities of a trace were discussed. In high current sense applications, a design may utilize the resistivity of a current sense trace as the sense resistor. This section will discuss how to design a sense resistor from a copper trace.

Suppose an application needs to measure current up to 200A. The design requires the least amount of voltage drop for maximum efficiency. The full-scale voltage range of 40mV is chosen. From Ohms law, the sense resistor is calculated to be 200μΩ. The power rating of the resistor is calculated to be 8W. Assume the PCB trace thickness of the board equals 2oz/2.8mils and the maximum temperature rise of the trace is 20°C. Using Equation 28, the calculated trace width is 2.192in. The trace width, thickness and the desired sense resistor value is known. Utilizing Equation 29, the trace length is calculated to be 1.832in.

Figure 126 illustrates a layout example of a current sense resistor defined by a PCB trace. The serpentine pattern of the resistor reduces current crowding as well as limiting the magnetic interference caused by the current flowing through the trace.

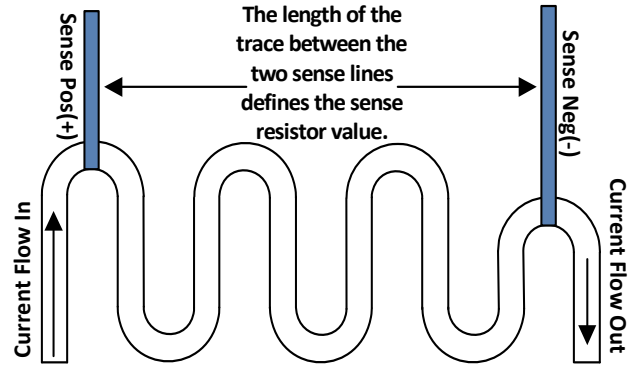
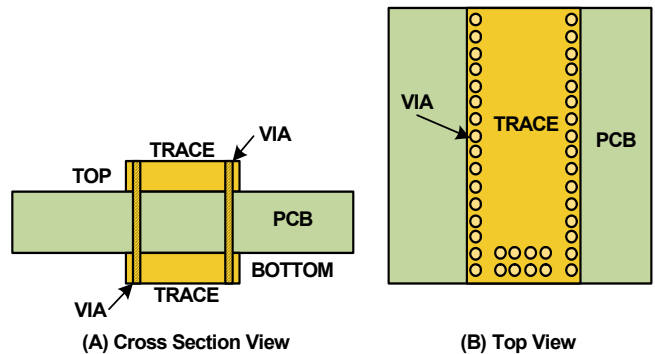

**FIGURE 126. ILLUSTRATES A LAYOUT EXAMPLE OF A CURRENT SENSE RESISTOR MADE FROM A PCB TRACE**

For the example discussed, the width of the trace in Figure 126 illustration would equal 2.192in and the length between the sense lines equals 1.832in.

The width of the resistor is long for some applications. A means of shortening the trace width is to connect two traces in parallel. For calculation ease, assume the resistive traces are routed on the outside layers of a PCB. Using Equations 28 and 29, the width of the trace is reduced from 2.192in to 1.096in.

When using multiple layers to create a trace resistor, use multiple vias to keep the trace potentials between the two conductors the same. Vias are highly resistive compared to a copper trace. Multiple vias should be employed to lower the voltage drop due to current flowing through resistive vias. Figure 127 illustrates a layout technique for a multiple layered trace sense resistor.



**FIGURE 127. LAYOUT EXAMPLE OF A MULTIPLE LAYER TRACE RESISTOR**

## Revision History

The revision history provided is for informational purposes only and is believed to be accurate, but not warranted. Please go to the web to make sure that you have the latest revision.

DATE	REVISION	CHANGE
Jun 13, 2022	6.02	Corrected the typo on page 8 in the EC table changing part from ISL28025 to ISL28023.
Feb 22, 2022	6.01	Removed Related Literature section. Updated the ordering information table formatting. Updated Device ID in Table 2 to 0849534C3238303233.
Jul 30, 2020	6.00	Updated links throughout. Updated Related Literature section. Updated Ordering information table by adding tape and reel qty column and updating notes. Updated Function description in Table 2 on page 29 for 8D. Removed About Intersil section
Mar 18, 2016	5.00	Updated Related Literature on page 1. Ordering information on page 3: Updated Note 1 to include units. Changed the Polarity of the CNVR bit from High to Low when the ADC is making a conversion. See section "CNVR: Conversion Ready D[1]" on page 33. In Figure 109 on page 46, added an ACK to the diagram before the repeat start. Updated Figures 106 and 108.
Jun 17, 2015	4.00	Add Related Literature section to page 1. Added DPM Portfolio Comparison table on page 5. Removed Typical Applications section (which included Figures 127 through 135) and made into an appnote (AN1955).
Oct 27, 2014	3.00	On <a href="#">page 37</a> VBUS_OV_OT_SET [1st Paragraph) changed the step size to 5.71 and added a sentence. Added a column to the <a href="#">Table 24</a> . Changed the table title on <a href="#">Table 30</a> to Vshunt_OC_Set ( <a href="#">page 38</a> )
Jun 27, 2014	2.00	Removed ISL28023EVAL2Z information and added ISL28023EVKIT1Z (Evaluation Kit) to the Ordering Information on <a href="#">page 3</a> .
Jun 12, 2014	1.00	Changed AUXN to AUXM in <a href="#">Figures 1, 112, 127, 128, 129, 131, 132, 133, and 135</a> . Updated <a href="#">Notes 4 and 5</a> to correct package notes required. <a href="#">Page 51</a> the equation reference of 15 becomes 28 <a href="#">Figure 120</a> changed "OF A STRIP" to "FOR A STRIP" in the title. <a href="#">Figure 124</a> changed "CURRENT FLOW OUT" to "A CURRENT FLOW OUT" in the title. <a href="#">Equation 25</a> was updated by adding " I <sub>L</sub> " to the first portion of equation. Added evaluation board information to Ordering Information on <a href="#">page 3</a> .
May 2, 2014	0.00	Initial Release.

# Package Outline Drawing

For the most recent package outline drawing, see [L24.4x4D](#).

L24.4x4D

24 Lead Quad Flat No-Lead Plastic Package

Rev 3, 11/13

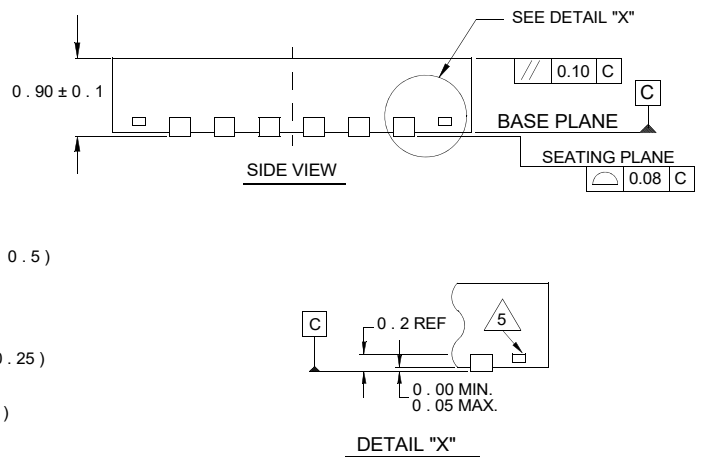
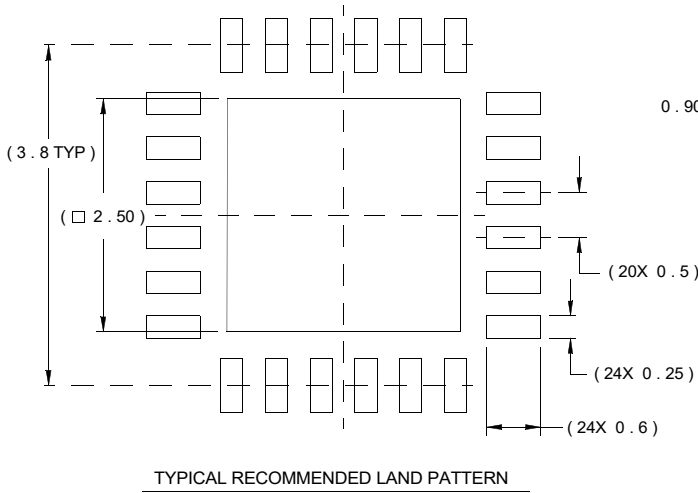
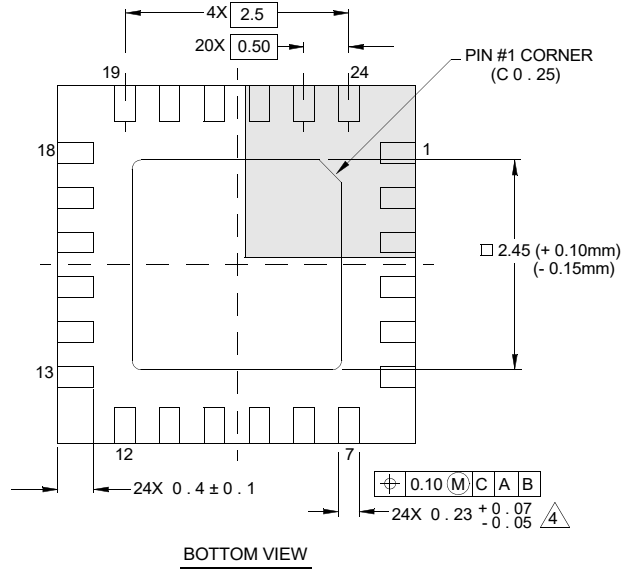
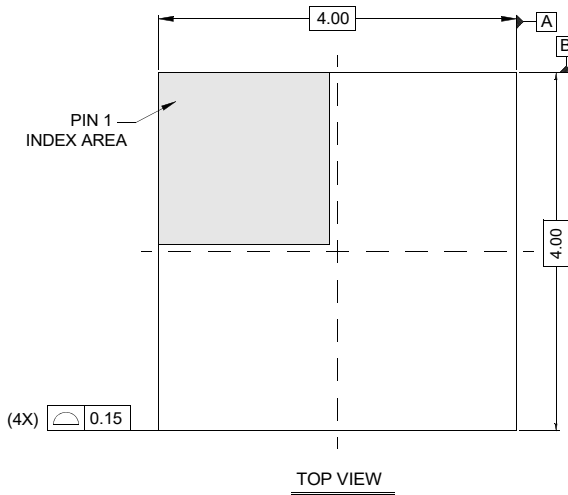

NOTES:

1. Dimensions are in millimeters.  
Dimensions in ( ) for Reference Only.
2. Dimensioning and tolerancing conform to AMSE Y14.5m-1994.
3. Unless otherwise specified, tolerance : Decimal  $\pm 0.05$
4. Dimension b applies to the metallized terminal and is measured between 0.15mm and 0.30mm from the terminal tip.
5. Tiebar shown (if present) is a non-functional feature.
6. The configuration of the pin #1 identifier is optional, but must be located within the zone indicated. The pin #1 identifier may be either a mold or mark feature.

## IMPORTANT NOTICE AND DISCLAIMER

RENESAS ELECTRONICS CORPORATION AND ITS SUBSIDIARIES (“RENESAS”) PROVIDES TECHNICAL SPECIFICATIONS AND RELIABILITY DATA (INCLUDING DATASHEETS), DESIGN RESOURCES (INCLUDING REFERENCE DESIGNS), APPLICATION OR OTHER DESIGN ADVICE, WEB TOOLS, SAFETY INFORMATION, AND OTHER RESOURCES “AS IS” AND WITH ALL FAULTS, AND DISCLAIMS ALL WARRANTIES, EXPRESS OR IMPLIED, INCLUDING, WITHOUT LIMITATION, ANY IMPLIED WARRANTIES OF MERCHANTABILITY, FITNESS FOR A PARTICULAR PURPOSE, OR NON-INFRINGEMENT OF THIRD PARTY INTELLECTUAL PROPERTY RIGHTS.

These resources are intended for developers skilled in the art designing with Renesas products. You are solely responsible for (1) selecting the appropriate products for your application, (2) designing, validating, and testing your application, and (3) ensuring your application meets applicable standards, and any other safety, security, or other requirements. These resources are subject to change without notice. Renesas grants you permission to use these resources only for development of an application that uses Renesas products. Other reproduction or use of these resources is strictly prohibited. No license is granted to any other Renesas intellectual property or to any third party intellectual property. Renesas disclaims responsibility for, and you will fully indemnify Renesas and its representatives against, any claims, damages, costs, losses, or liabilities arising out of your use of these resources. Renesas' products are provided only subject to Renesas' Terms and Conditions of Sale or other applicable terms agreed to in writing. No use of any Renesas resources expands or otherwise alters any applicable warranties or warranty disclaimers for these products.

(Rev.1.0 Mar 2020)

### Corporate Headquarters

TOYOSU FORESIA, 3-2-24 Toyosu,  
Koto-ku, Tokyo 135-0061, Japan  
[www.renesas.com](http://www.renesas.com)

### Contact Information

For further information on a product, technology, the most up-to-date version of a document, or your nearest sales office, please visit:  
[www.renesas.com/contact/](http://www.renesas.com/contact/)

### Trademarks

Renesas and the Renesas logo are trademarks of Renesas Electronics Corporation. All trademarks and registered trademarks are the property of their respective owners.