

High-current EMC/RFI Filter

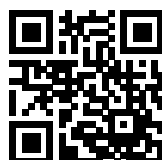

- Off-the-shelf high power filter for rated currents up to 2500 A
- HV versions applicable for IT power networks
- Busbars for convenient and universal electrical connection
- Protective plastic covers optionally available for unsurpassed safety



Performance indicators

Attenuation performance



Rated current [A]

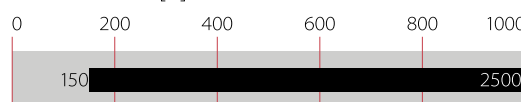

Technical Specifications

Maximum continuous operating voltage	3x 760/440 VAC (FN 3359 HV) 3x 520/300 VAC (FN 3359)
Operating frequency	DC to 60 Hz
Rated currents	150 to 2500 A @ 50°C
High potential test voltage	P → P 3270 VDC for 2 sec (FN 3359 HV) P → E 2750 VDC for 2 sec (FN 3359) P → P 2250 VDC for 2 sec (FN 3359) P → E 3200 VDC for 2 sec (FN 3359 HV)
Protection category	IP 00
Overload capability	4x rated current at switch on, 1.5x rated current for 1 minute, once per hour
Temperature range (operation and storage)	-25°C to +100°C (25/100/21)
Flammability corresponding to	UL 94 V-2 or better
Design corresponding to	UL 1283, CSA 22.2 No. 8 1986, IEC/EN 60939
MTBF @ 45°C/480 V (Mil-HB-217F)	130,000 hours

Approvals & Compliances



UL: 600/400 VAC for 1600A and 2500A @ 40°C ambient temp.; ENEC up to 1600A: 690/400 VAC

Features and Benefits

- High-power filter for Class A compliance. With approval measurement also Class B compliance possible for some applications
- Extremely compact high-current filter solution with minimum space requirement
- FN 3359 HV versions are applicable for IT power networks
- Optionally available transparent protective covers for all filters up to 1000 A, to protect the installer, operator or inspector from undeliberate touching of life conductors. They can easily be retrofitted even if the filter is already installed and connected
- FN 3359 also improves conducted immunity of installations

Typical Applications

- High-power motor drives, inverters and converters
- Industrial three-phase systems
- Entire factories, plants and installations
- Large UPS
- Machinery
- Mining equipment
- Photovoltaic systems with galvanic isolation*
- Wind turbines





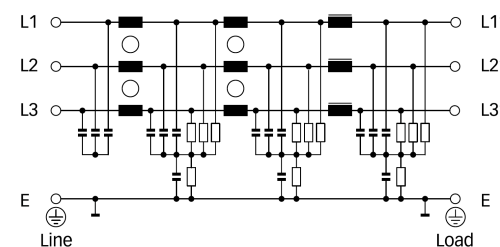

















* For EMI solutions for PV system without galvanic isolation, please contact your local Schaffner partner

Typical electrical schematic



Note: HV versions without discharge resistor to ground.

Filter Selection Table

Filter	Buy	Rated current	Typical drive	Leakage current**	Power loss	Input/Output connections		Weight	Protective covers***
		@ 50°C (40°C)	power rating*	@ 520/760 VAC/50 Hz	@ 25°C/50 Hz			[kg]	Order code
		[A]	[kW]	[mA]	[W]				
FN3359-150-28		150 (164)	75	5.1	24	-28		5.8	801917
FN3359-180-28		180 (197)	90	5.1	34	-28		5.8	801917
FN3359-250-28		250 (250****)	132	5.1	49	-28		9.0	801918
FN3359-320-99		320 (350)	160	5.1	19		-99	10.5	801919
FN3359-400-99		400 (438)	220	5.1	29		-99	10.5	801919
FN3359-600-99		600 (657)	315	5.1	44		-99	11.0	801920
FN3359-800-99		800 (876)	400	5.3	39		-99	20.0	806276
FN3359-1000-99		1000 (1095)	560	5.3	60		-99	20.0	806276
FN3359-1600-99		1600 (1600)	900	5.1	131		-99	27.0	n.a.
FN3359-2500-99		2500 (2500)	1320	5.1	300		-99	69.0	n.a.
FN3359HV-150-28		150 (164)	110	7.5	24	-28		6.0	801917
FN3359HV-180-28		180 (197)	132	7.5	34	-28		6.0	801917
FN3359HV-250-28		250 (250)	200	7.5	49	-28		9.5	801918
FN3359HV-320-99		320 (350)	250	7.5	19		-99	10.5	801919
FN3359HV-400-99		400 (438)	315	7.5	29		-99	10.5	801919
FN3359HV-600-99		600 (657)	500	7.5	44		-99	11.0	801920
FN3359HV-800-99		800 (876)	630	7.5	39		-99	21.0	806276
FN3359HV-1000-99		1000 (1095)	710	7.5	60		-99	21.0	806276
FN3359HV-1600-99		1600 (1600)	1320	7.5	131		-99	27.0	n.a.
FN3359HV-2500-99		2500 (2500)	2000	7.7	300		-99	69.0	n.a.

**** Calculated at rated current, 480 VAC (FN 3359)/690 VAC (FN 3359 HV) and cos phi=0.8. The exact value depends upon the efficiency of the drive, the motor and the entire

***** application.

**** Standardized calculated leakage current acc. IEC60939 under normal operating conditions (FN 3359 at 520 VAC and FN 3359 HV at 760 VAC).

**** Please contact your local Schaffner partner to order the optional protective covers with the order code in the table above (n.a.: not available)

**** For terminal type -28 the max. current is limited to 250A, therefore no uprating possible at lower temperatures.

Distribution Inventory

Up-to-date inventory levels for global distributors is available at

<https://products.schaffner.com/stock>

or via the QR code printed on the right side



Typical Filter Attenuation

Per CISPR 17; A=50 Ω/50 Ω sym; B=50 Ω/50 Ω asym; C=0.1 Ω/100 Ω sym; D=100 Ω/0.1 Ω sym

150 to 180 A types

250 to 600 A types

800 and 1000 A types

1600 and 2500 A types

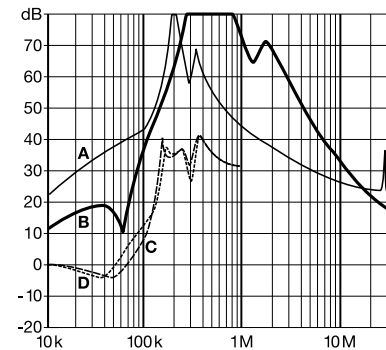
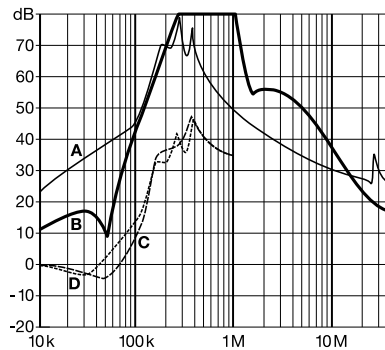
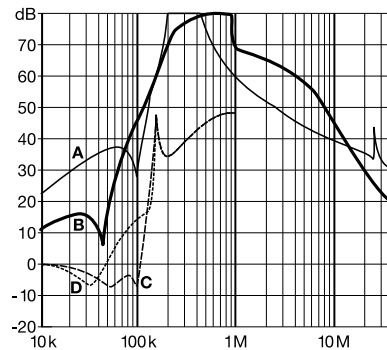
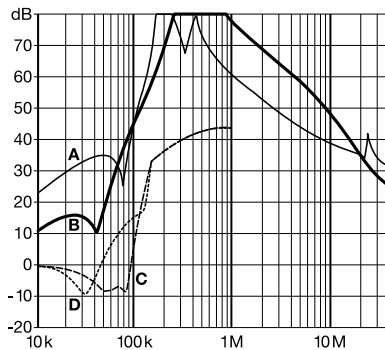

Mechanical Data

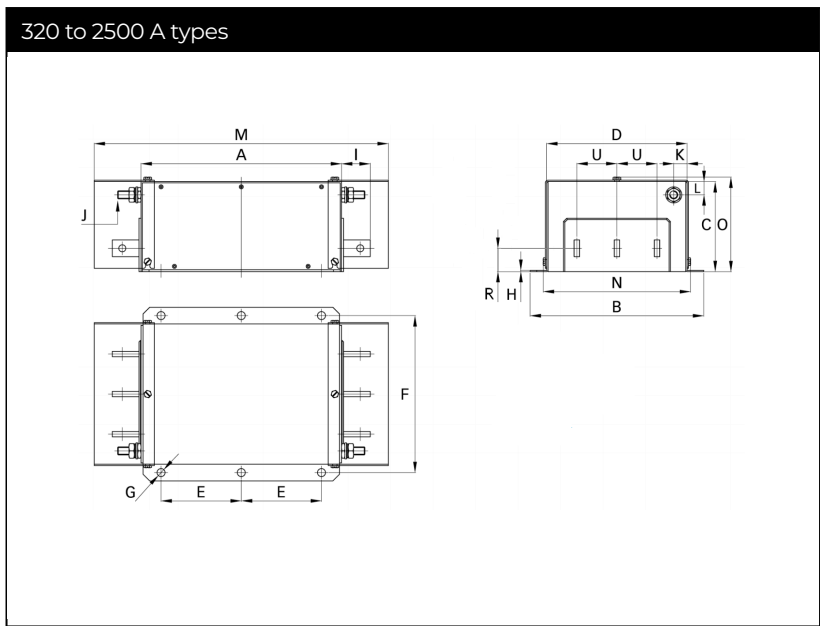
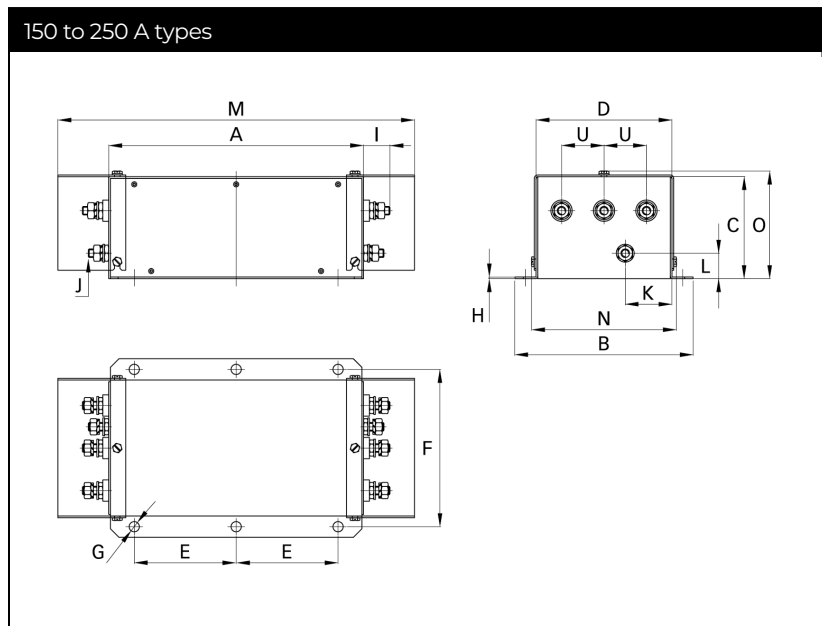

Busbar Connections

320 to 1000 A types

1600 A types

2500 A types

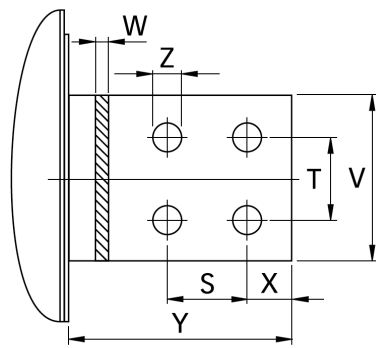
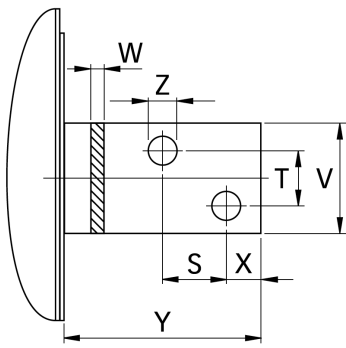
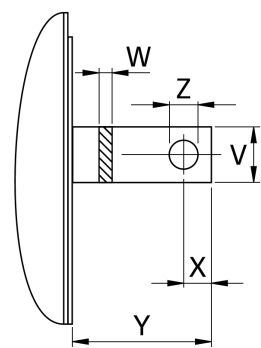

Dimensions

	150 A	180 A	250 A	320 A	400 A	600 A	800 A	1000 A	1600 A	2500 A
A	300	300	300	300	300	300	350	350	400	450
B	210	210	230	260	260	260	280	280	300	370
C	120	120	125	115	115	135	170	170	160	220
D	160	160	180	210	210	210	230	230	250	300
E	120	120	120	120	120	120	145	145	170	200
F	185	185	205	235	235	235	255	255	275	330
G	Ø12	Ø12	Ø12	Ø12	Ø12	Ø12	Ø12	Ø12	Ø12	Ø14
H	2	2	2	2	2	2	3	3	3	3
I	33	33	33	43	43	43	53	53	93	110
J	M10	M10	M10	M12	M12	M12	M12	M12	M12	M12
K	55	55	62.5	20	20	20	25	25	25	25
L	30	30	35	20	20	20	25	25	25	25
M	420	420	420	440	440	440	510	510	n.a.	n.a.
N	171	171	191	221	221	221	241	241	n.a.	n.a.
O	127	127	132	122	122	142	177	177	n.a.	n.a.
R				37	37	37	68	68	68	85
S									26	35
T									26	35
U	50	50	55	60	60	60	60	60	60	100
V				25	25	25	40	40	60	80
W				6	6	8	8	8	10	15
X				15	15	15	20	20	17	20
Y				40	40	40	50	50	93	110
Z				Ø10.5	Ø10.5	Ø10.5	Ø14	Ø14	Ø14	Ø14

All dimensions in mm; 1 inch = 25.4 mm

Tolerances according: ISO 2768-m/EN 22768-m

(n.a.: not applicable)

Please visit www.schaffner.com to find more details on filter connectors.

Accessories

Construction schematic

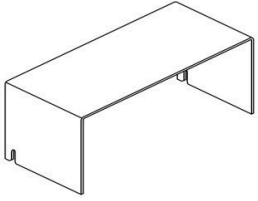

Transparent protective covers for FN3359 and FN3270 with busbars from 150 to 1000 A

Protection for the operator or inspector from accidental touching of live conductors.

Easily to be added after the filter has been installed and connected.

Installation example

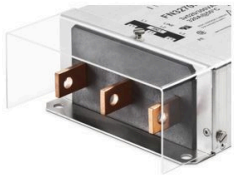

[Technical Data Sheet >](#)

Applicable Busbar Filters

FN3359

FN3270



Surge Protection Devices



SPD with a fail safe function to prevent short-circuit (separation of circuit and element is visually confirmable)

Compliance with IEC 61643-1 that meets the new JIS standards

Against indirect lightning surge for single phase / three phase power supplies Quick response for surge

Impulse current capacity 8/20 μ s-5,000A

Impulse test category: Class II (Type II)

Every pathway consists of same elements. Between line and line/between lines and ground can protect as the same level.

[Technical Data Sheet >](#)

Headquarters, Global Innovation and Development

Switzerland

Schaffner Holding AG

Industrie Nord
 Nordstrasse 11e
 4542
 Luterbach
 +41 32 681 66 26
info@schaffner.com

Sales and Application Centers

China

Schaffner EMC Ltd. Shanghai

T20-3 C, No 565 Chuangye Road, Pudong district
 201201
 Shanghai
 +86 2138139500
cschina@schaffner.com

Finland

Schaffner Oy

Sauvonrinne 19 H
 8500
 Lohja
 +358 50 468 7284
finlandsales@schaffner.com

France

Schaffner EMC S.A.S.

16-20 Rue Louis Rameau
 95875
 Bezons
 +33 1 34 34 30 60
francesales@schaffner.com

Germany

Schaffner Deutschland GmbH

Schoemperlenstrasse 12B
 76185
 Karlsruhe
 +49 721 56910
germanysales@schaffner.com

India

Schaffner India Pvt. Ltd

Regus World Trade Centre
 WTC, 22nd Floor Unit No 2238, Brigade Gateway Campus, 26/1, Dr. Rajkumar Road Malleshwaram (W)
 560055
 Bangalore
 +91 8067935355
indiasales@schaffner.com

Italy

Schaffner EMC S.r.l.

Via Ticino, 30
 20900
 Monza (MB)
 +39 039 21 41 070
italysales@schaffner.com

Japan

Schaffner EMC K.K.

ISM Sangenjaya 7F
 1-32-12 Kamiyama, Setagaya-ku
 154-0011
 Tokyo
 +81 3 5712 3650
japansales@schaffner.com

Singapore

Schaffner EMC Pte Ltd.

Blk 3015A Ubi Road 1, #05-09, Kampong Ubi Industrial Estate
 408705
 Singapore
 +65 63773283
singaporesales@schaffner.com

Spain

Schaffner EMC España

Calle Caléndula 93, Miniparc III, Edificio E El Soto de Moraleja, Alcobendas
 28109
 Madrid
 +34 917 912 900
spainsales@schaffner.com

Sweden

Schaffner EMC AB

Östermalmstrorg 1
 114 42
 Stockholm
 +46 8 5050 2425
swedensales@schaffner.com

Switzerland

Schaffner EMV AG

Industrie Nord
 Nordstrasse 11e
 4542
 Luterbach
 +41 32 681 66 26
switzerlandsales@schaffner.com

Taiwan

Schaffner EMV Ltd.

U-Town
 20 Floor-2, No 97, Section 1, XinTai 5th Road, XiZhi District
 22175
 New Taipei City
 +886 226975500
taiwansales@schaffner.com

Thailand

Schaffner EMC Co. Ltd.

Sathorn Square Tower
 Room 3780, 37FL, 98 North-Sathorn Rd, Silom, Bangrak
 10500
 Bangkok
 +66 621056397
thailandsales@schaffner.com

United Kingdom

Schaffner Ltd.

1, Oakmede Place
 Terrace Road
 RG42 4JF
 Binfield
 +44 118 9770070
uksales@schaffner.com

United States

Schaffner EMC Inc.

52 Mayfield Avenue
 Edison, New Jersey
 +1 732 225 9533
usasales@schaffner.com

To find your local partner within Schaffner's global network schaffner.com

© 2022 Schaffner Group

The content of this document has been carefully checked and understood. However, neither Schaffner nor its subsidiaries assume any liability whatsoever for any errors or inaccuracies of this document and the consequences thereof. Published specifications are subject to change without notice. Product suitability for any area of application must ultimately be determined by the customer. In all cases, products must never be operated outside their published specifications. Schaffner does not guarantee the availability of all published products. This disclaimer shall be governed by substantive Swiss law and resulting disputes shall be settled by the courts at the place of business of Schaffner Holding AG. Latest publications and a complete disclaimer can be downloaded from the Schaffner website. All trademarks recognized.