

Description

The F1490 is a high gain, two-stage RF Amplifier designed to operate within the 1.8GHz to 6.4GHz frequency range. Using a single 5V power supply, the F1490 provides two selectable gain modes (35.5dB and 39.5dB), 2.5dB of Noise Figure and 24dBm OP1dB at 2.6GHz.

The F1490 is packaged in a 3 × 3 mm, 16-pin VFQFPN package, with matched 50Ω input and output impedances for ease of integration into the signal path.

Competitive Advantage

- Combines a two-stage RF amplifier in a single, compact 3 × 3 mm QFN package
- Excellent performance over exceptionally wide bandwidths
- Two selectable gain modes
- Low current consumption

Typical Applications

- 5G Sub-6GHz massive MIMO
- Wireless infrastructure base stations
- FDD or TDD systems
- Point-to-point infrastructure
- Public safety infrastructure
- Military handhelds
- Repeaters and DAS
- General purpose RF

Features

- RF range: 1.8GHz to 6.4GHz
- 39.5dB typical gain at 2.6GHz in high gain mode
- 35.5dB typical gain at 2.6GHz in low gain mode
- 2.5dB NF at 2.6GHz
- 50Ω single-ended input and output impedances
- 5V power supply
- 75mA quiescent current consumption
- 1.8V logic compatible Standby Mode for power savings
- Operating temperature (T_{EPAD}) range: -40°C to +115°C
- 3 × 3 mm 16-VFQFPN package

Block Diagram

Figure 1. Block Diagram

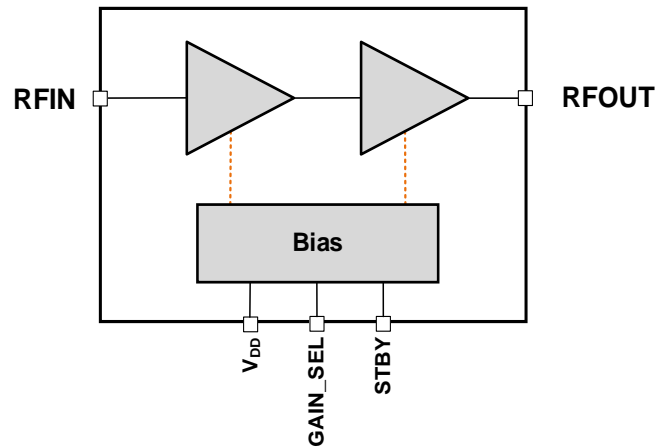

Contents

Description.....	1
Competitive Advantage	1
Typical Applications.....	1
Features	1
Block Diagram	1
Pin Assignments.....	6
Pin Descriptions.....	7
Absolute Maximum Ratings.....	8
Recommended Operating Conditions.....	9
Electrical Characteristics – General.....	9
Electrical Characteristics – 1.8GHz to 2.2GHz.....	10
Electrical Characteristics – 2.3GHz to 2.7GHz.....	11
Electrical Characteristics – 3.3GHz to 3.8GHz.....	12
Electrical Characteristics – 3.8GHz to 4.2GHz.....	13
Electrical Characteristics – 4.4GHz to 5GHz.....	14
Electrical Characteristics – 5.92GHz to 6.26GHz.....	15
Thermal Characteristics.....	15
Typical Operating Conditions	16
Typical Performance Characteristics (Band 2p0 – 1.8GHz to 2GHz).....	17
Typical Performance Characteristics (Band 2p5 – 2.3GHz to 2.7GHz).....	20
Typical Performance Characteristics (Band 3p55 – 3.3GHz to 3.8GHz).....	23
Typical Performance Characteristics (Band 3p8 – 3.8GHz to 4.2GHz).....	26
Typical Performance Characteristics (Band 4p7 – 4.4GHz to 5GHz).....	29
Typical Performance Characteristics (Band 6p0 – 5.92GHz to 6.26GHz).....	32
Functional Description	34
Standby.....	34
Gain Selection.....	34
Evaluation Kit Picture	35
Evaluation Board Schematic	36
Evaluation Kit BOM – 1.8GHz to 2.2GHz	37
Evaluation Kit BOM – 2.3GHz to 2.7GHz.....	38
Evaluation Kit BOM – 3.3GHz to 3.8GHz	39
Evaluation Kit BOM – 3.8GHz to 4.2GHz.....	40
Evaluation Kit BOM – 4.4GHz to 5GHz	41
Evaluation Board Schematic for 5.92GHz – 6.26GHz BOM.....	42
Evaluation Kit BOM – 5.92GHz to 6.26GHz	43
Power Supplies.....	44
Package Outline Drawings	45
Ordering Information.....	45
Marking Diagram	45
Revision History.....	45

List of Figures

Figure 1. Block Diagram	1
Figure 2. Pin Assignments – Top View	6
Figure 3. Gain - Low Gain Mode	17
Figure 4. Gain - High Gain Mode	17
Figure 5. Input Return Loss - Low Gain Mode	17
Figure 6. Input Return Loss - High Gain Mode	17
Figure 7. Output Return Loss - Low Gain Mode	17
Figure 8. Output Return Loss - High Gain Mode	17
Figure 9. Reverse Isolation - Low Gain Mode	18
Figure 10. Reverse Isolation - High Gain Mode	18
Figure 11. Standby Mode Gain	18
Figure 12. Current versus Power Supply Voltage	18
Figure 13. Noise Figure - Low Gain Mode	18
Figure 14. Noise Figure - High Gain Mode	18
Figure 15. Output IP3 - Low Gain Mode	19
Figure 16. Output IP3 - High Gain Mode	19
Figure 17. Output P1dB - Low Gain Mode	19
Figure 18. Output P1dB - High Gain Mode	19
Figure 19. Gain - Low Gain Mode	20
Figure 20. Gain - High Gain Mode	20
Figure 21. Input Return Loss - Low Gain Mode	20
Figure 22. Input Return Loss - High Gain Mode	20
Figure 23. Output Return Loss - Low Gain Mode	20
Figure 24. Output Return Loss - High Gain Mode	20
Figure 25. Reverse Isolation - Low Gain Mode	21
Figure 26. Reverse Isolation - High Gain Mode	21
Figure 27. Standby Mode Gain	21
Figure 28. Current versus Power Supply Voltage	21
Figure 29. Noise Figure - Low Gain Mode	21
Figure 30. Noise Figure - High Gain Mode	21
Figure 31. Output IP3 - Low Gain Mode	22
Figure 32. Output IP3 - High Gain Mode	22
Figure 33. Output P1dB - Low Gain Mode	22
Figure 34. Output P1dB - High Gain Mode	22
Figure 35. Gain - Low Gain Mode	23
Figure 36. Gain - High Gain Mode	23
Figure 37. Input Return Loss - Low Gain Mode	23
Figure 38. Input Return Loss - High Gain Mode	23
Figure 39. Output Return Loss - Low Gain Mode	23
Figure 40. Output Return Loss – High Gain Mode	23
Figure 41. Reverse Isolation - Low Gain Mode	24

Figure 42. Reverse Isolation - High Gain Mode.....	24
Figure 43. Standby Mode Gain.....	24
Figure 44. Current versus Power Supply Voltage.....	24
Figure 45. Noise Figure - Low Gain Mode.....	24
Figure 46. Noise Figure - High Gain Mode.....	24
Figure 47. Output IP3 - Low Gain Mode.....	25
Figure 48. Output IP3 - High Gain Mode.....	25
Figure 49. Output P1dB - Low Gain Mode.....	25
Figure 50. Output P1dB - High Gain Mode.....	25
Figure 51. Gain - Low Gain Mode.....	26
Figure 52. Gain - High Gain Mode.....	26
Figure 53. Input Return Loss - Low Gain Mode.....	26
Figure 54. Input Return Loss - High Gain Mode.....	26
Figure 55. Output Return Loss - Low Gain Mode.....	26
Figure 56. Output Return Loss – High Gain Mode.....	26
Figure 57. Reverse Isolation - Low Gain Mode.....	27
Figure 58. Reverse Isolation - High Gain Mode.....	27
Figure 59. Standby Mode Gain.....	27
Figure 60. Current versus Power Supply Voltage.....	27
Figure 61. Noise Figure - Low Gain Mode.....	27
Figure 62. Noise Figure - High Gain Mode.....	27
Figure 63. Output IP3 - Low Gain Mode.....	28
Figure 64. Output IP3 - High Gain Mode.....	28
Figure 65. Output P1dB - Low Gain Mode.....	28
Figure 66. Output P1dB - High Gain Mode.....	28
Figure 67. Gain - Low Gain Mode.....	29
Figure 68. Gain - High Gain Mode.....	29
Figure 69. Input Return Loss - Low Gain Mode.....	29
Figure 70. Input Return Loss - High Gain Mode.....	29
Figure 71. Output Return Loss - Low Gain Mode.....	29
Figure 72. Output Return Loss – High Gain Mode.....	29
Figure 73. Reverse Isolation - Low Gain Mode.....	30
Figure 74. Reverse Isolation - High Gain Mode.....	30
Figure 75. Standby Mode Gain.....	30
Figure 76. Current versus Power Supply Voltage.....	30
Figure 77. Noise Figure - Low Gain Mode.....	30
Figure 78. Noise Figure - High Gain Mode.....	30
Figure 79. Output IP3 - Low Gain Mode.....	31
Figure 80. Output IP3 - High Gain Mode.....	31
Figure 81. Output P1dB - Low Gain Mode.....	31
Figure 82. Output P1dB - High Gain Mode.....	31
Figure 83. Gain - High Gain Mode.....	32
Figure 84. Input Return Loss - High Gain Mode.....	32

Figure 85. Output Return Loss – High Gain Mode.....	32
Figure 86. Reverse Isolation - High Gain Mode.....	32
Figure 87. Standby Mode Gain.....	32
Figure 88. Current versus Power Supply Voltage.....	32
Figure 89. Noise Figure - High Gain Mode.....	33
Figure 90. Output IP3 - High Gain Mode.....	33
Figure 91. Output P1dB - High Gain Mode.....	33
Figure 92. Evaluation Kit: Top View.....	35
Figure 93. Evaluation Kit: Bottom View.....	35
Figure 94. Electrical Schematic.....	36
Figure 95. Electrical Schematic for 5.92GHz - 6.26GHz BOM.....	42
Figure 96. Control Pin Interface for Signal Integrity.....	44

List of Tables

Table 1. Pin Descriptions.....	7
Table 2. Absolute Maximum Ratings.....	8
Table 3. Recommended Operating Conditions.....	9
Table 4. Electrical Characteristics – General.....	9
Table 5. Electrical Characteristics – 1.8GHz to 2.2GHz (Low Gain Mode unless Otherwise Specified).....	10
Table 6. Electrical Characteristics – 2.3GHz to 2.7GHz (Low Gain Mode unless Otherwise Specified).....	11
Table 7. Electrical Characteristics – 3.3GHz to 3.8GHz (Low Gain Mode unless Otherwise Specified).....	12
Table 8. Electrical Characteristics – 3.8GHz to 4.2GHz (Low Gain Mode unless Otherwise Specified).....	13
Table 9. Electrical Characteristics – 4.4GHz to 5GHz (Low Gain Mode unless Otherwise Specified).....	14
Table 10. Electrical Characteristics – 5.92GHz to 6.26GHz (High Gain Mode unless Otherwise Specified).....	15
Table 11. Package Thermal Characteristics.....	15
Table 12. Standby Truth Table.....	34
Table 13. Gain Selection Truth Table.....	34
Table 14. 1.8GHz to 2.2GHz Evaluation Kit Bill of Materials (BOM) ^[a]	37
Table 15. 2.3GHz to 2.7GHz Evaluation Kit Bill of Materials (BOM) ^[a]	38
Table 16. 3.3GHz to 3.8GHz Evaluation Kit Bill of Materials (BOM) ^[a]	39
Table 17. 3.8GHz to 4.2GHz Evaluation Kit Bill of Materials (BOM) ^[a]	40
Table 18. 4.4GHz to 5GHz Evaluation Kit Bill of Materials (BOM) ^[a]	41
Table 19. 5.92GHz to 6.26GHz Evaluation Kit Bill of Materials (BOM) ^[a]	43

Pin Assignments

Figure 2. Pin Assignments – Top View

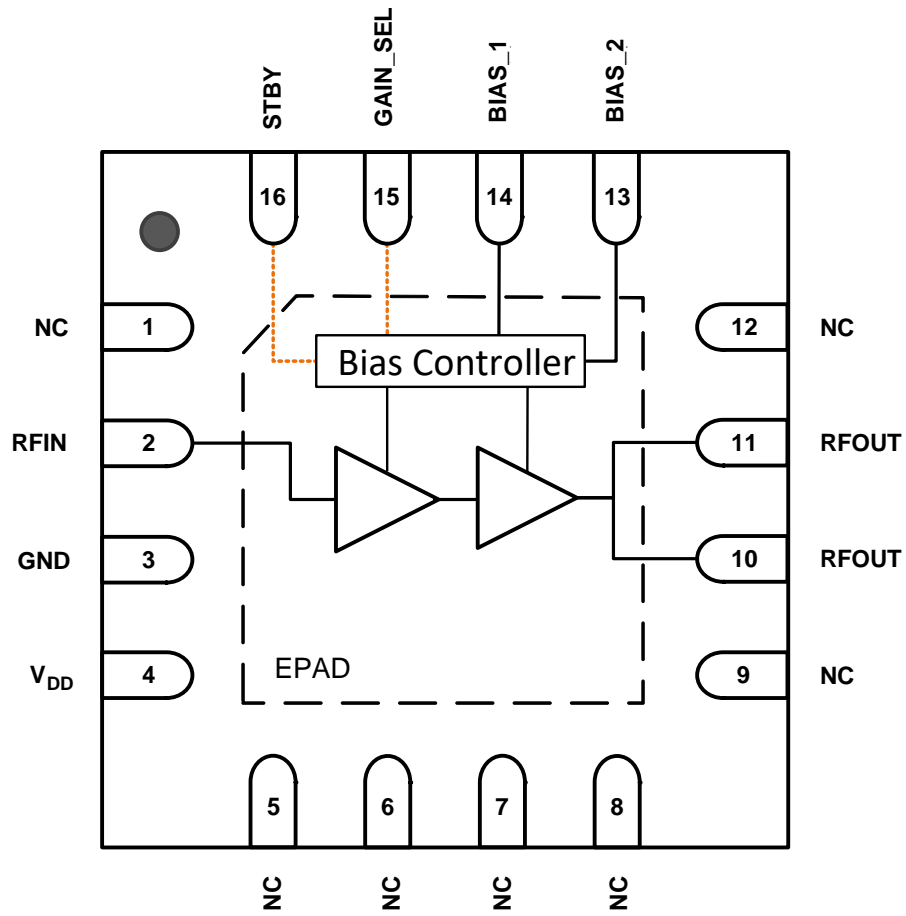

Pin Descriptions

Table 1. Pin Descriptions

Number	Name	Description
1, 5, 6, 7, 8, 9, 12	NC	No internal connection. These pins can be left unconnected, or be connected to ground (recommended). Use a via as close to the pin as possible if grounded.
2	RFIN	RF input internally matched to 50Ω. Must use an external DC block.
3	GND	Internally grounded. This pin can be left unconnected, or it can be connected to ground (recommended).
4	VDD	Pull up to V _{DD} through inductor and use bypass capacitors as close to the pin as possible. In addition to supplying the device with a DC voltage, there is also an RF signal present.
10, 11	RFOUT	RF output. Pull up to V _{DD} through inductor. Must use external DC block.
13	BIAS_2	Connect via resistor to a common V _{DD} and use bypass capacitors. Place network as close to the pin as possible.
14	BIAS_1	Connect via resistor to a common V _{DD} and use bypass. Place network as close to the pin as possible.
15	GAIN_SEL	Gain Selection pin. Logic HIGH selects High Gain Mode operation. Logic LOW (or if the pin is left unconnected or grounded) selects Low Gain Mode operation. Pin is 1.8V logic compatible.
16	STBY	Standby pin. With Logic LOW applied to this pin, the amplifier is powered off. With Logic HIGH applied to this pin (or if the pin is left unconnected), the part is in full operation mode. Pin is 1.8V logic compatible.
—	EPAD	Exposed Pad. Internally connected to ground. Solder this exposed pad to a PCB pad that uses multiple ground vias to provide heat transfer out of the device into the PCB ground planes. These multiple ground vias are also required to achieve the noted RF performance.

Absolute Maximum Ratings

Stresses above those listed below may cause permanent damage to the device. Functional operation of the device at these or any other conditions above those indicated in the operational section of this specification is not implied. Exposure to absolute maximum rating conditions for extended periods may affect device reliability.

Table 2. Absolute Maximum Ratings

Parameter	Symbol	Minimum	Maximum	Unit
V _{DD} to GND	V _{DD}	-0.3	+6.0	V
STBY	V _{CTL}	-0.3	Lower of (5.0, V _{DD} + 0.25)	V
BIAS_1 (into pin)	I _{BIAS_1}		1.5	mA
BIAS_2 (out of pin)	I _{BIAS_2}		3	mA
RFIN externally applied DC voltage	V _{RFIN}	-0.5	+0.5	V
RFOUT externally applied DC voltage	V _{RFOUT}	-0.5	+8	V
Maximum CW Input Power applied for 24 hours. V _{DD} = 5V, T _{EPAD} = 115°C, input / output VSWR < 2:1 based on a 50Ω system. Standby = logic HIGH: ON state. [a]	P _{MAX_IN_ON}		22	dBm
Maximum CW Input Power applied for 24 hour. V _{DD} = 5V, T _{EPAD} = 115°C, input / output VSWR < 2:1 based on a 50Ω system. Standby = logic LOW: OFF state. [a]	P _{MAX_IN_OFF}		22	
Junction Temperature	T _{JMAX}		150	°C
Storage Temperature Range	T _{st}	-65	150	°C
Lead Temperature (soldering, 10s)			260	°C
ElectroStatic Discharge – HBM (JEDEC/ESDA JS-001-2012)	V _{ESDHBM}		1000	V
ElectroStatic Discharge – CDM (JEDEC 22-C101F)	V _{ESDCDM}		500	V

[a] Exposure to these maximum RF levels can result in significantly higher I_{DD} current draw due to overdriving the amplifier stages.

Recommended Operating Conditions

Table 3. Recommended Operating Conditions

Parameter	Symbol	Condition	Minimum	Typical	Maximum	Unit
Power Supply Voltage	V _{DD}		4.75	5	5.25	V
Operating Temperature Range	T _{EPAD}	Exposed Paddle	-40		+115	°C
RF Frequency Range ^[a]	f _{RF}	2GHz Tuning Set	1.8		2.2	GHz
		2.5GHz Tuning Set	2.3		2.7	
		3.55GHz Tuning Set	3.3		3.8	
		4.0GHz Tuning Set	3.8		4.2	
		4.7GHz Tuning Set	4.4		5.0	
		6.0GHz Tuning Set	5.92		6.26	
RFIN Port Impedance	Z _{RFI}	Single Ended		50		Ω
RFOUT Port Impedance	Z _{RFO}	Single Ended		50		Ω

[a] Using external matching, gain flatness is optimized from 1.8GHz to 2.2GHz (2GHz Tuning Set), 2.3GHz to 2.7GHz (2.5GHz Tuning Set), 3.3GHz to 3.8GHz (3.55GHz Tuning Set), 3.8GHz to 4.2GHz (4.0GHz Tuning Set), 4.4GHz to 5.0GHz (4.7GHz Tuning Set), and 5.92GHz to 6.26GHz (6.0GHz Tuning Set).

Electrical Characteristics – General

Specifications apply when operated as a TX amplifier with tuning optimized for desired band of interest, V_{DD} = +5.0V, T_{EPAD} = +25°C, STBY = HIGH, Z_S = Z_L = 50Ω, Evaluation Kit trace and connector losses are de-embedded, unless otherwise stated.

Table 4. Electrical Characteristics – General

Parameter	Symbol	Condition	Minimum	Typical	Maximum	Unit
Logic Input High	V _{IH}		1.17 ^[a]		V _{DD}	V
Logic Input Low	V _{IL}		-0.3		0.63	V
Logic Current	I _{IH} , I _{IL}	STBY pin. V _{CTL} = 1.8 V		40		μA
Quiescent Current ^[b]	I _{DD_OH}	High Gain Mode		75	98	mA
	I _{DD_OL}	Low Gain Mode		75	98	
Standby Current	I _{DD_STBY}	STBY = LOW		2.5		mA
Standby Switching Time	t _{ON}	50% STBY control to within 0.5dB of the on-state final gain value		250		ns
	t _{OFF}	50% STBY control to I _{DD} < 10mA		250		

[a] Specifications in the minimum/maximum columns that are shown in **bold italics** are confirmed by test. Specifications in these columns that are not shown in bold italics are confirmed by design characterization.

[b] I_{DD} refers to the nominal small signal bias current.

Electrical Characteristics – 1.8GHz to 2.2GHz

Specifications apply when operated as a TX amplifier with tuning optimized for the 1.8GHz to 2.2GHz band, $V_{DD} = +5.0V$, $f_{RF} = 2.0GHz$, $T_{EPAD} = +25^{\circ}C$, $GAIN_SEL = LOW$, $STBY = HIGH$, $Z_S = Z_L = 50\Omega$, Evaluation Kit trace and connector losses are de-embedded, unless otherwise stated.

Table 5. Electrical Characteristics – 1.8GHz to 2.2GHz (Low Gain Mode unless Otherwise Specified)

Parameter	Symbol	Condition	Minimum	Typical	Maximum	Unit
Gain	G	Low Gain Mode		35		dB
		High Gain Mode		39		
Gain Flatness	G_{FLAT}	$f_{RF} = 1.8GHz$ to $2.2GHz$		1.3		dB
Gain Variation Over Temperature	G_{TEMP}	$T_{EPAD} = -40^{\circ}C$ to $+115^{\circ}C$, referenced to $T_{EPAD} = 25^{\circ}C$		+0.8 / -0.3		dB
STBY Mode Gain	G_{STBY}	STBY = logic LOW $P_{IN} \leq -15dBm$ $f_{RF} = 1.8GHz$ to $2.2GHz$		-40		dB
RF Input Return Loss	RL_{RFIN}	$f_{RF} = 1.8GHz$ to $2.2GHz$		21		dB
RF Output Return Loss	RL_{RFOUT}	$f_{RF} = 1.8GHz$ to $2.2GHz$		8		dB
Reverse Isolation	ISO_{REV}			55		dB
Noise Figure	NF			2.5		dB
Output Third Order Intercept Point	OIP3	$P_{OUT} = +4dBm$ / tone 1MHz tone separation		37		dBm
Output 1dB Compression Point	OP1dB			24		dBm

Electrical Characteristics – 2.3GHz to 2.7GHz

Specifications apply when operated as a TX amplifier with tuning optimized for the 2.3GHz to 2.7GHz band, $V_{DD} = +5.0V$, $f_{RF} = 2.6GHz$, $T_{EPAD} = +25^{\circ}C$, $GAIN_SEL = LOW$, $STBY = HIGH$, $Z_S = Z_L = 50\Omega$, Evaluation Kit trace and connector losses are de-embedded, unless otherwise stated.

Table 6. Electrical Characteristics – 2.3GHz to 2.7GHz (Low Gain Mode unless Otherwise Specified)

Parameter	Symbol	Condition	Minimum	Typical	Maximum	Unit
Gain	G	Low Gain Mode	33^[a]	35.5		dB
		High Gain Mode		39.5		
Gain Flatness	G _{FLAT}	$f_{RF} = 2.3GHz$ to $2.7GHz$		0.7		dB
Gain Variation Over Temperature	G _{TEMP}	$T_{EPAD} = -40^{\circ}C$ to $+115^{\circ}C$, referenced to $T_{EPAD} = 25^{\circ}C$		+1.5 / -1.0		dB
STBY Mode Gain	G _{STBY}	STBY = logic LOW $P_{IN} \leq -15dBm$ $f_{RF} = 2.3GHz$ to $2.7GHz$		-39		dB
RF Input Return Loss	RL _{RFIN}	$f_{RF} = 2.3GHz$ to $2.7GHz$		18		dB
RF Output Return Loss	RL _{RFOUT}	$f_{RF} = 2.3GHz$ to $2.7GHz$		12		dB
Reverse Isolation	ISO _{REV}			55		dB
Noise Figure	NF			2.5		dB
Output Third Order Intercept Point	OIP3	$P_{OUT} = +4dBm$ / tone 1MHz tone separation		38		dBm
		$P_{OUT} = +4dBm$ / tone 1MHz tone separation $V_{DD} = 4.75V$ to $5.25V$ $T_{EPAD} = -40^{\circ}C$ to $+115^{\circ}C$	30			
Output 1dB Compression Point	OP1dB			24		dBm
		$V_{DD} = 4.75V$ to $5.25V$ $T_{EPAD} = -40^{\circ}C$ to $+115^{\circ}C$	21			

[a] Specifications in the minimum/maximum columns that are shown in **bold italics** are confirmed by test. Specifications in these columns that are not shown in bold italics are confirmed by design characterization.

Electrical Characteristics – 3.3GHz to 3.8GHz

Specifications apply when operated as a TX amplifier with tuning optimized for the 3.3GHz to 3.8GHz band, $V_{DD} = +5.0V$, $f_{RF} = 3.55GHz$, $T_{EPAD} = +25^{\circ}C$, $GAIN_SEL = LOW$, $STBY = HIGH$, $Z_S = Z_L = 50\Omega$, Evaluation Kit trace and connector losses are de-embedded, unless otherwise stated.

Table 7. Electrical Characteristics – 3.3GHz to 3.8GHz (Low Gain Mode unless Otherwise Specified)

Parameter	Symbol	Condition	Minimum	Typical	Maximum	Unit
Gain	G	Low Gain Mode		36		dB
		High Gain Mode		40		
Gain Flatness	G_{FLAT}	$f_{RF} = 3.3GHz$ to $3.8GHz$		0.7		dB
Gain Variation Over Temperature	G_{TEMP}	$T_{EPAD} = -40^{\circ}C$ to $+115^{\circ}C$, referenced to $T_{EPAD} = 25^{\circ}C$		+1.9 / -1.7		dB
STBY Mode Gain	G_{STBY}	STBY = logic LOW $P_{IN} \leq -15dBm$ $f_{RF} = 3.3GHz$ to $3.8GHz$		-43		dB
RF Input Return Loss	RL_{RFIN}	$f_{RF} = 3.3GHz$ to $3.8GHz$		11		dB
RF Output Return Loss	RL_{RFOUT}	$f_{RF} = 3.3GHz$ to $3.8GHz$		10		dB
Reverse Isolation	ISO_{REV}			55		dB
Noise Figure	NF			2.8		dB
Output Third Order Intercept Point	OIP3	$P_{OUT} = +4dBm$ / tone 1MHz tone separation		34		dBm
Output 1dB Compression Point	OP1dB			23		dBm

Electrical Characteristics – 3.8GHz to 4.2GHz

Specifications apply when operated as a TX amplifier with tuning optimized for the 3.8GHz to 4.2GHz band, $V_{DD} = +5.0V$, $f_{RF} = 4GHz$, $T_{EPAD} = +25^{\circ}C$, $GAIN_SEL = LOW$, $STBY = HIGH$, $Z_S = Z_L = 50\Omega$, Evaluation Kit trace and connector losses are de-embedded, unless otherwise stated.

Table 8. Electrical Characteristics – 3.8GHz to 4.2GHz (Low Gain Mode unless Otherwise Specified)

Parameter	Symbol	Condition	Minimum	Typical	Maximum	Unit
Gain	G	Low Gain Mode		35		dB
		High Gain Mode		40		
Gain Flatness	G_{FLAT}	$f_{RF} = 3.8GHz$ to $4.2GHz$		2.4		dB
Gain Variation Over Temperature	G_{TEMP}	$T_{EPAD} = -40^{\circ}C$ to $+115^{\circ}C$, referenced to $T_{EPAD} = 25^{\circ}C$		+2.6 / -2.2		dB
STBY Mode Gain	G_{STBY}	STBY = logic LOW $P_{IN} \leq -15dBm$ $f_{RF} = 3.8GHz$ to $4.2GHz$		-45		dB
RF Input Return Loss	RL_{RFIN}	$f_{RF} = 3.8GHz$ to $4.2GHz$		8		dB
RF Output Return Loss	RL_{RFOUT}	$f_{RF} = 3.8GHz$ to $4.2GHz$		7		dB
Reverse Isolation	ISO_{REV}			51		dB
Noise Figure	NF			3.5		dB
Output Third Order Intercept Point	OIP3	$P_{OUT} = +4dBm$ / tone 1MHz tone separation		35		dBm
Output 1dB Compression Point	OP1dB			24		dBm

Electrical Characteristics – 4.4GHz to 5GHz

Specifications apply when operated as a TX amplifier with tuning optimized for the 4.4GHz to 5GHz band, $V_{DD} = +5.0V$, $f_{RF} = 4.7GHz$, $T_{EPAD} = +25^{\circ}C$, $GAIN_SEL = LOW$, $STBY = HIGH$, $Z_S = Z_L = 50\Omega$, Evaluation Kit trace and connector losses are de-embedded, unless otherwise stated.

Table 9. Electrical Characteristics – 4.4GHz to 5GHz (Low Gain Mode unless Otherwise Specified)

Parameter	Symbol	Condition	Minimum	Typical	Maximum	Unit
Gain	G	Low Gain Mode		34		dB
		High Gain Mode		40		
Gain Flatness	G _{FLAT}	$f_{RF} = 4.4GHz$ to $5GHz$		2.5		dB
Gain Variation Over Temperature	G _{TEMP}	$T_{EPAD} = -40^{\circ}C$ to $+115^{\circ}C$, referenced to $T_{EPAD} = 25^{\circ}C$		+2.6 / -2.3		dB
STBY Mode Gain	G _{STBY}	STBY = logic LOW $P_{IN} \leq -15dBm$ $f_{RF} = 4.4GHz$ to $5GHz$		-40		dB
RF Input Return Loss	RL _{RFIN}	$f_{RF} = 4.4GHz$ to $5GHz$		7		dB
RF Output Return Loss	RL _{RFOUT}	$f_{RF} = 4.4GHz$ to $5GHz$		5		dB
Reverse Isolation	ISO _{REV}			49		dB
Noise Figure	NF			3.4		dB
Output Third Order Intercept Point	OIP3	$P_{OUT} = +4dBm$ / tone 1MHz tone separation		34		dBm
Output 1dB Compression Point	OP1dB			24		dBm

Electrical Characteristics – 5.92GHz to 6.26GHz

Specifications apply when operated as a TX amplifier with tuning optimized for the 5.92GHz to 6.26GHz band, $V_{DD} = +5.0V$, $f_{RF} = 6.0GHz$, $T_{EPAD} = +25^{\circ}C$, $GAIN_SEL = HIGH$, $STBY = HIGH$, $Z_S = Z_L = 50\Omega$, Evaluation Kit trace and connector losses are de-embedded, unless otherwise stated. Specifications shown for 5.92GHz to 6.26GHz require accommodating additional shunt component at RFIN (pin 2 port). See Figure 95. Electrical Schematic for 5.92GHz - 6.26GHz BOM.

Table 10. Electrical Characteristics – 5.92GHz to 6.26GHz (High Gain Mode unless Otherwise Specified)

Parameter	Symbol	Condition	Minimum	Typical	Maximum	Unit
Gain	G	High Gain Mode		33		dB
Gain Flatness	G _{FLAT}	$f_{RF} = 5.92GHz$ to $6.26GHz$		2.8		dB
		$f_{RF} = 5.92GHz$ to $6.26GHz$ Each 100MHz subrange within the specified frequency range		1.4		
Gain Variation Over Temperature	G _{TEMP}	$T_{EPAD} = -40^{\circ}C$ to $+115^{\circ}C$, referenced to $T_{EPAD} = 25^{\circ}C$		+2.2 / -2.1		dB
STBY Mode Gain	G _{STBY}	STBY = logic LOW $P_{IN} \leq -15dBm$ $f_{RF} = 5.92GHz$ to $6.26GHz$		-34		dB
RF Input Return Loss	RL _{RFIN}	$f_{RF} = 5.92GHz$ to $6.26GHz$		10		dB
RF Output Return Loss	RL _{RFOUT}	$f_{RF} = 5.92GHz$ to $6.26GHz$		12		dB
Reverse Isolation	ISO _{REV}			44		dB
Noise Figure	NF			4.6		dB
Output Third Order Intercept Point	OIP3	$P_{OUT} = +4dBm$ / tone 1MHz tone separation		33.5		dBm
Output 1dB Compression Point	OP1dB			22.5		dBm

Thermal Characteristics

Table 11. Package Thermal Characteristics

Parameter	Symbol	Value	Unit
Junction to Ambient Thermal Resistance	θ_{JA}	55.2	$^{\circ}C/W$
Junction to Case Thermal Resistance. (Case is defined as the exposed paddle)	θ_{JC_BOT}	8.175	$^{\circ}C/W$
Moisture Sensitivity Rating (Per J-STD-020)		MSL 1	

Typical Operating Conditions

Unless otherwise stated the typical operating graphs were measured under the following conditions:

- $V_{DD} = 5.0V$
- STBY = HIGH
- GAIN_SEL = LOW
- $T_{EPAD} = +25^{\circ}C$
- $f_{RF} = 2.0GHz$
- $f_{RF} = 2.6GHz$
- $f_{RF} = 3.55GHz$
- $f_{RF} = 4.0GHz$
- $f_{RF} = 4.7GHz$
- $f_{RF} = 6.0GHz$
- $Z_S = Z_L = 50\Omega$ Single Ended
- Pout = 4dBm/tone and 1MHz Tone Spacing for OIP3

Typical Performance Characteristics (Band 2p0 - 1.8GHz to 2GHz)

Figure 3. Gain - Low Gain Mode

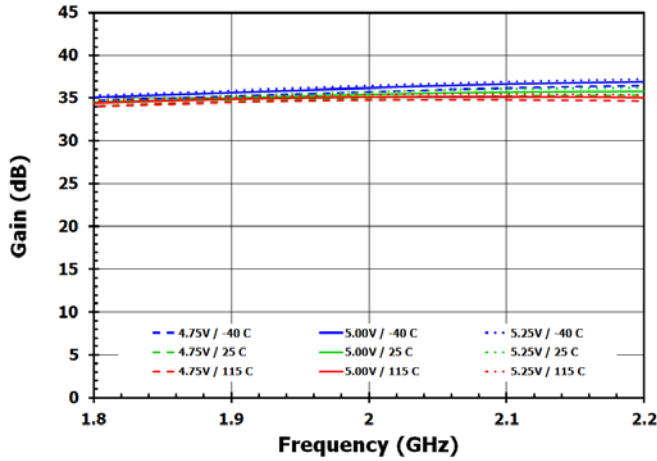

Figure 4. Gain - High Gain Mode

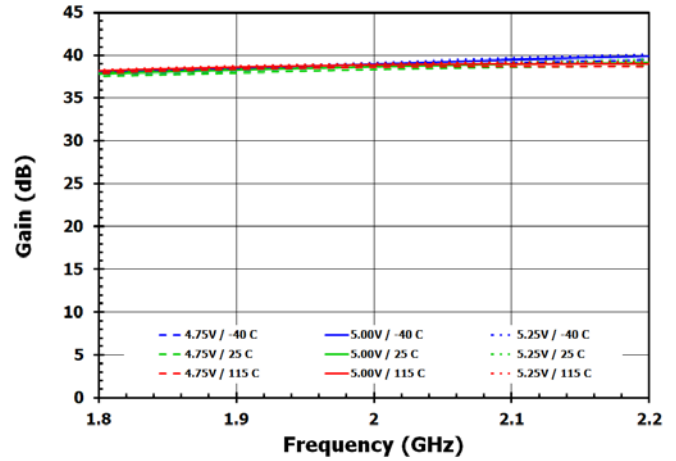

Figure 5. Input Return Loss - Low Gain Mode

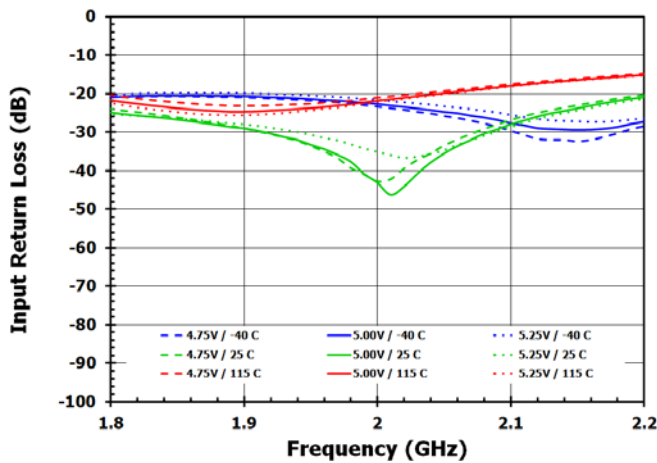

Figure 6. Input Return Loss - High Gain Mode

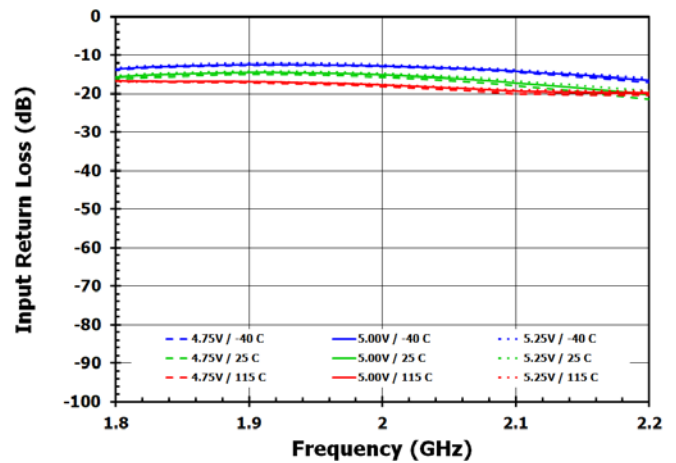

Figure 7. Output Return Loss - Low Gain Mode

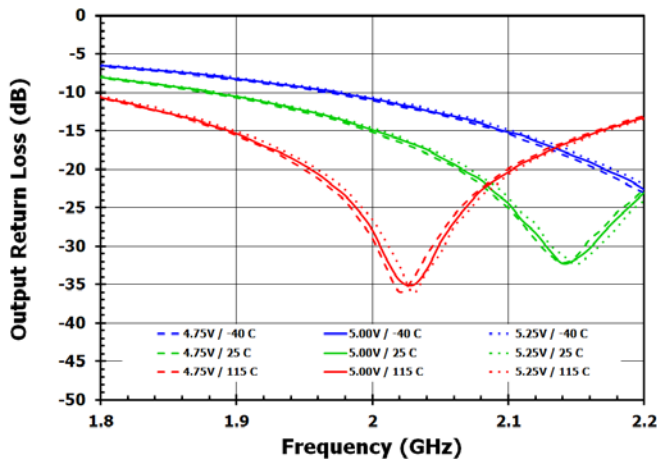

Figure 8. Output Return Loss - High Gain Mode

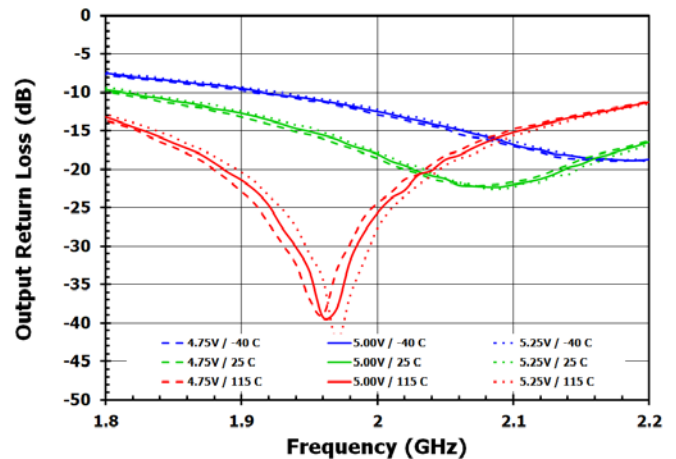

Figure 9. Reverse Isolation - Low Gain Mode

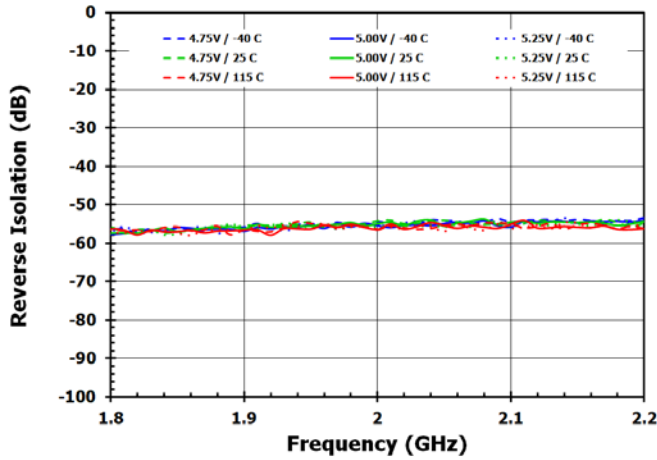

Figure 10. Reverse Isolation - High Gain Mode

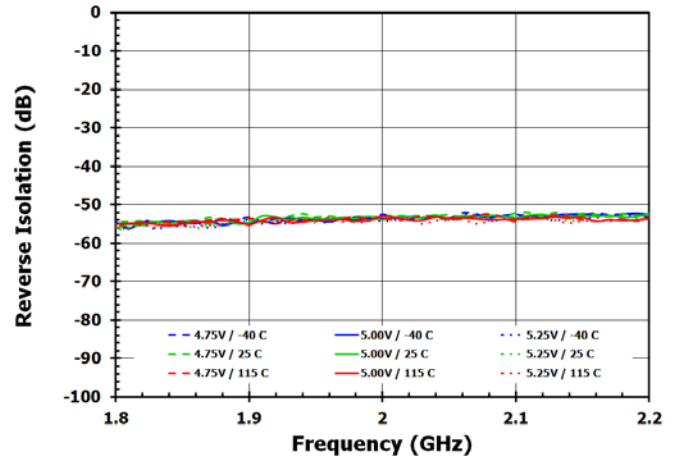

Figure 11. Standby Mode Gain

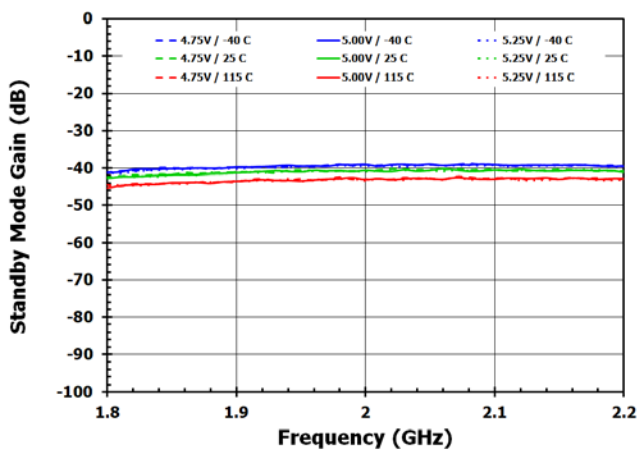

Figure 12. Current versus Power Supply Voltage

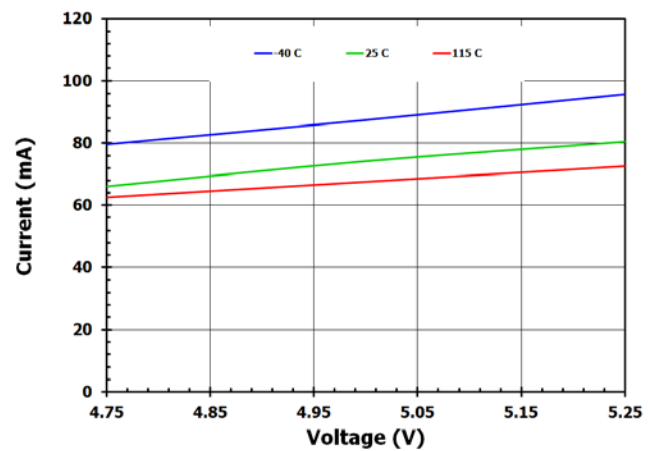

Figure 13. Noise Figure - Low Gain Mode

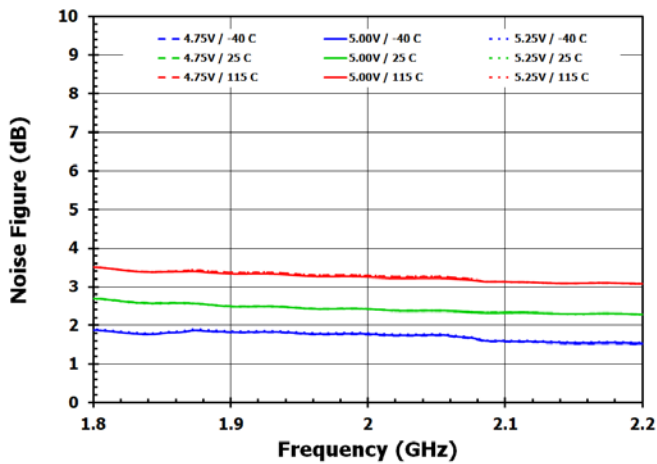

Figure 14. Noise Figure - High Gain Mode

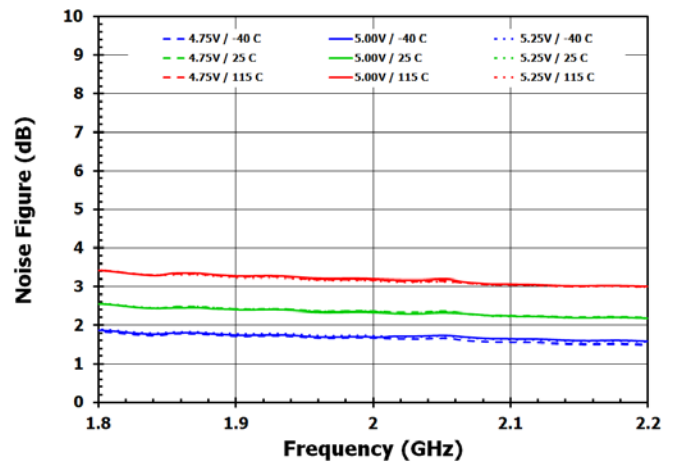

Figure 15. Output IP3 - Low Gain Mode

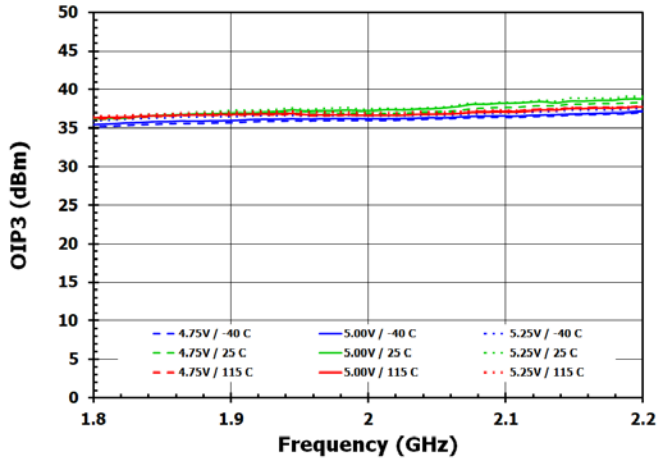

Figure 16. Output IP3 - High Gain Mode

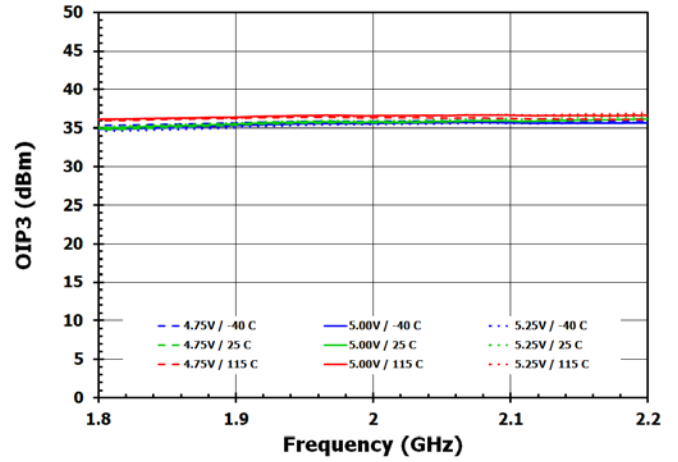

Figure 17. Output P1dB - Low Gain Mode

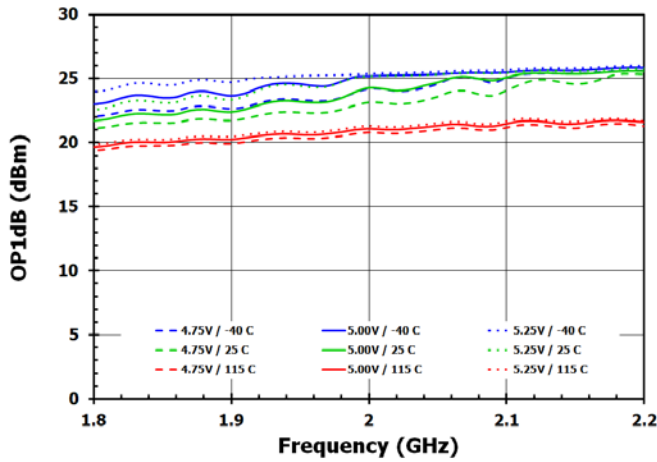
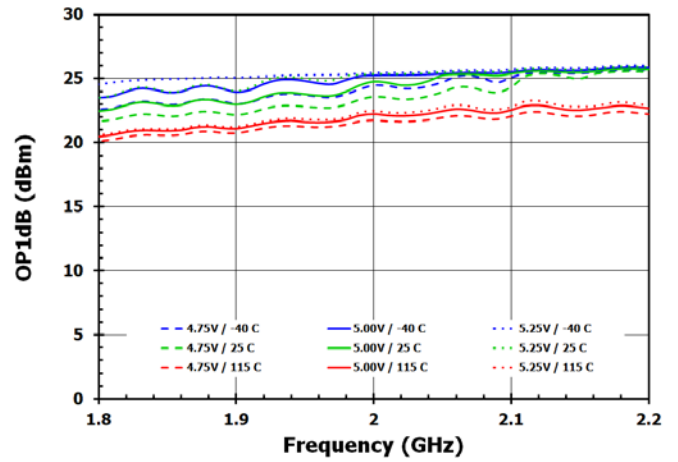

Figure 18. Output P1dB - High Gain Mode



Typical Performance Characteristics (Band 2p5 – 2.3GHz to 2.7GHz)

Figure 19. Gain - Low Gain Mode

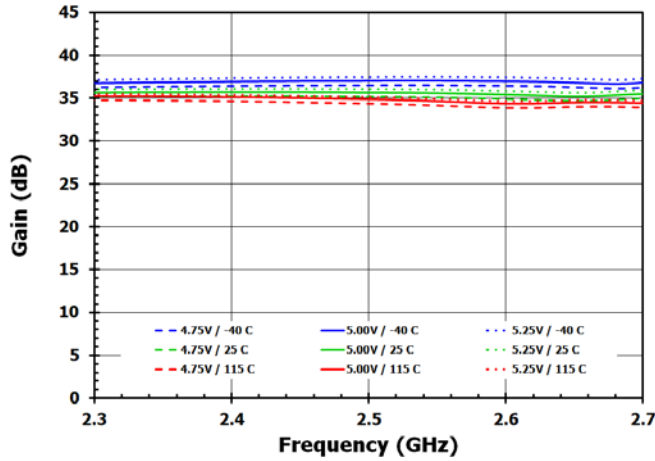

Figure 20. Gain - High Gain Mode

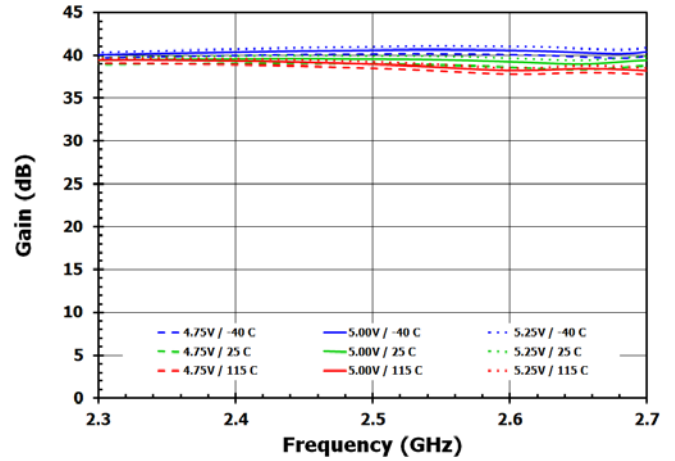

Figure 21. Input Return Loss - Low Gain Mode

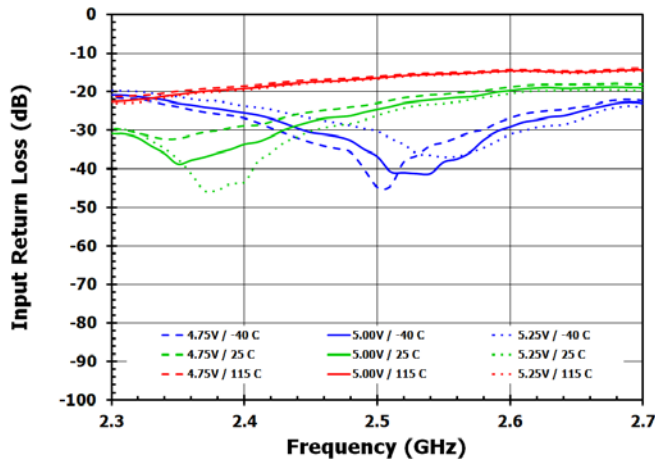

Figure 22. Input Return Loss - High Gain Mode

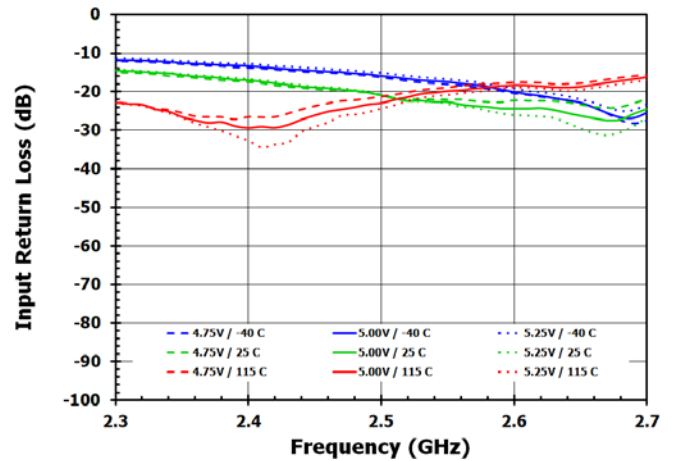

Figure 23. Output Return Loss - Low Gain Mode

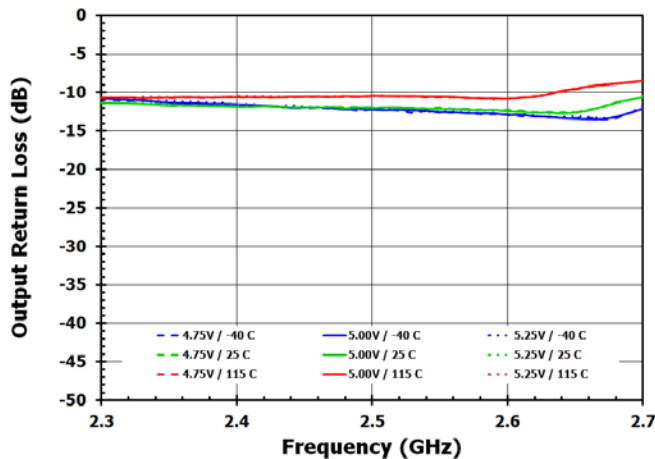

Figure 24. Output Return Loss - High Gain Mode

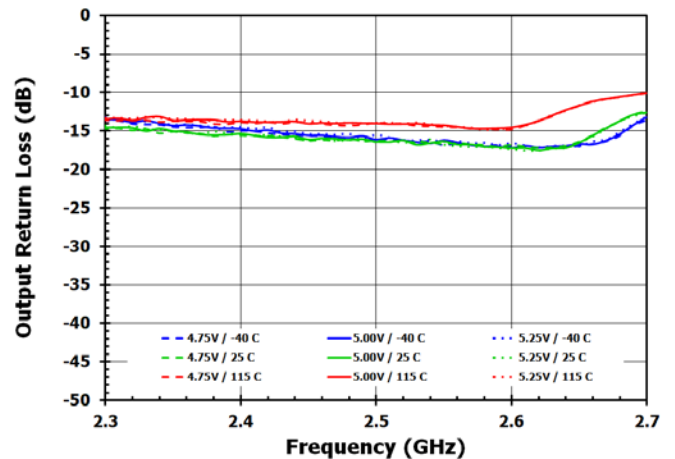

Figure 25. Reverse Isolation - Low Gain Mode

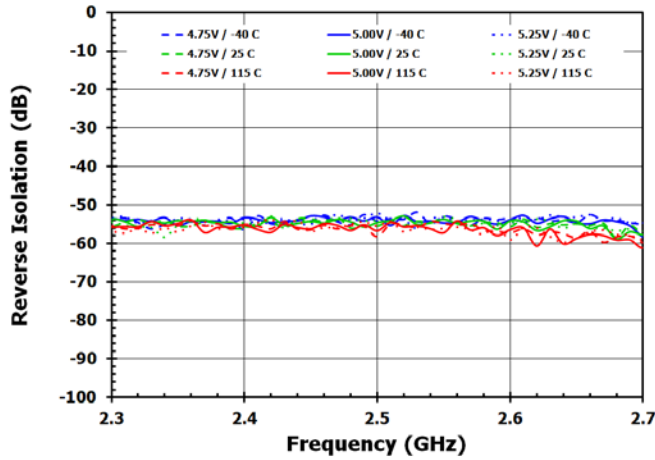

Figure 26. Reverse Isolation - High Gain Mode

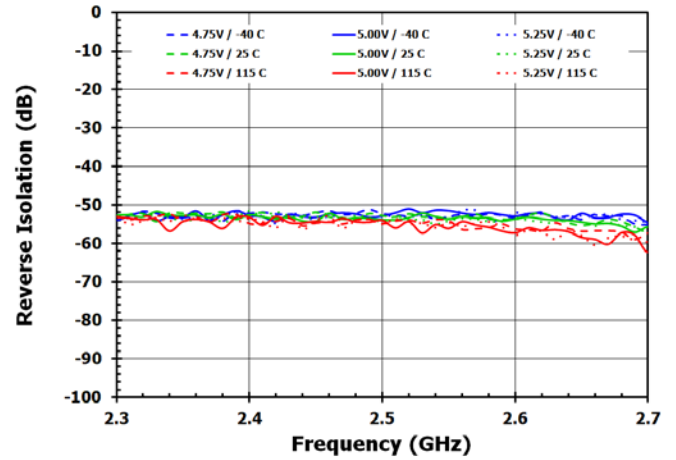

Figure 27. Standby Mode Gain

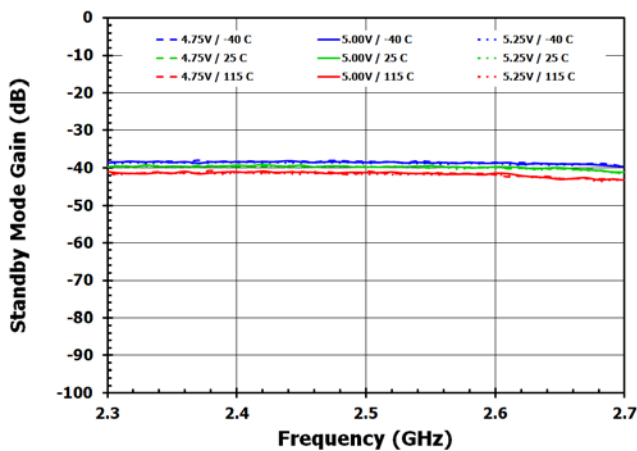

Figure 28. Current versus Power Supply Voltage

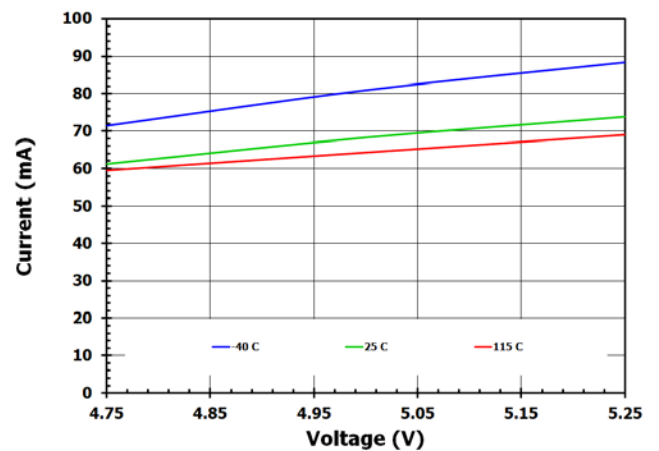

Figure 29. Noise Figure - Low Gain Mode

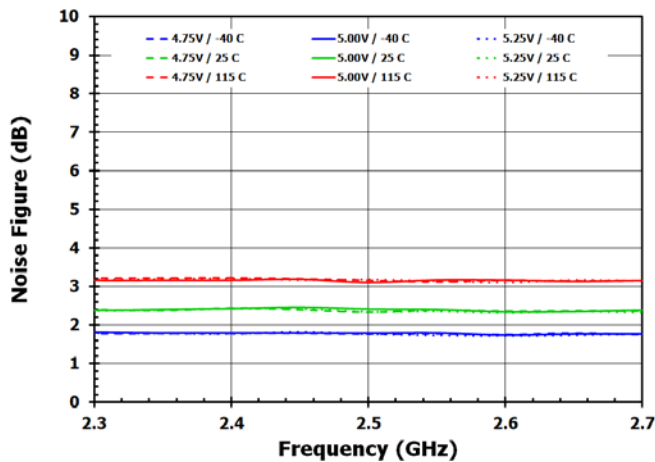

Figure 30. Noise Figure - High Gain Mode

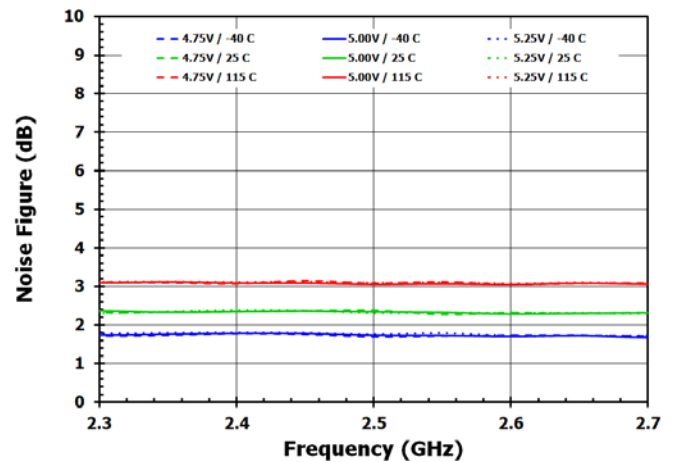

Figure 31. Output IP3 - Low Gain Mode

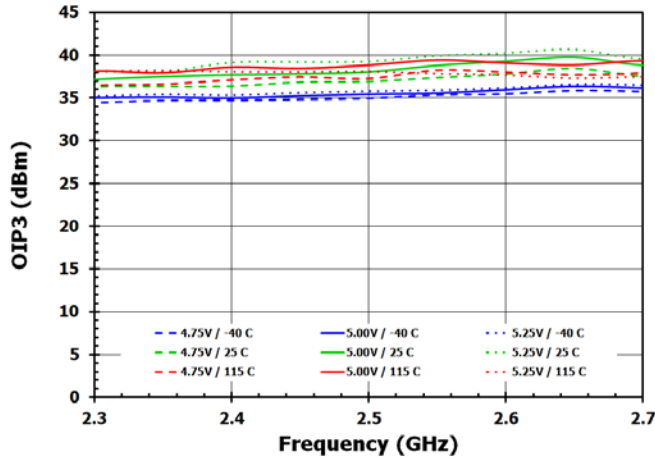

Figure 32. Output IP3 - High Gain Mode

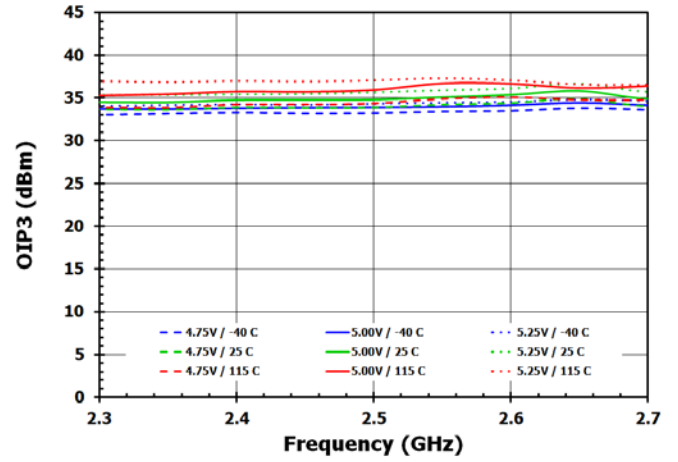

Figure 33. Output P1dB - Low Gain Mode

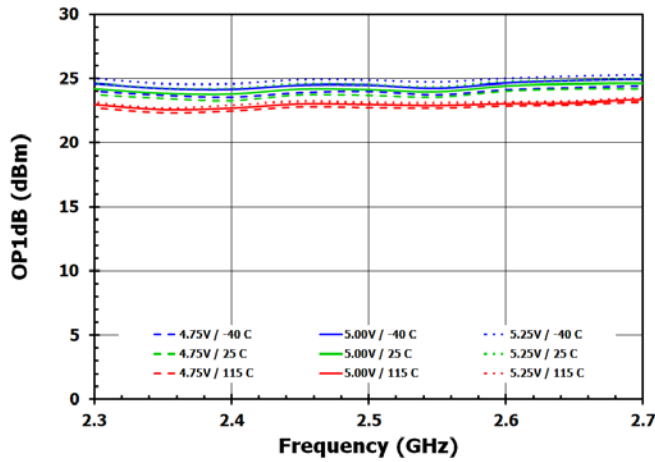
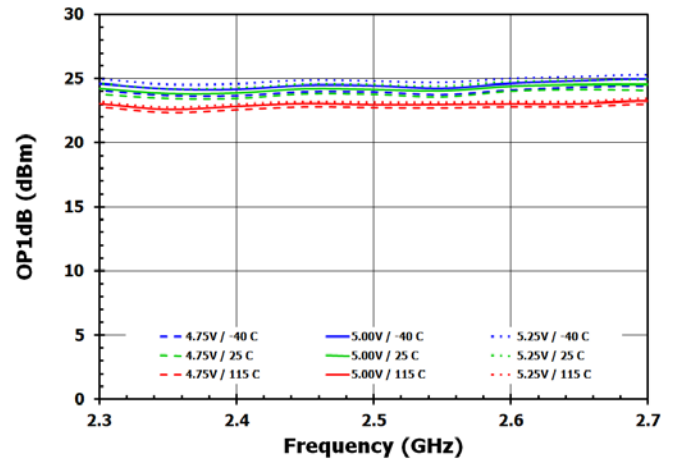

Figure 34. Output P1dB - High Gain Mode



Typical Performance Characteristics (Band 3p55 – 3.3GHz to 3.8GHz)

Figure 35. Gain - Low Gain Mode

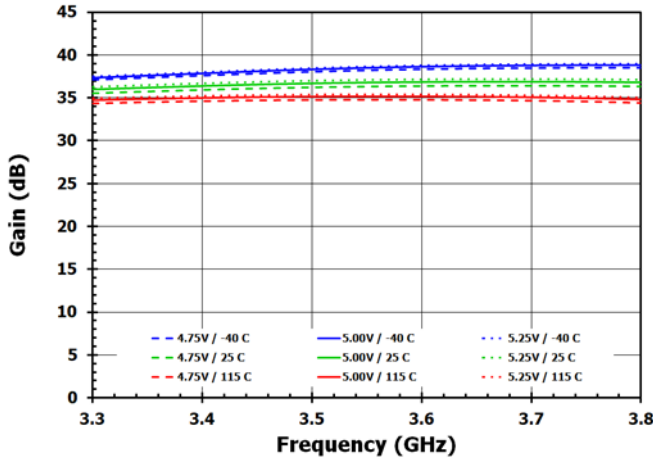

Figure 36. Gain - High Gain Mode

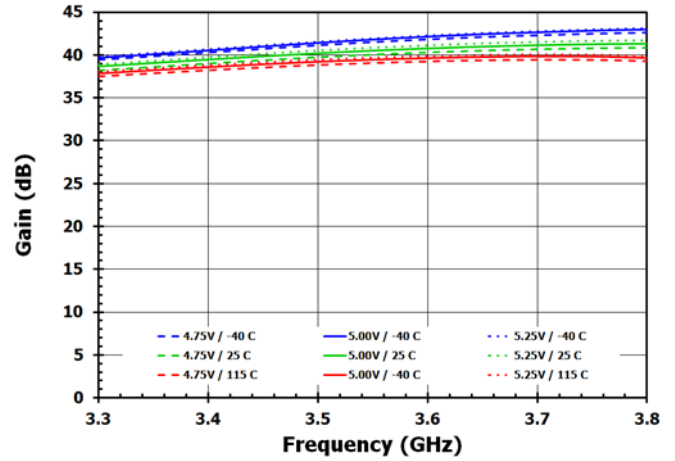

Figure 37. Input Return Loss - Low Gain Mode

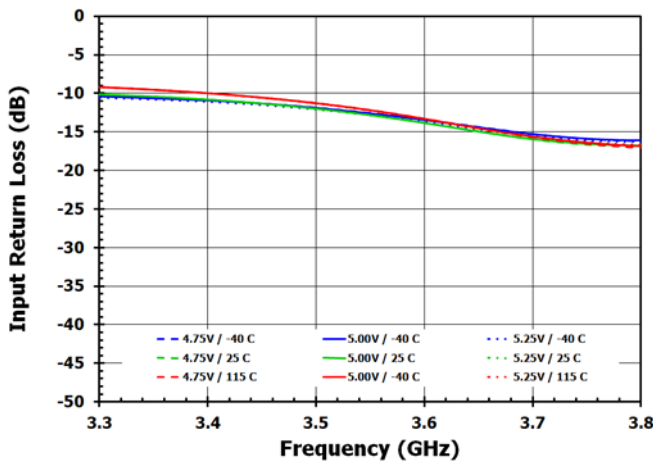

Figure 38. Input Return Loss - High Gain Mode

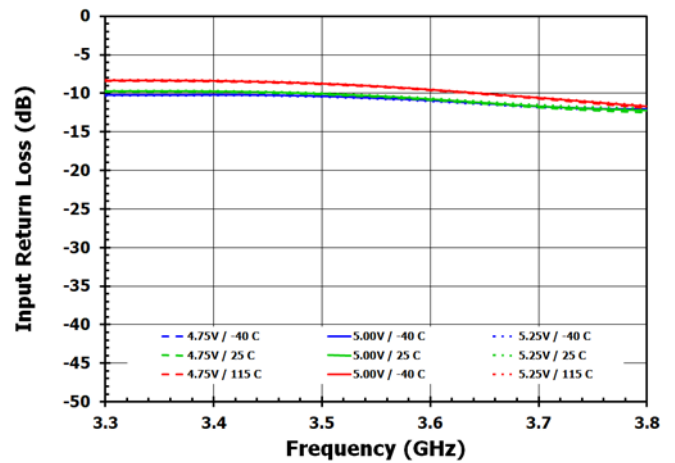

Figure 39. Output Return Loss - Low Gain Mode

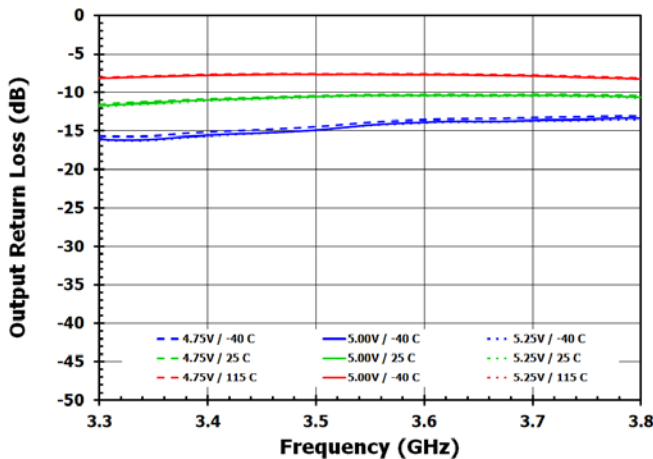

Figure 40. Output Return Loss - High Gain Mode

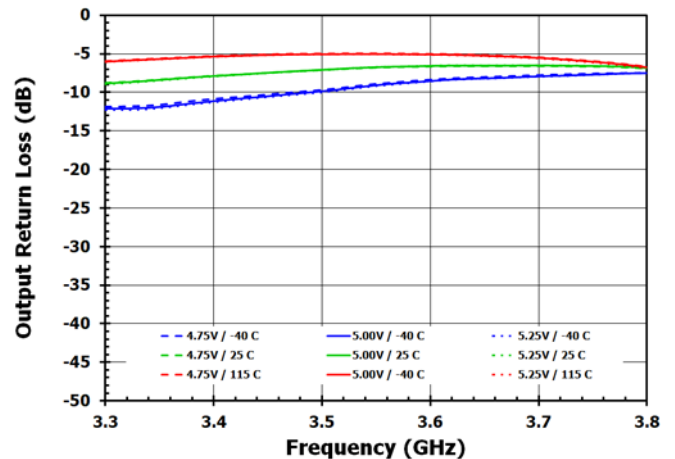

Figure 41. Reverse Isolation - Low Gain Mode

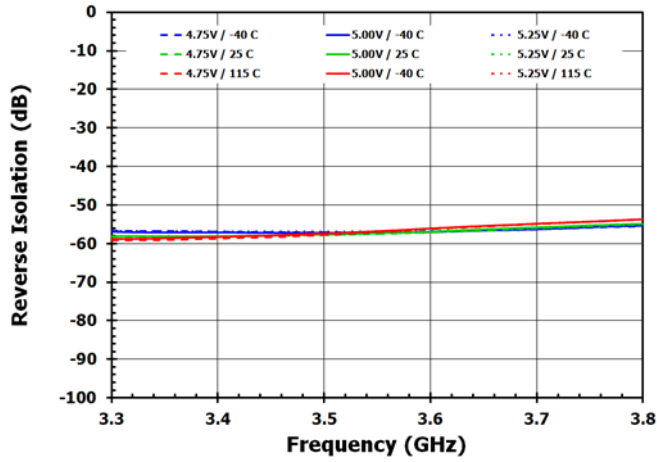

Figure 42. Reverse Isolation - High Gain Mode

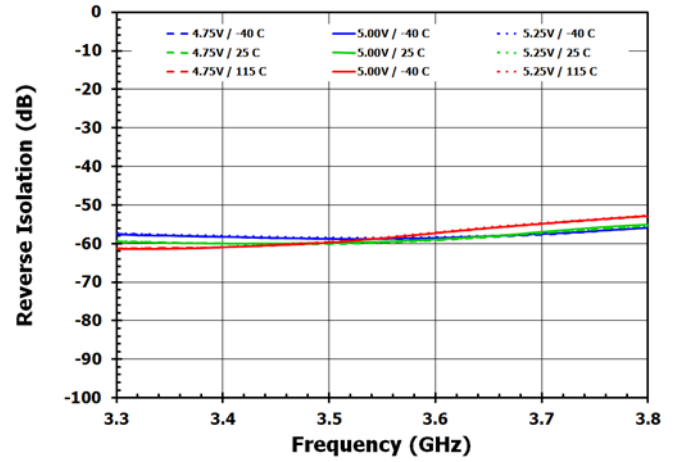

Figure 43. Standby Mode Gain

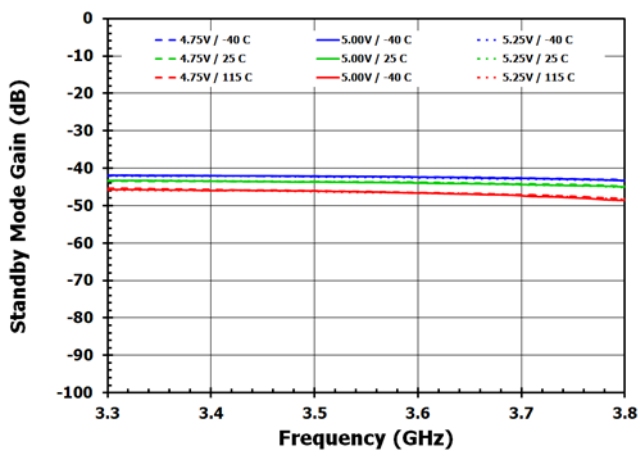

Figure 44. Current versus Power Supply Voltage

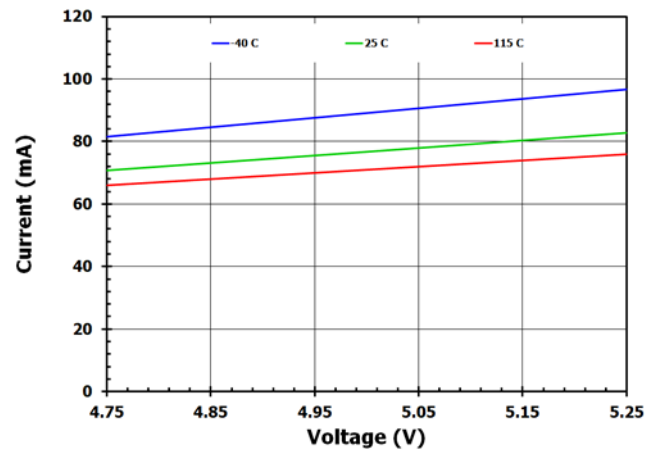

Figure 45. Noise Figure - Low Gain Mode

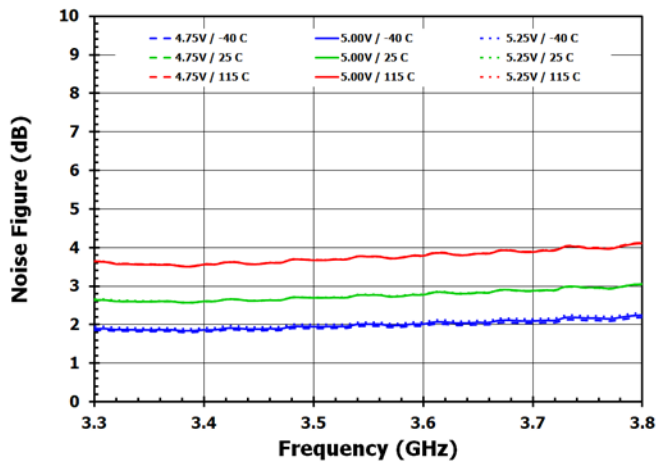

Figure 46. Noise Figure - High Gain Mode

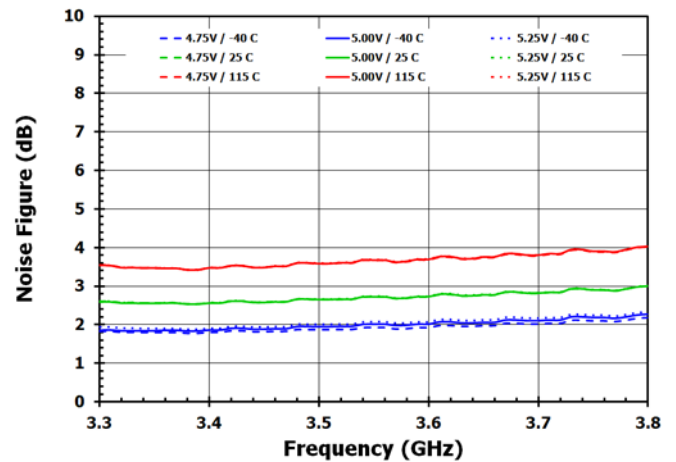

Figure 47. Output IP3 - Low Gain Mode

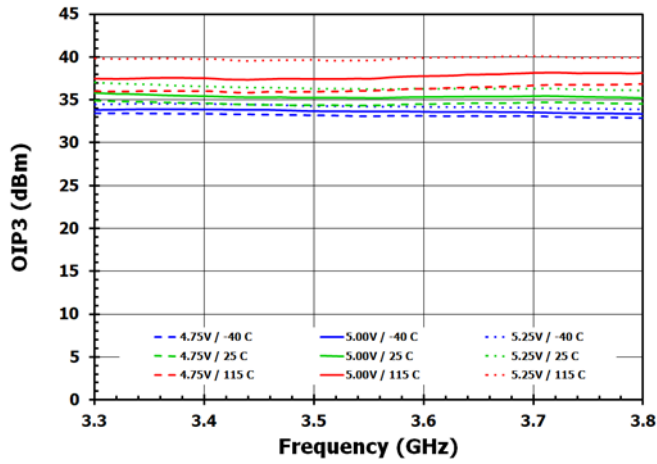

Figure 48. Output IP3 - High Gain Mode

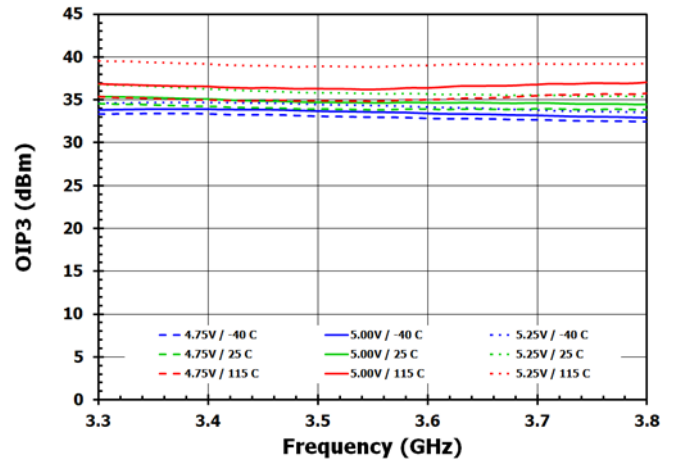

Figure 49. Output P1dB - Low Gain Mode

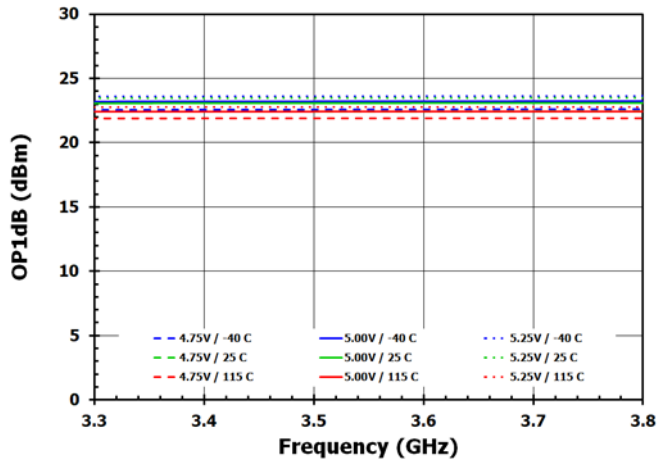
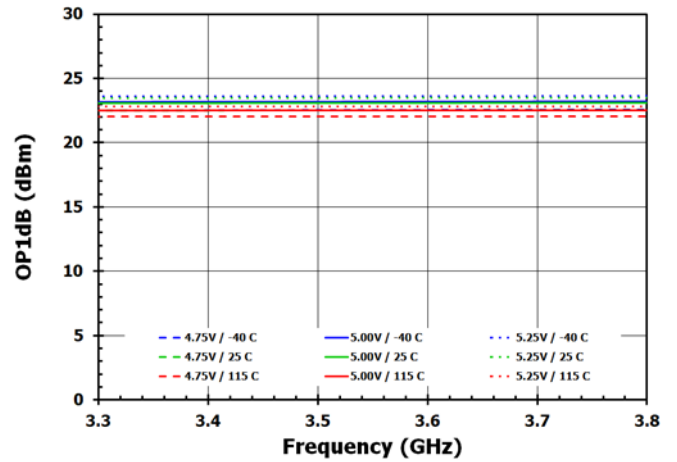

Figure 50. Output P1dB - High Gain Mode



Typical Performance Characteristics (Band 3p8 – 3.8GHz to 4.2GHz)

Figure 51. Gain - Low Gain Mode

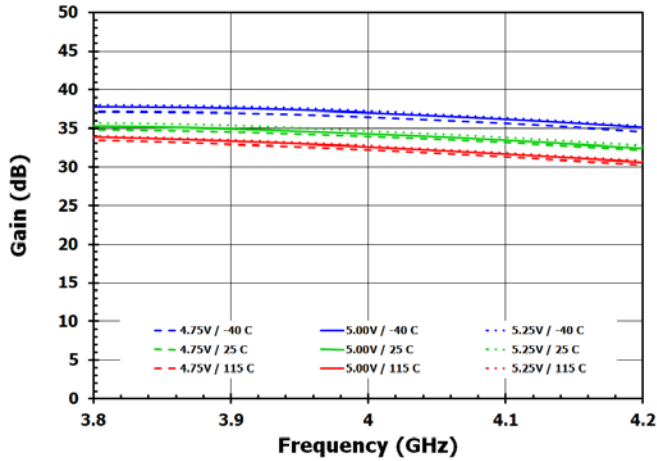

Figure 52. Gain - High Gain Mode

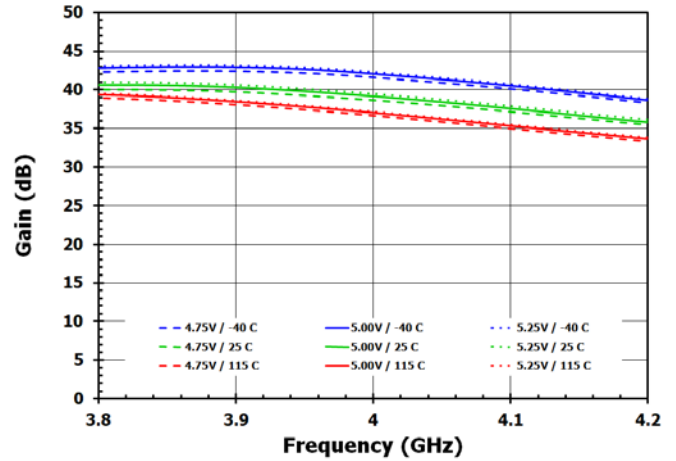

Figure 53. Input Return Loss - Low Gain Mode

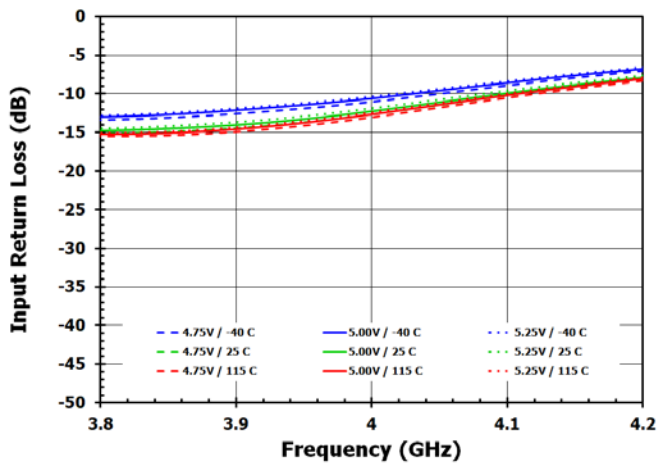

Figure 54. Input Return Loss - High Gain Mode

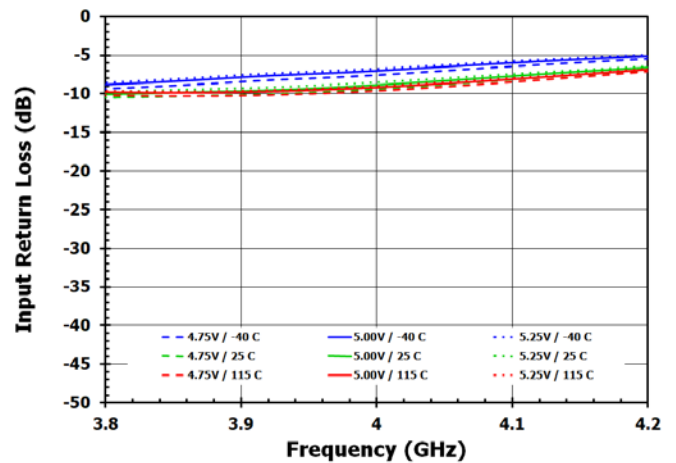

Figure 55. Output Return Loss - Low Gain Mode

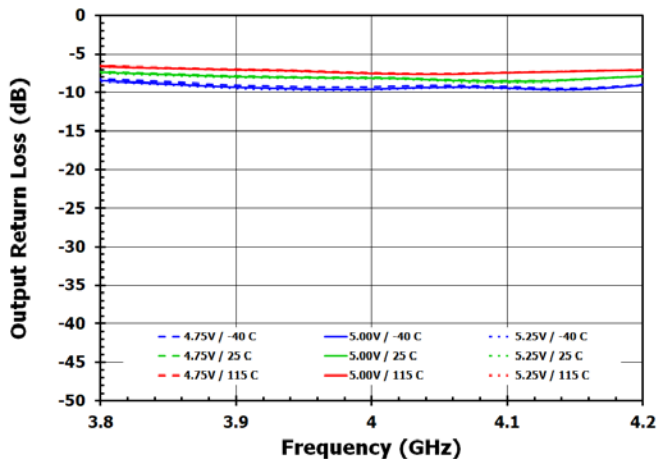

Figure 56. Output Return Loss - High Gain Mode

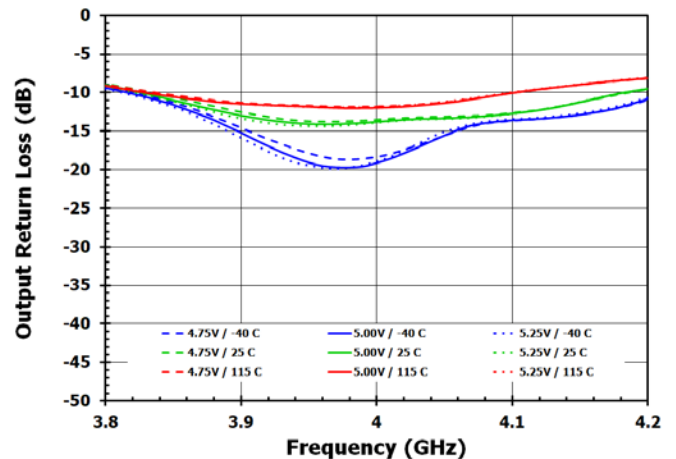

Figure 57. Reverse Isolation - Low Gain Mode

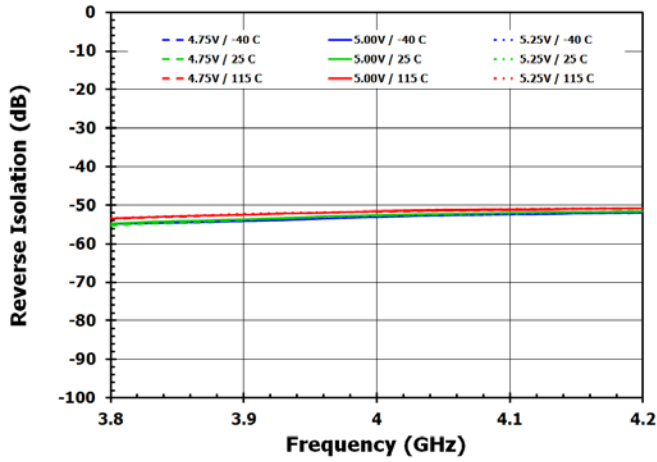

Figure 58. Reverse Isolation - High Gain Mode

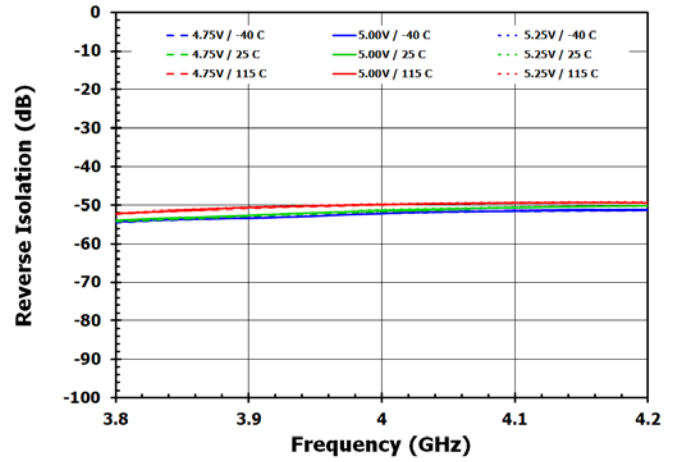

Figure 59. Standby Mode Gain

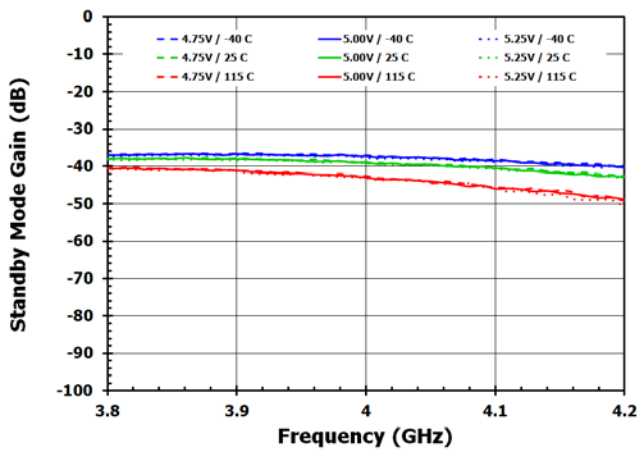

Figure 60. Current versus Power Supply Voltage

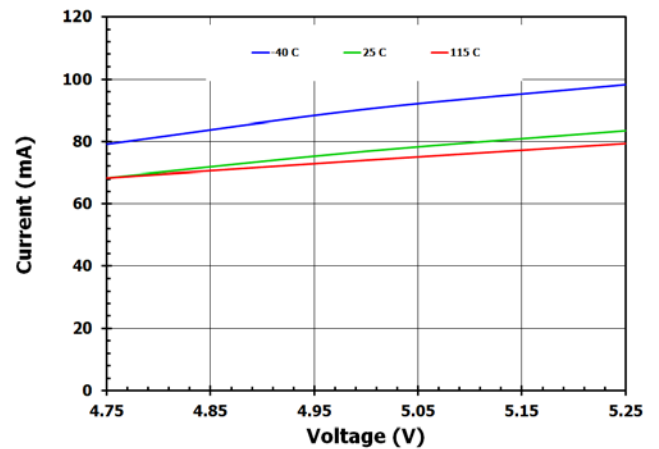

Figure 61. Noise Figure - Low Gain Mode

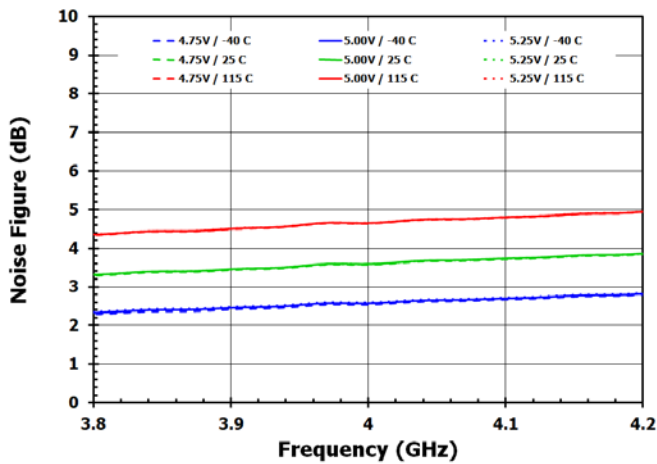

Figure 62. Noise Figure - High Gain Mode

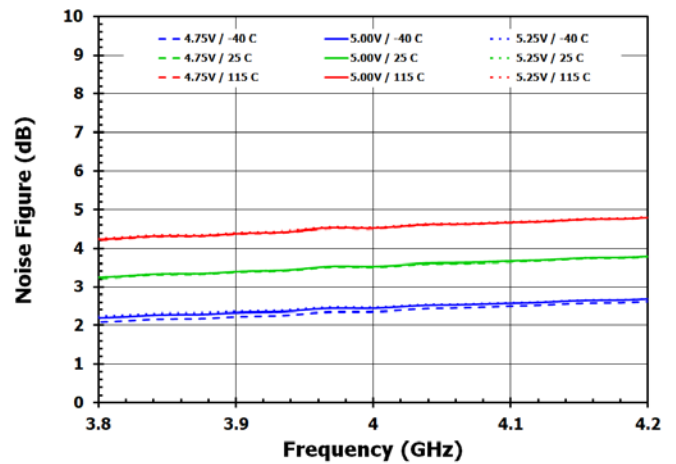

Figure 63. Output IP3 - Low Gain Mode

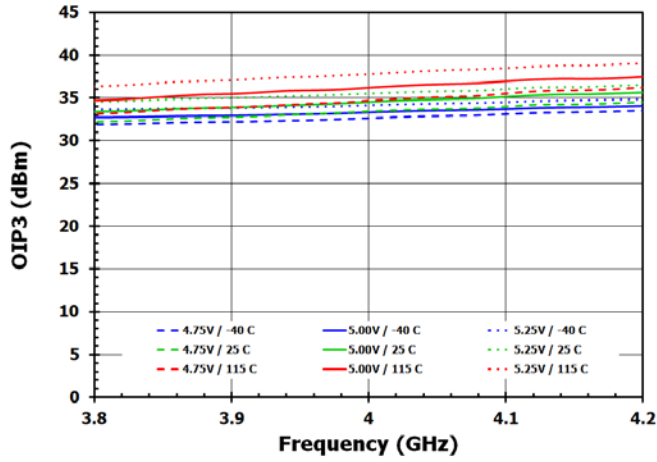

Figure 64. Output IP3 - High Gain Mode

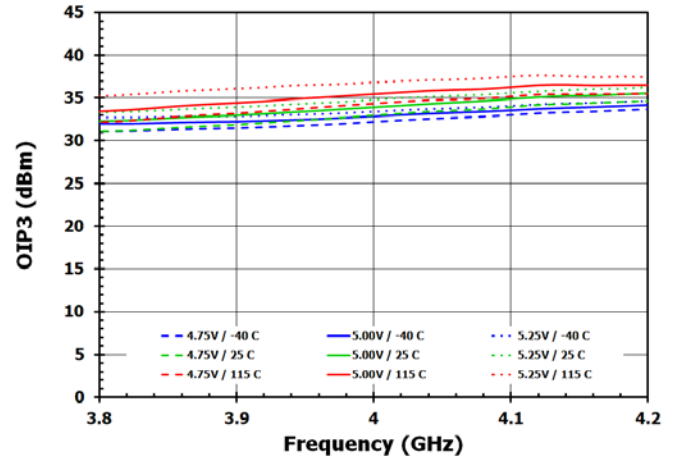

Figure 65. Output P1dB - Low Gain Mode

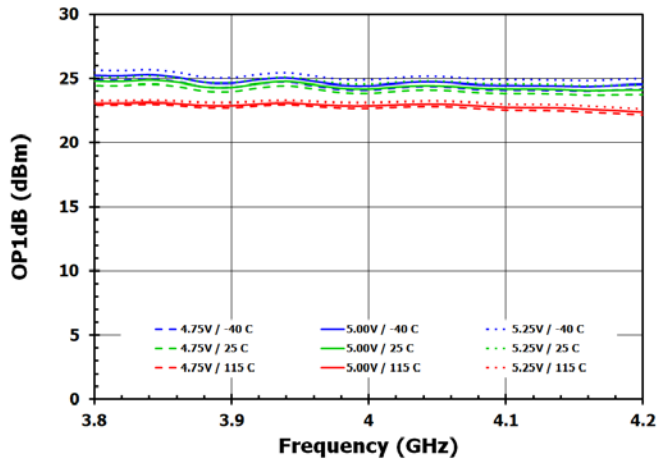
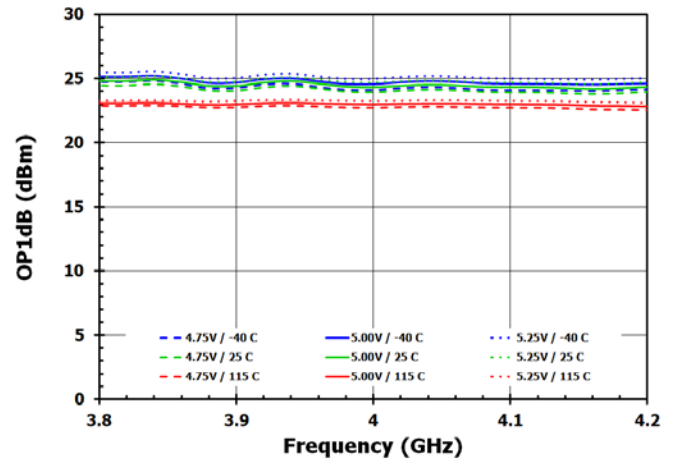

Figure 66. Output P1dB - High Gain Mode



Typical Performance Characteristics (Band 4p7 – 4.4GHz to 5GHz)

Figure 67. Gain - Low Gain Mode

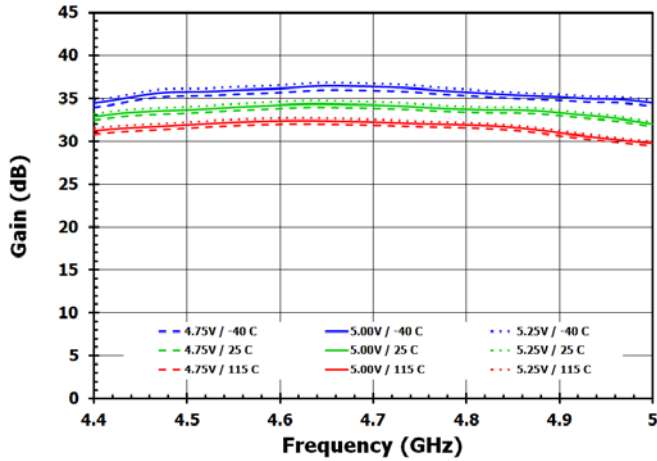

Figure 68. Gain - High Gain Mode

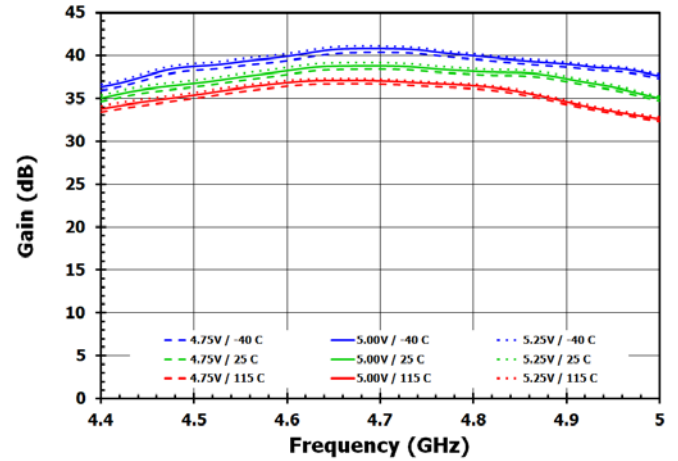

Figure 69. Input Return Loss - Low Gain Mode

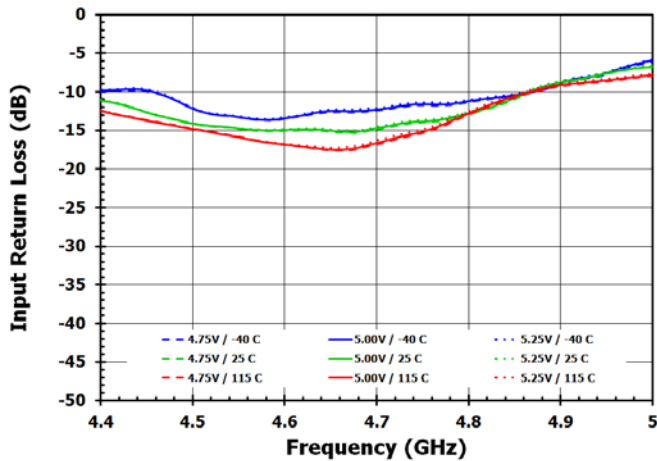

Figure 70. Input Return Loss - High Gain Mode

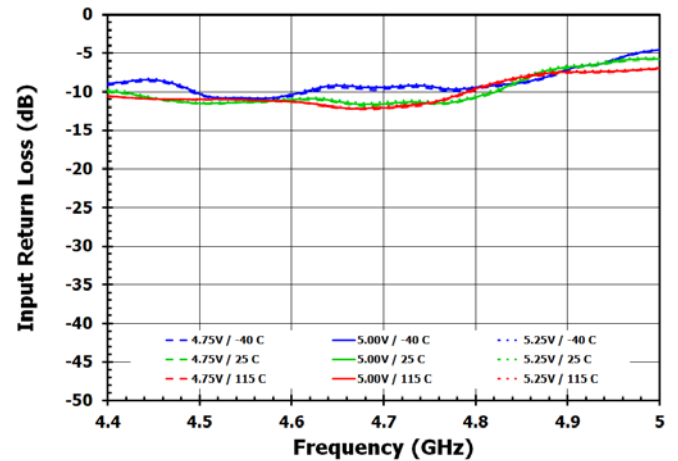

Figure 71. Output Return Loss - Low Gain Mode

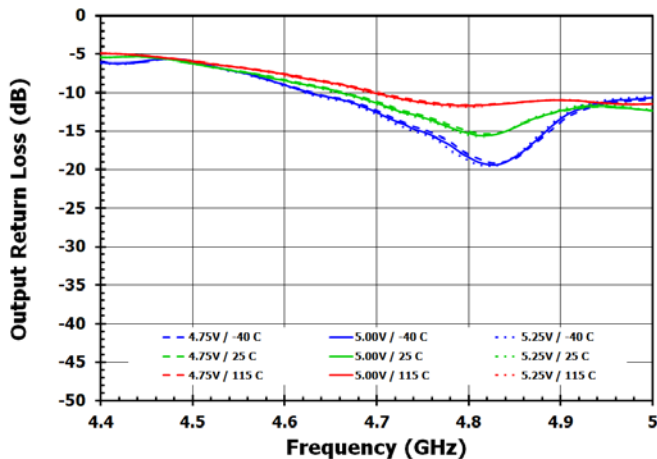

Figure 72. Output Return Loss - High Gain Mode

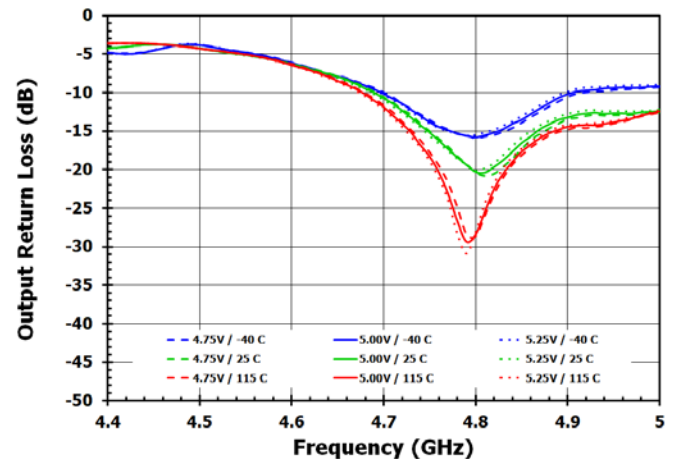

Figure 73. Reverse Isolation - Low Gain Mode

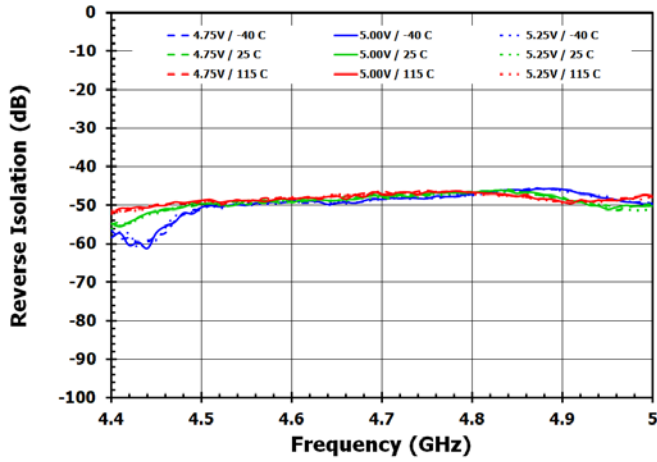

Figure 74. Reverse Isolation - High Gain Mode

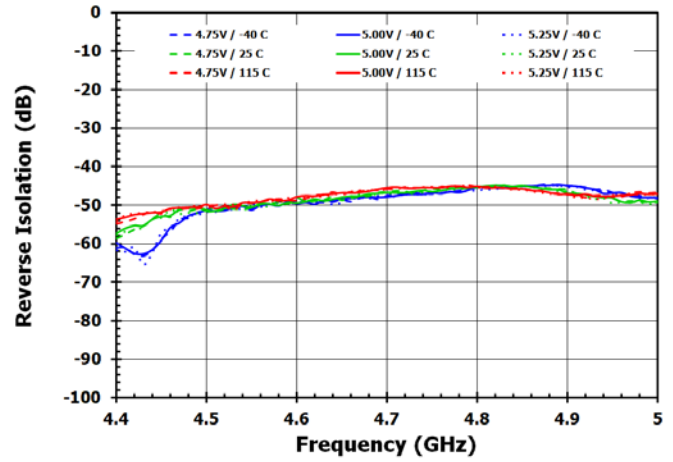

Figure 75. Standby Mode Gain

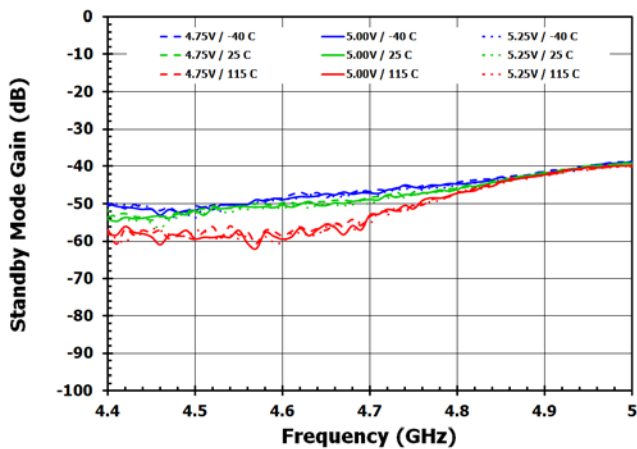

Figure 76. Current versus Power Supply Voltage

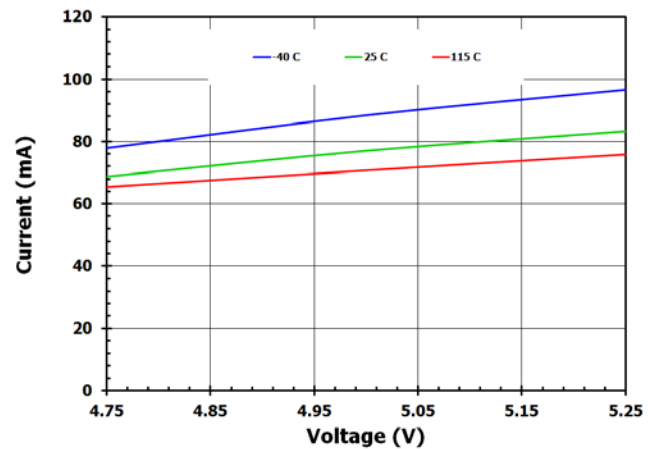

Figure 77. Noise Figure - Low Gain Mode

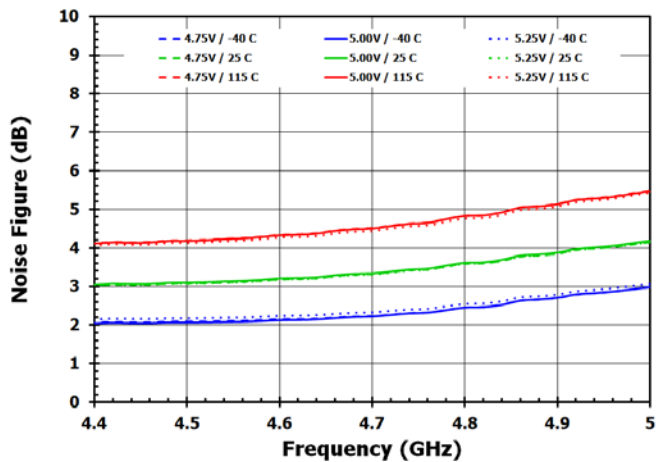

Figure 78. Noise Figure - High Gain Mode

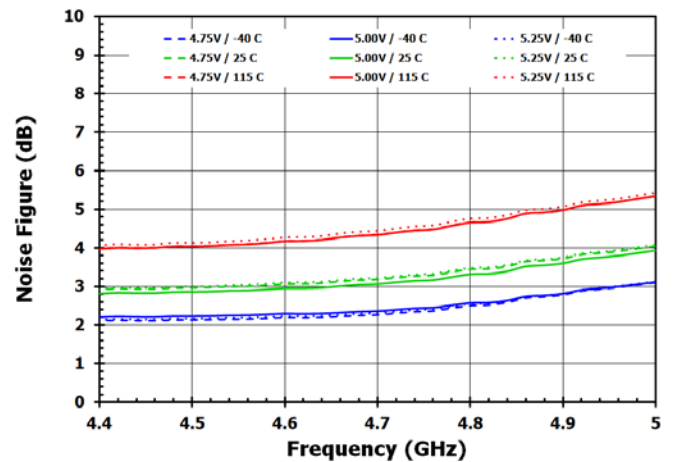

Figure 79. Output IP3 - Low Gain Mode

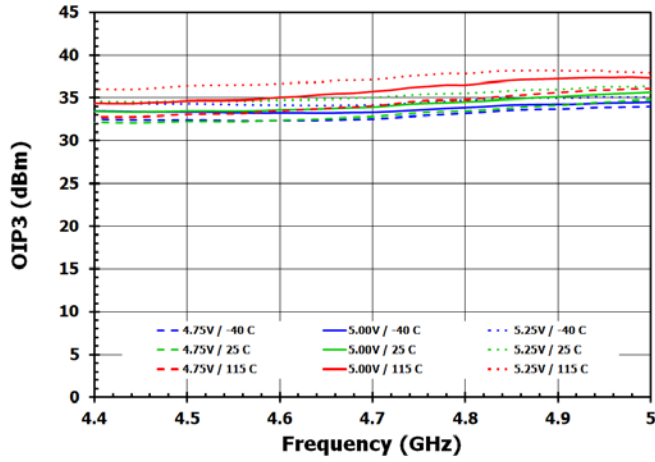

Figure 80. Output IP3 - High Gain Mode

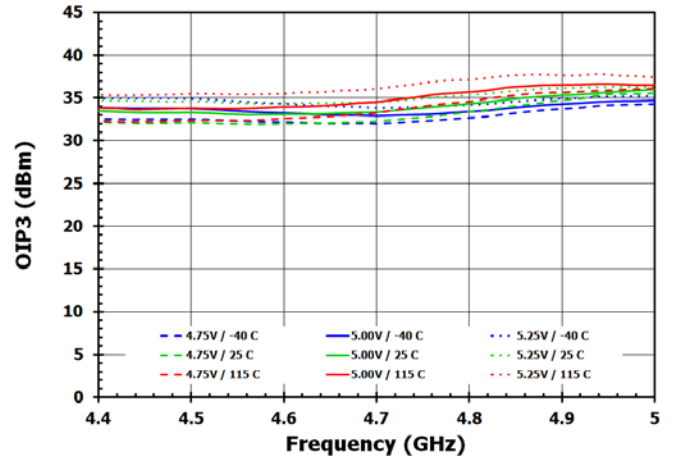

Figure 81. Output P1dB - Low Gain Mode

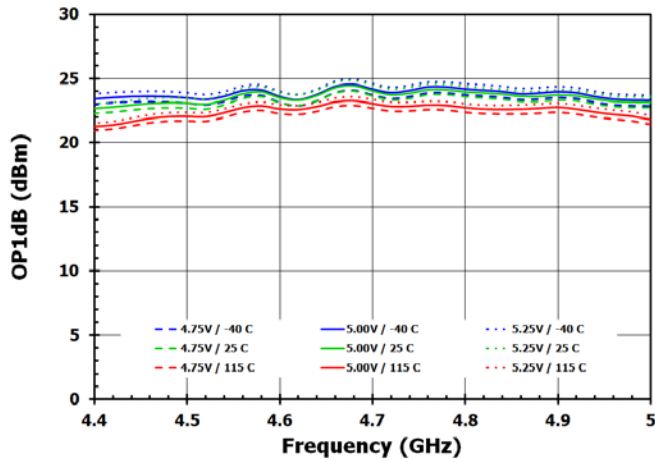
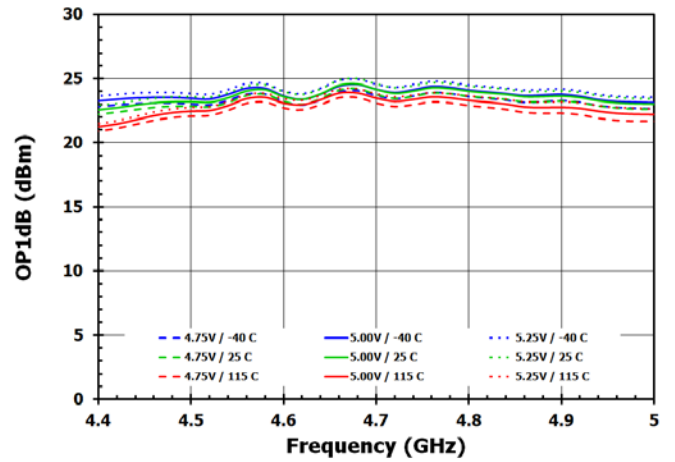

Figure 82. Output P1dB - High Gain Mode



Typical Performance Characteristics (Band 6p0 – 5.92GHz to 6.26GHz)

Figure 83. Gain - High Gain Mode

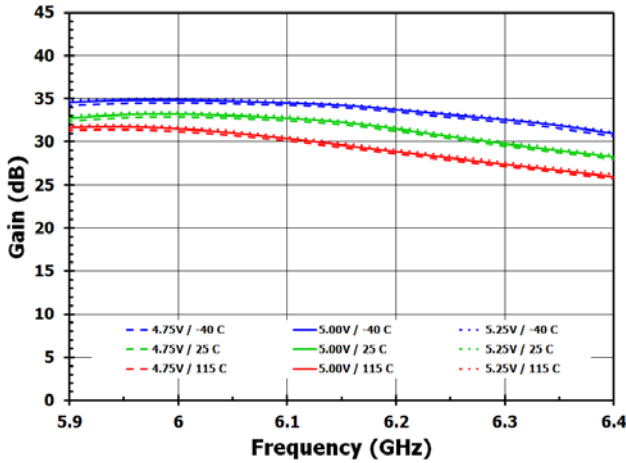

Figure 84. Input Return Loss - High Gain Mode

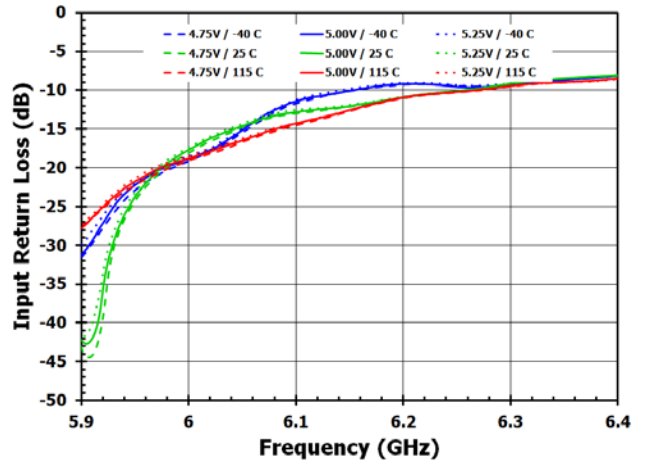

Figure 85. Output Return Loss - High Gain Mode

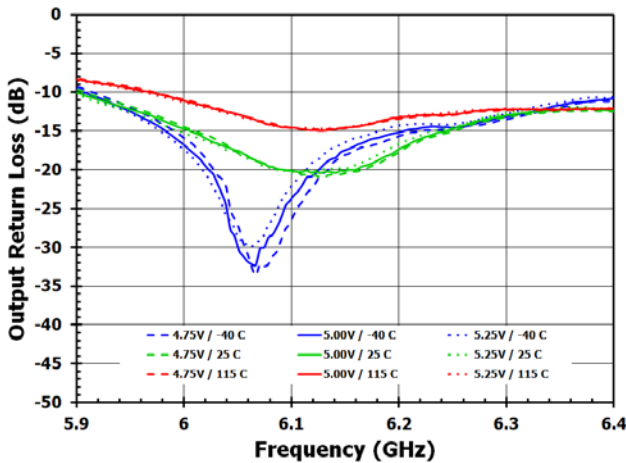

Figure 86. Reverse Isolation - High Gain Mode

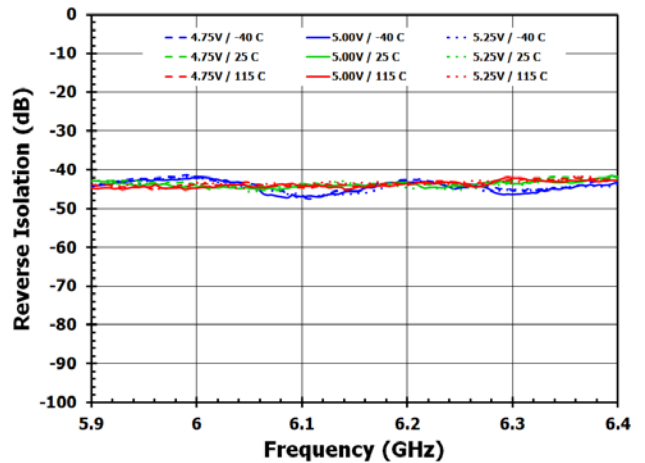

Figure 87. Standby Mode Gain

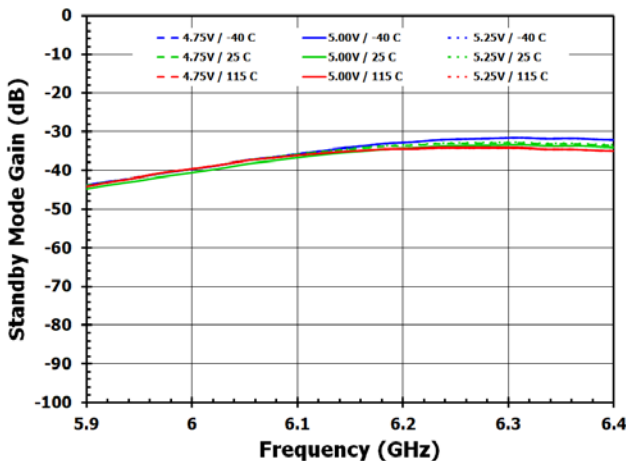

Figure 88. Current versus Power Supply Voltage

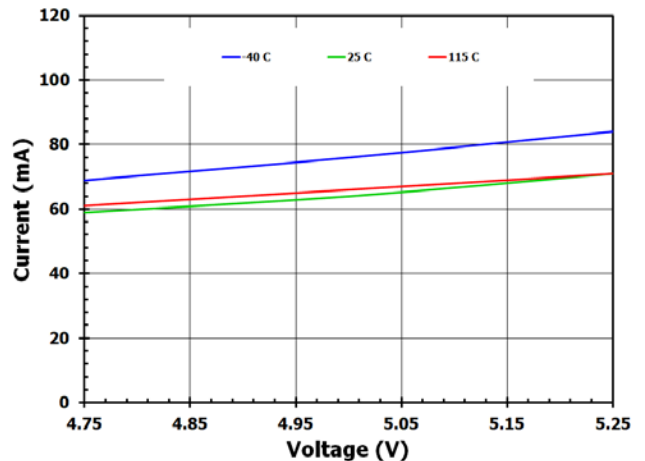

Figure 89. Noise Figure - High Gain Mode

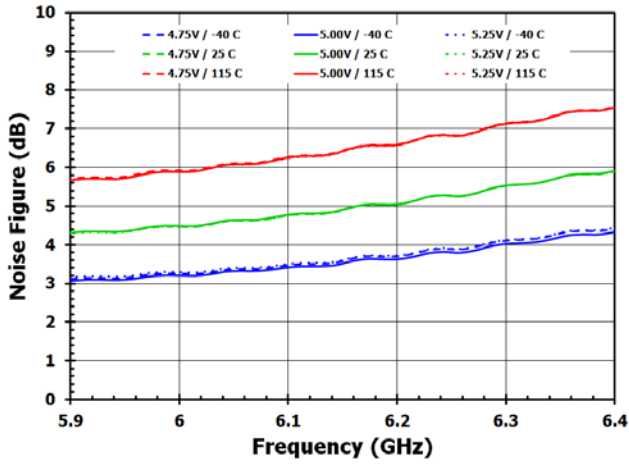

Figure 90. Output IP3 - High Gain Mode

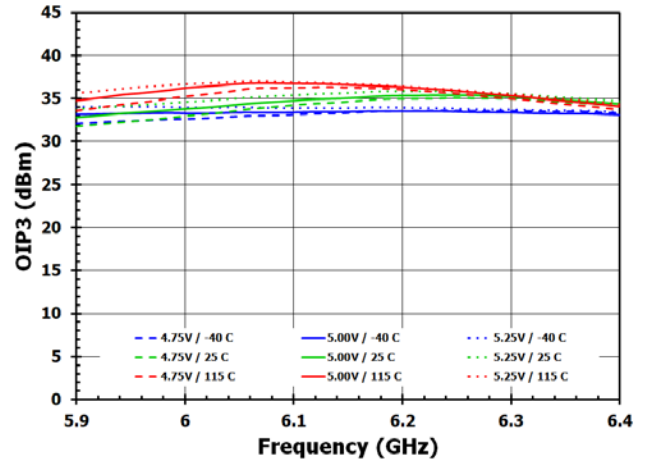
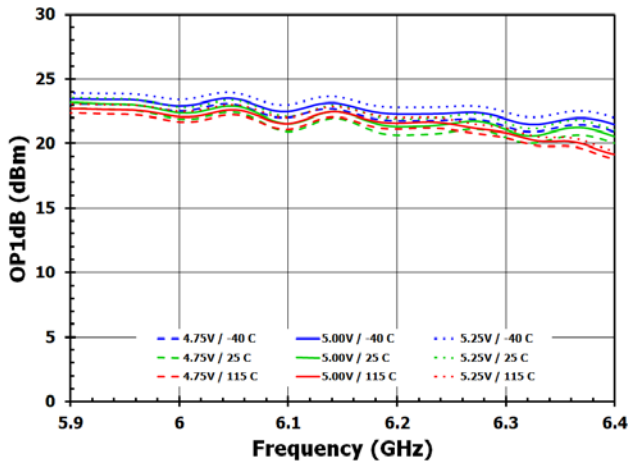

Figure 91. Output P1dB - High Gain Mode



Functional Description

Standby

The F1490 can be turned off for low current consumption. This is done by applying a logic voltage to pin 16 using the following table.

Table 12. Standby Truth Table

STBY	Condition
Logic HIGH / NC	Full operation
Logic LOW	Amplifier OFF

Gain Selection

The F1490 can be selected to be in a High Gain Mode or Low Gain Mode operation. This is done by applying a logic voltage to pin 15 using the following table.

Table 13. Gain Selection Truth Table

GAIN_SEL	Condition
Logic HIGH	High Gain Mode
Logic LOW / NC	Low Gain Mode

Evaluation Kit Picture

Figure 92. Evaluation Kit: Top View

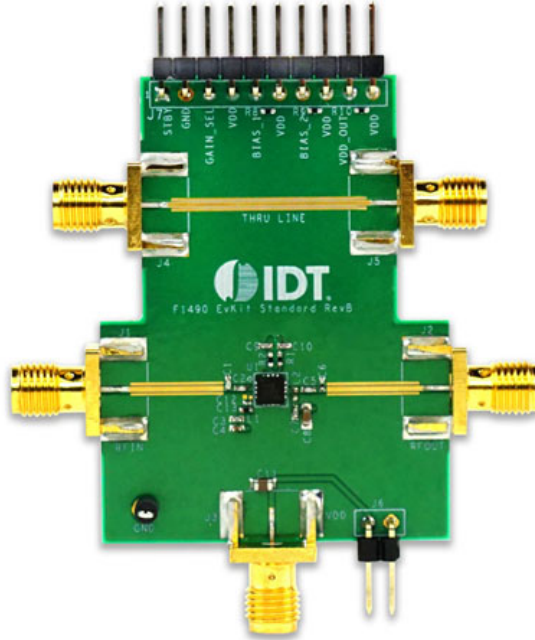
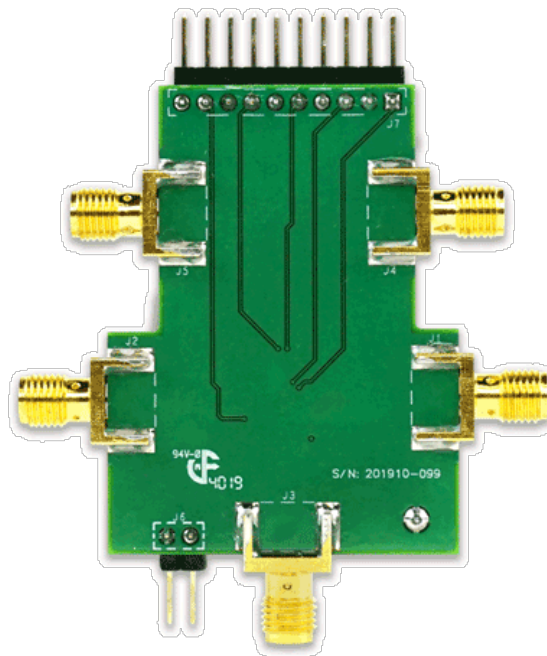
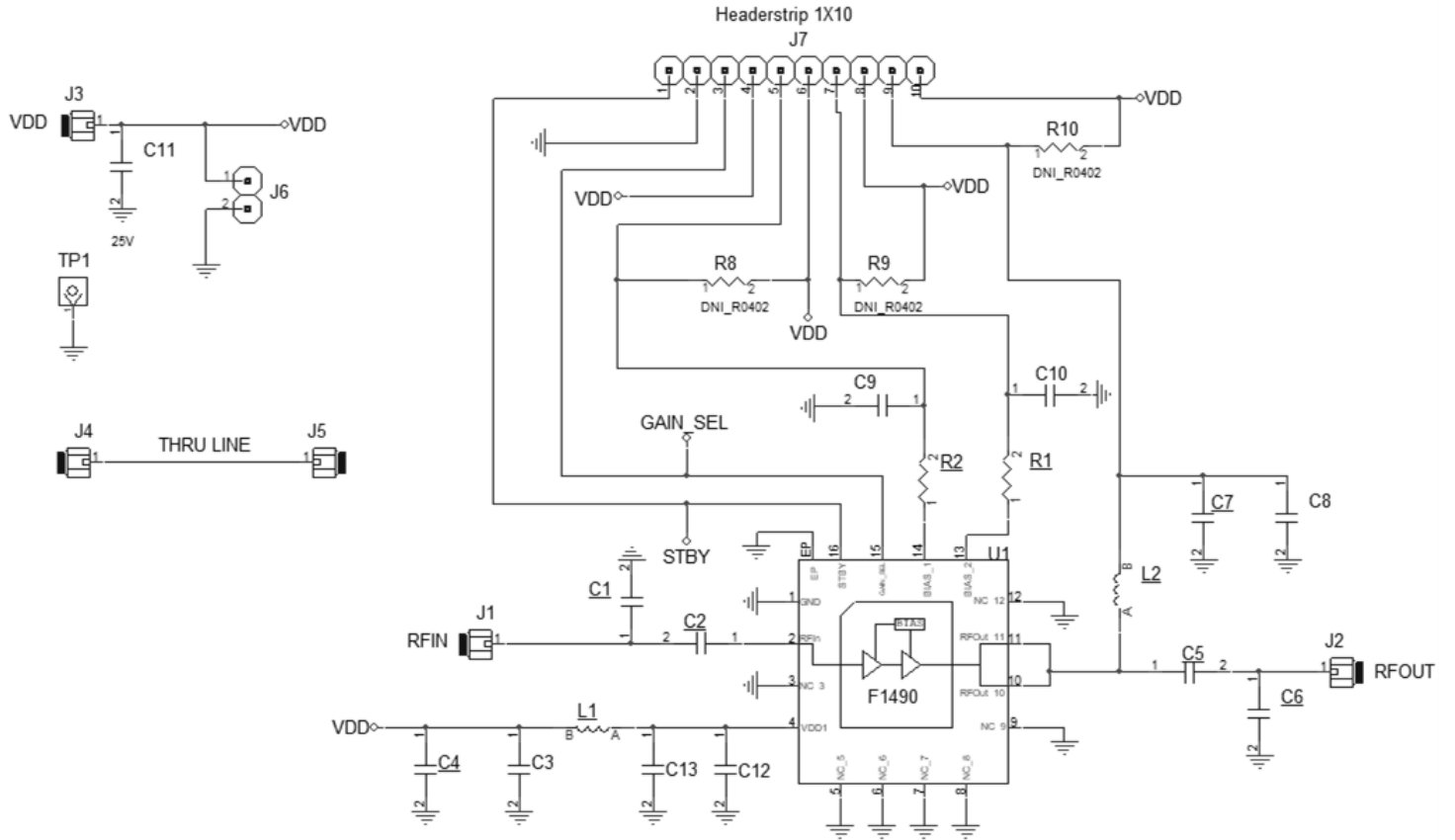

Figure 93. Evaluation Kit: Bottom View



Evaluation Board Schematic

Figure 94. Electrical Schematic



Evaluation Kit BOM – 1.8GHz to 2.2GHz

Table 14. 1.8GHz to 2.2GHz Evaluation Kit Bill of Materials (BOM)^[a]

Part Reference	Qty.	Description	Mfr. Part #	Mfr.
C1	1	1.2pF ±0.1pF, 50V ,COG Surface Mount Capacitor	GJM1555C1H1R2BB01	Murata
C6	1	1.8pF ±0.1pF, 50V ,COG Surface Mount Capacitor	GJM1555C1H1R8BB01	Murata
C2	1	10pF ±0.25pF, 50V ,COG Surface Mount Capacitor	GJM1555C1H100JB01	Murata
C3, C7, C10, C9	4	33pF ±5%, 25V, COG Surface Mount Capacitor	GRM1555C1H330J	Murata
C4	1	0.1uF ±10%, 16V ,X7R Surface Mount Capacitor	GRM155R71C104KA88D	Murata
C8	1	0.1uF ±10%, 50V ,H8L Surface Mount Capacitor	GCM188L81H104KA57D	Murata
C11	1	1uF ±10%, 25V, X5R Surface Mount Capacitor	GRM188R61E105KA12	Murata
C5	1	6.8pF ±0.5pF, 50V , COG Surface Mount Capacitor	GJM1555C1H6R8DB01	Murata
C12, C13	2	DNI		
R1	1	1.5kΩ ±5%, 1/10W	ERJ2GEJJ152	Panasonic
R2	1	1kΩ ±5%, 1/16W	ERJ2GEJJ102	Panasonic
R8, R9, R10	3	0Ω, 1/10W	ERJ2GE0R00X	Panasonic
L2	1	2.2nH ±0.3nH, 300mA, Surface Mount Inductor	LQG15HS2N2S02	Murata
L1	1	1.5nH ±0.3nH, 1A 100mΩ, Surface Mount Inductor	LQG15HN1N5S02D	Murata
J1, J2, J3, J4, J5	5	Connector SMA Jack STR 50ohm Edge Mount	142-0701-851	Cinch Connectivity
J6	1	DNI Headerstrip 1x2		
J7	1	Headerstrip 1x10	0022284103	Molex
TP1	1	Loop, Black, Phosphor Bronze Wire Loop	5001	Keystone electronics
U1	1	F1490, GaAs Pre-Driver Amplifier	F1490	Renesas

[a] This BOM is optimized for low gain mode performance. Refer to application note for recommended high gain BOM.

Evaluation Kit BOM – 2.3GHz to 2.7GHz

Table 15. 2.3GHz to 2.7GHz Evaluation Kit Bill of Materials (BOM)^[a]

Part Reference	Qty.	Description	Mfr. Part #	Mfr.
C1	1	0.8pF ±0.1pF, 50V ,COG Surface Mount Capacitor	GJM1555C1HR80BB01D	Murata
C6	1	0.7pF ±0.1pF, 50V ,COG Surface Mount Capacitor	GJM1555C1HR70BB01D	Murata
C2	1	10pF ±0.25pF, 50V ,COG Surface Mount Capacitor	GJM1555C1H100JB01	Murata
C3, C7, C10, C9	4	33pF ±5%, 25V, COG Surface Mount Capacitor	GRM1555C1H330J	Murata
C4	1	0.1uF ±10%, 16V ,X7R Surface Mount Capacitor	GRM155R71C104KA88D	Murata
C8	1	0.1uF ±10%, 50V ,H8L Surface Mount Capacitor	GCM188L81H104KA57D	Murata
C11	1	1uF ±10%, 25V, X5R Surface Mount Capacitor	GRM188R61E105KA12	Murata
C5	1	22pF ±5%, 50V , COG Surface Mount Capacitor	GRM1555C1H220J	Murata
C12, C13	2	DNI		
R1	1	1.5kΩ ±5%, 1/10W	ERJ2GEJJ152	Panasonic
R2	1	1kΩ ±5%, 1/16W	ERJ2GEJJ102	Panasonic
R8, R9, R10	3	0Ω, 1/10W	ERJ2GE0R00X	Panasonic
L2	1	2.2nH ±0.3nH, 300mA, Surface Mount Inductor	LQG15HS2N2S02	Murata
L1	1	1.5nH ±0.3nH, 1A 100mΩ, Surface Mount Inductor	LQG15HN1N5S02D	Murata
J1, J2, J3, J4, J5	5	Connector SMA Jack STR 50ohm Edge Mount	142-0701-851	Cinch Connectivity
J6	1	DNI Headerstrip 1x2		
J7	1	Headerstrip 1x10	0022284103	Molex
TP1	1	Loop, Black, Phosphor Bronze Wire Loop	5001	Keystone electronics
U1	1	F1490, GaAs Pre-Driver Amplifier	F1490	Renesas

[a] This BOM is optimized for low gain mode performance. Refer to application note for recommended high gain BOM.

Evaluation Kit BOM – 3.3GHz to 3.8GHz

Table 16. 3.3GHz to 3.8GHz Evaluation Kit Bill of Materials (BOM)^[a]

Part Reference	Qty.	Description	Mfr. Part #	Mfr.
C1	1	0.8pF ±0.1pF, 50V ,COG Surface Mount Capacitor	GJM1555C1HR80BB01D	Murata
C6 (inductor)	1	4.3nH ±0.3nH,COG Surface Mount Capacitor	LQG15HS4N3S02D	Murata
C2	1	6pF ±5%, 50V ,COG Surface Mount Capacitor	GJM1555C1H6R0BB01	Murata
C3, C7, C10, C9	4	33pF ±5%, 25V, COG Surface Mount Capacitor	GRM1555C1H330J	Murata
C4	1	0.1uF ±10%, 16V ,X7R Surface Mount Capacitor	GRM155R71C104KA88D	Murata
C8	1	0.1uF ±10%, 25V ,X5R Surface Mount Capacitor	GCM188R71C104KA37D	Murata
C11	1	1uF ±10%, 25V, X5R Surface Mount Capacitor	GRM188R61E105KA12D	Murata
C5	1	1.1pF ±0.1pF, 16V , COG Surface Mount Capacitor	GJM1555C1H1R1BB01D	Murata
C12	1	DNI		
C13	1	33pF ±5%, 25V , COG Surface Mount Capacitor	GRM0335C1E330JA01D	Murata
R1	1	1.8kΩ ±5%, 1/10W	ERJ2GEJ182	Panasonic
R2	1	150Ω ±5%, 1/16W	ERJ2GEJ151	Panasonic
R8, R9, R10, L1	3	0Ω, 1/10W	ERJ2GE0R00X	Panasonic
L2	1	1.8nH ±0.3nH, 300mA, Surface Mount Inductor	LQG15HS1N8S02	Murata
J1, J2, J3	3	Connector SMA Jack STR 50ohm Edge Mount	142-0701-851	Cinch Connectivity
J4, J5	2	DNI		
J6	1	DNI Headerstrip 1x2		
J7	1	Headerstrip 1x10	0022284103	Molex
TP1	1	Loop, Black, Phosphor Bronze Wire Loop	5001	Keystone electronics
U1	1	F1490, GaAs Pre-Driver Amplifier	F1490	Renesas

[a] This BOM is optimized for low gain mode performance. Refer to application note for recommended high gain BOM.

Evaluation Kit BOM – 3.8GHz to 4.2GHz

Table 17. 3.8GHz to 4.2GHz Evaluation Kit Bill of Materials (BOM)^[a]

Part Reference	Qty.	Description	Mfr. Part #	Mfr.
C1	1	0.8pF ±0.1pF, 50V ,COG Surface Mount Capacitor	GJM1555C1HR80BB01D	Murata
C6	1	0.7pF ±0.1pF, 50V ,COG Surface Mount Capacitor	GJM1555C1HR70BB01D	Murata
C2	1	6pF ±5%, 50V ,COG Surface Mount Capacitor	GJM1555C1H6R0BB01	Murata
C3, C7, C10, C9	4	33pF ±5%, 25V, COG Surface Mount Capacitor	GRM1555C1H330J	Murata
C4	1	0.1uF ±10%, 16V ,X7R Surface Mount Capacitor	GRM155R71C104KA88D	Murata
C8	1	0.1uF ±10%, 25V ,X5R Surface Mount Capacitor	GCM188R71C104KA37D	Murata
C11	1	1uF ±10%, 25V, X5R Surface Mount Capacitor	GRM188R61E105KA12D	Murata
C5	1	22pF ±5%, 50V , COG Surface Mount Capacitor	GJM1555C1H220JB01	Murata
C12	1	DNI		
C13	1	33pF ±5%, 25V , COG Surface Mount Capacitor	GRM0335C1E330JA01D	Murata
R1	1	1kΩ ±5%, 1/10W	ERJ2GEJ102	Panasonic
R2	1	150Ω ±5%, 1/16W	ERJ2GEJ151	Panasonic
R8, R9, R10, L1	3	0Ω, 1/10W	ERJ2GE0R00X	Panasonic
L2	1	1.8nH ±0.3nH, 300mA, Surface Mount Inductor	LOG15HS1N8S02	Murata
J1, J2, J3	3	Connector SMA Jack STR 50ohm Edge Mount	142-0701-851	Cinch Connectivity
J4, J5	2	DNI		
J6	1	DNI Headerstrip 1x2		
J7	1	Headerstrip 1x10	0022284103	Molex
TP1	1	Loop, Black, Phosphor Bronze Wire Loop	5001	Keystone electronics
U1	1	F1490, GaAs Pre-Driver Amplifier	F1490	Renesas

[a] This BOM is optimized for low gain mode performance. Refer to application note for recommended high gain BOM.

Evaluation Kit BOM – 4.4GHz to 5GHz

Table 18. 4.4GHz to 5GHz Evaluation Kit Bill of Materials (BOM)^[a]

Part Reference	Qty.	Description	Mfr. Part #	Mfr.
C1	1	0.6pF ±0.1pF, 50V ,COG Surface Mount Capacitor	GJM1555C1HR60BB01	Murata
C6	1	0.6pF ±0.1pF, 50V ,COG Surface Mount Capacitor	GJM1555C1HR60BB01	Murata
C2	1	1.7pF ±0.25pF, 50V ,COG Surface Mount Capacitor	GJM1555C1H1R7BB01	Murata
C3, C7, C10, C9	4	33pF ±5%, 25V, COG Surface Mount Capacitor	GRM1555C1H330J	Murata
C4	1	0.1uF ±10%, 16V ,X7R Surface Mount Capacitor	GRM155R71C104KA88D	Murata
C8	1	0.1uF ±10%, 25V ,X5R Surface Mount Capacitor	GCM188R71C104KA37D	Murata
C11	1	1uF ±10%, 25V, X5R Surface Mount Capacitor	GRM188R61E105KA12D	Murata
C5	1	100pF ±0.1pF, 50V , COG Surface Mount Capacitor	GRM1555C1H101J	Murata
C12	1	DNI		
C13	1	1.8pF ±0.1dB, 50V , COG Surface Mount Capacitor	GJM1555C1H1R8BB01	Murata
R1	1	1.8kΩ ±5%, 1/10W	ERJ2GEJ182	Panasonic
R2	1	150Ω ±5%, 1/16W	ERJ2GEJ151	Panasonic
R8, R9, R10	3	0Ω, 1/10W	ERJ2GE0R00X	Panasonic
L1		10nH ±5%, 300mA, Surface Mount Inductor	LOG15HS10NJ02	Murata
L2	1	1.0nH ±0.3nH, 300mA, Surface Mount Inductor	LOG15HS1N0S02	Murata
J1, J2, J3	3	Connector SMA Jack STR 50ohm Edge Mount	142-0701-851	Cinch Connectivity
J4, J5	2	DNI		
J6	1	DNI Headerstrip 1x2		
J7	1	Headerstrip 1x10	0022284103	Molex
TP1	1	Loop, Black, Phosphor Bronze Wire Loop	5001	Keystone electronics
U1	1	F1490, GaAs Pre-Driver Amplifier	F1490	Renesas

[a] This BOM is optimized for low gain mode performance. Refer to application note for recommended high gain BOM.

Evaluation Board Schematic for 5.92GHz – 6.26GHz BOM

Figure 95. Electrical Schematic for 5.92GHz - 6.26GHz BOM

Note: Specifications shown for 5.92GHz to 6.26GHz require accommodating additional shunt component C14 that is not included in the F1490 Evaluation Kit.

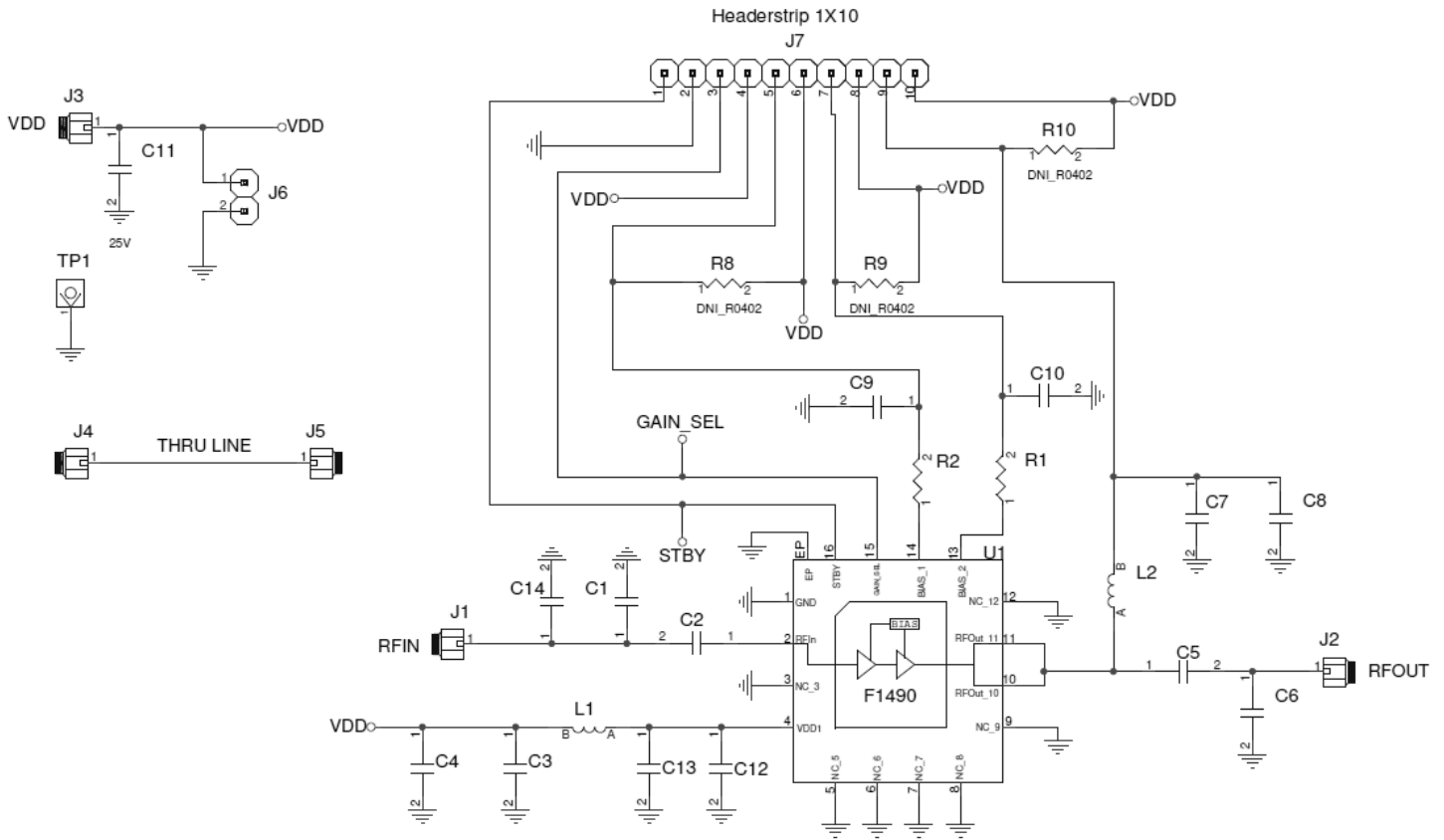

Evaluation Kit BOM – 5.92GHz to 6.26GHz

Table 19. 5.92GHz to 6.26GHz Evaluation Kit Bill of Materials (BOM)^[a]

Part Reference	Qty.	Description	Mfr. Part #	Mfr.
C1	1	0.4pF ±0.1pF, 50V ,COG Surface Mount Capacitor	GJM1555C1HR40BB01	Murata
C6	1	0.5pF ±0.1pF, 50V ,COG Surface Mount Capacitor	GJM1555C1HR50BB01	Murata
C2	1	0.6pF ±0.1pF, 50V ,COG Surface Mount Capacitor	GJM1555C1HR60BB01	Murata
C3, C7, C10, C9	4	33pF ±5%, 25V, COG Surface Mount Capacitor	GRM1555C1H330J	Murata
C4	1	0.1uF ±10%, 16V ,X7R Surface Mount Capacitor	GRM155R71C104KA88D	Murata
C8	1	0.1uF ±10%, 25V ,X5R Surface Mount Capacitor	GCM188R71C104KA37D	Murata
C11	1	1uF ±10%, 25V, X5R Surface Mount Capacitor	GRM188R61E105KA12D	Murata
C5	1	2.5pF ±0.1pF, 50V , COG Surface Mount Capacitor	GRM1555C1H2R5BB01	Murata
C12	1	0.3pF ±0.1pF, 50V , COG Surface Mount Capacitor	GJM1555C1HR30BB01	Murata
C13	1	DNI		
C14	1	1.0kΩ ±5%, 1/10W	ERJ2GEJ102	Panasonic
R1	1	1.8kΩ ±5%, 1/10W	ERJ2GEJ182	Panasonic
R2	1	150Ω ±5%, 1/16W	ERJ2GEJ151	Panasonic
R8, R9, R10	3	0Ω, 1/10W	ERJ2GE0R00X	Panasonic
L1		68nH ±5%, 300mA, Surface Mount Inductor	L-07C68NJV6S	Johanson Technology
L2	1	1.0nH ±0.3nH, 300mA, Surface Mount Inductor	L-07C1N0SV6S	Johanson Technology
J1, J2, J3	3	Connector SMA Jack STR 50ohm Edge Mount	142-0701-851	Cinch Connectivity
J4, J5	2	DNI		
J6	1	DNI Headerstrip 1x2		
J7	1	Headerstrip 1x10	0022284103	Molex
TP1	1	Loop, Black, Phosphor Bronze Wire Loop	5001	Keystone electronics
U1	1	F1490, GaAs Pre-Driver Amplifier	F1490	Renesas

[a] This BOM is optimized for High gain mode performance.

Power Supplies

A common VDD power supply should be used for all power supply pins. To minimize noise and fast transients, add de-coupling capacitors to all supply pins. Supply noise can degrade noise figure. In addition, all control pins should remain at 0V ($\pm 0.3V$) while the supply voltage ramps or while it returns to zero.

If control signal integrity is a concern and clean signals cannot be guaranteed due to overshoot, undershoot, ringing, etc., the following circuit is recommended at the input of each control pin. This applies to the GAIN_SEL pin (15) and STBY pin (16) as shown below. Note the recommended resistor and capacitor values do not necessarily match the EV Kit BOM for the case of poor control signal integrity. For multiple devices driven by a single control line, the component values will need to be adjusted accordingly so as not to load down the control line.

Figure 96. Control Pin Interface for Signal Integrity

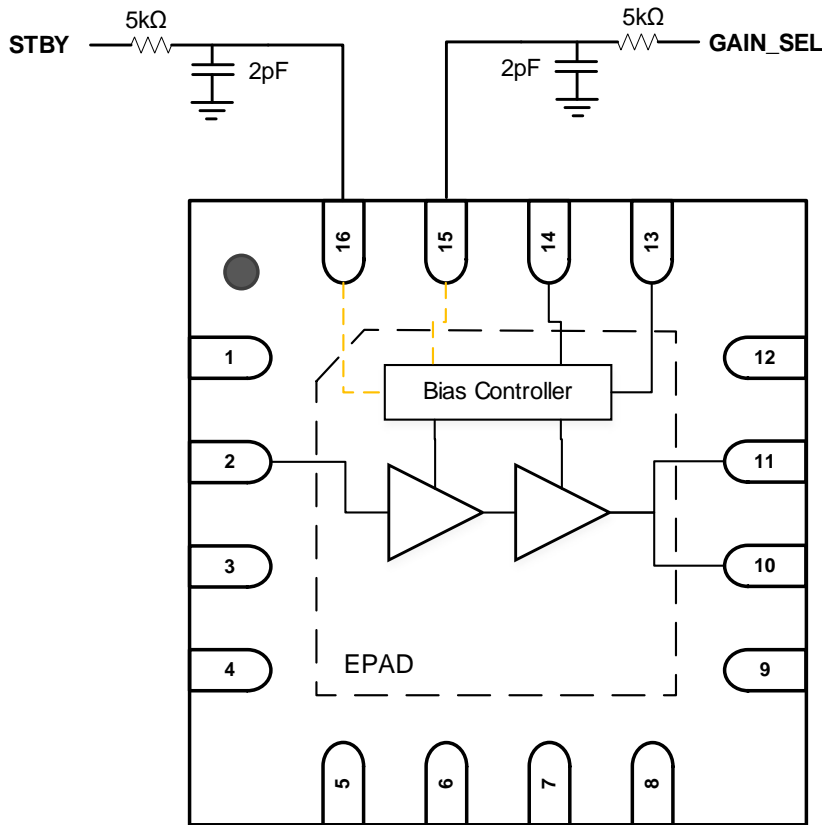

Package Outline Drawings

The package outline drawings are located at the end of this document and are accessible from the Renesas website. The package information is the most current data available and is subject to change without revision of this document.

Ordering Information

Orderable Part Number	Package	MSL Rating	Shipping Packaging	Temperature
F1490NLGA	3 × 3 × 0.9 mm 16-VFOFPN	MSL 1	Tray	-40° to +115°C
F1490NLGA8	3 × 3 × 0.9 mm 16-VFOFPN	MSL 1	Tape and Reel	-40° to +115°C
F1490EVB-2P0	Evaluation Board for 1.8GHz to 2.2GHz Band			
F1490EVB-2P5	Evaluation Board for 2.3GHz to 2.7GHz Band			
F1490EVB-3P6	Evaluation Board for 3.3GHz to 3.8GHz Band			
F1490EVB-4P0	Evaluation Board for 3.8GHz to 4.2GHz Band			
F1490EVB-4P7	Evaluation Board for 4.4GHz to 5GHz Band			
F1490EVB-6P0	Evaluation Board for 5.92GHz to 6.26GHz Band			

Marking Diagram

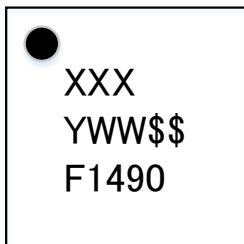

- Line 1: "XXX" represents the last three digits of the lot number.
- Line 2: "YWW" has one digit for the year and two digits for week that the part was assembled. "\$\$" denotes the assembly site.
- Line 3: "F1490" is the part number.

Revision History

Revision Date	Description of Change
November 15, 2021	<ul style="list-style-type: none"> ▪ Added specifications for 2GHz, 4 GHz, 4.7GHz, and 6GHz bands. ▪ Operating frequency range extended to 1.8GHz – 6.4GHz.
August 17, 2020	Updated pins 1 and 3 descriptions in Table 1.
May 1, 2020	Added Application Information for Power Supplies.
April 9, 2020	Updated MSL rating.
February 18, 2020	Initial release.

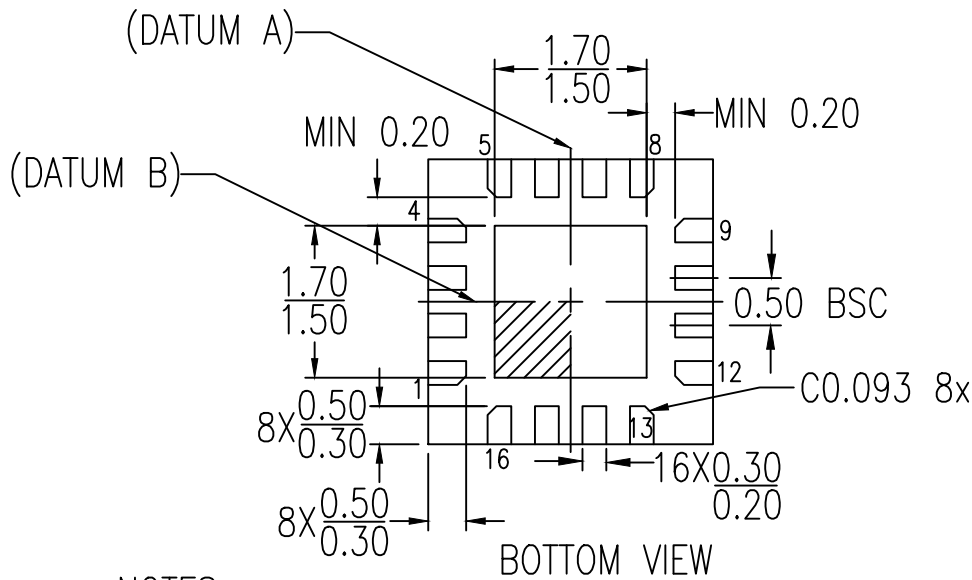
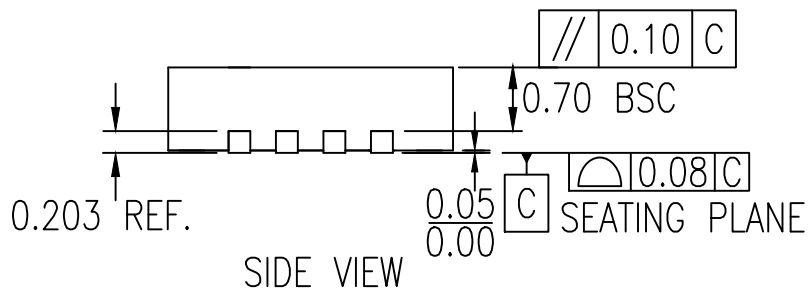
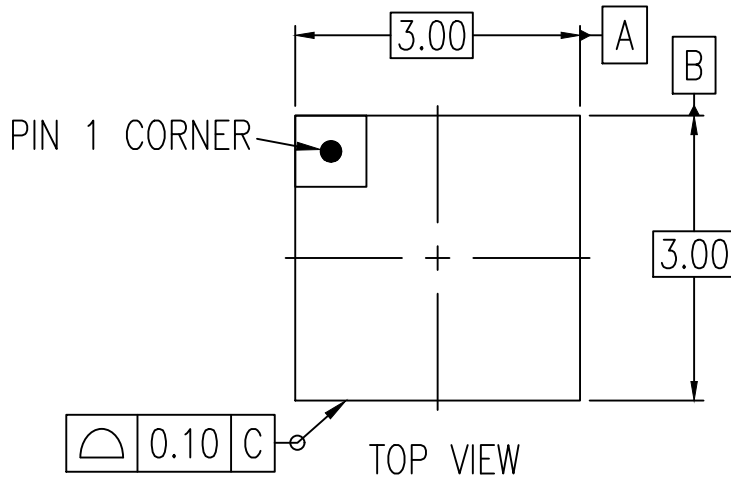

NOTES:

1. ALL DIMENSIONS ARE IN MM.
2. ALL DIMENSIONING AND TOLERANCING CONFORM TO ASME Y14.5-2009
3. PIN 1 LOCATION IDENTIFIER IS EITHER BY CHAMFER OR NOTCH

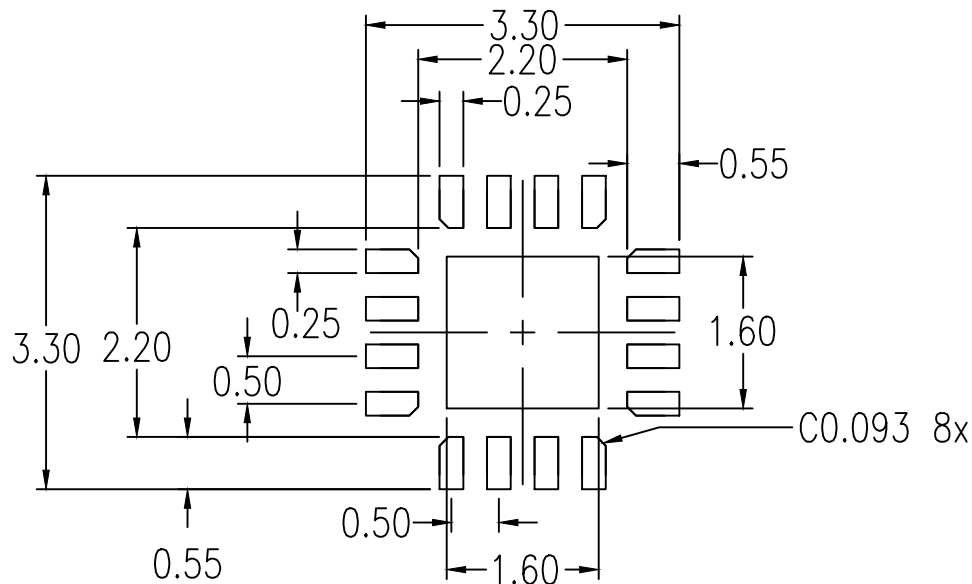

RECOMMENDED LAND PATTERN

NOTES:

1. ALL DIMENSIONS ARE IN MM. ANGLES IN DEGREES
2. TOP DOWN VIEW—AS VIEWED ON PCB
3. LAND PATTERN RECOMMENDATION IS PER IPC-7351B GENERIC REQUIREMENT FOR SURFACE MOUNT DESIGN AND LAND PATTERN

Package Revision History		
Date Created	Rev No.	Description
Sept 13, 2018	Rev 03	Change QFN to VFQFPN
Aug 18, 2020	Rev 04	Add Chamfer Dimension

IMPORTANT NOTICE AND DISCLAIMER

RENESAS ELECTRONICS CORPORATION AND ITS SUBSIDIARIES (“RENESAS”) PROVIDES TECHNICAL SPECIFICATIONS AND RELIABILITY DATA (INCLUDING DATASHEETS), DESIGN RESOURCES (INCLUDING REFERENCE DESIGNS), APPLICATION OR OTHER DESIGN ADVICE, WEB TOOLS, SAFETY INFORMATION, AND OTHER RESOURCES “AS IS” AND WITH ALL FAULTS, AND DISCLAIMS ALL WARRANTIES, EXPRESS OR IMPLIED, INCLUDING, WITHOUT LIMITATION, ANY IMPLIED WARRANTIES OF MERCHANTABILITY, FITNESS FOR A PARTICULAR PURPOSE, OR NON-INFRINGEMENT OF THIRD PARTY INTELLECTUAL PROPERTY RIGHTS.

These resources are intended for developers skilled in the art designing with Renesas products. You are solely responsible for (1) selecting the appropriate products for your application, (2) designing, validating, and testing your application, and (3) ensuring your application meets applicable standards, and any other safety, security, or other requirements. These resources are subject to change without notice. Renesas grants you permission to use these resources only for development of an application that uses Renesas products. Other reproduction or use of these resources is strictly prohibited. No license is granted to any other Renesas intellectual property or to any third party intellectual property. Renesas disclaims responsibility for, and you will fully indemnify Renesas and its representatives against, any claims, damages, costs, losses, or liabilities arising out of your use of these resources. Renesas' products are provided only subject to Renesas' Terms and Conditions of Sale or other applicable terms agreed to in writing. No use of any Renesas resources expands or otherwise alters any applicable warranties or warranty disclaimers for these products.

(Rev.1.0 Mar 2020)

Corporate Headquarters

TOYOSU FORESIA, 3-2-24 Toyosu,
Koto-ku, Tokyo 135-0061, Japan
www.renesas.com

Contact Information

For further information on a product, technology, the most up-to-date version of a document, or your nearest sales office, please visit:
www.renesas.com/contact/

Trademarks

Renesas and the Renesas logo are trademarks of Renesas Electronics Corporation. All trademarks and registered trademarks are the property of their respective owners.