

---

# CANopen Slave Device

## CAN-2053C

### Application User's Manual

#### **Warranty**

Without contrived damage, all products manufactured by ICP DAS are warranted in one year from the date of delivery to customers.

#### **Warning**

ICP DAS revises the manual at any time without notice. However, no responsibility is taken by ICP DAS unless infringement act imperils to patents of the third parties.

#### **Copyright**

Copyright © 2010 is reserved by ICP DAS.

#### **Trademark**

The brand name ICP DAS as a trademark is registered, and can be used by other authorized companies.

---

## Contents

<b>1</b>	<b>Introduction.....</b>	<b>3</b>
1.1	<b>Overview .....</b>	<b>3</b>
1.2	<b>Hardware Specifications .....</b>	<b>4</b>
1.3	<b>Features.....</b>	<b>5</b>
1.4	<b>Application .....</b>	<b>6</b>
<b>2</b>	<b>Hardware .....</b>	<b>7</b>
2.1	<b>Structure .....</b>	<b>7</b>
2.2	<b>Node ID &amp; Baud Rate Rotary Switch .....</b>	<b>8</b>
2.3	<b>I/O Pair-connection Mode.....</b>	<b>9</b>
2.4	<b>LED Description.....</b>	<b>11</b>
2.5	<b>PIN Assignment .....</b>	<b>12</b>
2.6	<b>Wire Connection .....</b>	<b>13</b>
<b>3</b>	<b>Object Dictionary .....</b>	<b>14</b>
3.1	<b>Object List .....</b>	<b>14</b>
3.2	<b>Store and Restore Object.....</b>	<b>18</b>
3.3	<b>Application Object .....</b>	<b>19</b>
3.4	<b>Default PDO Mapping .....</b>	<b>22</b>

---

# 1 Introduction

## 1.1 Overview

CAN-2053C is a CANopen slave module and it has 16 Digital input channels with 4 commons type. It can be used to develop powerful and cost effective digital control system.



Figure 1-1 CAN-2053C

---

## 1.2 Hardware Specifications

### Digital Input:

- Input Channels: 16 (Sink/Source)
- Input Type: 4 commons for all inputs.
- On Voltage Level: +3.5 ~ +30 V<sub>DC</sub>.
- Off Voltage Level: +1 V<sub>DC</sub> max.
- Input Impedance: 3 k $\Omega$ , 0.3 W
- Intra-module Isolation, Field to Logic: 3750 Vrms.
- ESD Protection: 4 kV Contact for each channel.

### Others:

- CANopen Status: 3 LEDs for PWR / RUN / ERR.
- Terminal Resistor: 1 LED as terminator resistor indicators
- DI LED: 16 LEDs as digital input indicators.
- Power Requirement: +10 ~ +30 V<sub>DC</sub>, 1.2 W.
- Operating Temperature: -25 ~ +75 °C.
- Storage Temperature: -30 ~ +80 °C.
- Humidity: 10 to 90% RH, Non-condensing.
- Dimensions: 32.3 mm x 99 mm x 77.5 mm (W x L x H) Detail.

---

## 1.3 Features

- Standard CANopen general I/O slave devices.
- CANopen Version: DS-301, v4.02.
- Device Profile: DSP-401, v2.1
- Support I/O pair-connection mechanism.
- Provide normal/polarity 16 DI channels
- CANopen transfer rate: 10 kbps, 20 kbps, 50 kbps, 125 kbps, 250 kbps, 500 kbps, 800 kbps, 1000 kbps.
- Support maximum CANopen slave devices Node-ID up to 99.
- Set Node-ID 0 for firmware update (after version 1.20-20111227).
  - Firmware updates tools: I-7530 series, I-7540D series, I-7565 series, PISO-CM100 series, and PISO-CAN series.
- Support NMT, PDO, SDO, EMCY, SYNC, Guarding, and Heartbeat protocol.
- Pass the validation of CANopen conformance test
- Provide EDS file for CANopen master interface

---

## 1.4 Application

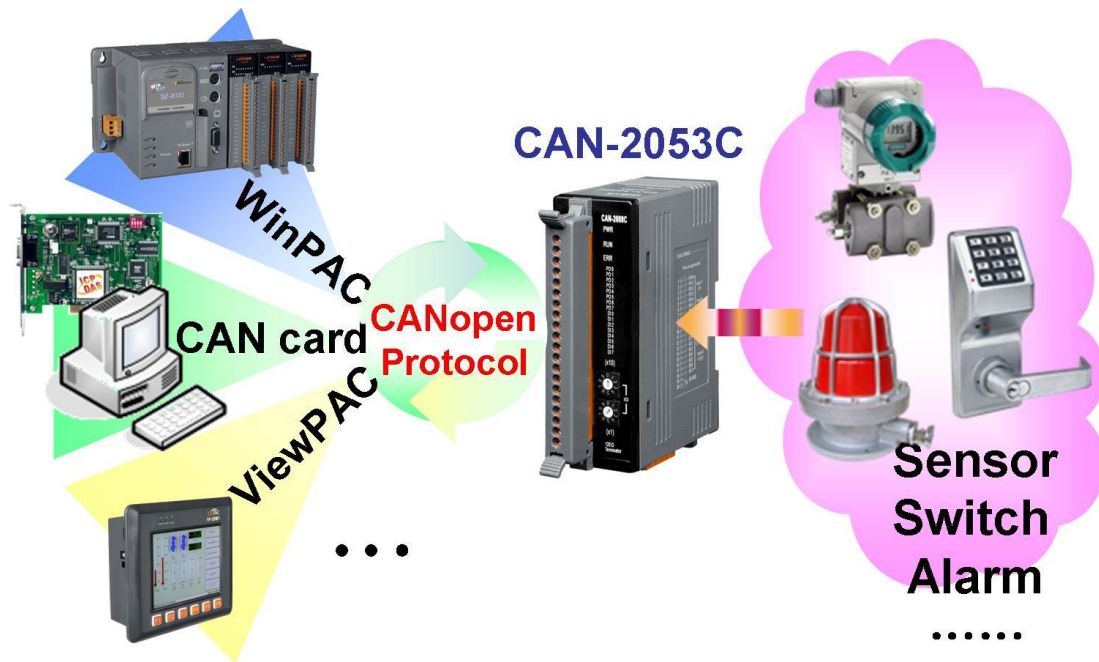

Figure 1-2 Application Structure

---

## 2 Hardware

### 2.1 Structure

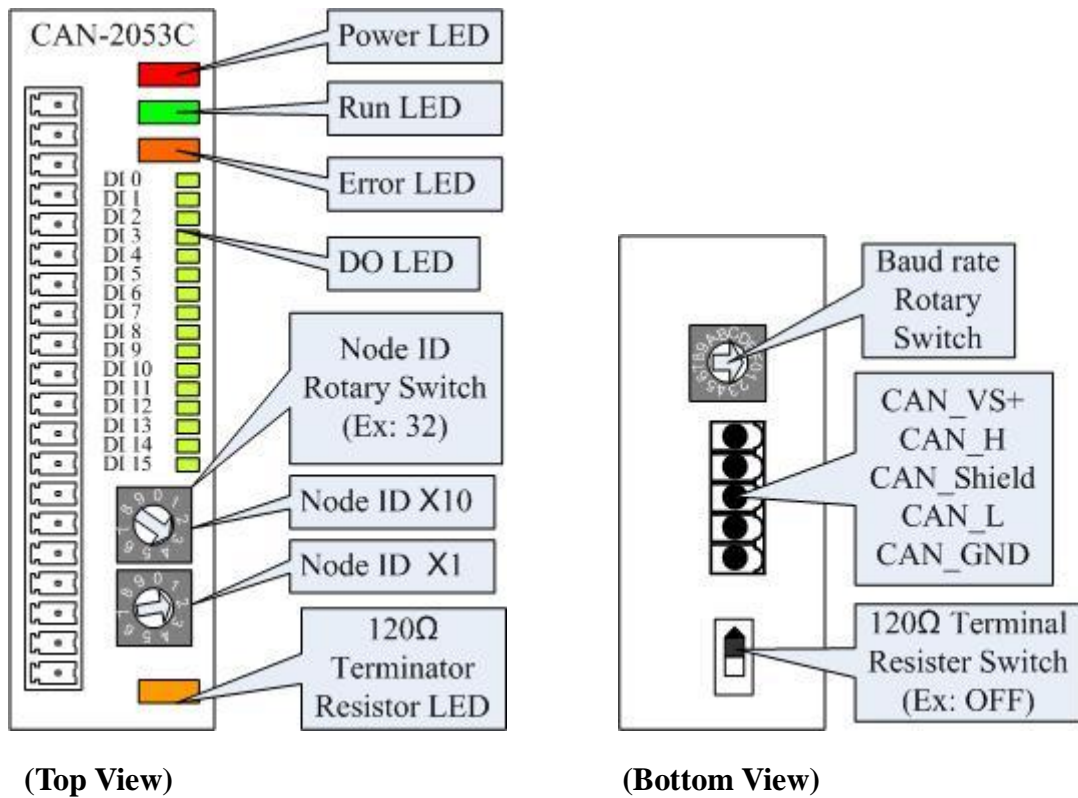
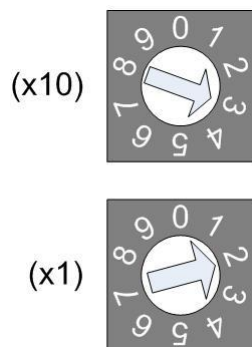

Figure 2-1 CAN-2053C layout of LED, connect, and switch

## 2.2 Node ID & Baud Rate Rotary Switch

The rotary switches of node ID configure the node ID of CAN-2053C module. These two switches are for the tens digit and the units digit of the node ID. The node ID value of this demo picture is 32.



**Figure 2-2 Node ID rotary switch**

The rotary switch of baud rate handles the CAN baud rate of CAN-2053C module. The value of baud rate switch from 0 ~ 7 are normal CANopen mode, and 8 ~ F are I/O pair-connection mode. About the I/O pair-connection mode please refer to section 2.3. The relationship between the rotary switch value and the practical baud rate is presented in the following table.



**Figure 2-3 Baud rate rotary switch**

Rotary Switch Value	Rotary Switch Value of I/O Pair-connection	Baud Rate (k bps)
0	8	10
1	9	20
2	A	50
3	B	125
4	C	250
5	D	500
6	E	800
7	F	1000

**Table 2-1 Baud rate and rotary switch**



---

## 2.3 I/O Pair-connection Mode

The CAN-2053C module provides the I/O pair-connection function. Before using this function, you need to prepare one CAN-2053C module and a 16-bit DO CAN-2000 series module (such as CAN-2057C). When applying this function, the DI channels of the CAN-2053C and the DO channels of the CAN-2057C are mapping with each other. That is to say that when the DI channels of the CAN-2053C get the ON signal, the corresponding DO channels of the CAN-2057C will be turned on.

When you completed the connection of the CAN-2053C and CAN2057C by CAN bus, you need to set the baud rate rotary switch of these two modules to 0x8 ~ 0xF, and configure the node ID of them by the special rule. Set the node ID to be odd for one module, and set the node ID of another module to be the value which is equal to the node ID increased one of the former. Therefore, they are the couple as the following figure.

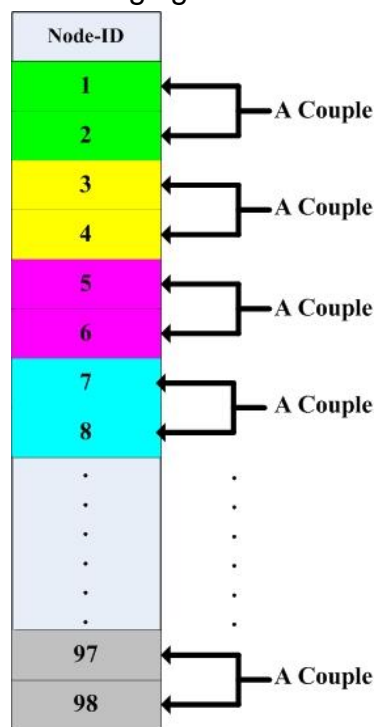

**Figure 2-4 I/O pair-connection group structure**

For example, user uses a CAN-2057C and a CAN-2053C to do I/O pair-connection. The connection structure is as follows.

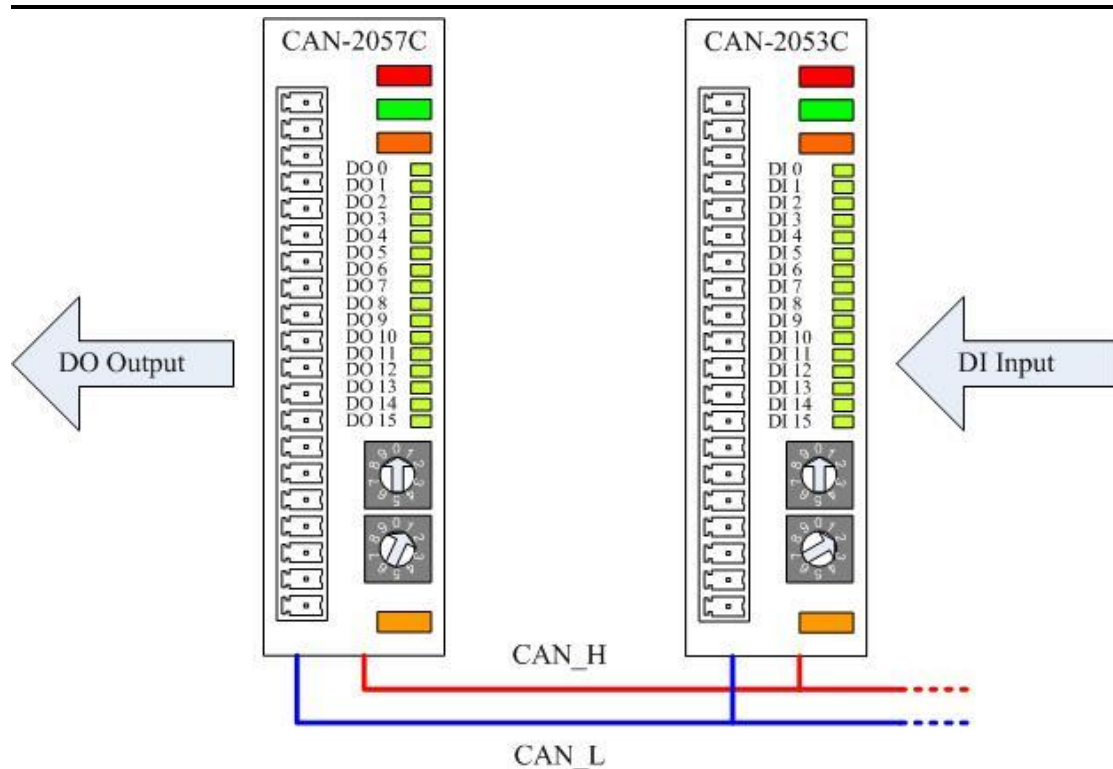

**Figure 2-5 I/O pair-connection wire connect**

The node ID of CAN-2057C is 1, and the node ID of CAN-2053C is 2. Both of these two module's baud rate switch are selected to "D", 500 kbps CANopen baud rate with I/O pair-connection mode, and these two modules will enter Operational state automatically. When the DI module, CAN-2053C, receives a DI ON-signal, the DO module, CAN-2057C, will output the ON-signal at the corresponding DO channels.

---

## 2.4 LED Description

### Power LED

CAN-2053C allows 10 VDC ~ 30 VDC for working voltage. The power consumption is 1.5 W. Under the connection of a proper power connection, as the unit is turned on, the LED will light up in red.

### Run LED

The Run LED indicates the CANopen operation state. The description of LED state is shown below. About the detail, please refer to the section 2.3.1 of the CAN-2000C user manual.

LED Signal	State	Description
No Light	Non-operation	Power Supply is not ready
Single Flash	Stopped	The device is in Stopped state
Blinking	Pre-operational	Device is in Pre-operational state
Continuing Light	Operational	Device is in Operational state

**Table 2-2 Run LED state description**

### Error LED

The Error LED indicates the CANopen error state. The description of LED state is shown below. About the detail please refer to the section 2.3.2 of the CAN-2000C user manual.

LED Signal	State	Description
No Light	No error	Device is working well.
Single Flash	Error Warning	At least one CANopen error happened.
Double Flash	Guarding Fail	Guarding fail event happened.
Continuing Light	Bus Off	The bus off state happened.

**Table 2-3 Err LED state description**

### Terminal Resistor LED

When enable the 120Ω terminator resistor, the LED will turn on.

### DI LED

If the DI LED turns on, it means that the corresponding DI channel receives an ON voltage-level digital signal no matter what the DI channel polarity is. (User can configure the 0x6002 object to change the polarity of the DI channel. More detail in section 3.3.)

---

## 2.5 PIN Assignment





















Terminal No.	Pin Assignment
 01	DI.COM
 02	DI.0
 03	DI.1
 04	DI.2
 05	DI.3
 06	DI.COM
 07	DI.4
 08	DI.5
 09	DI.6
 10	DI.7
 11	DI.COM
 12	DI.8
 13	DI.9
 14	DI.10
 15	DI.11
 16	DI.COM
 17	DI.12
 18	DI.13
 19	DI.14
 20	DI.15

Figure 2-6 CAN-2053C pin assignment

## 2.6 Wire Connection

Input Type	ON State LED ON Readback as 1	OFF State LED OFF Readback as 0
Relay Contact	Relay On	Relay Off
TTL/CMOS Logic	30 V > Voltage > 3.5 V	Voltage < 1 V
NPN Output	Open Collector On	Open Collector Off
PNP Output	Open Collector On	Open Collector Off

Figure 2-7 CAN-2053C Wire connection

## 3 Object Dictionary

### 3.1 Object List

#### General Communication Entries

Idx	Sidx	Description	Type	Attr	Default
1000h	0h	device type	UNSIGNED 32	RO	00010191h
1001h	0h	error register	UNSIGNED 8	RO	0h
1003h	0h	largest sub-index supported for "predefine error field"	UNSIGNED 8	RO	0h
	1h	actual error (the newest one)	UNSIGNED 32	RO	---
	...	...	...	...	---
	5h	actual error (the oldest one)	UNSIGNED 32	RO	---
1005h	0h	COB-ID of Sync message	UNSIGNED 32	RW	80h
1008h	0h	manufacturer device name	VISIBLE_STRING	RO	CAN-2053C
1009h	0h	manufacturer hardware version	VISIBLE_STRING	RO	1.3
100Ah	0h	manufacturer software version	VISIBLE_STRING	RO	1.20-20111227
100Ch	0h	guard time	UNSIGNED 16	RW	0h
100Dh	0h	life time factor	UNSIGNED 8	RW	0h
1010h	0h	largest sub-index supported for "store parameters"	UNSIGNED 8	RO	1h
1010h	1h	save all hardware parameter	UNSIGNED 32	RW	---
1011h	0h	largest sub-index supported for "restore default parameters"	UNSIGNED 8	RO	1h
1011h	1h	restore all default parameters	UNSIGNED 32	RW	---
1014h	0h	COB-ID of EMCY	UNSIGNED 32	RW	80h+x
1017h	0h	producer heartbeat time	UNSIGNED 16	RW	0
1018h	0h	largest sub-index supported for "identity object"	UNSIGNED 8	RO	4
	1h	vender ID	UNSIGNED 32	RO	---
	2h	product code	UNSIGNED 32	RO	---
	3h	revision number	UNSIGNED 32	RO	---
	4h	serial number	UNSIGNED 32	RO	---

**Table 3-1 General object dictionary**

**Note: x is Node-ID of the module**

### **SDO Communication Entries**

Idx	Sidx	Description	Type	Attr	Default
1200h	0h	largest sub-index supported for “server SDO parameter”	UNSIGNED 8	RO	2
	1h	COB-ID form client to server (RxSDO)	UNSIGNED 32	RO	600h+x
	2h	COB-ID form server to client (TxSDO)	UNSIGNED 32	RO	580h+x

**Table 3-2 SDO communication object dictionary**

**Note: x is Node-ID of the module**

### **RxPDO Communication Entry**

Idx	Sidx	Description	Type	Attr	Default
1400h	0h	Number of entries	UNSIGNED 8	RO	2
	1h	COB-ID used by RxPDO	UNSIGNED 32	RW	200h+x
	2h	Transmission type	UNSIGNED 8	RW	FFh
1401h	0h	Number of entries	UNSIGNED 8	RO	2
	1h	COB-ID used by RxPDO	UNSIGNED 32	RW	300h+x
	2h	Transmission type	UNSIGNED 8	RW	FFh
1402h	0h	Number of entries	UNSIGNED 8	RO	2
	1h	COB-ID used by RxPDO	UNSIGNED 32	RW	400h+x
	2h	Transmission type	UNSIGNED 8	RW	FFh
1403h	0h	Number of entries	UNSIGNED 8	RO	2
	1h	COB-ID used by RxPDO	UNSIGNED 32	RW	500h+x
	2h	Transmission type	UNSIGNED 8	RW	FFh
1404h	0h	Number of entries	UNSIGNED 8	RO	2
	1h	COB-ID used by RxPDO	UNSIGNED 32	RW	C000 0000h
	2h	Transmission type	UNSIGNED 8	RW	---
...	...	...	...	...	...
1409h	0h	Number of entries	UNSIGNED 8	RO	2
	1h	COB-ID used by RxPDO	UNSIGNED 32	RW	C000 0000h
	2h	Transmission type	UNSIGNED 8	RW	---

**Table 3-3 RxPDO communication object dictionary**

**Note: x is Node-ID of the module**

### **RxPDO Mapping Communication Entry**

Idx	Sidx	Description	Type	Attr	Default
1600h	0h	Number of entries	UNSIGNED 8	RW	0
...	...	...	...	...	...
1609h	0h	Number of entries	UNSIGNED 8	RW	0

**Table 3-4 RxPDO mapping object dictionary**

### **TxPDO Communication Entry**

Idx	Sidx	Description	Type	Attr	Default
1800h	0h	Number of entries	UNSIGNED 8	RO	5
	1h	COB-ID used by TxPDO	UNSIGNED 32	RW	180h+x
	2h	Transmission type	UNSIGNED 8	RW	FFh
	3h	Inhibit time	UNSIGNED 16		0
	4h	reversed	---	---	---
	5h	Event timer	UNSIGNED 16		0
1801h	0h	Number of entries	UNSIGNED 8	RO	5
	1h	COB-ID used by TxPDO	UNSIGNED 32	RW	280h+x
	2h	Transmission type	UNSIGNED 8	RW	FFh
	3h	Inhibit time	UNSIGNED 16		0
	4h	reversed	---	---	---
	5h	Event timer	UNSIGNED 16		0
1802h	0h	Number of entries	UNSIGNED 8	RO	5
	1h	COB-ID used by TxPDO	UNSIGNED 32	RW	380h+x
	2h	Transmission type	UNSIGNED 8	RW	FFh
	3h	Inhibit time	UNSIGNED 16		0
	4h	reversed	---	---	---
	5h	Event timer	UNSIGNED 16		0
1803h	0h	Number of entries	UNSIGNED 8	RO	5
	1h	COB-ID used by TxPDO	UNSIGNED 32	RW	480h+x
	2h	Transmission type	UNSIGNED 8	RW	FFh
	3h	Inhibit time	UNSIGNED 16		0
	4h	reversed	---	---	---
	5h	Event timer	UNSIGNED 16		0
1804h	0h	Number of entries	UNSIGNED 8	RO	5
	1h	COB-ID used by TxPDO	UNSIGNED 32	RW	8000 0000h
	2h	Transmission type	UNSIGNED 8	RW	---
	3h	Inhibit time	UNSIGNED 16		0



	4h	reversed	---	---	---
	5h	Event timer	UNSIGNED 16		0
...	...	...	...	...	...
1809h	0h	Number of entries	UNSIGNED 8	RO	5
	1h	COB-ID used by TxPDO	UNSIGNED 32	RW	8000 0000h
	2h	Transmission type	UNSIGNED 8	RW	---
	3h	Inhibit time	UNSIGNED 16		0
	4h	reversed	---	---	---
	5h	Event timer	UNSIGNED 16		0

**Table 3-5 TxPDO communication object dictionary**

**Note: x is Node-ID of the module**

**The unit of Inhibit time is 100us.**

**TxPDO Mapping Communication Entry**

Idx	Sidx	Description	Type	Attr	Default
1A00h	0h	Number of entries	UNSIGNED 8	RW	2
	1h	DI channel 0 ~ 7	UNSIGNED 32	RW	6000 0108h
	2h	DI channel 8 ~15	UNSIGNED 32	RW	6000 0208h
1601h	0h	Number of entries	UNSIGNED 8	RW	0
...	...	...	...	...	...
1A09h	0h	Number of entries	UNSIGNED 8	RW	0

**Table 3-6 RxPDO mapping object dictionary**

**Digital Input Function**

Idx	Sidx	Description	Type	Attr	Default
6000h	0h	Number of Input 8-Bit	UNSIGNED 8	RO	2
	1h	DI value of ch0 ~ ch7	UNSIGNED 8	RO	0
	2h	DI value of ch8 ~ ch15	UNSIGNED 8	RO	0
6002h	0h	Number of Input 8-Bit	UNSIGNED 8	RO	2
	1h	Change polarity DI ch0 ~ ch7	UNSIGNED 8	RW	0
	2h	Change polarity DI ch8 ~ ch15	UNSIGNED 8	RW	0
2030h	0h	Number of entries	UNSIGNED 8	RO	1
	1h	DI Scan Filter times	UNSIGNED 8	RW	2

**Table 3-7 Application object dictionary**

**Note: Object 0x2030h is used for DI noise. If there is any DI noise in your application, you can set the value larger to avoid the unexpected noise.**

---

## 3.2 Store and Restore Object

User can write the value 0x65766173 to the object index 0x1010 to save configuration setting, or write the value 0x64616F6C to object index 0x1011 to load the factory default. The following table lists the relative objects which will be stored or restored after writing these two objects. The factory default for these objects is also shown.

### Store and Restore functions:

Index	Subindex	Function
1010 h	1	Store application and communication setting.
1010 h	2	Store communication setting only.
1010 h	3	Store application setting only.
1011 h	1	Restore application and communication setting.
1011 h	2	Restore communication setting only.
1011 h	3	Restore application setting only.

**Table 3-8**

### Communication Setting:

Please refer to above table 3-3, 3-4, 3-5, and 3-6.

### Application Setting:

Index	Sub Index	Description	Factory Default
2100 h	1	Set Module to Operation Mode when powering on	0x00
6002 h	1	Change polarity digital input for channel 0 ~ 7	0x00
6002 h	2	Change polarity digital input for channel 8 ~ 15	0x00

**Table 3-9 Store and Restore the object list**

### 3.3 Application Object

#### Digital Input module (0x6000)

User can use the object index 0x6000 with subindex 1 to read the DI-channel information. For example, if the node ID of CAN-2053C is 1, the commands are as below:

11-bit COB-ID (bit)											RTR	Data Length	8-byte Data (byte)							
Func Code				Node ID									0	1	2	3	4	5	6	7
10	9	8	7	6	5	4	3	2	1	0										
1	1	0	0	0	0	0	0	0	0	1	0	8	40	00	60	01	00	00	00	

**SDO client**



**SDO server  
(CAN-2053C)**

11-bit COB-ID (bit)											RTR	Data Length	8-byte Data (byte)							
Func Code				Node ID									0	1	2	3	4	5	6	7
10	9	8	7	6	5	4	3	2	1	0										
1	0	1	1	0	0	0	0	0	0	1	0	4	4F	00	60	01	37	--	--	--

**SDO client**



**SDO server  
(CAN-2053C)**

Read the object index 0x6000 with subindex 1 by using SDO. The value 0x37 indicated first 8-channel DI status will be responded by CAN-2053C module. The DI channels of DI5, DI4, DI2, DI1 and DI0 turn on and others are turn off.

#### Change Input Polarity (0x6002)

User can configure the object index 0x6002 with subindex 1 to set the polarity of DI channels.

This object 0x6002 with subindex 1 defines the polarity of a group of 8 input lines. Input polarity can be inverted individually.

1 = input inverted.

0 = input not inverted.

For example, if the node ID of CAN-2053C is 1, the commands are as below:

11-bit COB-ID (bit)											RTR	Data Length	8-byte Data (byte)							
Func Code				Node ID									0	1	2	3	4	5	6	7
10	9	8	7	6	5	4	3	2	1	0										
1	1	0	0	0	0	0	0	0	0	1	0	8	2F	02	60	01	F0	03	00	00

**SDO client**



**SDO server  
(CAN-2053C)**

11-bit COB-ID (bit)											RTR	Data Length	8-byte Data (byte)							
Func Code				Node ID									0	1	2	3	4	5	6	7
10	9	8	7	6	5	4	3	2	1	0										
1	0	1	1	0	0	0	0	0	0	1	0	4	60	02	60	01	--	--	--	--

**SDO client**



**SDO server  
(CAN-2053C)**

Write object index 0x6002 with subindex 1 to 0xF0 means that set the Ch0 ~ Ch3 of DI channels to normal, and set the Ch4 ~ Ch7 to be inverted.

---

## Set Module to Operation Mode when powering on (0x2100)

This object 0x2100 with subindex 1 defines if the module will enter operation mode automatically when powering on.

For example, if the node id of CAN-2053C is 1, the commands are as below:

11-bit COB-ID (bit)											RTR	Data Length	8-byte Data (byte)							
Func Code				Node ID									0	1	2	3	4	5	6	7
10	9	8	7	6	5	4	3	2	1	0			0	1	2	3	4	5	6	7
1	1	0	0	0	0	0	0	0	0	1	0	8	2F	00	21	01	01	00	00	00

**SDO client**



**SDO server  
(CAN-2053C)**

11-bit COB-ID (bit)											RTR	Data Length	8-byte Data (byte)							
Func Code				Node ID									0	1	2	3	4	5	6	7
10	9	8	7	6	5	4	3	2	1	0			0	1	2	3	4	5	6	7
1	1	0	0	0	0	0	0	0	0	1	0	8	60	00	21	01	--	--	--	--

**SDO client**



**SDO server  
(CAN-2053C)**

Write object index 0x2100 with subindex 1 to 0x01 then store the setting as below. Module will enter operation mode when powering on.

11-bit COB-ID (bit)											RTR	Data Length	8-byte Data (byte)							
Func Code				Node ID									0	1	2	3	4	5	6	7
10	9	8	7	6	5	4	3	2	1	0										
1	1	0	0	0	0	0	0	0	0	1	0	8	23	10	10	01	73	61	76	65

**SDO client**



**SDO server  
(CAN-2053C)**

11-bit COB-ID (bit)											RTR	Data Length	8-byte Data (byte)							
Func Code				Node ID									0	1	2	3	4	5	6	7
10	9	8	7	6	5	4	3	2	1	0										
1	1	0	0	0	0	0	0	0	0	1	0	8	60	10	10	01	--	--	--	--

**SDO client**

**SDO server  
(CAN-2053C)**

### 3.4 Default PDO Mapping

TxPDO mapping list:

ID	Len	D 0	D 1
180h + x	2	DI 0 ~ DI 7	DI 8 ~ DI 15

**Table 3-10 Default TxPDO list**

**Note: x is Node-ID of the module**