

Twin Timer with Free Power, Compact Size W38×H42mm

■ Features

- Wide power supply range
: 100-240VAC 50/60Hz, 24-240VDC universal, 24VAC 50/60Hz, 24VDC universal, 12VDC
- Various output operations (6 operation modes)
- Multi time range (12 types of time range)
- Twin timer to set ON/OFF time individually
- Close and DIN rail mounting with the dedicated socket (PS-M8) width 41mm (for ATS8W)
- Easy installation/maintenance with the dedicated bracket for DIN 48×48mm



⚠ Please read "Safety Considerations" in the instruction manual before using.



■ Ordering Information

ATS	8	W	4	1			
					Time range		
					1	Time range 1 (0.1 to 1)	
					3	Time range 3 (0.3 to 3)	
					Power supply		
					1	12VDC	
					2	24VAC 50/60Hz, 24VDC	
					4	100-240VAC 50/60Hz, 24-240VDC	
					Time operation		
					W	Twin (flicker) operation	
					Number of plug pins		
					8	8-pin plug type	
					11	11-pin plug type	
					Item	ATS	Compact Analog Timer

※8-pin socket (PG-08, PS-08(N), PS-08) and 11-pin socket (PG-11, PS-11(N)) are sold separately.

■ Specifications

Model	ATS8W-□1	ATS11W-□1	ATS8W-□3	ATS11W-□3
Function	ON/OFF Flicker operation			
Control time setting range ^{※1}	0.1 sec to 10 hour		0.3 sec to 30 hour	
Power supply	•100-240VAC~ 50/60Hz, 24-240VDC≡ universal		•24VAC~ 50/60Hz, 24VDC≡ universal	•12VDC≡
Allowable voltage range	90 to 110% of rated voltage			
Power consumption	•Max. 4.2VA (100-240VAC~), Max. 2W (24-240VDC≡)		•Max. 4.5VA (24VAC~), Max. 2W (24VDC≡)	
Return time	Max. 100ms			
Timing operation	Power ON Start			
Control output	Contact type	Time limit DPDT (2c) or Instantaneous SPDT (1c)+Time limit SPDT (1c) selectable by output operation mode		
	Contact capacity	250VAC~ 3A, 30VDC≡ 3A resistive load		
Relay life cycle	Mechanical	Min. 10,000,000 operations		
	Electrical	Min. 100,000 operations (250VAC 3A resistive load)		
Repeat error	Max. ±0.2% ±10ms			
SET error	Max. ±5% ±50ms			
Voltage error	Max. ±0.5%			
Temperature error	Max. ±2%			
Insulation resistance	Over 100MΩ (at 500VDC megger)			
Dielectric strength	2,000VAC 50/60Hz for 1 min			
Noise immunity	ATS□W-1□ ATS□W-2□	±500V the square wave noise (pulse width 1μs) by noise simulator		
	ATS□W-4□	±2kV the square wave noise (pulse width 1μs) by noise simulator		
Vibration	Mechanical	0.75mm amplitude at frequency of 10 to 55Hz (for 1min) in each X, Y, Z direction for 1 hour		
	Malfunction	0.5mm amplitude at frequency of 10 to 55Hz (for 1min) in each X, Y, Z direction for 10 min		
Shock	Mechanical	300m/s ² (approx. 30G) in each X, Y, Z direction 3 times		
	Malfunction	100m/s ² (approx. 10G) in each X, Y, Z direction 3 times		
Environment	Ambient temp.	-10 to 55°C, storage: -25 to 65°C		
	Ambient humi.	35 to 85%RH, storage: 35 to 85%RH		
Approval	CE c UL US			
Accessory	Bracket			
Weight ^{※2}	Approx. 100g (approx. 75g)			

※1: Refer to time specifications for control time setting range by model.

※2: The weight includes packaging. The weight in parenthesis is for unit only. ※Environment resistance is rated at no freezing or condensation.

SENSORS

CONTROLLERS

MOTION DEVICES

SOFTWARE

(J) Temperature Controllers

(K) SSRs

(L) Power Controllers

(M) Counters

(N) Timers

(O) Digital Panel Meters

(P) Indicators

(Q) Converters

(R) Digital Display Units

(S) Sensor Controllers

(T) Switching Mode Power Supplies

(U) Recorders

(V) HMIs

(W) Panel PC

(X) Field Network Devices

ATS8W/ATS11W Series

Connections

ATS8W

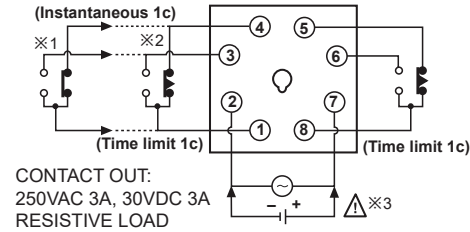

※1: When selecting [F2], [N2] output operation mode.
※2: When selecting [F1], [F3], [N1], [N3] output operation mode.

ATS11W

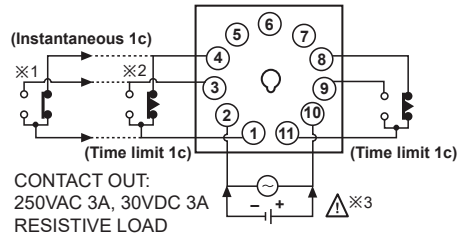

※3: AC/DC voltage: 100-240VAC 50/60Hz, 24-240VDC
24VAC 50/60Hz, 24VDC
DC voltage: 12VDC

Dimensions

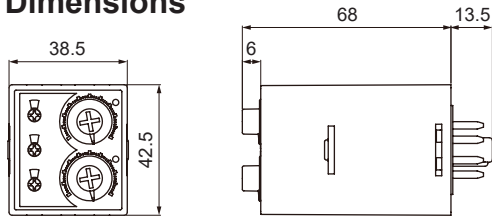

(unit: mm)

Bracket

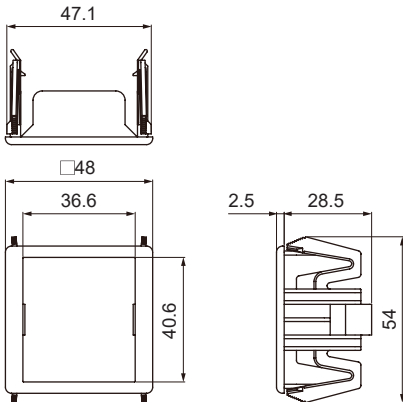

Panel cut-out

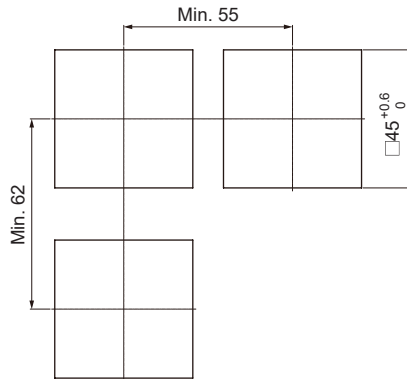

Unit Description

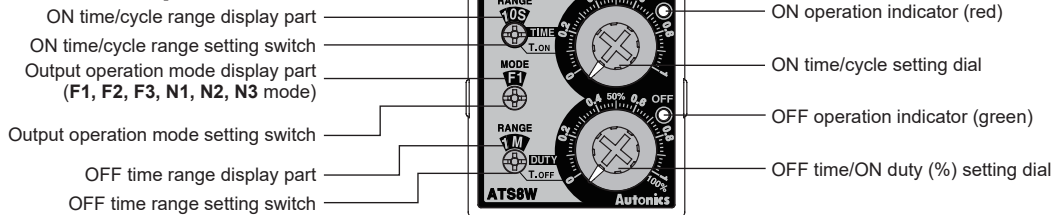

Time Specifications

Model	Time range	Time unit	Time setting range	Model	Time range	Time unit	Time setting range
ATS□W-□1	1S	SEC	0.1 to 1 sec	ATS□W-□3	1S	SEC	0.3 to 3 sec
	10S		1 to 10 sec		10S		3 to 30 sec
	1M	MIN	0.1 to 1 min		1M	MIN	0.3 to 3 min
	10M		1 to 10 min		10M		3 to 30 min
	1H	HOUR	0.1 to 1 hour		1H	HOUR	0.3 to 3 hour
	10H		1 to 10 hour		10H		3 to 30 hour

Compact Twin Analog Timer

Output Operation Mode

[T_{ON}: ON Setting time, T_{OFF}: OFF Setting time, TIME: Cycle, DUTY: ON Time duty rate, Rt: Return time, Rt>Rt]

Mode	Time chart
F1 OFF Start Flicker1	
F2 OFF Start Flicker2	
F3 OFF Start Flicker3	
N1 ON Start Flicker1	
N2 ON Start Flicker2	
N3 ON Start Flicker3	

※Setting time should be over 100ms. If not, it may cause abnormal output operation due to under 100ms of setting time.
 ※[F3], [N3] mode operates flicker by setting cycle (time) and ON duty (%). ON time range changes to cycle (time) range and OFF time range changes to ON duty (%).

- SENSORS
- CONTROLLERS
- MOTION DEVICES
- SOFTWARE
- (J) Temperature Controllers
- (K) SSRs
- (L) Power Controllers
- (M) Counters
- (N) Timers
- (O) Digital Panel Meters
- (P) Indicators
- (Q) Converters
- (R) Digital Display Units
- (S) Sensor Controllers
- (T) Switching Mode Power Supplies
- (U) Recorders
- (V) HMIs
- (W) Panel PC
- (X) Field Network Devices

ATS8W/ATS11W Series

■ Proper Usage

- Follow instructions in 'Proper Usage'. Otherwise, it may cause unexpected accidents.
- 12VDC, 24VDC, 24VAC power supply should be insulated and limited voltage/current or Class 2, SELV power supply device.
- When supplying or turning off the power, use a switch or etc. to avoid chattering.
- Install a power switch or circuit breaker in the easily accessible place for supplying or disconnecting the power.
- In order to block peripheral current, use isolation transformer which of secondary part is not grounded as (Figure 1) to supply power to the external input device.

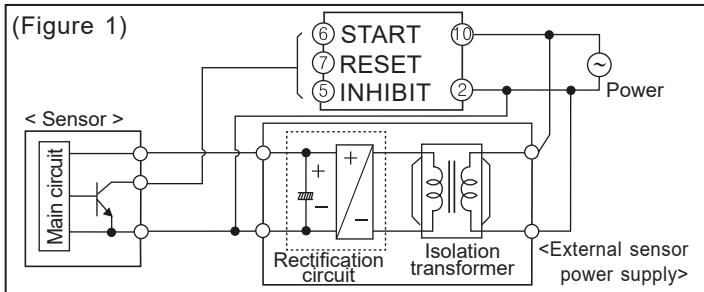

- In order to avoid leakage current flowing, connect resistance and condenser as (Figure 2). If connect as (Figure 1), it may cause malfunction due to leakage current.

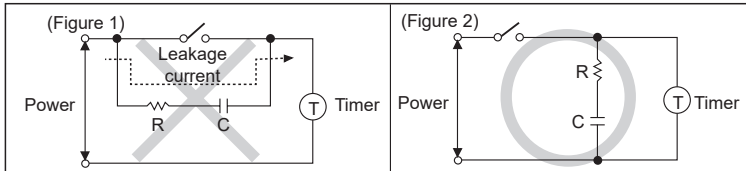

- Do not connect two or more timers with only one input contact or transistor simultaneously.
- Keep away from high voltage lines or power lines to prevent inductive noise.
In case installing power line and input signal line closely, use line filter or varistor at power line and shielded wire at input signal line.
- Do not use near the equipment which generates strong magnetic force or high frequency noise.
- Change setting time, time range, operation mode or etc. after turning off the power of the timer.
- This unit may be used in the following environments.
 - ① Indoors (in the environment condition rated in 'Specifications')
 - ② Altitude max. 2,000m
 - ③ Pollution degree 2
 - ④ Installation category II