

Description

The AM4962 is a full wave driver IC with direct PWM control function. It is used for single-phase motor and is capable of speed control by PWM pulse.

The AM4962 is available in HTSSOP-14 and SSOP-16 packages.

Features

- The Motor Speed is Controlled by PWM Pulse Directly
- Built-in Triangle Wave Circuit Without Extra Oscillation Capacitor
- Built-in Hall Bias Circuit
- Built-in Minimal Speed Setup Circuit
- Slope K* Adjustable
- Rotation Speed Indication (FG)
- Rotation or Lock State Indication (RD)
- Built-in Thermal Shutdown Circuit
- Lock Protection and Auto-Restart
- Output Current Limit

* Slope K is the slope of output PWM duty vs. input PWM duty

Applications

- CPU Cooler Fan in PC
- Brushless DC Motor Driver

Pin Assignments

(Top View)

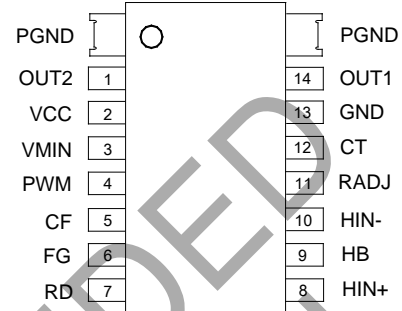

HTSSOP-14

(Top View)

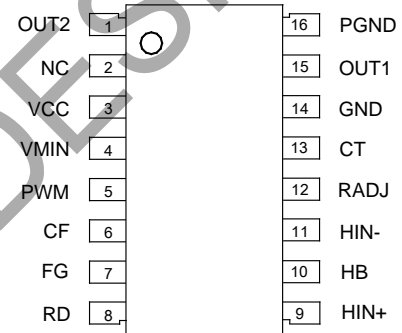

SSOP-16

NOT RECOMMENDED FOR NEW DESIGN

Typical Applications Circuit (Note 1)

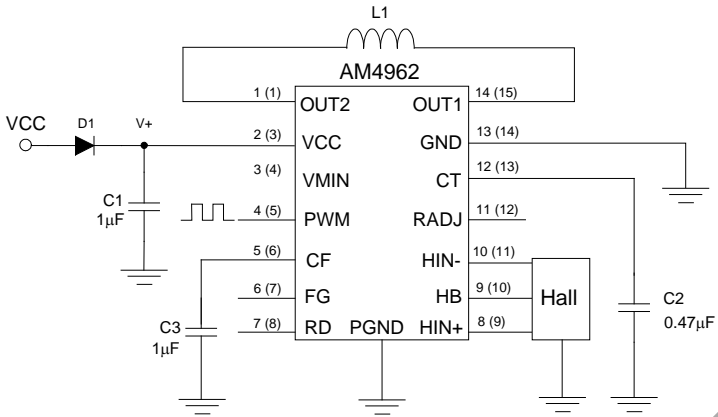

Application 1 (Default)

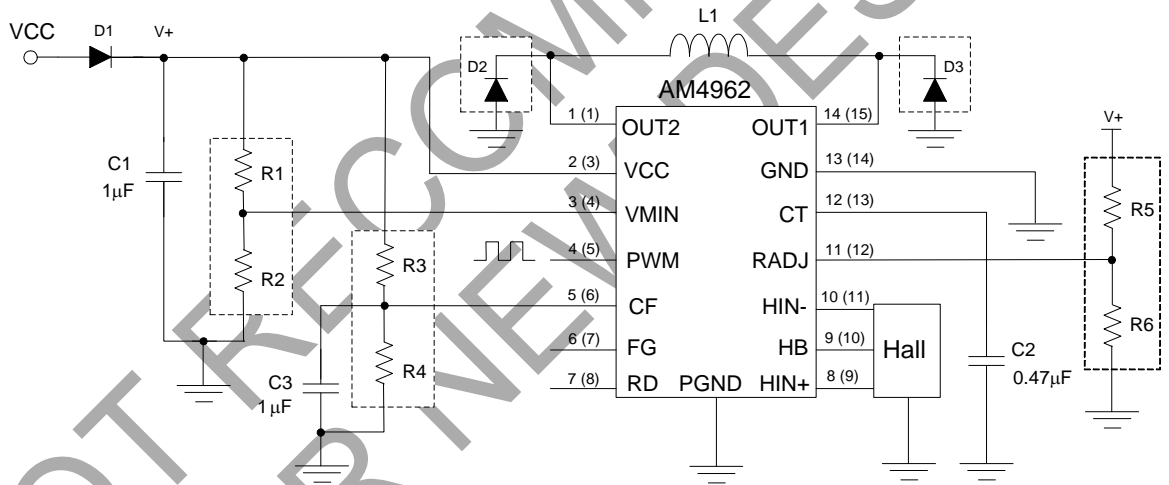
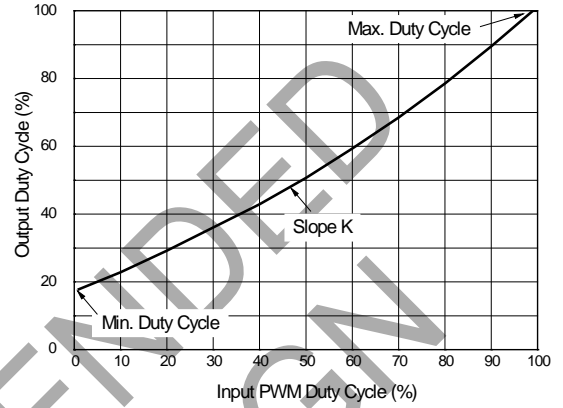

Application 2 (Slope K and Minimum/Maximum Duty Adjustable)

Note: D2 and D3 are recommended to be used when the current in coil L1 is higher than 300mA.

Typical Applications Circuit (Note 1) (Continued)

Note 1 (Refer to application circuit 2 unless otherwise noted.):

Adjust slope K of output PWM's duty vs. input PWM's duty

1. The default K is about 0.8
2. Adding R5 can increase K
3. Adding R6 can decrease K

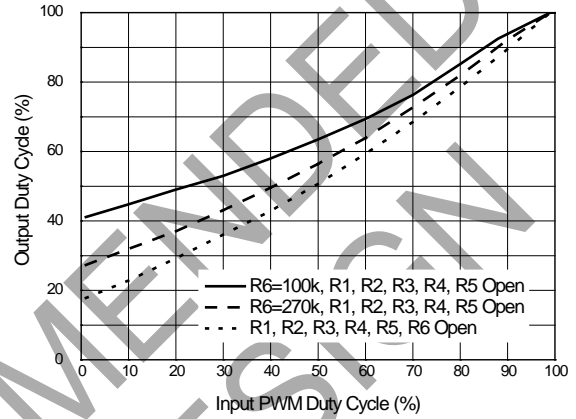
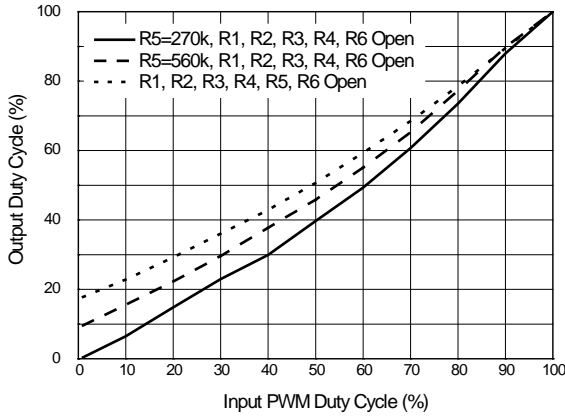

Adjust minimum duty of output PWM:

1. The default minimum duty of output PWM is about 20%
2. Decreasing R2 can increase minimum output PWM duty
3. Adding R5 can decrease minimum output PWM duty

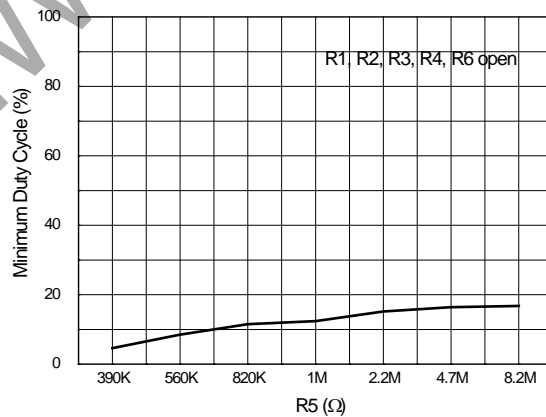
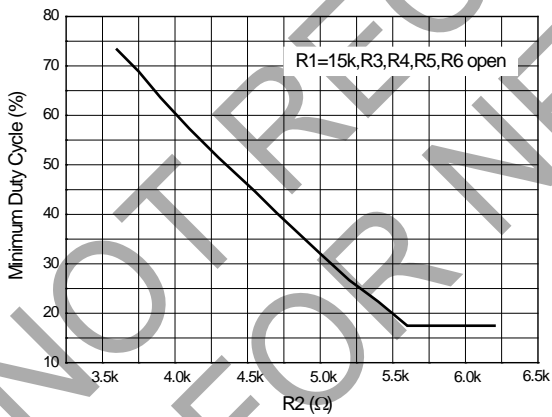

Typical Applications Circuit (Note 1) (Continued)

Adjust maximum duty of output PWM:

1. The default maximum output PWM duty is 100%.
2. Adding R3 can decrease maximum output PWM duty.
3. Adding R4 can increase maximum output PWM duty.

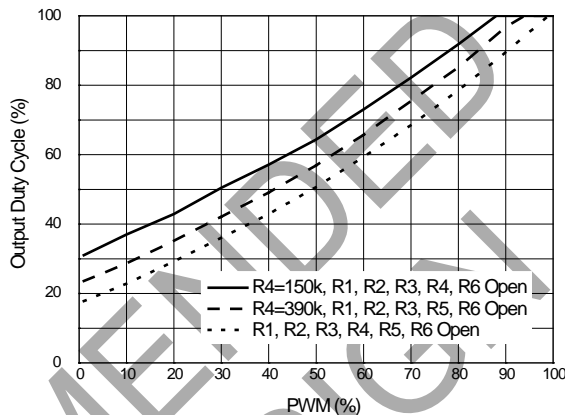
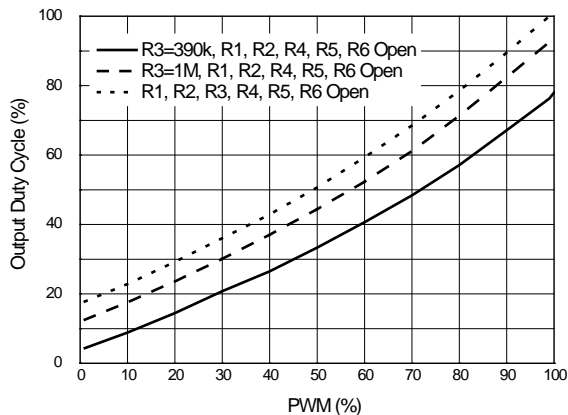

Pin Descriptions

Pin Number		Pin Name	Function
HTSSOP-14	SSOP-16		
1	1	OUT2	Driver output 2
—	2	NC	No connection
2	3	VCC	Power supply
3	4	VMIN	Minimum duty setting
4	5	PWM	PWM pulse Input
5	6	CF	PWM filter capacitor
6	7	FG	Rotation speed indicator
7	8	RD	Rotation/lock state indicator
8	9	HIN+	Hall sensor input +
9	10	HB	Hall sensor bias regulator
10	11	HIN-	Hall sensor input -
11	12	RADJ	Slope K adjustable terminal
12	13	CT	Lock and rotation setting capacitor terminal
13	14	GND	Ground for control circuit
14	15	OUT1	Driver output 1
—	16	PGND	Power ground

Functional Block Diagram

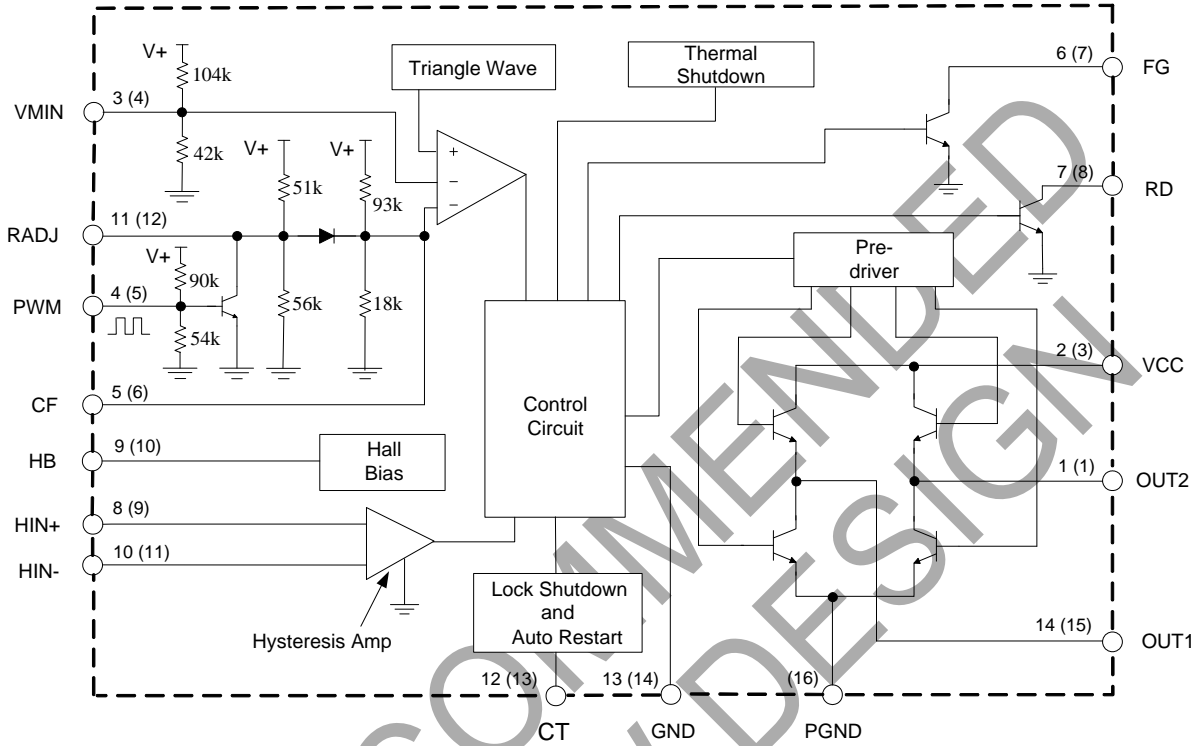

A (B)
A HTSSOP-14
B SSOP-16

Truth Table (Note 2)

Items	IN-	IN+	CF	CT	OUT1	OUT2	FG	Mode
1	H	L	L	L	H	L	L	Rotation
2	L	H			L	H	Off	PWM off
3	H	L	H		L	Off	L	Rotation Recirculate
4	L	H				L	Off	Off
5	H	L	L	H	H	Off	L	Lock Protection
6	L	H			Off	H	Off	

Note 2: $V_{CF(H)}=5V$, $V_{CF(L)}=1V$, $V_{CT(H)}=5V$, $V_{CT(L)}=0$

Absolute Maximum Ratings (Note 3)

Symbol	Parameter	Value		Unit
V _{CC}	Supply Voltage	18		V
I _{OUT}	Output Current	1.0		A
V _{OUT}	Output Voltage	18		V
I _{HB}	HB Output Current	10		mA
V _{RD}	RD Output Voltage	18		V
V _{FG}	FG Output Voltage	18		V
I _{RD}	RD Output Current	10		mA
I _{FG}	FG Output Current	10		mA
P _D	Power Dissipation	SSOP-16	0.8	W
		HTSSOP-14	1.1	W
T _{STG}	Storage Temperature Range	-55 to +150		°C
θ _{JA}	Thermal Resistance (Junction to Ambient)	SSOP-16	156	°C/W
		HTSSOP-14	114	
ESD	ESD (Human Body Model)	2000		V
ESD	ESD (Machine Model)	250		V

Note 3: Stresses greater than those listed under "Absolute Maximum Ratings" may cause permanent damage to the device. These are stress ratings only, and functional operation of the device at these or any other conditions beyond those indicated under "Recommended Operating Conditions" is not implied. Exposure to "Absolute Maximum Ratings" for extended periods may affect device reliability.

Recommended Operating Conditions

Symbol	Parameter	Min	Typ	Max	Unit
V _{CC}	Supply Voltage	3.5	12	16	V
V _{IN+}	Hall Input Voltage + (Note 4)	0.2	—	3	V
V _{IN-}	Hall Input Voltage - (Note 4)	0.2	—	3	V
V _{PWM}	PWM High Level Voltage	—	—	V _{CC} -1	V
T _A	Ambient Temperature	-30	—	+90	°C

Note 4: Hall input voltage range includes the amplitude of signal.

Electrical Characteristics ($V_{CC}=12V$, $T_A=+25^{\circ}C$, unless otherwise specified.)

Symbol	Parameter	Conditions	Min	Typ	Max	Unit
I_{Q1}	Quiescent Current	$V_{CT}=0$	10.18	15	18.76	mA
I_{Q2}		$V_{CT}=5V$	5.38	8	10.55	
V_{SATH}	Output Saturation Voltage at High Side	$I_{SOURCE}=200mA$	—	1.0	1.17	V
V_{SATL}	Output Saturation Voltage at Low Side	$I_{SINK}=200mA$	—	0.2	0.3	V
f_{OSC}	CPWM Frequency	—	18	25	32	kHz
V_{CFH}	CF High Level Voltage	$V_{PWM}=0$	3.2	3.6	3.75	V
V_{CFL}	CF Low Level Voltage	$V_{PWM}=5$	1.83	1.95	2.15	V
V_{MIN}	VMIN Voltage	—	3.4	3.7	4.0	V
V_{ADJ}	RADJ Pin Voltage	$V_{PWM}=0$	3.6	3.8	4.4	V
V_{HYS}	Hall Input Hysteresis	—	—	± 10	± 20	mV
V_{HB}	Hall Bias Voltage	$I_{HB}=5mA$	1.1	1.25	1.4	V
V_{CTH}	CT High Level Voltage	—	3.55	3.7	3.88	V
V_{CTL}	CT Low Level Voltage	—	1.55	1.7	1.85	V
I_{CHG}	CT Charge Current	—	1.5	2	2.85	μA
I_{DHG}	CT Discharge Current	—	0.14	0.2	0.285	μA
R_{CD}	CT Charge and Discharge Ratio	I_{CHG}/I_{DHG}	8.5	10	14.5	—
V_{FGL}	FG Output Low Level Voltage	$I_{FG}=5mA$	—	0.2	0.3	V
I_{LFG}	FG Leakage Current	$V_{FG}=12V$	—	—	30	μA
$V_{RD L}$	RD Output Low Level Voltage	$I_{RD}=5mA$	—	0.2	0.3	V
I_{LRD}	RD Leakage Current	$V_{RD}=12V$	—	—	30	μA

Performance Characteristics

Quiescent Current vs. Ambient Temperature

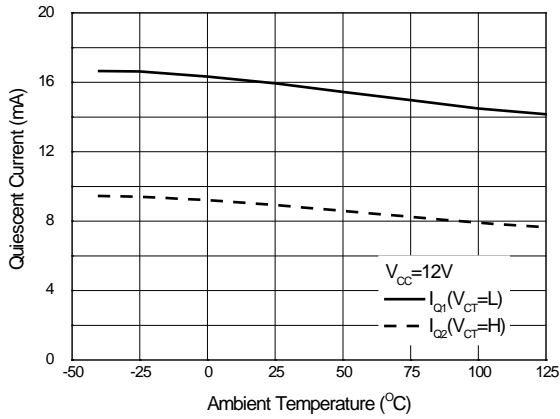

Quiescent Current vs. Supply Voltage

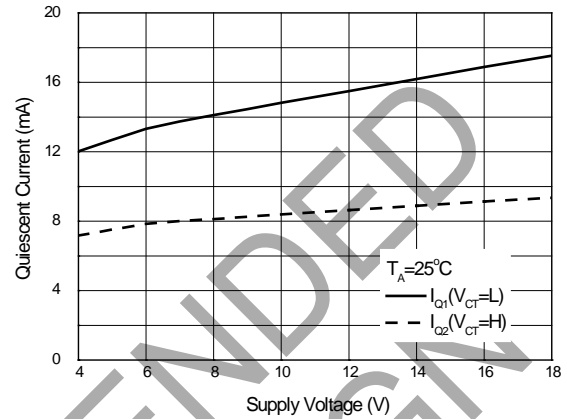

Output Saturation Voltage vs. Output Current

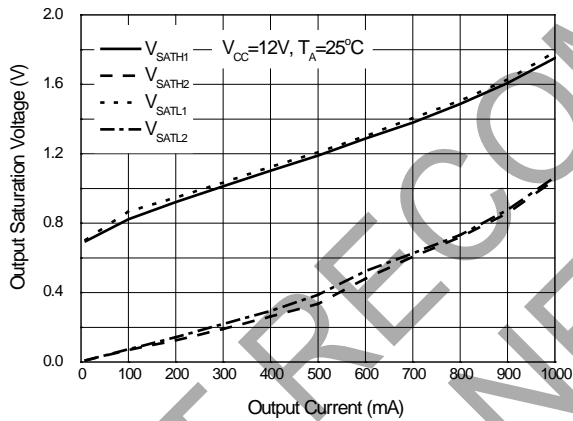

Power Dissipation vs. Ambient Temperature

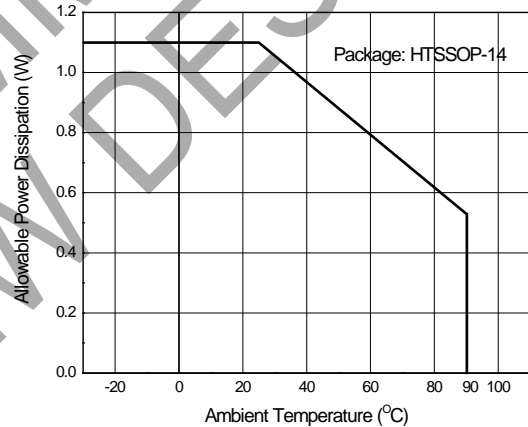

Power Dissipation vs. Ambient Temperature

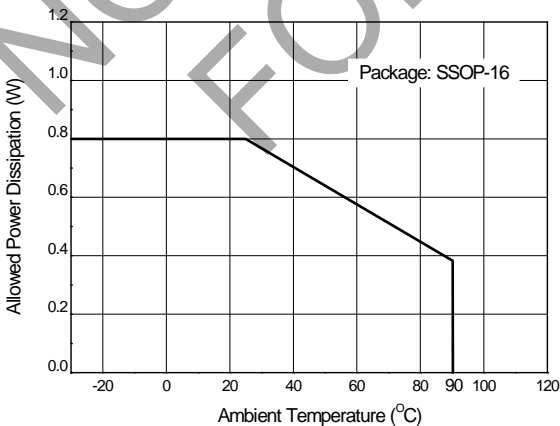

Operating Diagram

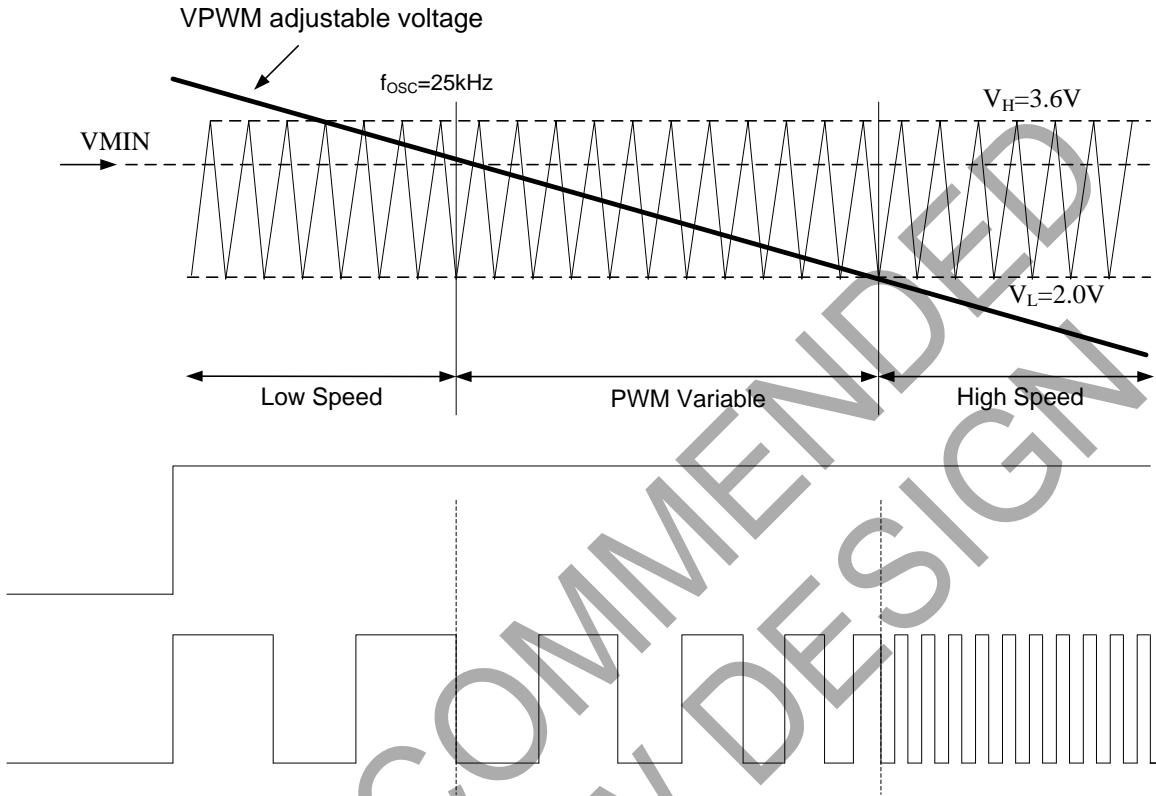

All parameters are tested under $V_{CC} = 12\text{V}$

NOT RECOMMENDED FOR NEW DESIGN

Ordering Information

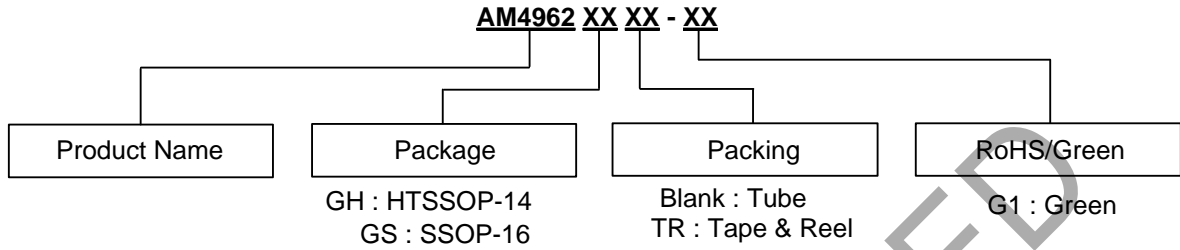

Package	Temperature Range	Part Number	Marking ID	Packing
HTSSOP-14	-30 to +90°C	AM4962GH-G1	AM4962GH-G1	Tube
		AM4962GHTR-G1	AM4962GH-G1	Tape & Reel
SSOP-16		AM4962GS-G1	AM4962GS-G1	Tube
		AM4962GSTR-G1	AM4962GS-G1	Tape & Reel

NOT RECOMMENDED FOR NEW DESIGN

Package Outline Dimensions (All dimensions in mm(inch))

Please see <http://www.diodes.com/package-outlines.html> for the latest version.

(1) Package Type: HTSSOP-14

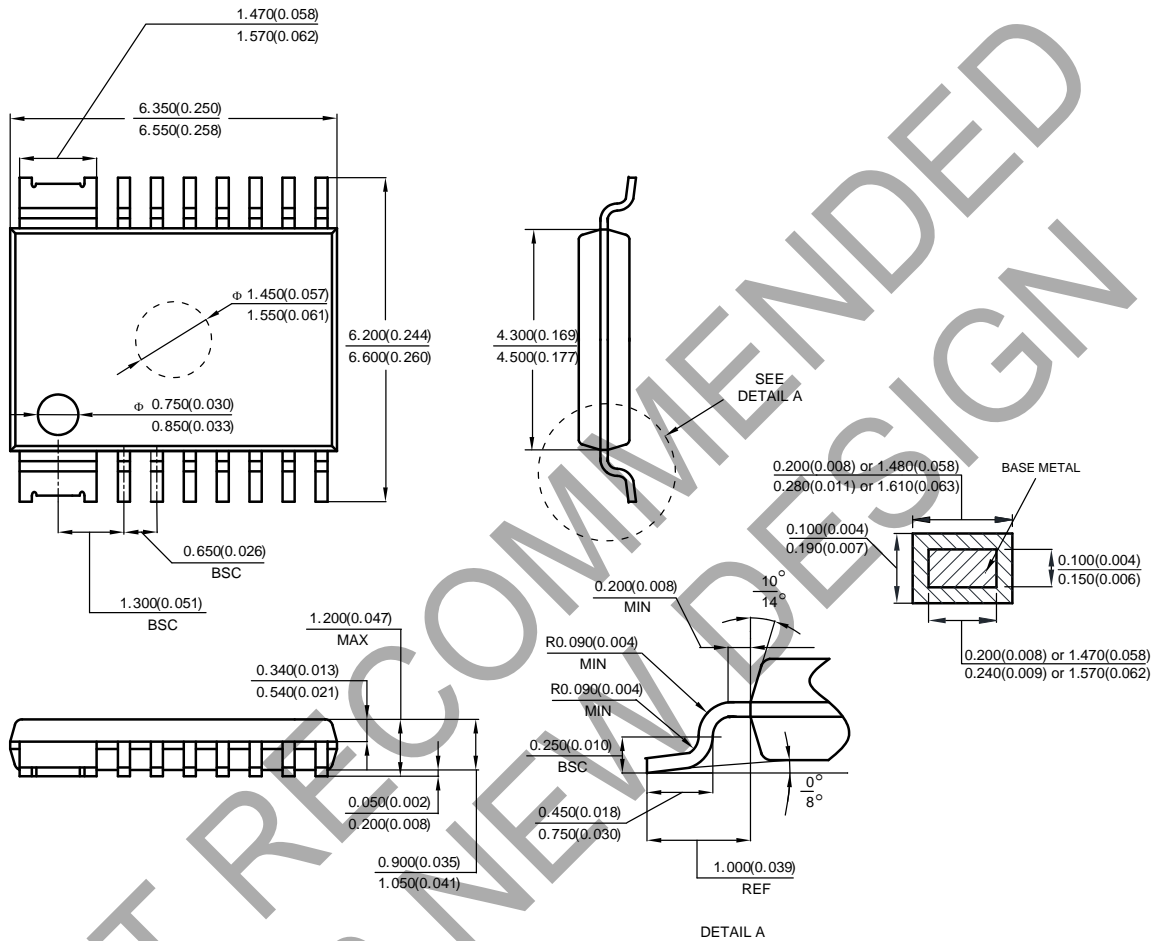

Note: Eject hole, oriented hole and mold mark is optional.

Package Outline Dimensions (All dimensions in mm(inch)) (Continued)

Please see <http://www.diodes.com/package-outlines.html> for the latest version.

(2) Package Type: SSOP-16

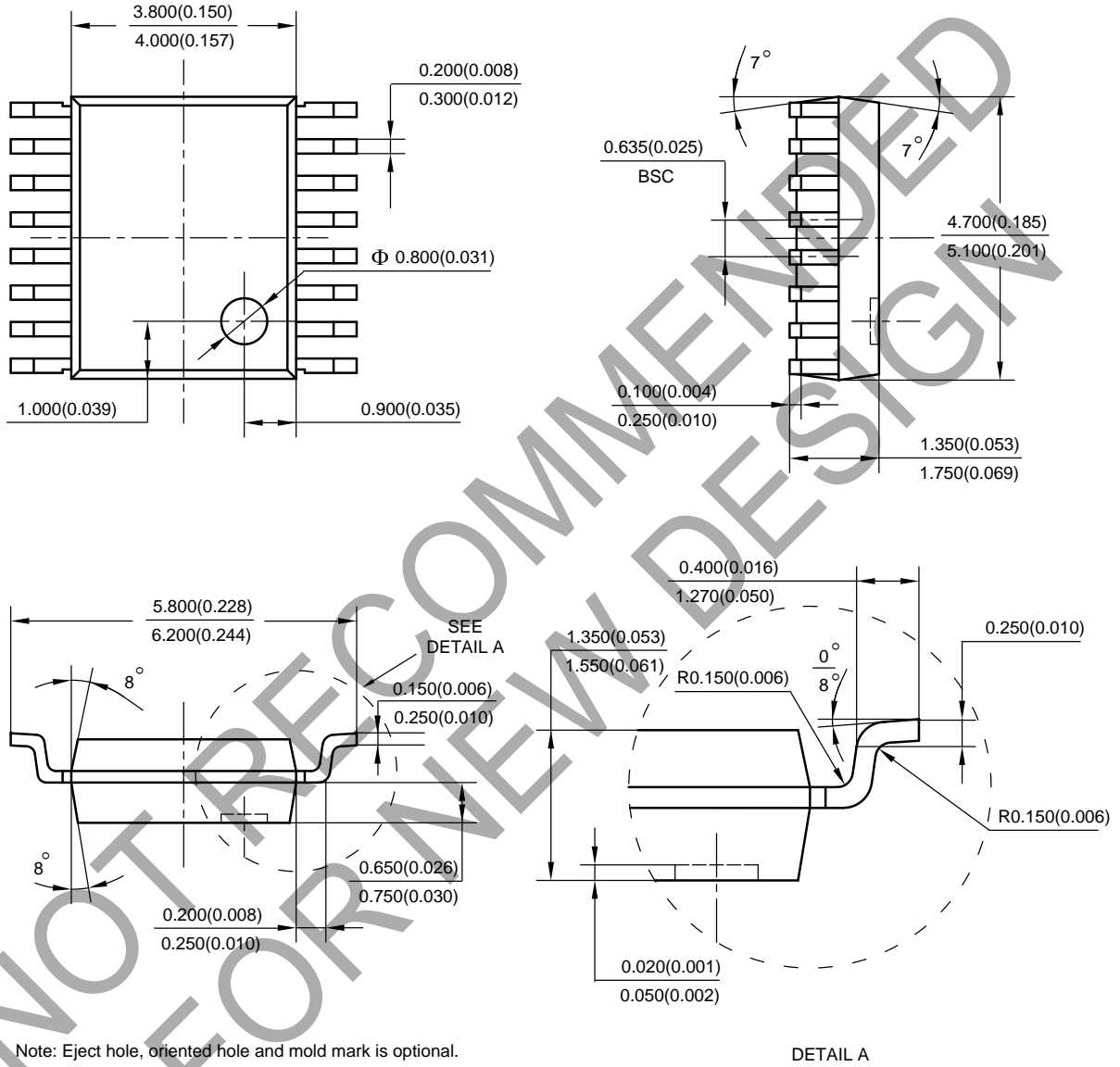

IMPORTANT NOTICE

DIODES INCORPORATED MAKES NO WARRANTY OF ANY KIND, EXPRESS OR IMPLIED, WITH REGARDS TO THIS DOCUMENT, INCLUDING, BUT NOT LIMITED TO, THE IMPLIED WARRANTIES OF MERCHANTABILITY AND FITNESS FOR A PARTICULAR PURPOSE (AND THEIR EQUIVALENTS UNDER THE LAWS OF ANY JURISDICTION).

Diodes Incorporated and its subsidiaries reserve the right to make modifications, enhancements, improvements, corrections or other changes without further notice to this document and any product described herein. Diodes Incorporated does not assume any liability arising out of the application or use of this document or any product described herein; neither does Diodes Incorporated convey any license under its patent or trademark rights, nor the rights of others. Any Customer or user of this document or products described herein in such applications shall assume all risks of such use and will agree to hold Diodes Incorporated and all the companies whose products are represented on Diodes Incorporated website, harmless against all damages.

Diodes Incorporated does not warrant or accept any liability whatsoever in respect of any products purchased through unauthorized sales channel. Should Customers purchase or use Diodes Incorporated products for any unintended or unauthorized application, Customers shall indemnify and hold Diodes Incorporated and its representatives harmless against all claims, damages, expenses, and attorney fees arising out of, directly or indirectly, any claim of personal injury or death associated with such unintended or unauthorized application.

Products described herein may be covered by one or more United States, international or foreign patents pending. Product names and markings noted herein may also be covered by one or more United States, international or foreign trademarks.

This document is written in English but may be translated into multiple languages for reference. Only the English version of this document is the final and determinative format released by Diodes Incorporated.

LIFE SUPPORT

Diodes Incorporated products are specifically not authorized for use as critical components in life support devices or systems without the express written approval of the Chief Executive Officer of Diodes Incorporated. As used herein:

A. Life support devices or systems are devices or systems which:

1. are intended to implant into the body, or
2. support or sustain life and whose failure to perform when properly used in accordance with instructions for use provided in the labeling can be reasonably expected to result in significant injury to the user.

B. A critical component is any component in a life support device or system whose failure to perform can be reasonably expected to cause the failure of the life support device or to affect its safety or effectiveness.

Customers represent that they have all necessary expertise in the safety and regulatory ramifications of their life support devices or systems, and acknowledge and agree that they are solely responsible for all legal, regulatory and safety-related requirements concerning their products and any use of Diodes Incorporated products in such safety-critical, life support devices or systems, notwithstanding any devices- or systems-related information or support that may be provided by Diodes Incorporated. Further, Customers must fully indemnify Diodes Incorporated and its representatives against any damages arising out of the use of Diodes Incorporated products in such safety-critical, life support devices or systems.

Copyright © 2020, Diodes Incorporated

www.diodes.com