



SURFACE MOUNT

Bi-Directional Coupler

ADCB-20-82+

Mini-Circuits

50Ω 20dB Coupling 1 to 800 MHz

THE BIG DEAL

- Very Flat Coupling, 0.2 dB
- Very Low Loss, 0.3 dB
- Small Size
- Aqueous washable
- Protected by US Patents, 6,133,525 & 6,140,887



Generic photo used for illustration purposes only

CASE STYLE: CD636

+RoHS Compliant

The +Suffix identifies RoHS Compliance. See our web site for RoHS Compliance methodologies and qualifications

APPLICATIONS

- Cable TV
- Communications

PRODUCT OVERVIEW

ADCB-20-82+ is a surface mount, bi-directional coupler, operating over a wide frequency range, 1-800 MHz housed in a small case measuring 0.31" x 0.27" x 0.16" (7.9 mm x 6.9 mm x 4.1 mm). It uses square cores and a unique patented circuit design to achieve very flat coupling making it ideal for use in wideband applications.

KEY FEATURES

Feature	Advantages
Wide Bandwidth: 1-800 MHz	Ideal for use in CATV and instrumentation applications.
Very Flat Coupling: ± 0.2 dB	Coupled port output is flat over frequency range eliminating need for compensation circuits.
Very Low Loss: 0.3 dB typ.	When used at the output of the amplifiers, low loss minimizes the gain reduction and temperature rise of surrounding components, thus preserving performance and improving reliability.
Bi-Directional	ADCB has two coupled ports; one to sample power traveling from in-out port & the other for sampling power traveling from out to In-Port. Ideal for use in instrumentation applications for measuring ratio of the two powers (return loss).
High Directivity: 16-24 dB typ. to 400 MHz 15-24 dB typ. to 800 MHz	Minimizes the undesired power entering the coupled ports due to imperfect source and load impedances resulting in improved system performance.
Excellent Return Loss: 20-40 dB typ. to 400 MHz	Excellent Return loss of ADCB minimizes interaction effects with adjacent circuits and resulting gain ripple.





ELECTRICAL SPECIFICATIONS¹ AT 25°C

Parameter	Condition (MHz)	Min.	Typ.	Max.	Units
Frequency Range		1		800	MHz
Mainline Loss ¹ (above theoretical 0.05 dB)	1	—	0.2	0.4	dB
	400	—	0.3	0.6	
	800	—	0.6	0.9	
Coupling	1-800		20.2		dB
	1	19.5	20.2	20.9	
	400	19.5	20.4	21.6	
Coupling Flatness(±)	1-400	—	0.2	0.6	dB
	400-800	—	0.2	0.7	
	800	18.5	20.2	21.8	
Directivity	1	15	20	—	dB
	400	14	24.4	—	
	800	10	15	—	
Return Loss (Input)	1	21	28	—	dB
	400	15	21	—	
	800	11	16	—	
Return Loss (Output)	1	21	27	—	dB
	400	15	22	—	
	800	11	17	—	
Return Loss (Coupled)	1	18	24	—	dB
	400	14	19	—	
	800	11	15	—	
Input Power	1-10	—	—	0.5	W
	10-800	—	—	1.0	

1. Mainline loss includes theoretical power loss at coupled port.

MAXIMUM RATINGS

Parameter	Ratings
Operating temperature	-40°C to 85°C
Storage temperature	-55°C to 100°C

Permanent damage may occur if any of these limits are exceeded.

ELECTRICAL SCHEMATIC

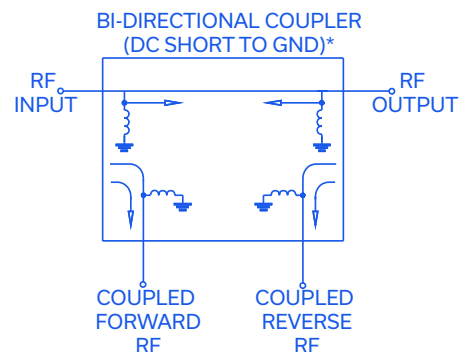

*Electrical schematic is for Bi-Directional coupler with internal transformer(s)



PIN CONNECTIONS

INPUT	1
OUTPUT	6
COUPLED (FORWARD)	3
COUPLED (REVERSE)	4
GROUND	2, 5

PRODUCT MARKING: N/A

DEMO BOARD MCL P/N: TB-211
SUGGESTED PCB LAYOUT (PL-097)

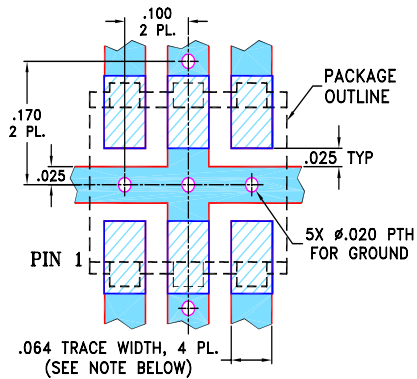

- NOTES: 1. TRACE WIDTH IS SHOWN FOR ROGERS R04350B WITH DIELECTRIC THICKNESS $.030 \pm .002$; COPPER: 1/2 OZ. EACH SIDE. FOR OTHER MATERIALS TRACE WIDTH MAY NEED TO BE MODIFIED.
 2. BOTTOM SIDE OF THE PCB IS CONTINUOUS GROUND PLANE.
- DENOTES PCB COPPER LAYOUT WITH SMOBC (SOLDER MASK OVER BARE COPPER)
 - DENOTES COPPER LAND PATTERN FREE OF SOLDER MASK

OUTLINE DRAWING

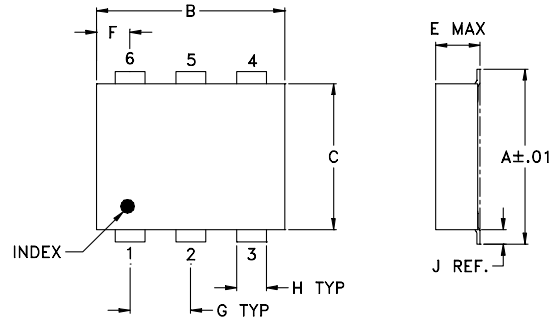

PBC Land Pattern

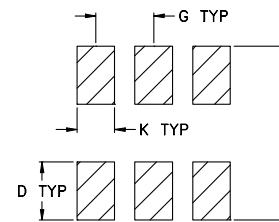

Suggested Layout

OUTLINE DIMENSIONS (Inches/mm)

A	B	C	D	E	F	G
.272	.310	.220	.100	.162	.055	.100
6.91	7.87	5.59	2.54	4.11	1.40	2.54
H	J	K	L	wt		
.030	.026	.065	.300	grams		
0.76	0.66	1.65	7.62	0.25		

TAPE & REEL INFORMATION: F34



TYPICAL PERFORMANCE DATA

Frequency (MHz)	Mainline Loss (dB)	Coupling (dB)		Directivity (dB)		Return Loss (dB)			
		In-Out	In-Cpl Fwd	Out-Cpl Rev	Out-Cpl Fwd	In-Cpl Rev	In	Out	Cpl Fwd
1.00	0.28	19.95	20.51	23.31	17.11	26.99	27.95	24.36	25.10
5.00	0.18	19.96	20.26	22.64	18.23	33.33	36.56	30.77	33.21
7.00	0.17	19.96	20.24	22.53	18.31	34.26	38.32	31.63	34.62
10.00	0.17	19.96	20.24	22.52	18.36	34.90	39.65	32.20	35.65
50.00	0.20	19.97	20.27	22.96	18.25	33.92	37.31	31.06	33.96
100.00	0.22	19.99	20.32	23.46	18.07	30.86	32.63	28.26	30.05
500.00	0.37	19.92	20.90	33.83	16.33	19.37	19.85	17.25	17.50
600.00	0.42	19.76	20.95	24.49	15.87	17.94	18.54	16.02	16.09
700.00	0.48	19.66	20.81	19.60	15.83	16.69	17.53	15.18	14.93
800.00	0.57	19.64	20.63	15.95	15.21	15.57	16.79	14.51	13.99

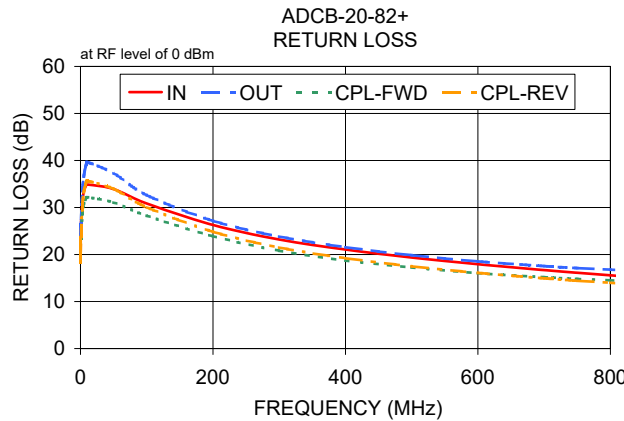
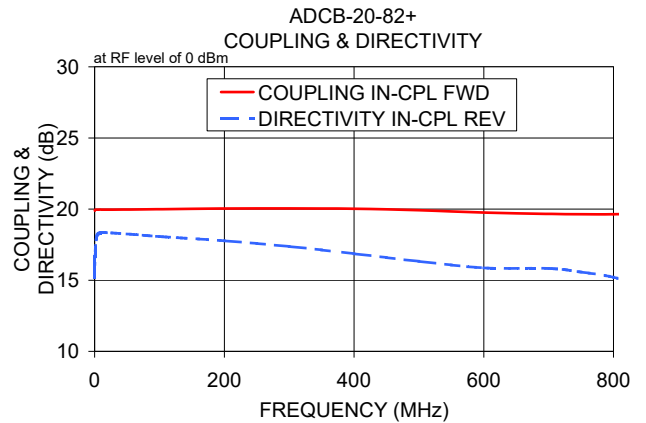
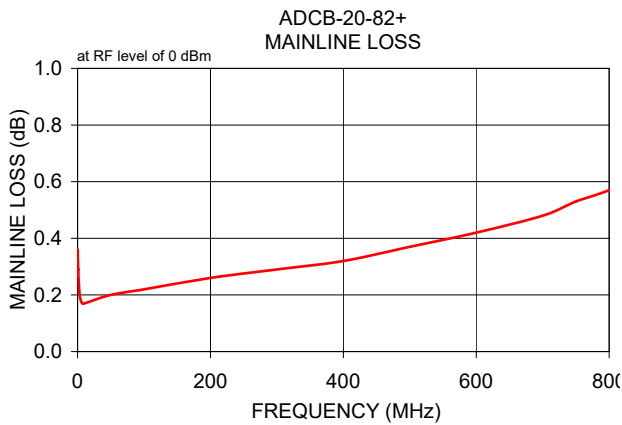

- NOTES**
- A. Performance and quality attributes and conditions not expressly stated in this specification document are intended to be excluded and do not form a part of this specification document.
 - B. Electrical specifications and performance data contained in this specification document are based on Mini-Circuit's applicable established test performance criteria and measurement instructions.
 - C. The parts covered by this specification document are subject to Mini-Circuits standard limited warranty and terms and conditions (collectively, "Standard Terms"); Purchasers of this part are entitled to the rights and benefits contained therein. For a full statement of the standard. Terms and the exclusive rights and remedies thereunder, please visit Mini-Circuits' website at www.minicircuits.com/MCLStore/terms.jsp