

AC Filter, Broad Band Attenuation



See below:  
[Approvals and Compliances](#)

**Description**

- Line-filter in standard version
- 1-stage
- high attenuation

**Characteristics**

- Designed for high current applications
- High attenuation at maximum resp. asymmetric load independent from the line impedance
- Especially designed for industrial applications such as: Frequency Converters, Stepper Motor Drives, UPS-Systems, Inverters
- Suitable for use in equipment according to IEC/UL 62368-1

**References**

Alternative: Standard version  
 We recommend for new applications the type [FMAB NEO](#)

**Weblinks**

[pdf data sheet](#), [html datasheet](#), [General Product Information](#), [Approvals](#), [Distributor-Stock-Check](#), [Detailed request for product](#), [Microsite](#)

**Technical Data**

Ratings IEC	12 - 50A @ Ta 40 °C / 250VAC; 50Hz
Ratings UL/CSA	12 - 50A @ Ta 40 °C / 125VAC; 60Hz
Leakage Current	industrial < 5.2mA (250V / 60Hz)
Dielectric Strength	> 1.7kVDC between L-N > 2.7kVDC between L/N-PE Test voltage (2 sec)
Allowable Operation Temperature	-25 °C to 100 °C
Climatic Category	25/100/21 acc. to IEC 60068-1
Protection Class	Suitable for appliances with protection class I acc. to IEC 61140
Terminal	Screw
Material: Housing	Metal

Line Filter	Industrial version, IEC 60939, UL 1283, CSA C22.2 no. 8 <a href="#">Technical Details</a>
MTBF	> 200'000h acc. to MIL-HB-217 F

**Approvals and Compliances**

Detailed information on product approvals, code requirements, usage instructions and detailed test conditions can be looked up in [Details about Approvals](#)

SCHURTER products are designed for use in industrial environments. They have approvals from independent testing bodies according to national and international standards. Products with specific characteristics and requirements such as required in the automotive sector according to IATF 16949, medical technology according to ISO 13485 or in the aerospace industry can be offered exclusively with customer-specific, individual agreements by SCHURTER.



**Approvals**

The approval mark is used by the testing authorities to certify compliance with the safety requirements placed on electronic products.  
 Approval Reference Type: FMAB

Approval Logo	Certificates	Certification Body	Description
	<a href="#">VDE Approvals</a>	VDE	Certificate Number: 40004673
	<a href="#">UL Approvals</a>	UL	UL File Number: E72928

**Product standards**

Product standards that are referenced

Organization	Design	Standard	Description
	Designed according to	IEC 60939	Passive filters for suppressing electromagnetic interference
	Designed according to	UL 1283	Electromagnetic interference filters
	Designed according to	CSA C22.2 no. 8	Electromagnetic interference (EMI) filters





**Application standards**

Application standards where the product can be used

Organization	Design	Standard	Description
	Designed for applications acc.	IEC/UL 62368-1	Audio/video, information and communication technology equipment - Part 1: Safety requirements

**Compliances**

The product complies with following Guide Lines

Identification	Details	Initiator	Description
	<a href="#">CE declaration of conformity</a>	SCHURTER AG	The CE marking declares that the product complies with the applicable requirements laid down in the harmonisation of Community legislation on its affixing in accordance with EU Regulation 765/2008.
	<a href="#">UKCA declaration of conformity</a>	SCHURTER AG	The UKCA marking declares that the product complies with the applicable requirements laid down in the British Amendment of Regulation (EC) 765/2008.
	RoHS	SCHURTER AG	Directive RoHS 2011/65/EU, Amendment (EU) 2015/863
	China RoHS	SCHURTER AG	The law SJ / T 11363-2006 (China RoHS) has been in force since 1 March 2007. It is similar to the EU directive RoHS.
	REACH	SCHURTER AG	On 1 June 2007, Regulation (EC) No 1907/2006 on the Registration, Evaluation, Authorization and Restriction of Chemicals 1 (abbreviated as "REACH") entered into force.

**Dimension [mm]**

Case 24-2

Case 24-6

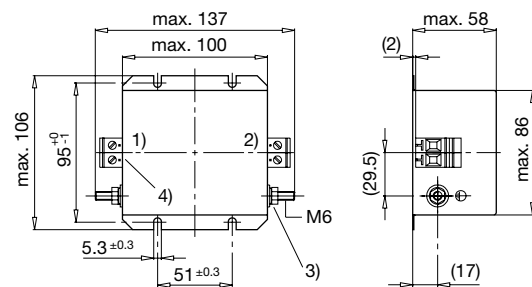
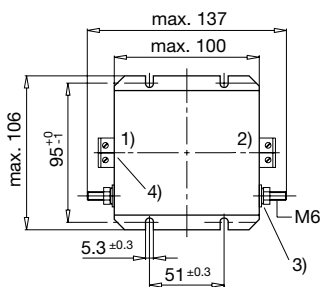

- 1) Line
- 2) Load
- 3) Nut torque 3...4 Nm
- 4) I/O Connections torque 0.6...0.8

- 1) Line
- 2) Load
- 3) Nut torque 3...4 Nm
- 4) I/O Connections torque 1.5...1.8

Case 79-2

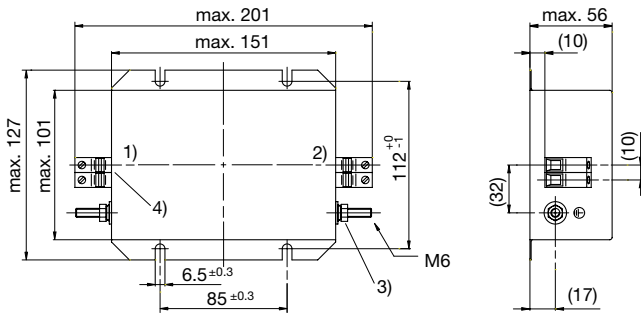

- 1) Line
- 2) Load
- 3) Nut torque 3...4 Nm
- 4) I/O Connections torque 1.5...1.8

Diagrams

Standard version

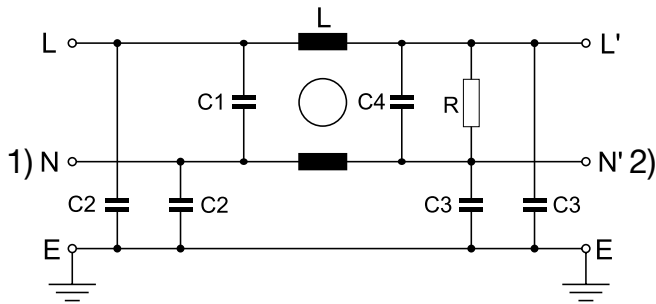

- 1) Line
- 2) Load

Attenuation Loss

----- 50Ω differential mode    \_\_\_\_ 50Ω common mode

Industrial version

12 A

20 A

30 A

50 A

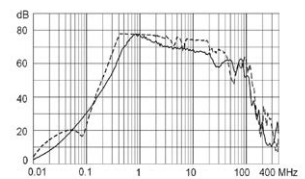
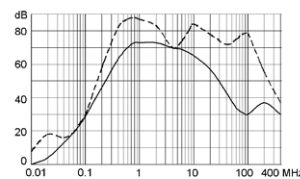
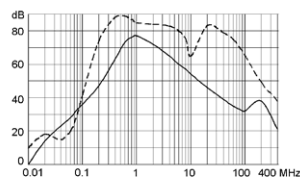
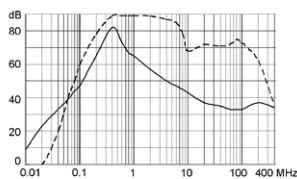

All Variants

Rated Current [A]	Filter-Type	Leakage Current [mA]	L [mH]	C1 (X2) [µF]	C2 (Y2) [nF]	C3 (Y2) [nF]	C4 (X2) [µF]	R [MΩ]	Clamps [mm <sup>2</sup> ]	Weight [g]	Housing	Order Number
12	Industrial version	5.2	2 x 10	2.2	10	47	1	1	4	927 g	24-2	5500.2064
20	Industrial version	5.2	2 x 3.5	2.2	10	47	1	1	4	930 g	24-2	5500.2065
30	Industrial version	5.6	2 x 1.5	2.2	15	47	1	1	6	970 g	24-6	5500.2066
50	Industrial version	5.6	2 x 1.5	2.2	15	47	1	1	10	970 g	79-2	5500.2067

Availability for all products can be searched real-time: <https://www.schurter.com/en/Stock-Check/Stock-Check-SCHURTER>

Packaging unit

2 Pcs