



Model 3410

Electronic LCD Hour Meter

EVALUATION KIT AVAILABLE

Contact us to request yours



The Model 3410 LCD Hour Meter provides a large display with 0.28" [7mm] high characters, available in 5 different industry size housings.

A wide operating voltage, 10-300VDC and 20-300VAC, makes the model 34 versatile for all indoor and outdoor applications. All models are NEMA 4/4X, 12 & IP66 rated when used with the optional gasket and have a polarized lens which assures high visibility in an outdoor environment.

Key Features

- Totally sealed from moisture and dirt
- AC and DC voltage input in the same unit
- Compact depth
- Fits in existing panel openings
- Always on display

Options

- A choice of 5 housings
- Optional Remote Reset

Applications

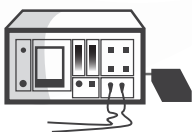

Medical Devices



Generators

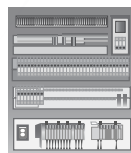

Control Panel



Production Equipment



Garden Tractor



Marine Equipment

Specifications

Display	LCD with large 0.28" [7mm] high figures black on light background
Run Indicator	Blinking decimal point
Reset	Remote and non-reset
Resolution	0.1 Hour displayed
Accuracy	± 0.1% @ room temperature ± 0.2% over the specified temperature range
Records & Displays	9999999.9 (hours and 1/10ths)
Inputs	10-300VDC and 20-300VAC - 50/60Hz <2mA VIH 20VAC or 10VDC minimum VIL 3VAC or 3VDC maximum
Power	Self-powered - battery life 10+ years (battery life reduced to 5 years for temps above 100°F/37.8°C)
Terminations	Standard 0.250" [6.4mm] spades
Enclosure	Totally sealed from moisture and dirt. NEMA 4/4X, 12 & IP66 compliant from the front when properly mounted using the optional gasket. (Not applicable in the Snap-In Model)
Environmental: Temp.	Operating Temp.: -10°C to +60°C [14°F to +140°F] Storage Temp.: -20°C to +70°C [-4°F to +158°F]
Humidity	95% RH per SAE J1378
Vibration	20g @ 10 to 80 Hz per SAE J1378 Shock: 44 to 55g's per SAE J1378
Dielectric Compliance	1000VAC 50/60 Hz for 1 minute (34x0 models only) Compliant to the European WEEE and RoHS Directives
Sealing	Totally sealed
EMC Compliance	EN61326
Protection Against	Alternator load dump: 150V EMI (Electromagnetic Interface): +400V @ 500Hz inductive switching and reverse polarity
Weight	1 oz. [28g]
Approvals	UL & cUL recognized (file # ELIY2.E36690), CE, SAE, UKCA, NEMA 4/4X/IP66 compliant (not including 3410-2210)

Dimensions

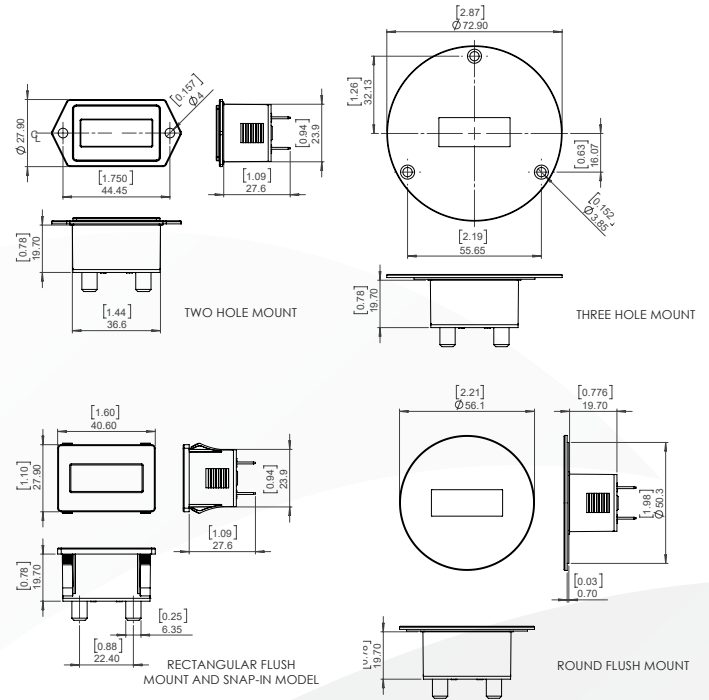

Notes:

- When interfacing the Model 34 with a Solid State Relay or AC Sensor, the leakage current needs to be considered.
- Exceeding the Absolute Voltage Range and the Absolute Maximum Limits may result in damage to the unit.

Part Numbers

Part Number	Description	Gasket
3410-0000	AC/DC Hour Meter 2-hole case 1/4" spade terminal non-reset	5003-010
3410-0010	AC/DC Hour Meter 2-hole case 1/4" spade terminal remote-reset	5003-010
3410-1000	AC/DC Hour Meter 3-hole case 1/4" spade terminals non-reset	5003-017
3410-1010	AC/DC Hour Meter 3-hole case 1/4" spade terminals remote-reset	5003-017
3410-2000	AC/DC Hour Meter flush rectangular case 1/4" spade terminals non-reset	5003-009
3410-2010	AC/DC Hour Meter flush rectangular case 1/4" spade terminals remote-reset	5003-009
3410-3000	AC/DC Hour Meter round SAE case 1/4" spade terminals non-reset	5003-009
3410-3010	AC/DC Hour Meter round SAE case 1/4" spade terminals remote-reset **special order** MOQ=50pcs	5003-009
3410-5000	AC/DC Hour Meter snap-in case 1/4" spade terminals non-reset	
3410-5010	AC/DC Hour Meter snap-in case 1/4" spade terminals remote reset	
5003-010	NEMA 4X Gasket two hole mount	
5003-017	NEMA 4X Gasket three hole mount	
5003-009	NEMA 4X Gasket flush rectangular and SAE round mount	
3410-0004-EVAL	3410 Evaluation Kit	

