

TOSHIBA CMOS Linear Integrated Circuit Silicon Monolithic

TCK127BG

0.08 nA Ultra small IQ 1.0 A Load Switch IC in Ultra Small Package

TCK127BG is load switch IC for a general power management with slew rate control driver, featuring super low quiescent current, low switch ON resistance and wide input operation voltage range from 1.0 to 5.5 V.

Quiescent current is only 0.08 nA and output current is available up to 1.0 A. TCK127BG also feature output auto-discharge function.

This device is available in 0.35 mm pitch ultra small package WCSP4G (0.645 mm x 0.645 mm, t: 0.465 mm max.) with back side coating that protect from external damage.

Thus this device is ideal for portable applications that require high-density board assembly and ultra low power consumption such as wearables, smartphones, and IoT modules.

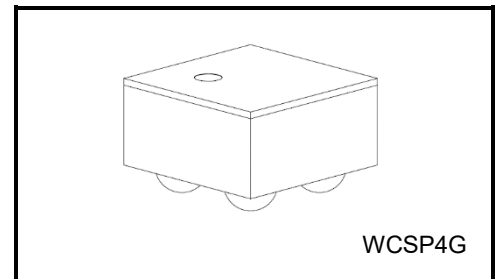

Weight: 0.38 mg (typ.)

Feature

- Wide input operation voltage range : $V_{IN} = 1.0$ to 5.5 V
- High output current : $I_{OUT} = 1.0$ A
- Ultra small quiescent current : $I_Q = 0.08$ nA at $V_{IN} = V_{CT} = 5.5$ V, $I_{OUT} = 0$ mA
- Low ON resistance
 $R_{ON} = 58$ m Ω (typ.) at $V_{IN} = 3.3$ V, $I_{OUT} = -0.5$ A
 $R_{ON} = 106$ m Ω (typ.) at $V_{IN} = 1.8$ V, $I_{OUT} = -0.5$ A
- Built in Slew rate control driver
- Built in Auto-discharge
- Active High
- Ultra small package : WCSP4G with back side coating (0.645 mm x 0.645 mm, t: 0.465 mm max.)

Pin Assignment(Top view)

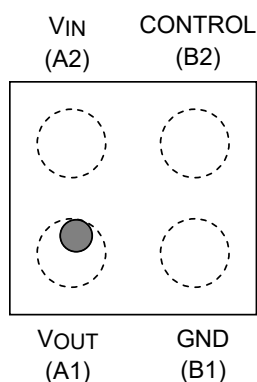

Top marking

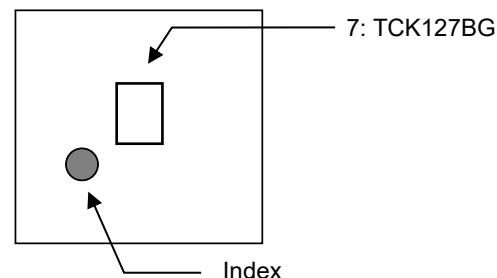

Start of commercial production
2021-11

Absolute Maximum Ratings (Ta = 25°C)

Characteristics	Symbol	Rating	Unit	
Input voltage	V _{IN}	-0.3 to 6.0	V	
Control voltage	V _{CT}	-0.3 to 6.0	V	
Output voltage	V _{OUT}	-0.3 to V _{IN} +0.3	V	
Output current	I _{OUT}	DC	1.0	A
		Pulse	2.0 (Note 1)	A
Power dissipation	P _D	1.0 (Note 2)	W	
Junction temperature	T _j	150	°C	
Storage temperature	T _{stg}	-55 to 150	°C	

Note: Using continuously under heavy loads (e.g. the application of high temperature/current/voltage and the significant change in temperature, etc.) may cause this product to decrease in the reliability significantly even if the operating conditions (i.e. operating temperature/current/voltage, etc.) are within the absolute maximum ratings and the operating ranges.

Please design the appropriate reliability upon reviewing the Toshiba Semiconductor Reliability Handbook (“Handling Precautions”/“Derating Concept and Methods”) and individual reliability data (i.e. reliability test report and estimated failure rate, etc).

Note1: 300 μs pulse, 2% duty cycle

Note2: Rating at mounting on a board
 Glass epoxy board dimension : 40 mm x 40 mm , 4 layer
 Metal pattern ratio : approximately 70% each layer

Block Diagram

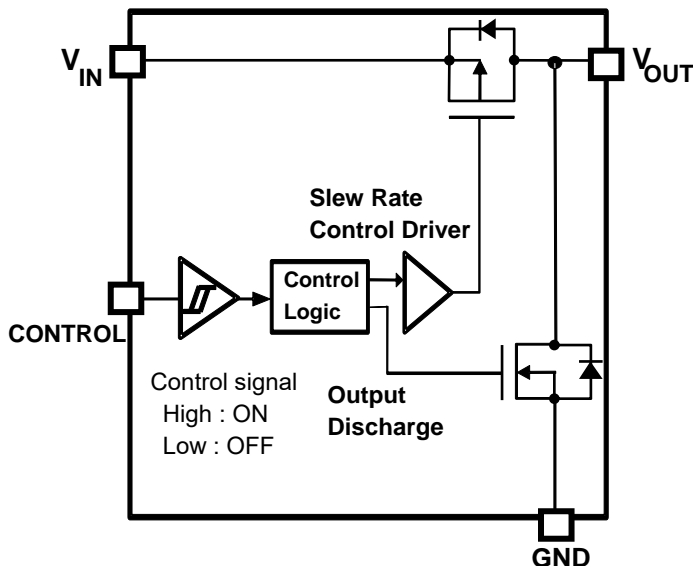

Operating conditions

Characteristics	Symbol	Condition	Min	Max	Unit
Input voltage	V _{IN}	—	1.0	5.5	V
Output current	I _{OUT}	—	—	1.0	A
CONTROL High-level input voltage	V _{IH}	1.0 V ≤ V _{IN} ≤ 5.5 V	0.9	—	V
CONTROL Low-level input voltage	V _{IL}		—	0.4	V
Operating Ambient temperature range	T _{a_opr}	—	-40	85	°C

Electrical Characteristics

DC Characteristics

Characteristics	Symbol	Test Condition	Ta = 25°C			Ta = -40 to 85°C (Note 2)			Unit
			Min	Typ.	Max	Min	Typ.	Max	
Quiescent current (ON state)	I _Q	V _{IN} = V _{CT} = 5.5 V, I _{OUT} = 0 mA	—	0.08	8	—	4.1 (Note 3)	100	nA
Standby current (OFF state)	I _{Q(OFF)} + I _{SD(OFF)}	V _{IN} = 1.0 V, V _{CT} = 0 V, V _{OUT} = OPEN	—	0.6	—	—	—	—	nA
		V _{IN} = 4.5 V, V _{CT} = 0 V, V _{OUT} = OPEN	—	3	—	—	86 (Note 3)	—	nA
		V _{IN} = 5.5 V, V _{CT} = 0 V, V _{OUT} = OPEN	—	13	45	—	148 (Note 3)	550	nA
On resistance	R _{ON}	V _{IN} = 5.0 V, I _{OUT} = -0.5 A	—	46	—	—	—	68	mΩ
		V _{IN} = 3.3 V, I _{OUT} = -0.5 A	—	58	—	—	—	87	
		V _{IN} = 1.8 V, I _{OUT} = -0.5 A	—	106	—	—	—	169	
		V _{IN} = 1.2 V, I _{OUT} = -0.2 A	—	210	—	—	—	450	
		V _{IN} = 1.0 V, I _{OUT} = -0.05 A	—	343	—	—	—	—	
Discharge on resistance	R _{SD}	V _{IN} = 3.3 V, I _{OUT} = 0.01 A	—	109	—	—	—	—	Ω

Note 2 : This parameter is warranted by design.

Note 3 : Ta = 85°C

AC Characteristics (Ta = 25°C)

V_{IN} = 1.2 V

Characteristics	Symbol	Test Condition (Figure 1)	Min	Typ.	Max	Unit
V _{OUT} rise time	t _r	R _L = 500 Ω, C _L = 0.1 μF	—	197	—	μs
V _{OUT} fall time	t _f	R _L = 500 Ω, C _L = 0.1 μF	—	24	—	μs
Turn on delay	t _{ON}	R _L = 500 Ω, C _L = 0.1 μF	—	335	—	μs
Turn off delay	t _{OFF}	R _L = 500 Ω, C _L = 0.1 μF	—	6	—	μs

V_{IN} = 3.3 V

Characteristics	Symbol	Test Condition (Figure 1)	Min	Typ.	Max	Unit
V _{OUT} rise time	t _r	R _L = 500 Ω, C _L = 0.1 μF	—	363	—	μs
V _{OUT} fall time	t _f	R _L = 500 Ω, C _L = 0.1 μF	—	32	—	μs
Turn on delay	t _{ON}	R _L = 500 Ω, C _L = 0.1 μF	—	324	—	μs
Turn off delay	t _{OFF}	R _L = 500 Ω, C _L = 0.1 μF	—	10	—	μs

AC Waveform

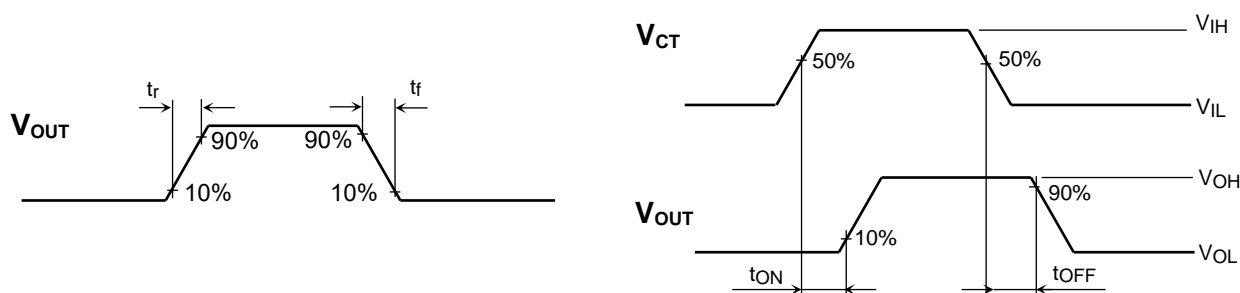
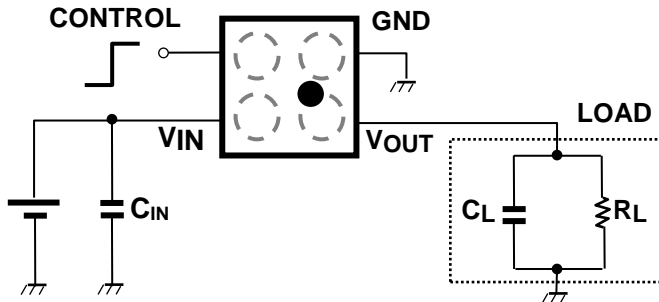

Figure 1 t_r, t_f, t_{ON}, t_{OFF} Waveforms

Application Note

1. Application circuit example (top view)

The figure below shows the example of configuration for TCK127BG.



Part number	Control voltage	IC Operation
TCK127BG	HIGH	ON
	LOW	OFF

1) Input capacitor

An input capacitor (C_{IN}) is not necessary for the guaranteed operation of TCK127BG. However, it is recommended to use input capacitors to reduce voltage drop due to sharp changes in output current and also for improved stability of the power supply. When used, place C_{IN} as close to V_{IN} pin to improve stability of the power supply. Also, due to the C_{IN} selected, $V_{IN} < V_{OUT}$ may occur, causing a reverse current to flow through the body diode of the pass-through p-ch MOSFET of the load switch IC. In this case, a higher value for C_{IN} as compared to C_L is recommended.

2) Output capacitor

An output capacitor (C_{OUT}) is not necessary for the guaranteed operation of TCK127BG. However, there is a possibility of overshoot or undershoot caused by output load transient response, board layout and parasitic components of load switch IC. In this case, an output capacitor with C_{OUT} more than $0.1\mu\text{F}$ is recommended.

3) Control pin

A control pin for TCK127BG is Active High. This pin controls the pass-through p-ch MOSFET and the discharge n-ch MOSFET, operated by the control voltage (V_{CT}). The control pin is equipped with Schmitt trigger. When the control voltage level is High, p-ch MOSFET is ON state and discharge n-ch MOSFET is OFF state. When control voltage level is Low, and the state of the MOSFETs is reversed. In addition, control pin has a tolerant function such that it can be used even if the control voltage is higher than the input voltage.

4) Control voltage for Low Quiescent current

If there is a difference between the control voltage and the input voltage, the current consumption may increase due to the circuit configuration. Therefore, it is recommended to use same voltage with V_{IN} or 0 V as the control voltage for use with ultra-low current consumption.

5) Low input voltage and output voltage attenuation

When TCK127BG is used at a low V_{IN} voltage, the R_{ON} becomes high, so there is output voltage attenuation when a large current flows. Therefore, carefully check the required output current and output voltage before use.

6) Assembly

If you use potting materials that contain halogen groups such as sulfur and chlorine, characteristic defects may occur due to corrosion or conductive ions. Therefore, do not use potting materials that contain halogen groups such as sulfur or chlorine. Also, regarding the use of potting materials, be sure to thoroughly check the electrical characteristics and reliability tests of the customer before use. This product has a back side coating (BSC), but it does not provide complete protection from mechanical impacts. When picking up or testing the product, be very careful not to damage it.

2. Power Dissipation

Board-mounted power dissipation ratings are available in the Absolute Maximum Ratings table. Power dissipation is measured on the board condition shown below.

[The Board Condition]

Glass epoxy board dimension : 40 mm x 40 mm , 4 layer

Metal pattern ratio : approximately 70% each layer

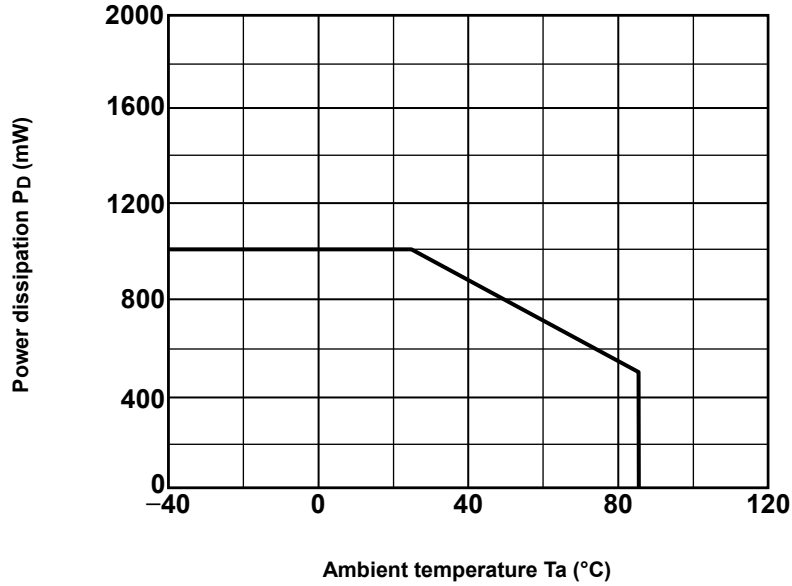

Please allow sufficient margin when designing a board pattern to fit the expected power dissipation. Also take into consideration the ambient temperature, input voltage, output current etc. and applying the appropriate derating for allowable power dissipation during operation.

Representative Typical Characteristics

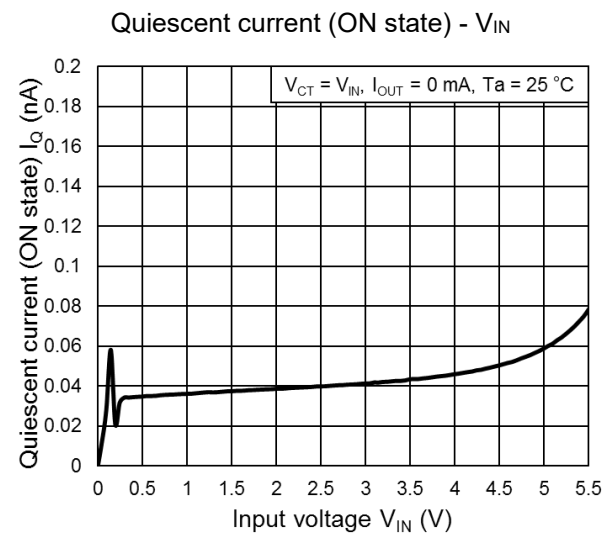
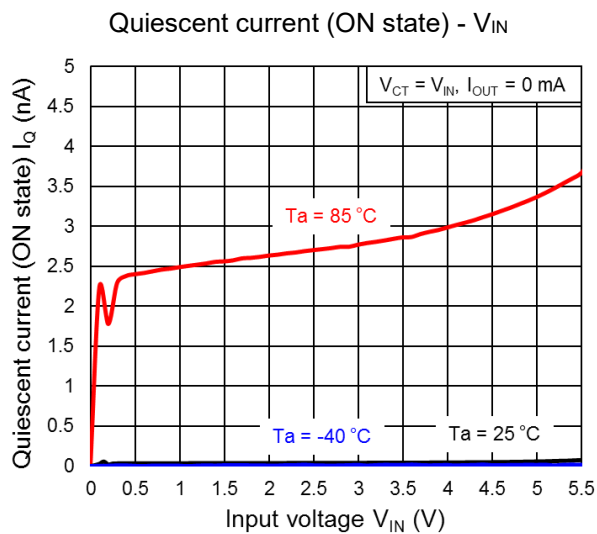
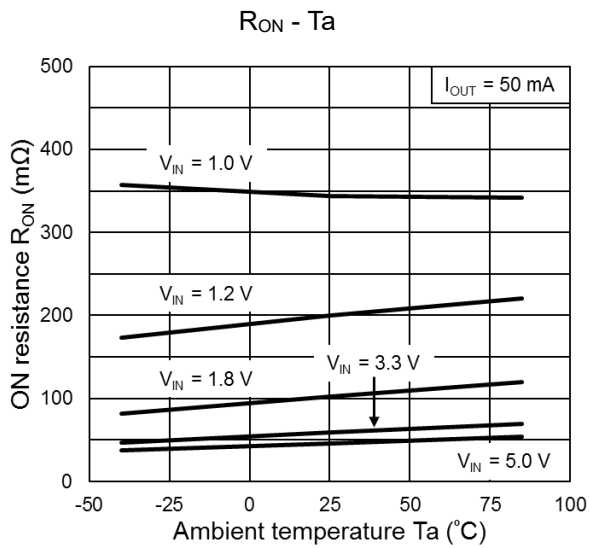
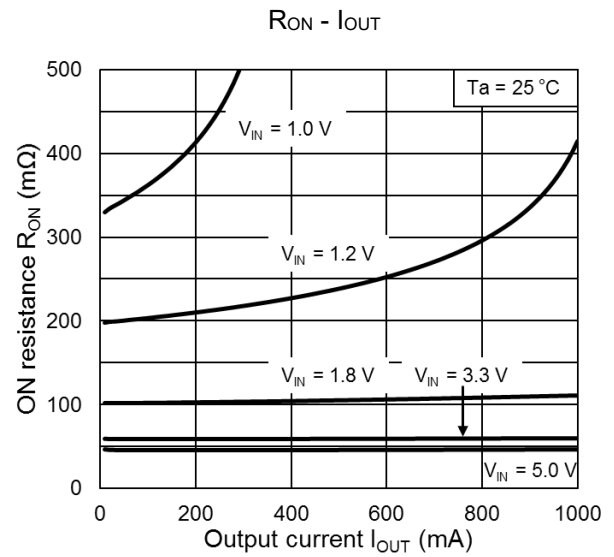
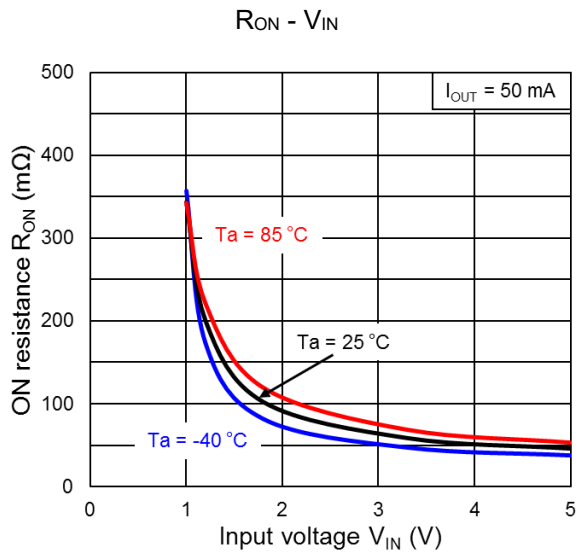

Representative Typical Characteristics

Standby current (OFF state) - V_{IN}

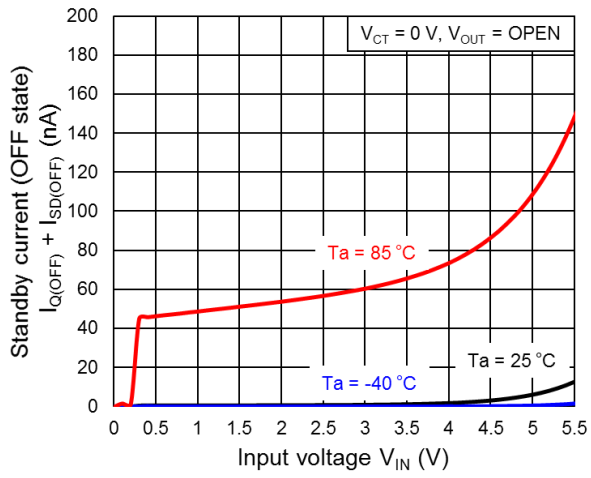

Standby current (OFF state) - V_{IN}

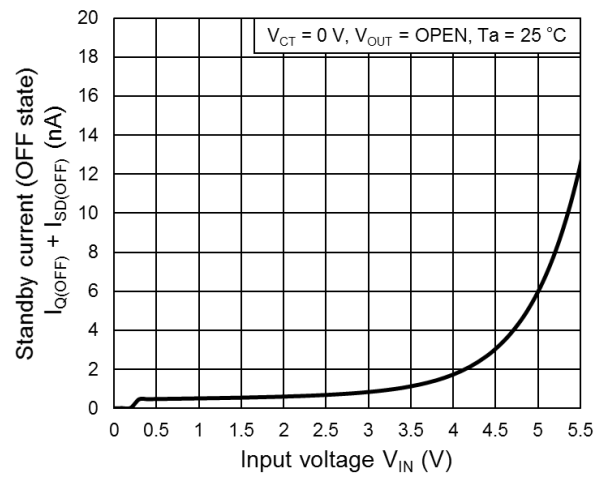

t_{ON} Response

V_{IN} = 1.2 V, C_L = 0.1 μF, R_L = 500 Ω

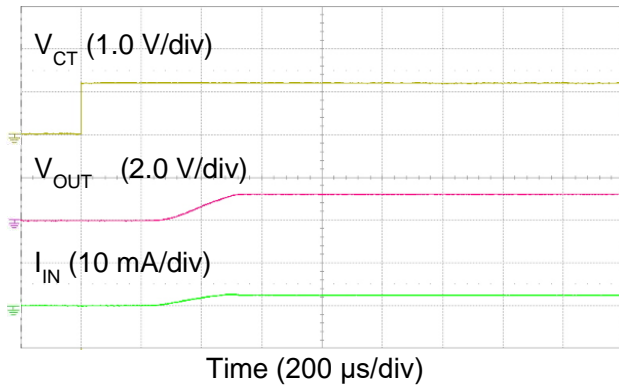

V_{IN} = 1.2 V, C_L = 4.7 μF, R_L = 500 Ω

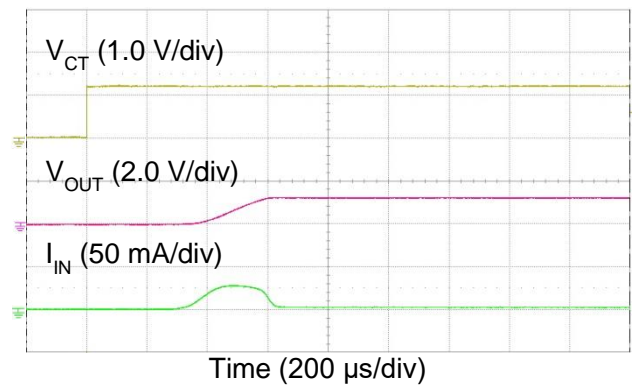

V_{IN} = 1.8 V, C_L = 0.1 μF, R_L = 500 Ω

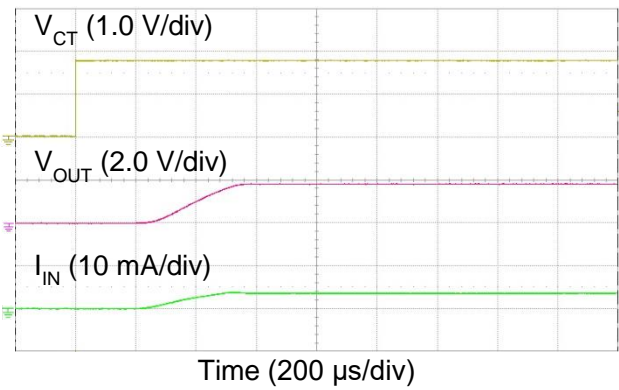

V_{IN} = 1.8 V, C_L = 4.7 μF, R_L = 500 Ω

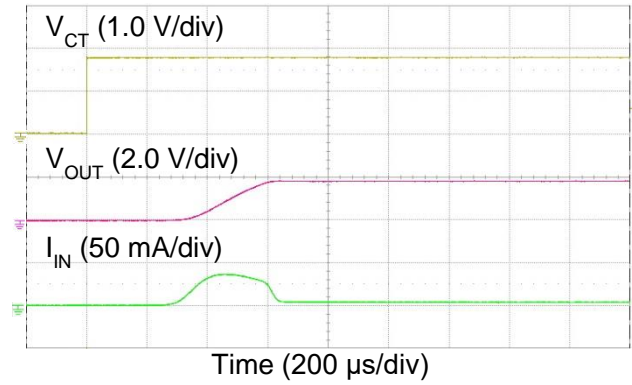

V_{IN} = 3.3 V, C_L = 0.1 μF, R_L = 500 Ω

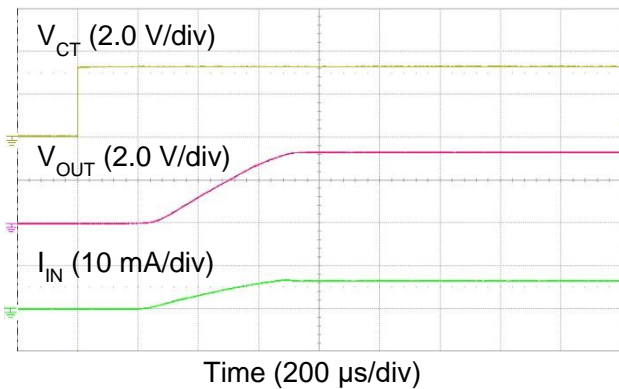

V_{IN} = 3.3 V, C_L = 4.7 μF, R_L = 500 Ω

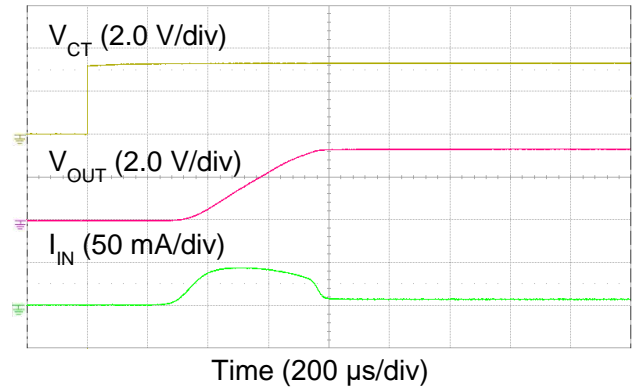

t_{OFF} Response

V_{IN} = 1.2 V, C_L = 0.1 μF, R_L = 500 Ω

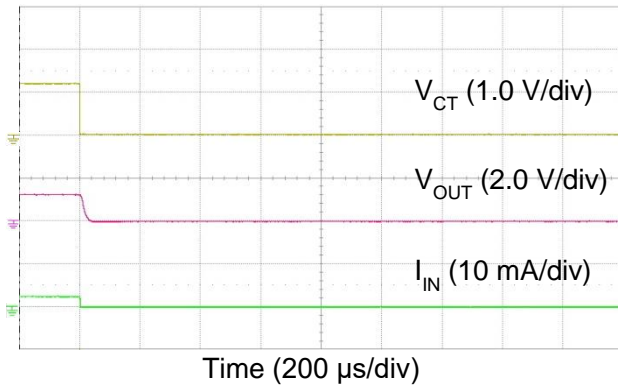

V_{IN} = 1.2 V, C_L = 4.7 μF, R_L = 500 Ω

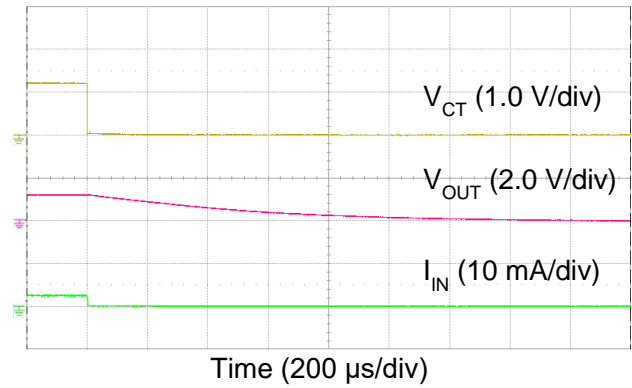

V_{IN} = 1.8 V, C_L = 0.1 μF, R_L = 500 Ω

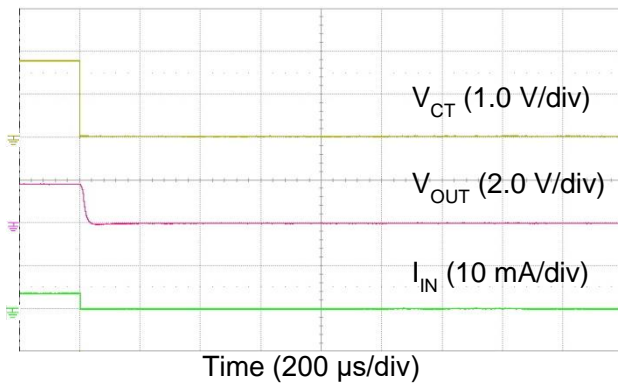

V_{IN} = 1.8 V, C_L = 4.7 μF, R_L = 500 Ω

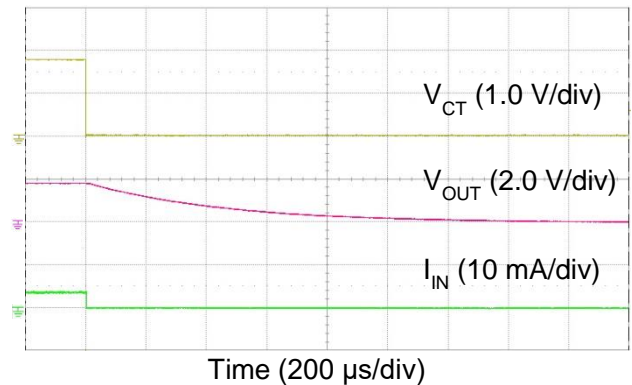

V_{IN} = 3.3 V, C_L = 0.1 μF, R_L = 500 Ω

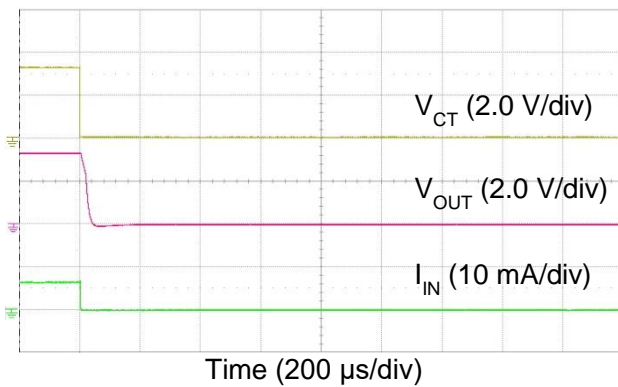

V_{IN} = 3.3 V, C_L = 4.7 μF, R_L = 500 Ω

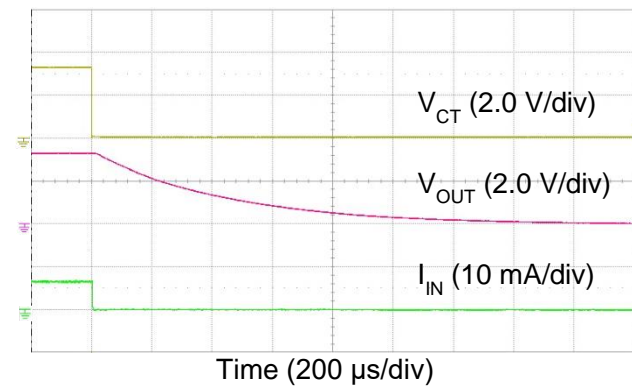

Note: The above characteristics curves are presented for reference only and not guaranteed by production test, unless otherwise noted.

Package Information

WCSP4G

Unit: mm

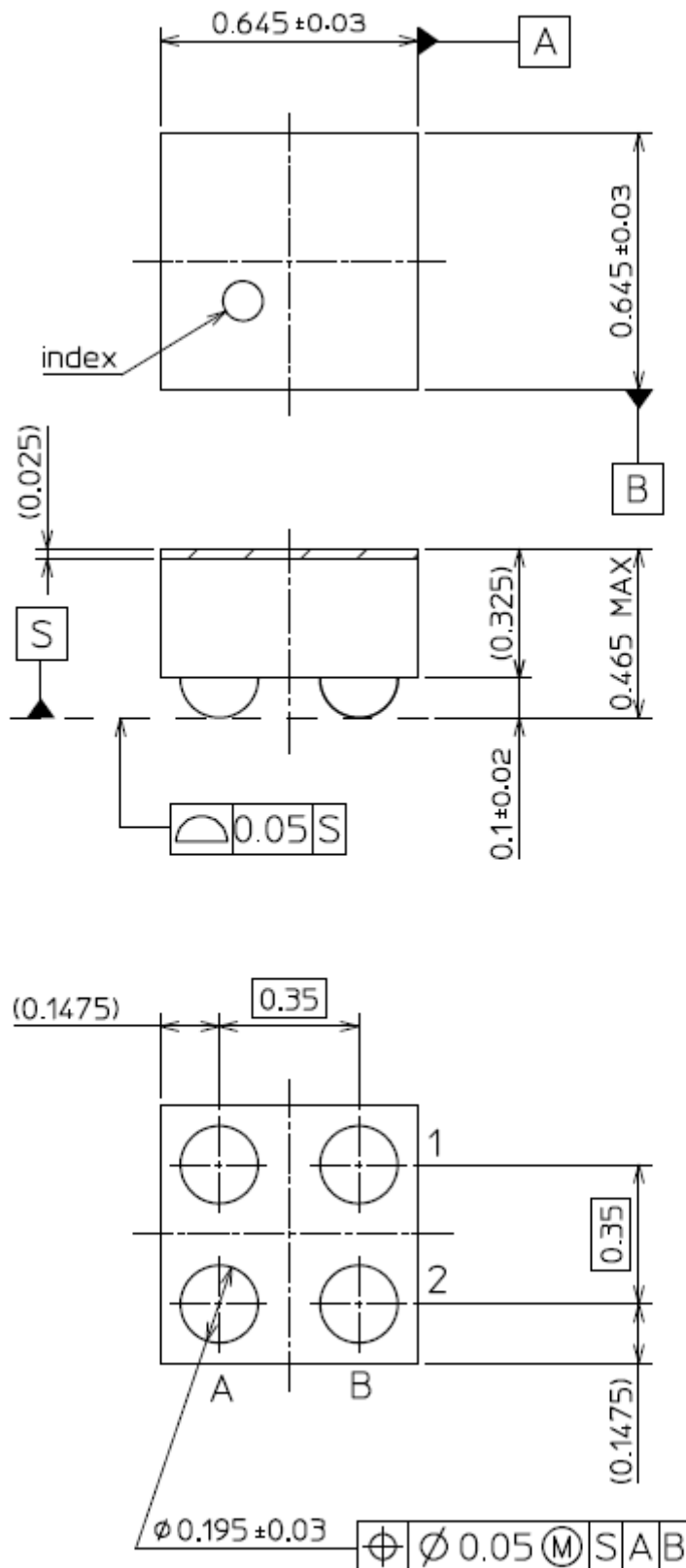

Weight: 0.38 mg (typ.)

Land pattern dimensions for reference only

Unit: mm

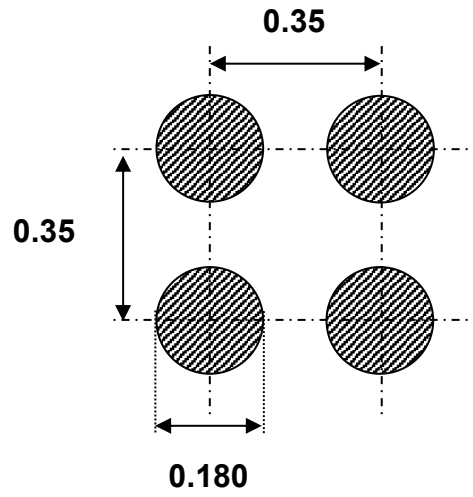

RESTRICTIONS ON PRODUCT USE

Toshiba Corporation and its subsidiaries and affiliates are collectively referred to as "TOSHIBA". Hardware, software and systems described in this document are collectively referred to as "Product".

- TOSHIBA reserves the right to make changes to the information in this document and related Product without notice.
- This document and any information herein may not be reproduced without prior written permission from TOSHIBA. Even with TOSHIBA's written permission, reproduction is permissible only if reproduction is without alteration/omission.
- Though TOSHIBA works continually to improve Product's quality and reliability, Product can malfunction or fail. Customers are responsible for complying with safety standards and for providing adequate designs and safeguards for their hardware, software and systems which minimize risk and avoid situations in which a malfunction or failure of Product could cause loss of human life, bodily injury or damage to property, including data loss or corruption. Before customers use the Product, create designs including the Product, or incorporate the Product into their own applications, customers must also refer to and comply with (a) the latest versions of all relevant TOSHIBA information, including without limitation, this document, the specifications, the data sheets and application notes for Product and the precautions and conditions set forth in the "TOSHIBA Semiconductor Reliability Handbook" and (b) the instructions for the application with which the Product will be used with or for. Customers are solely responsible for all aspects of their own product design or applications, including but not limited to (a) determining the appropriateness of the use of this Product in such design or applications; (b) evaluating and determining the applicability of any information contained in this document, or in charts, diagrams, programs, algorithms, sample application circuits, or any other referenced documents; and (c) validating all operating parameters for such designs and applications. **TOSHIBA ASSUMES NO LIABILITY FOR CUSTOMERS' PRODUCT DESIGN OR APPLICATIONS.**
- **PRODUCT IS NEITHER INTENDED NOR WARRANTED FOR USE IN EQUIPMENTS OR SYSTEMS THAT REQUIRE EXTRAORDINARILY HIGH LEVELS OF QUALITY AND/OR RELIABILITY, AND/OR A MALFUNCTION OR FAILURE OF WHICH MAY CAUSE LOSS OF HUMAN LIFE, BODILY INJURY, SERIOUS PROPERTY DAMAGE AND/OR SERIOUS PUBLIC IMPACT ("UNINTENDED USE").** Except for specific applications as expressly stated in this document, Unintended Use includes, without limitation, equipment used in nuclear facilities, equipment used in the aerospace industry, lifesaving and/or life supporting medical equipment, equipment used for automobiles, trains, ships and other transportation, traffic signaling equipment, equipment used to control combustions or explosions, safety devices, elevators and escalators, and devices related to power plant. **IF YOU USE PRODUCT FOR UNINTENDED USE, TOSHIBA ASSUMES NO LIABILITY FOR PRODUCT.** For details, please contact your TOSHIBA sales representative or contact us via our website.
- Do not disassemble, analyze, reverse-engineer, alter, modify, translate or copy Product, whether in whole or in part.
- Product shall not be used for or incorporated into any products or systems whose manufacture, use, or sale is prohibited under any applicable laws or regulations.
- The information contained herein is presented only as guidance for Product use. No responsibility is assumed by TOSHIBA for any infringement of patents or any other intellectual property rights of third parties that may result from the use of Product. No license to any intellectual property right is granted by this document, whether express or implied, by estoppel or otherwise.
- **ABSENT A WRITTEN SIGNED AGREEMENT, EXCEPT AS PROVIDED IN THE RELEVANT TERMS AND CONDITIONS OF SALE FOR PRODUCT, AND TO THE MAXIMUM EXTENT ALLOWABLE BY LAW, TOSHIBA (1) ASSUMES NO LIABILITY WHATSOEVER, INCLUDING WITHOUT LIMITATION, INDIRECT, CONSEQUENTIAL, SPECIAL, OR INCIDENTAL DAMAGES OR LOSS, INCLUDING WITHOUT LIMITATION, LOSS OF PROFITS, LOSS OF OPPORTUNITIES, BUSINESS INTERRUPTION AND LOSS OF DATA, AND (2) DISCLAIMS ANY AND ALL EXPRESS OR IMPLIED WARRANTIES AND CONDITIONS RELATED TO SALE, USE OF PRODUCT, OR INFORMATION, INCLUDING WARRANTIES OR CONDITIONS OF MERCHANTABILITY, FITNESS FOR A PARTICULAR PURPOSE, ACCURACY OF INFORMATION, OR NONINFRINGEMENT.**
- Do not use or otherwise make available Product or related software or technology for any military purposes, including without limitation, for the design, development, use, stockpiling or manufacturing of nuclear, chemical, or biological weapons or missile technology products (mass destruction weapons). Product and related software and technology may be controlled under the applicable export laws and regulations including, without limitation, the Japanese Foreign Exchange and Foreign Trade Law and the U.S. Export Administration Regulations. Export and re-export of Product or related software or technology are strictly prohibited except in compliance with all applicable export laws and regulations.
- Please contact your TOSHIBA sales representative for details as to environmental matters such as the RoHS compatibility of Product. Please use Product in compliance with all applicable laws and regulations that regulate the inclusion or use of controlled substances, including without limitation, the EU RoHS Directive. **TOSHIBA ASSUMES NO LIABILITY FOR DAMAGES OR LOSSES OCCURRING AS A RESULT OF NONCOMPLIANCE WITH APPLICABLE LAWS AND REGULATIONS.**