

TRANSFORMERS FOR DIGITAL AUDIO DATA TRANSMISSION



For Use with Cirrus Logic's CS8401, CS8402, CS8403 & CS8404 ICs



- Operating transmission rates: 1 to 7 Mbps
- Controlled rise time: 25 nsec MAX
- High isolation voltage: 2 kV MIN

Electrical Specifications @ 25°C — Operating Temperature 0°C to 70°C

RoHS-6 Compliant Part No.	Turns Ratio (±5%)	Primary Inductance (mH ±20%)	L _L (μH) MAX	Rise Time (nsec) MAX	ET (V-μsec) MIN	Isolation (Vrms) MIN	Bandwidth (100 KHz-55 MHz) TYP	Return Loss (100 kHz-10 MHz) MIN	Schematic
PE-65612NL	1:1	2.5	.50	25	20	2000	3 dB	20 dB	THT

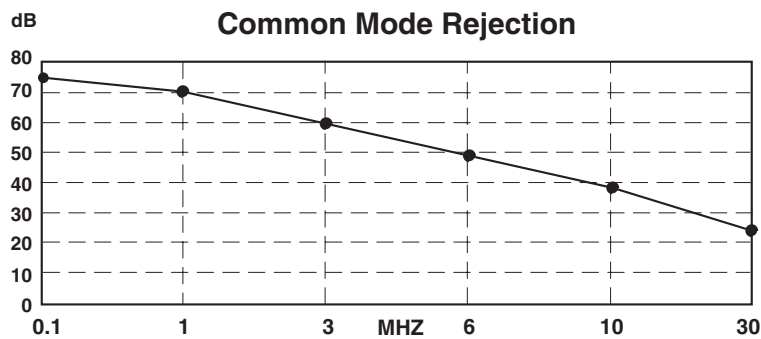

Mechanical

Schematic

PE-65612NL

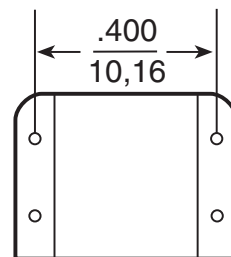
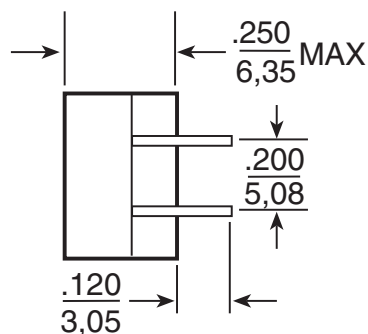
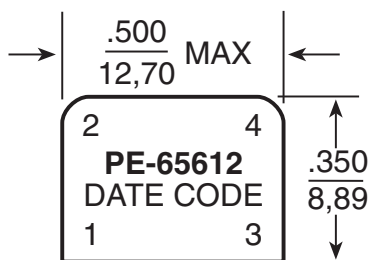

Leads are 24 AWG-solderable

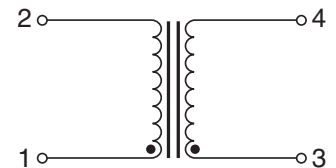

PE-65612NL
 Weight.....1.2 grams
 Tape & Reel.....NA
 Tube.....60/tube

Dimensions: Inches
 mm

Unless otherwise specified all tolerances are ± .010
 0,25

TRANSFORMERS FOR DIGITAL AUDIO DATA TRANSMISSION

For Use with Cirrus Logic's CS8401, CS8402, CS8403 & CS8404 ICs

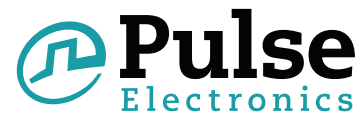

Application

This transformer has been designed for use at the interface between line driver and receiver and the interconnecting medium in Digital Audio Data Transmission Systems according to AES 3-199X or IEC 958. In such systems, two channels of periodically sampled and uniformly quantized audio signals are transmitted on a single shielded twisted pair.

The electrical parameters of the interface are based on those of CCITT V.11 or balanced voltage digital circuits which allow signal transmission up to a few hundred meters. The isolation transformers are essential in improving the balance of the transmitter and the receiver circuitry, and reducing common mode noise and EMI.

This transformer is recommended for use with the Cirrus Logic CS8401, CS8402, CS8403 and CS8404 "Digital Audio Interface Transmit Device."

The schematic below represents an implementation of transmit and receive circuits using isolation transformers at both ends. Equalization in the receiver may permit to increase the length of the interconnecting cable.

Applicable Documents

AES 3-1985 (ANSI S4.40-1985), AES 3-199XDraft, IEC 958, CP-340, EBU 3250

Application Circuit

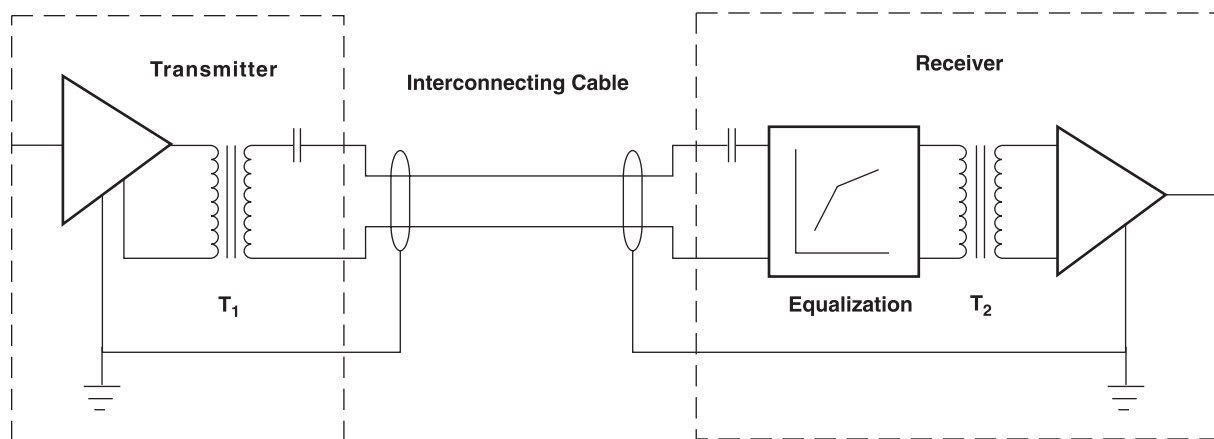

T₁, T₂: PE-65612NL

For More Information

Pulse Worldwide Headquarters
12220 World Trade Drive
San Diego, CA 92128
U.S.A.

Pulse Europe
Zeppelinstrasse 15
71083 Herrenberg
Germany

Pulse China Headquarters
B402, Shenzhen Academy of
Aerospace Technology Bldg.
10th Kejinan Road
High-Tech Zone
Nanshan District
Shenzhen, PR China 518057
Tel: 86 755 33966678
Fax: 86 755 33966700

Pulse North China
Room 2704/2705
Super Ocean Finance Ctr.
2067 Yan An Road West
Shanghai 200336
China

Tel: 86 21 62787060
Fax: 86 21 62786973

Pulse South Asia
135 Joo Seng Road
#03-02
PM Industrial Bldg.
Singapore 368363

Tel: 65 6287 8998
Fax: 65 6287 8998

Pulse North Asia
3F No. 198, Zhongyuan Road
Zhongli City
Taoyuan County (32068)
Taiwan

Tel: 886 3 4356768
Fax: 886 3 4356823

Performance warranty of products offered on this data sheet is limited to the parameters specified. Data is subject to change without notice. Other brand and product names mentioned herein may be trademarks or registered trademarks of their respective owners. © Copyright, 2013. Pulse Electronics, Inc. All rights reserved.