

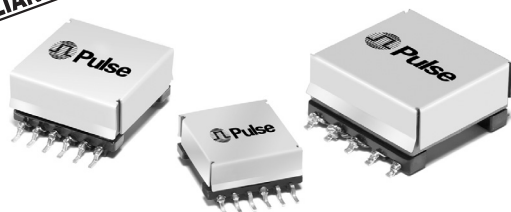





HIGH FREQUENCY WIRE WOUND TRANSFORMERS

EFD Platforms - EFD15, EFD20 and EFD25



-  Transformers and Inductors
-  **Power: 30W to 180W**
-  **Three Different Platforms: THT and SMT**
-  **Low Profile Platforms: 8.4mm to 13.5mm**
-  Custom designs available

Electrical Specifications @ 25°C — Operating Temperature -40°C to 125°C

TRANSFORMERS											
Part ^{6,7} Number	Application ²	Turns Ratio			Primary Secondary Isolation	Primary Inductance (μH MIN)	Leakage Inductance (μH MAX)	DCR (mΩ MAX)			
		Pri.	Sec.	Pri. Aux.				Pri.	Pri. Aux.	Sec. A	Sec. B
EFD 15 PLATFORMS - UP TO 30W											
EFD 15 - 10 PIN SMT - (21.6MM x 16.3MM x 8.4MM)											
PB2187NL	15W Flyback Transformer Vin=36-75v, Freq.=225kHz Vout=12v/1.7A, 15v/20mA	24	12	16	1500Vrms Operational	38 @ 2.2A	0.6	190	410	50	N/A
EFD 15 - 12 PIN SMT - (22.2MM x 17.2MM x 8.4MM)											
PA0476NL	15W Flyback Transformer Vin=18-72v, Freq.=500kHz Vout=5v/3A, 10v/20mA	16	3	7	500Vrms Operational	35.5	0.15	23.5	87	8	N/A
PA0691NL	15W Flyback Transformer Vin=30-57v, Freq.=100kHz Vout=3.3v/3A, 5.6v/10mA10v/20mA	52	8 & 14	26	500Vdc Operational	146 @ 1.2A	2.4	600	2000	20 (3.3v)	720 (5.6v)
PA1039NL	15W Flyback Transformer Vin=29-59v, Freq.=100kHz Vout=5v/2A, 7.5v/10mA10v/20mA	50	10 & 15	22	500Vdc Operational	137.5 @ 1.2A	2.0	500	1300	25	760
PA1067NL	20W Forward Transformer Vin=34-75v, Freq.=555kHz Vout=3.3v/6A, 12v/25mA	12	3	10 & 12 (reset)	500Vrms	79	1	70	70 & 70 (reset)	6	N/A
EFD 20 PLATFORMS - UP TO 80W											
EFD 20 - 8 PIN THT - (21.0MM x 21.0MM x 13.0MM)											
PA1040NL	80W Forward Transformer Vin=30-57v, Freq.=250kHz Vout=12v/5A, -12v/1.6A, 12v/0.1A	14	7 & 7	7	1500Vdc Operational	154	2	45	80	15	24
EFD 20 - 10 PIN SMT - (26.2MM x 21.8MM x 10.4MM)											
PB2003NL	30W Flyback Transformer Vin=36-72v, Freq.=300kHz Vout=5v/6A, 15v/0.1A	16	2	7	1500Vrms Operational	29.2 @ 3.0A	1.7	75	75	4.5	N/A
EFD 20 - 12 PIN SMT - (29.2MM x 21.8MM x 11.4MM)											
PA0273NL	50W Forward Transformer Vin=36-72v, Freq.=250kHz Vout=12v/4.5A, 12v/0.1A	16	10	10	1500Vrms Basic	230	0.35	65	240	27	N/A
PA0751NL	13W Flyback Transformer Vin=25-75v, Freq.=250kHz Vout=3.3v/4.5A, 15v/0.1A	26	6	18	700Vdc Operational	99	2	85	300	12	N/A
PA0769NL	100W Forward Transformer Vin=36-75v, Freq.=250kHz Vout=±12v/2.1A, 5v/9A	15	7 & 7 & 3	5	1500Vdc Operational	74	1.5	50	110	35 & 35 (±12v)	3.8 (5v)
PA1066NL	45W Forward Transformer Vin=30-75v, Freq.=550kHz Vout=±5v/4.5A, 12v/20mA	11	4 & 4	9 & 11 (reset)	500Vrms	93	1	35	100	15 & 15	N/A
PB2041NL	48W Forward Transformer Vin=36-75v, Freq.=230kHz Vout=12v/3A, -12v/1A	10 + 10	12 & 12	N/A	1500Vrms Basic	324	1	82	N/A	30.8 (+12v)	86.4 (-12v Sec)
PB2089NL	33W Forward Transformer Vin=36-72v, Freq.=250kHz Vout=3.3v/10A, 2.2v/0.05A	13	3 & 2	13 (reset)	1500Vrms Basic	141	1	31	923	5.5 (3.3v Sec)	112 (2.2v Sec)
PB2134NL	12W Flyback Transformer Vin=36-57v, Freq.=200kHz Vout=3.3v/3.5A, 12v/0.1A	32	4	15	1800Vdc Operational	195 @ 1.0A	5	200	215	12	N/A

(Transformers continued on next page)

HIGH FREQUENCY WIRE WOUND TRANSFORMERS

EFD Platforms - EFD15, EFD20 and EFD25



Electrical Specifications @ 25°C — Operating Temperature -40°C to 125°C

TRANSFORMERS (continued)											
Part ^{6,7} Number	Application ²	Turns Ratio			Primary Secondary Isolation	Primary Inductance (μH MIN)	Leakage Inductance (μH MAX)	DCR (mΩ MAX)			
		Pri.	Sec.	Pri. Aux.				Pri.	Pri. Aux.	Sec. A	Sec. B
EFD 25 PLATFORMS - UP TO 180W											
EFD 25 - 10 PIN THT - (26.4MM x 26.1MM x 14.0MM)											
PA0397NL	100W Forward Transformer Vin=36-75v, Freq.=250kHz Vout=3.3v/30A, 12v/0.1A	9	2	8	1500Vdc Basic	113	0.64	21	570	3.3	N/A
EFD 25 - 10 PIN SMT - (32.0MM x 26.2MM x 13.5MM)											
PA0302NL	165 F-Bridge Transformer Vin=21-56v, Freq.=230kHz Vout=15v/11A	1	1	1	500Vrms Operational	24	0.1	8	130	8	8
EFD 25 - 12 PIN SMT - (32.0MM x 26.2MM x 13.7MM)											
PA0700NL	72W Forward Transformer Vin=12v, Freq.=250kHz Vout=48v/1.5A	3	22	N/A	2250Vrms Operational	21.4	0.5	4	N/A	95	N/A
INDUCTORS											
Part ^{6,7} Number	Application ²	Induct. @ Irated (μH MIN)	Irated (Adc)	Turns Ratio	DCR (mΩ MAX)			Induct. 0 Adc ³ (μH ±7%)	Saturation Current ⁴ @25°	Heating Current ⁵ (A)	±12V Winding to Aux. Isolation
					Winding 1	Winding 2	Winding 3				
EFD 20 PLATFORMS											
EFD 20 - 12 PIN SMT - (29.2MM x 21.8MM x 11.4MM)											
PB2042NL	Output Inductor for PB2041 Transformer	13	4	3:3:4 (+12v:-12v:Aux)	29.2 (+12v)	87.6 (+12v)	253 (15v Aux.)	14.4	5	4	1500 Vrms Basic

Notes:

- The temperature of the component (ambient plus temperature rise) must be within the stated operating temperature range.
- The above transformers and inductors have been tested and approved by Pulse's power IC partners and are sited in the appropriate datasheet or evaluation board documentation at these companies. To determine which IC and IC partners are matched with the above Pulse part numbers please consult the IC Cross Reference on the Pulse website.
- The rated current as listed is either 85% of the saturation current or the heating current whichever is lower.
- The saturation current is the current which causes the inductance to drop by 20% at 25°C. This current is determined by placing the component in the specified ambient environment and applying a short duration pulse current (to eliminate self-heating effects) to the component.
- The heating current is the dc current which causes the temperature of the part to increase by approximately 40°C.
- Add 'T' suffix to the part number for Tape & Reel version (ie: PB2041NLT).
- The "NL" suffix indicates an RoHS-compliant part number. Non-NL suffixed parts are not necessarily RoHS compliant, but are electrically and mechanically equivalent to NL versions. If a part number does not have the "NL" suffix, but an RoHS compliant version is required, please contact Pulse for availability.

Mechanicals

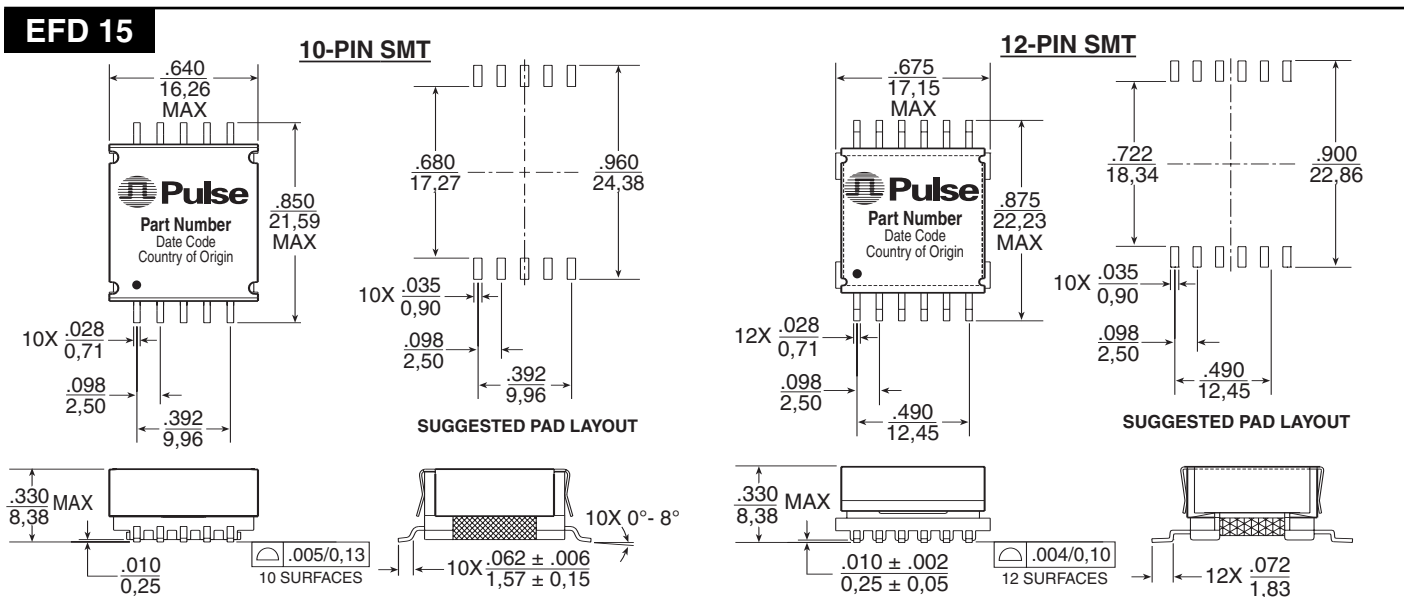

USA 858 674 8100 • Germany 49 7032 7806 0 • Singapore 65 6287 8998 • Shanghai 86 21 54643211 / 2 • China 86 755 33966678 • Taiwan 886 3 4641811

HIGH FREQUENCY WIRE WOUND TRANSFORMERS

EFD Platforms - EFD15, EFD20 and EFD25



Mechanicals

EFD 20

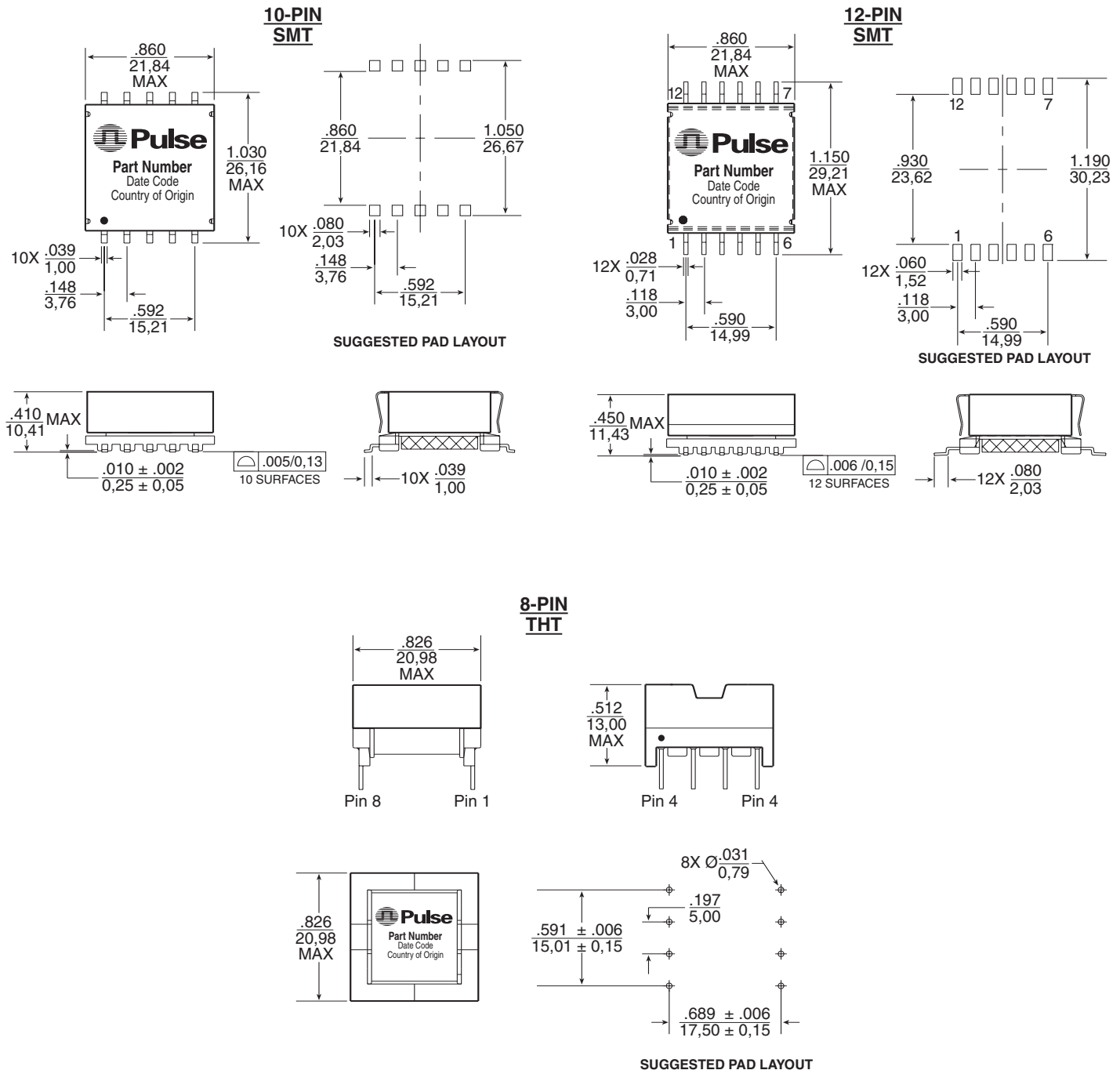

HIGH FREQUENCY WIRE WOUND TRANSFORMERS

EFD Platforms - EFD15, EFD20 and EFD25



Mechanicals

EFD 25

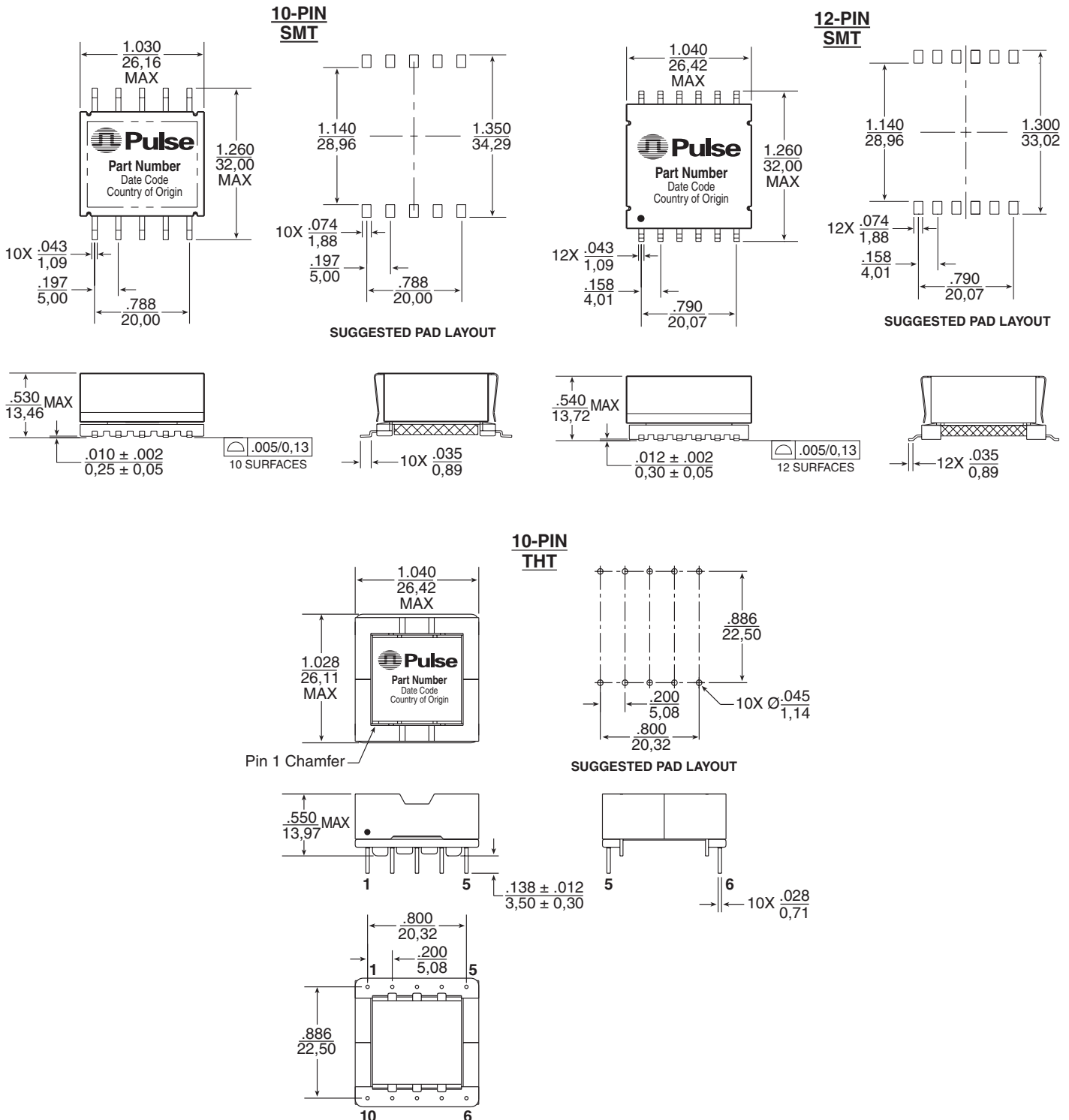

HIGH FREQUENCY WIRE WOUND TRANSFORMERS

EFD Platforms - EFD15, EFD20 and EFD25



Schematics

EFD 15

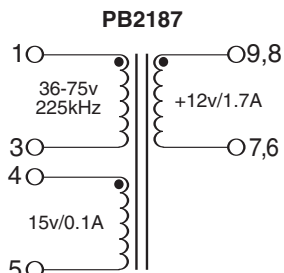

NOTE: Pins 9 to 8 and Pins 7 to 6 to be connected on customer PCB

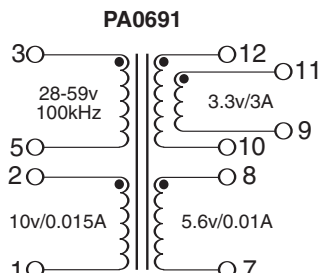
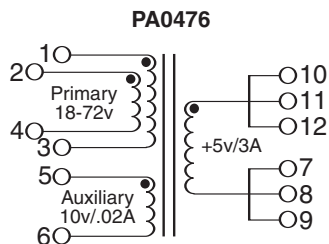

NOTE: Pins 8, 9 and 10 to be connected on customer PCB

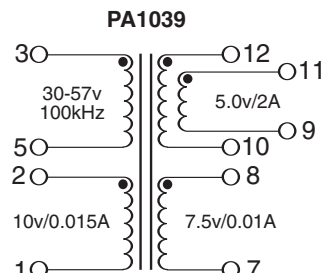

NOTE: Pins 8, 9 and 10 to be connected on customer PCB

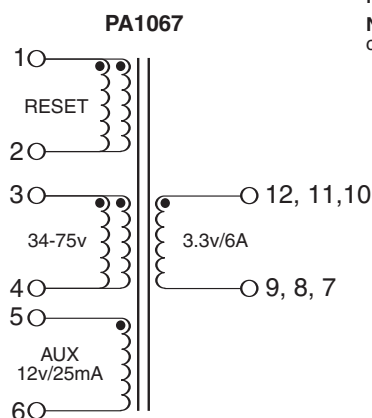

EFD 20

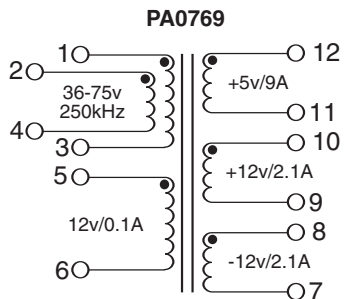
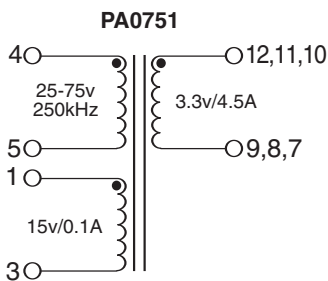
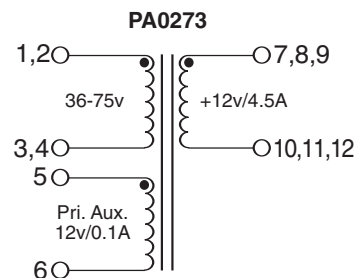
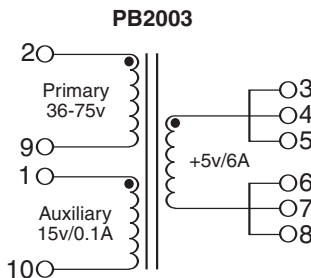
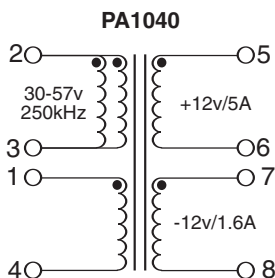

NOTE: Pins 1 & 2 and Pins 3 & 4 to be connected on customer PCB

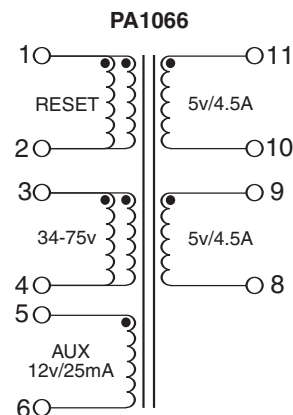

(EFD 20 Schematics continued on next page)

HIGH FREQUENCY WIRE WOUND TRANSFORMERS

EFD Platforms - EFD15, EFD20 and EFD25



Schematics

EFD 20 (continued)

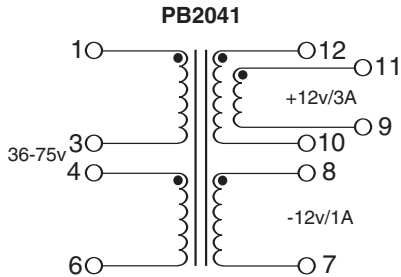

NOTE: Pins 12 & 11, Pins 9 & 10, and Pins 3 & 4 to be connected on customer PCB

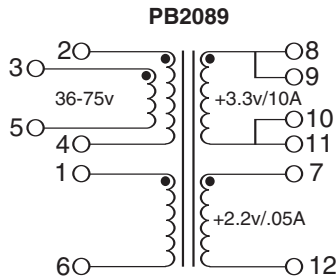

NOTE: Pins 2 & 3 and Pins 4 & 5 to be connected on customer PCB

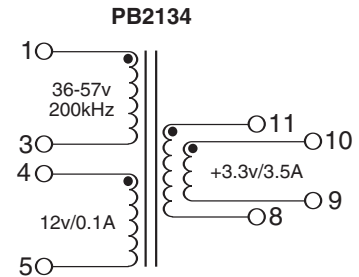

NOTE: Pins 10 & 11, Pins 8 & 9 to be connected on customer PCB

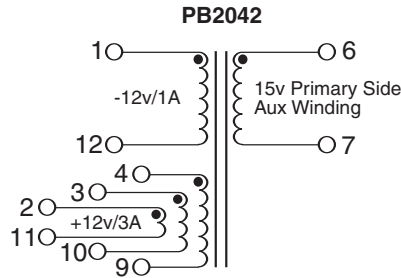
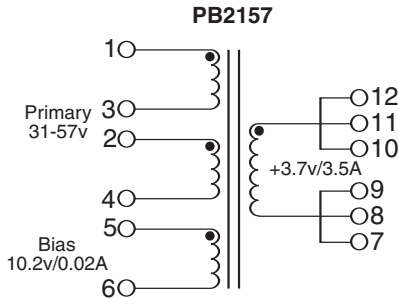

NOTE: Pins 2, 3 & 4 and Pins 9, 10 & 11 to be connected on customer PCB

EFD 25

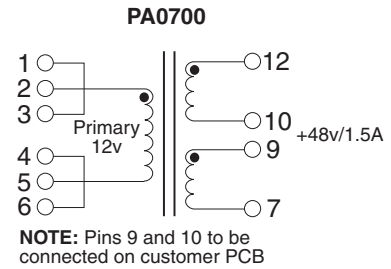
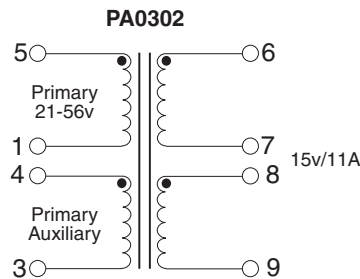
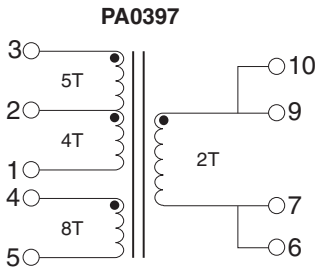

NOTE: Pins 9 and 10 to be connected on customer PCB