

NGD18N45CLB - 18 A, 450 V, N-Channel Ignition IGBT, DPAK

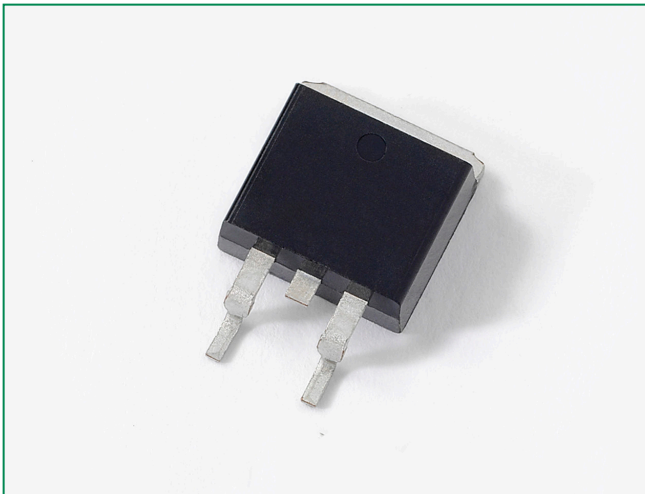

18 Amps, 450 Volts
 $V_{CE(on)} \leq 2.1 V @$
 $I_C = 10 A, V_{GE} \geq 4.5 V$

Maximum Ratings ($T_J = 25^\circ C$ unless otherwise noted)

| Rating | Symbol | Value | Unit |
|---|----------------|----------------|----------------------|
| Collector–Emitter Voltage | V_{CES} | 500 | V_{DC} |
| Gate–Gate Voltage | V_{CER} | 500 | V_{DC} |
| Gate–Emitter Voltage | V_{GE} | 18 | V_{DC} |
| Collector Current–Continuous @ $T_C = 25^\circ C$ – Pulsed | I_C | 18 50 | A_{DC} A_{AC} |
| ESD (Human Body Model) $R = 1500 \Omega, C = 100 pF$ | ESD | 8.0 | kV |
| ESD (Machine Model) $R = 0 \Omega, C = 200 pF$ | ESD | 400 | V |
| Total Power Dissipation @ $T_C = 25^\circ C$ Derate above $25^\circ C$ | P_D | 115 0.77 | W W/ $^\circ C$ |
| Operating and Storage Temperature Range | T_J, T_{stg} | -55 to +175 | $^\circ C$ |

Stresses exceeding Maximum Ratings may damage the device. Maximum Ratings are stress ratings only. Functional operation above the Recommended Operating Conditions is not implied. Extended exposure to stresses above the Recommended Operating Conditions may affect device reliability.

Description

This Logic Level Insulated Gate Bipolar Transistor (IGBT) features monolithic circuitry integrating ESD and Over-Voltage clamped protection for use in inductive coil drivers applications. Primary uses include Ignition, Direct Fuel Injection, or wherever high voltage and high current switching is required.

Features

- Ideal for Coil-on-Plug Applications
- DPAK Package Offers Smaller Footprint for Increased Board Space
- Gate–Emitter ESD Protection
- Temperature Compensated Gate–Collector Voltage Clamp Limits Stress Applied to Load
- Low Threshold Voltage Interfaces Power Loads to Logic or Microprocessor Devices
- Low Saturation Voltage
- High Pulsed Current Capability
- Emitter Ballasting for Short–Circuit Capability
- This is a Pb–Free Device

Functional Diagram

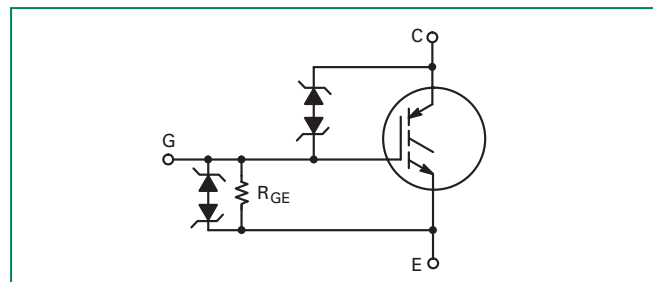

Additional Information



Datasheet



Resources



Samples

Unclamped Collector–To–Emitter Avalanche Characteristics (Note 2)

| | Symbol | Value | Unit |
|---|----------|-------|------|
| Single Pulse Collector–to–Emitter Avalanche Energy | | | |
| $V_{CC} = 50\text{ V}, V_{GE} = 5.0\text{ V}, P_k I_L = 26.0\text{ A}, R_G = 1000\ \Omega, L = 1.0\text{ mH}, \text{Starting } T_J = 25^\circ\text{C}$ | E_{AS} | 338 | mJ |
| $V_{CC} = 50\text{ V}, V_{GE} = 5.0\text{ V}, P_k I_L = 10.0\text{ A}, R_G = 1000\ \Omega, L = 8.4\text{ mH}, \text{Starting } T_J = 25^\circ\text{C}$ | | 420 | |
| $V_{CC} = 50\text{ V}, V_{GE} = 5.0\text{ V}, P_k I_L = 15.4\text{ A}, R_G = 1000\ \Omega, L = 2.0\text{ mH}, \text{Starting } T_J = 150^\circ\text{C}$ | | 237 | |
| $V_{CC} = 50\text{ V}, V_{GE} = 5.0\text{ V}, P_k I_L = 5.7\text{ A}, R_G = 1000\ \Omega, L = 15.2\text{ mH}, \text{Starting } T_J = 150^\circ\text{C}$ | | 247 | |

Thermal Characteristics

| | Symbol | Value | Unit |
|---|-----------------|-------|------|
| Thermal Resistance, Junction to Case | $R_{\theta JC}$ | 1.3 | °C/W |
| Thermal Resistance, Junction to Ambient DPAK (Note 1) | $R_{\theta JA}$ | 95 | |
| Maximum Lead Temperature for Soldering Purposes, 1/8" from case for 5 seconds | T_L | 275 | °C |

Maximum Short-Circuit Times

| Rating | Symbol | Value | Unit |
|--|-------------|-------|---------------|
| Short Circuit Withstand Time – Test 1 (See Figure 17, 3 Pulses with 10 ms Period, $T_a = 105^\circ\text{C}$) | t_{sc1-1} | 1000 | μS |
| Short Circuit Withstand Time – Test 1 (See Figure 17, 3 Pulses with 10 ms Period, $T_a = 150^\circ\text{C}$) | t_{sc1-2} | 800 | μS |
| Short Circuit Withstand Time – Test 2 (See Figure 18, 3 Pulses with 10 ms Period, $T_a = 105^\circ\text{C}$) | t_{sc2-1} | 5 | ms |
| Short Circuit Withstand Time – Test 2 (See Figure 18, 3 Pulses with 10 ms Period, $T_a = 150^\circ\text{C}$) | t_{sc2-2} | 1 | ms |

Electrical Characteristics - OFF (Note 2)

| Characteristic | Symbol | Test Conditions | Temperature | Min | Typ | Max | Unit |
|---|---------------|--|---|-----|-----|-----|--------------|
| Collector–Emitter Clamp Voltage | BV_{CES} | $I_C = 2.0 \text{ mA}$ | $T_J = -40^\circ\text{C to } 150^\circ\text{C}$ | 430 | 455 | 470 | V_{DC} |
| | | $I_C = 10 \text{ mA}$ | $T_J = -40^\circ\text{C to } 150^\circ\text{C}$ | 440 | 475 | 500 | |
| Zero Gate Voltage Collector Current | $iECS$ | $V_{CE} = 350 \text{ V}$ $V_{GE} = 0 \text{ V}$ | $T_J = 25^\circ\text{C}$ | – | 0.5 | 20 | μA_{DC} |
| | | | $T_J = 150^\circ\text{C}$ | – | 75 | 250 | |
| | | | $T_J = -40^\circ\text{C}$ | – | 0.2 | 10 | |
| | | $V_{CE} = 15 \text{ V}$ $V_{GE} = 0 \text{ V}$ | $T_J = 25^\circ\text{C}$ | – | – | 2.0 | |
| Reverse Collector–Emitter Leakage Current | I_{CES} | $V_{CE} = -24 \text{ V}$ | $T_J = 25^\circ\text{C}$ | – | 0.7 | 1.0 | mA |
| | | | $T_J = 150^\circ\text{C}$ | – | 12 | 25 | |
| | | | $T_J = -40^\circ\text{C}$ | – | 0.1 | 1.0 | |
| Reverse Collector–Emitter Clamp Voltage | $BV_{CES(R)}$ | $I_C = -75 \text{ mA}$ | $T_J = 25^\circ\text{C}$ | 24 | 27 | 30 | V_{DC} |
| | | | $T_J = 150^\circ\text{C}$ | 26 | 29 | 33 | |
| | | | $T_J = -40^\circ\text{C}$ | 23 | 26 | 29 | |
| Gate–Emitter Clamp Voltage | BV_{GES} | $I_G = 5.0 \text{ mA}$ | $T_J = -40^\circ\text{C to } 150^\circ\text{C}$ | 11 | 13 | 15 | V_{DC} |
| Gate–Emitter Leakage Current | I_{GES} | $V_{GE} = \pm 10 \text{ V}$ | $T_J = -40^\circ\text{C to } 150^\circ\text{C}$ | 384 | 590 | 700 | μA_{DC} |
| Gate-Emitter Resistor | R_{GE} | – | $T_J = -40^\circ\text{C to } 150^\circ\text{C}$ | 10 | 16 | 26 | k Ω |

1. When surface mounted to an FR4 board using the minimum recommended pad size.

Electrical Characteristics - ON (Note 2)

| Characteristic | Symbol | Test Conditions | Temperature | Min | Typ | Max | Unit |
|--|--------------|---|---|------|------|------|----------|
| Gate Threshold Voltage | $V_{GE(th)}$ | $I_C = 1.0\text{ mA}$, $V_{GE} = V_{CE}$ | $T_J = 25^\circ\text{C}$ | 1.1 | 1.56 | 1.9 | V_{DC} |
| | | | $T_J = 150^\circ\text{C}$ | 0.75 | 1.08 | 1.4 | |
| | | | $T_J = -40^\circ\text{C}$ | 1.2 | 1.75 | 2.1 | |
| Threshold Temperature Coefficient (Negative) | - | - | - | - | 3.5 | - | mV/°C |
| Collector-to-Emitter On-Voltage | $V_{CE(on)}$ | $V_{CE} = 4.5\text{ V}$, $I_C = 7\text{ A}$ | $T_J = -40^\circ\text{C to } 150^\circ\text{C}$ | 1.10 | 1.84 | 2.30 | V_{DC} |
| | | | $T_J = -40^\circ\text{C to } 150^\circ\text{C}$ | 1.15 | 1.89 | 2.35 | |
| | | | $T_J = -40^\circ\text{C to } 150^\circ\text{C}$ | 1.20 | 1.93 | 2.50 | |
| | | | $T_J = -40^\circ\text{C to } 150^\circ\text{C}$ | 1.45 | 2.07 | 2.65 | |
| | | | $T_J = -40^\circ\text{C to } 150^\circ\text{C}$ | 1.50 | 2.13 | 2.80 | |
| | | | $T_J = -40^\circ\text{C to } 150^\circ\text{C}$ | 1.55 | 2.19 | 2.85 | |
| | | | $T_J = -40^\circ\text{C to } 150^\circ\text{C}$ | - | 0.65 | 1.00 | |
| Forward Transconductance | gfs | $V_{CE} = 5.0\text{ V}$, $I_C = 6.0\text{ A}$ | $T_J = -40^\circ\text{C to } 150^\circ\text{C}$ | 6.0 | 14 | 25 | Mhos |

Dynamic Characteristics

| Characteristic | Symbol | Test Conditions | Temperature | Min | Typ | Max | Unit |
|----------------------|-----------|---|--|-----|-----|------|------|
| Input Capacitance | C_{ISS} | $V_{CC} = 25\text{ V}$ $V_{GE} = 0\text{ V}$ $f = 1.0\text{ MHz}$ | $T_J = -40^\circ\text{C}$ to 150°C | 400 | 780 | 1000 | pF |
| Output Capacitance | C_{OSS} | | | 50 | 72 | 100 | |
| Transfer Capacitance | C_{RSS} | | | 4.0 | 6 | 10 | |

Switching Characteristics (Note 2)

| Characteristic | Symbol | Test Conditions | Temperature | Min | Typ | Max | Unit |
|---------------------|--------------|--|--------------------------|-----|------|-----|------|
| Turn-Off Delay Time | $t_{d(off)}$ | $V_{CC} = 300\text{ V}$ $V_{GE} = 0\text{ V}$ $R_G = 1.0\text{ k}\Omega$ $R_L = 46\ \Omega$ | $T_J = 25^\circ\text{C}$ | 1.0 | 2.9 | 12 | μSec |
| Fall Time | t_f | $V_{CC} = 300\text{ V}$ $V_{GE} = 5\text{ V}$ $R_G = 1.0\text{ k}\Omega$ $R_L = 46\ \Omega$ | $T_J = 25^\circ\text{C}$ | 1.0 | 2.5 | 7.0 | |
| Turn-On Delay Time | $t_{d(on)}$ | $V_{CC} = 14\text{ V}$ $V_{GE} = 5\text{ V}$ $R_G = 1.0\text{ k}\Omega$ $R_L = 1\ \Omega$ | $T_J = 25^\circ\text{C}$ | 0.1 | 0.42 | 1.4 | |
| Rise Time | t_r | $V_{CC} = 14\text{ V}$ $V_{GE} = 5\text{ V}$ $R_G = 1.0\text{ k}\Omega$ $R_L = 1\ \Omega$ | $T_J = 25^\circ\text{C}$ | 1.0 | 2.5 | 9.0 | |

2. Electrical Characteristics at temperature other than 25°C, Dynamic and Switching characteristics are not subject to production testing. Product parametric performance is indicated in the Electrical Characteristics for the listed test conditions, unless otherwise noted. Product performance may not be indicated by the Electrical Characteristics if operated under different conditions.

Typical Electrical Characteristics (unless otherwise noted)

Figure 1. Output Characteristics

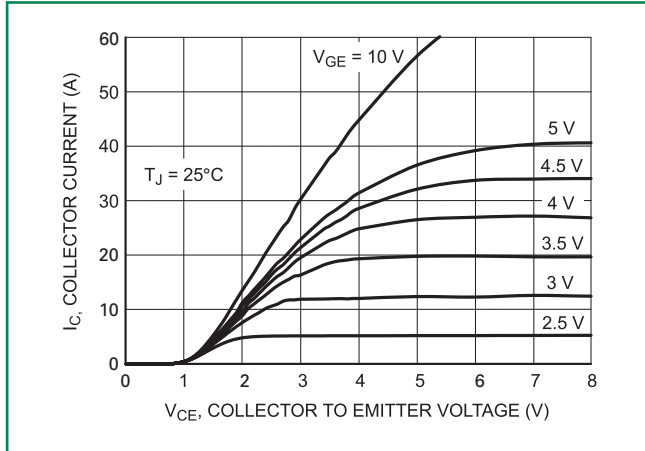

Figure 2. Output Characteristics

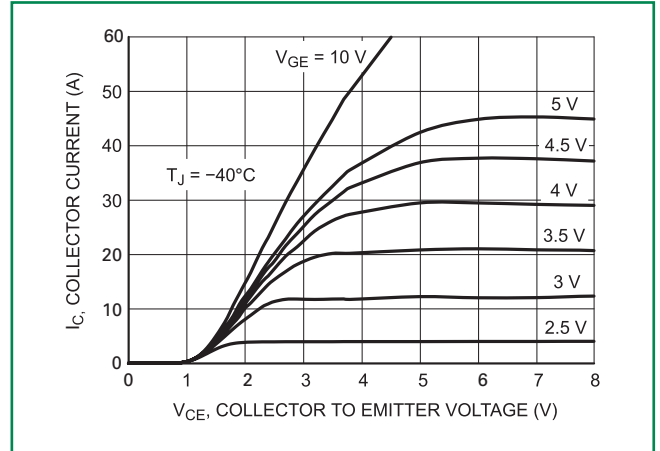

Figure 3. Output Characteristics

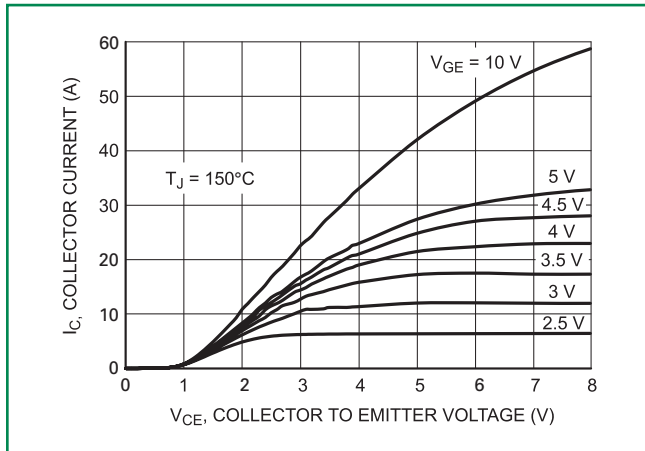

Figure 4. Transfer Characteristics

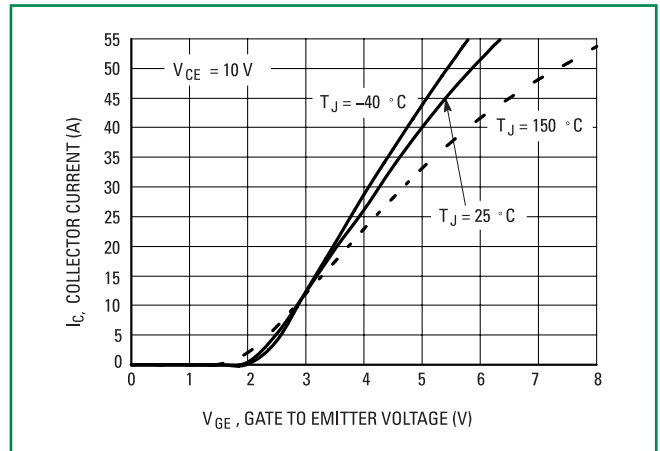

Figure 5. Collector-to-Emitter Saturation Voltage vs. Junction Temp

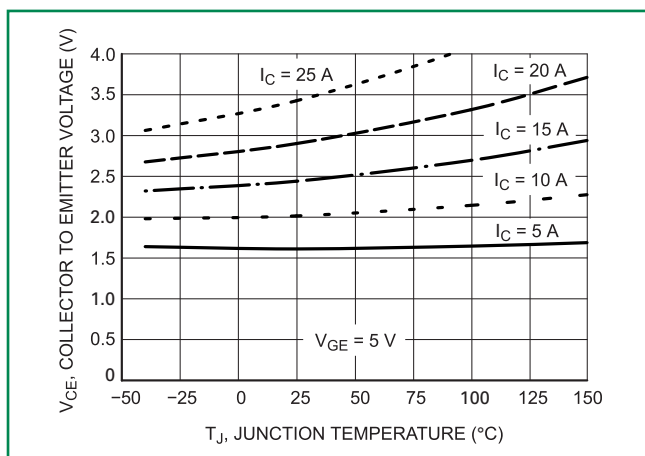

Figure 6. Collector-to-Emitter Voltage versus Gate-to-Emitter

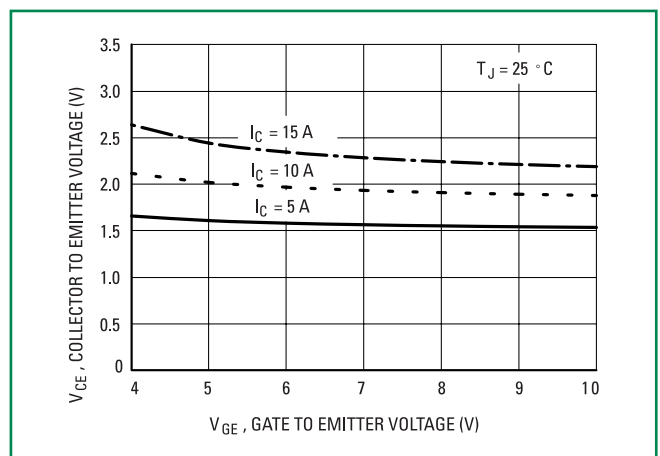

Figure 7. Collector-to-Emitter Voltage vs Gate-to-Emitter Voltage

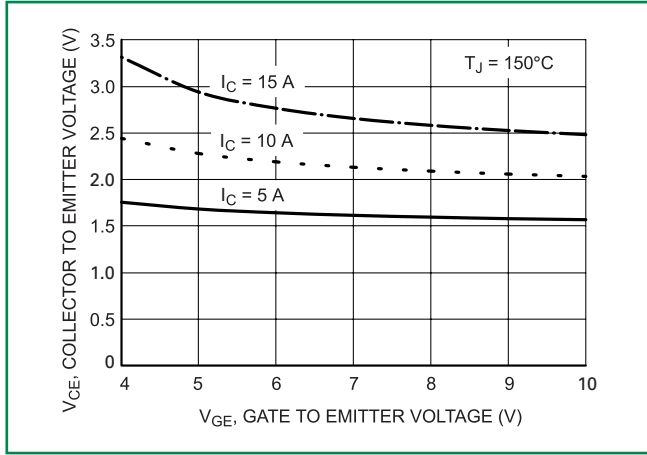

Figure 8. Capacitance Variation

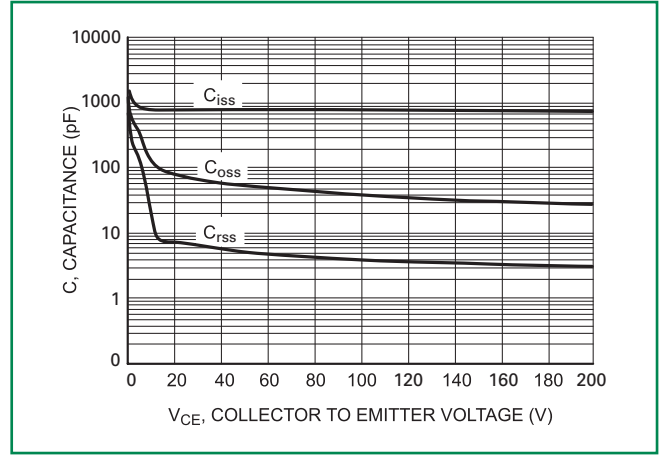

Figure 9. Gate Threshold Voltage vs. Junction Temperature

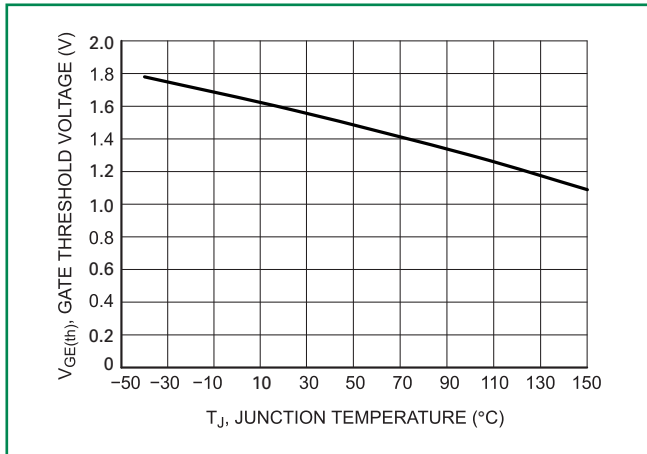

Figure 10. Minimum Open Secondary Latch Current vs. Inductance

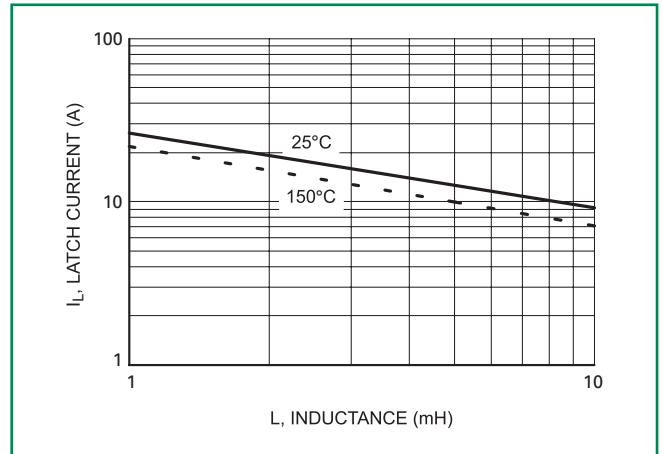

Figure 11. Typical Open Secondary Latch Current vs. Inductance

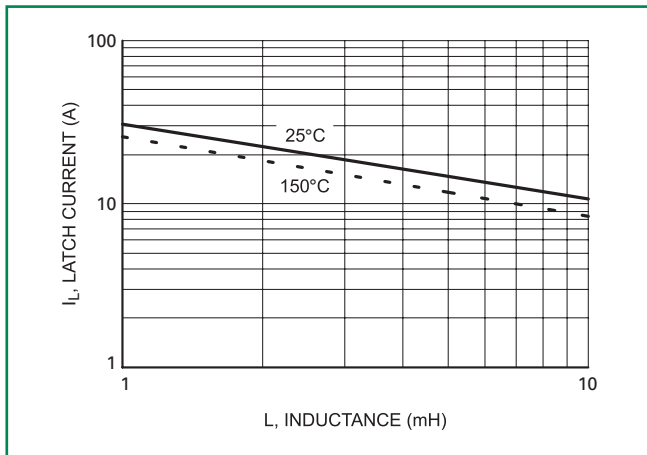

Figure 12. Inductive Switching Fall Time vs. Temperature

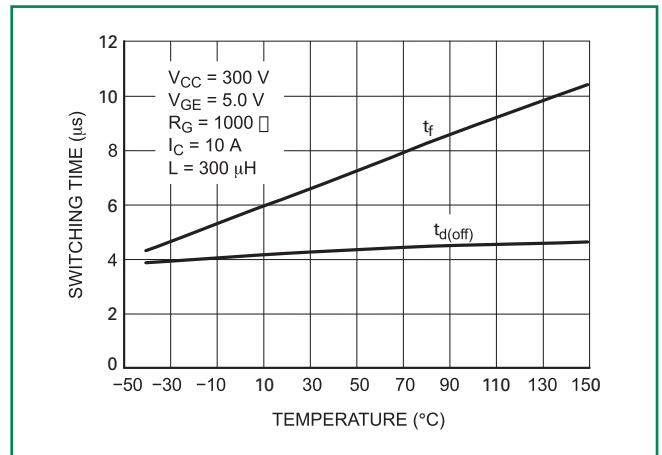

Figure 13. Single Pulse Safe Operating Area
 (Mounted on an Infinite Heatsink at $T_A = 25^\circ\text{C}$)

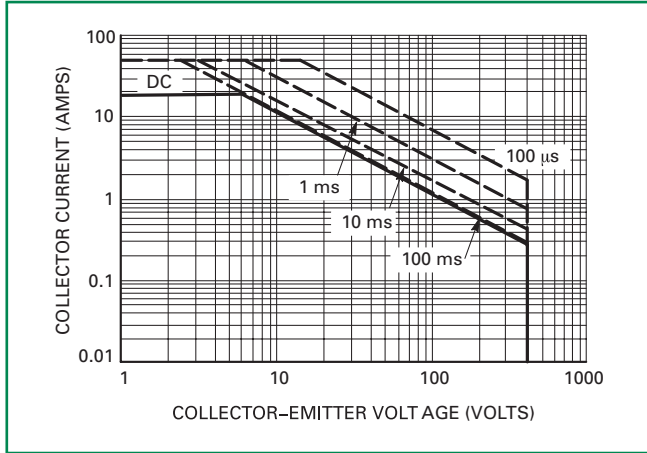

Figure 14. Single Pulse Safe Operating Area
 (Mounted on an Infinite Heatsink at $T_A = 125^\circ\text{C}$)

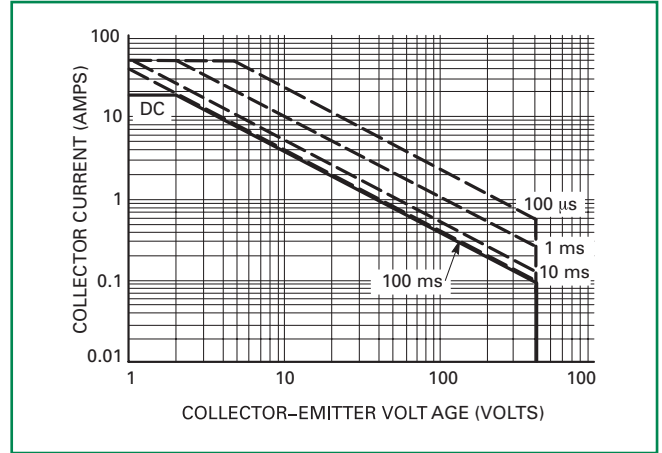

Figure 15. Pulse Train Safe Operating Area
 (Mounted on an Infinite Heatsink at $T_C = 25^\circ\text{C}$)

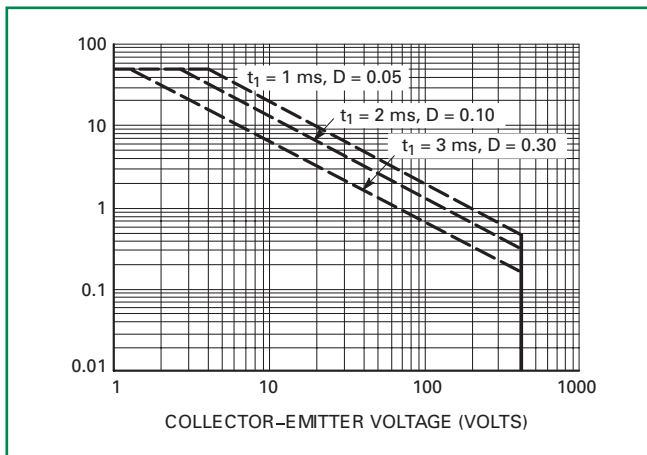

Figure 16. Pulse Train Safe Operating Area
 (Mounted on an Infinite Heatsink at $T_C = 25^\circ\text{C}$)

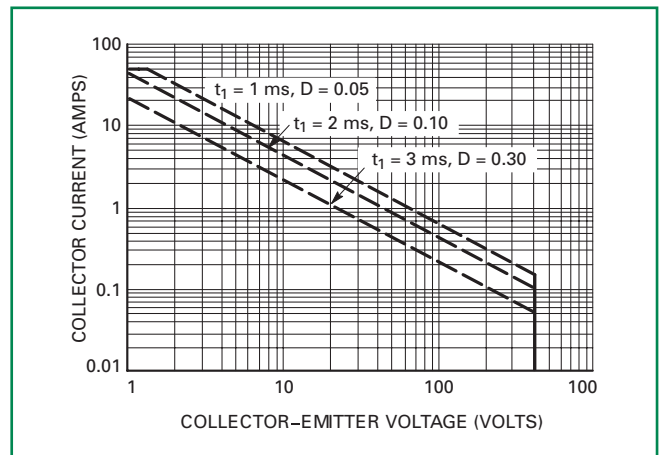

Figure 17. Circuit Configuration for Short Circuit Test #1

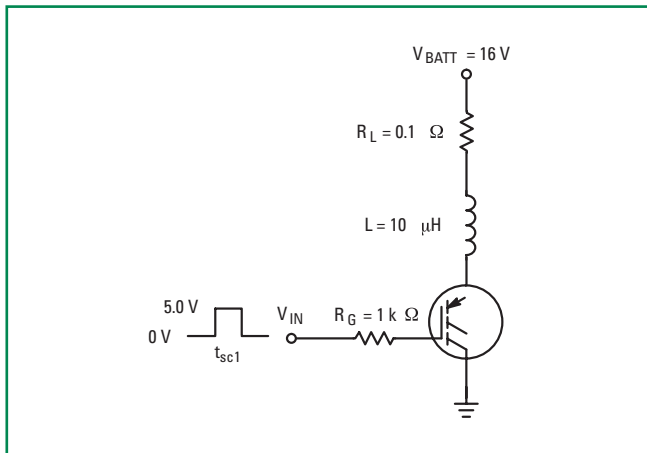

Figure 18. Circuit Configuration for Short Circuit Test #2

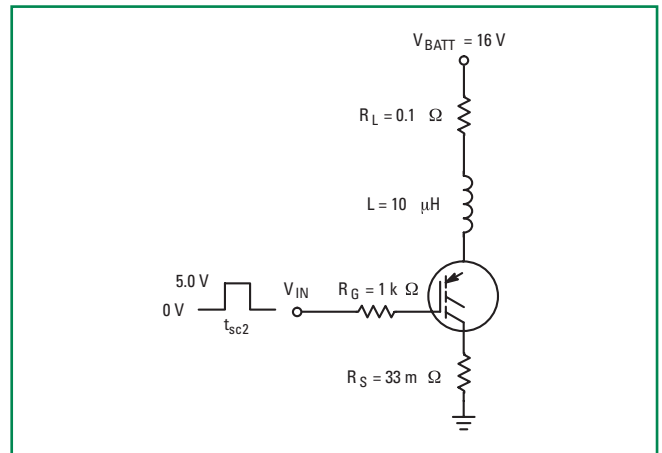
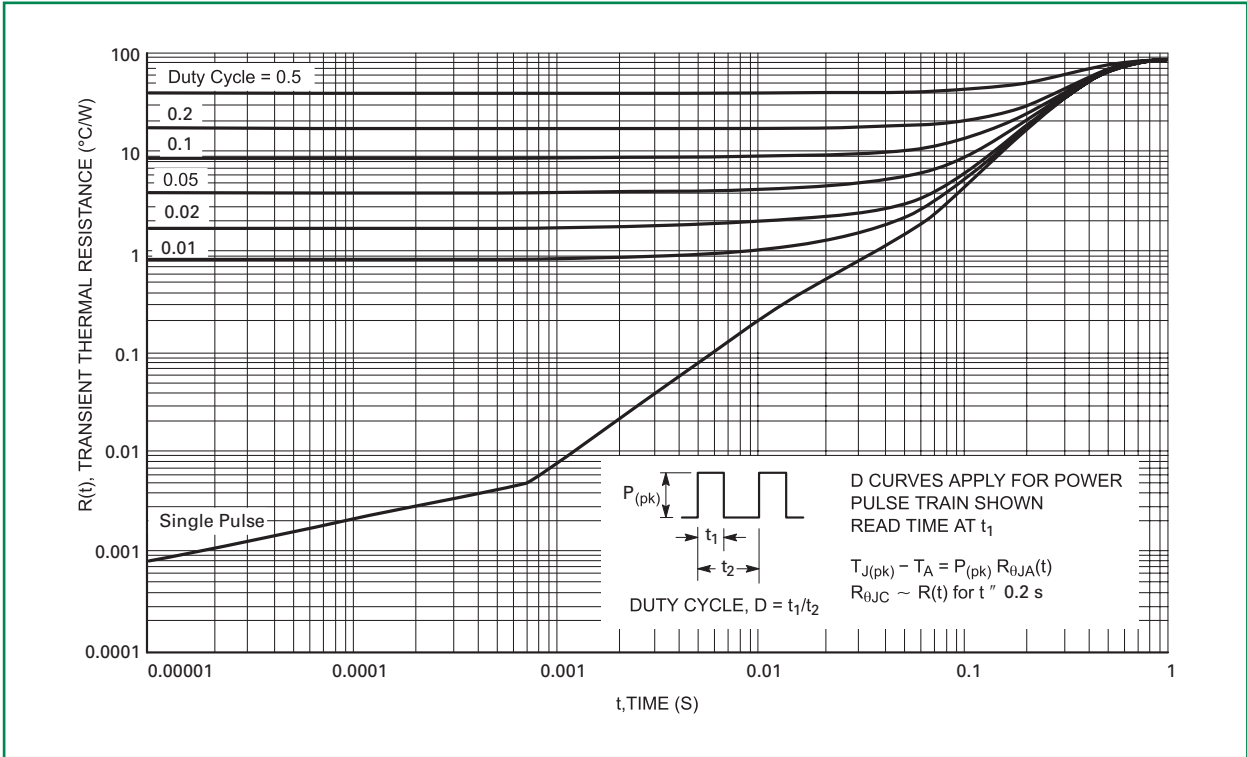
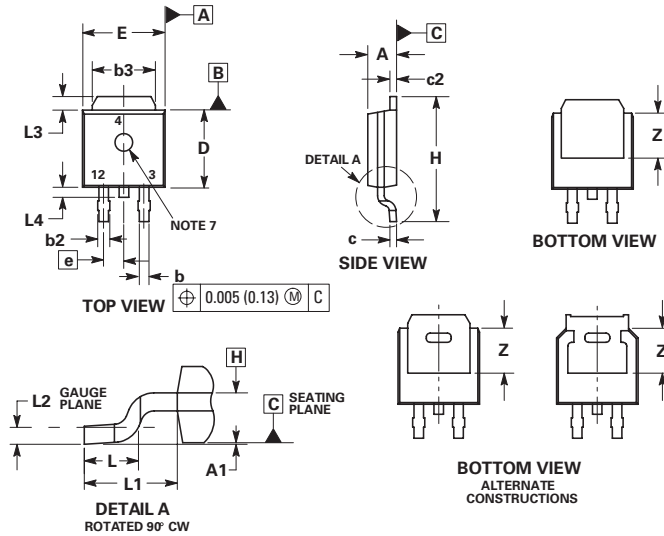

Figure 19. Transient Thermal Resistance (Non-normalized Junction-to-Ambient mounted on minimum pad area)



Dimensions



| Dim | Inches | | Millimeters | |
|-----|-----------|-------|-------------|-------|
| | Min | Max | Min | Max |
| A | 0.086 | 0.094 | 2.18 | 2.38 |
| A1 | 0.000 | 0.005 | 0.00 | 0.13 |
| b | 0.025 | 0.035 | 0.63 | 0.89 |
| b2 | 0.028 | 0.045 | 0.72 | 1.14 |
| b3 | 0.180 | 0.215 | 4.57 | 5.46 |
| c | 0.018 | 0.024 | 0.46 | 0.61 |
| c2 | 0.018 | 0.024 | 0.46 | 0.61 |
| D | 0.235 | 0.245 | 5.97 | 6.22 |
| E | 0.250 | 0.265 | 6.35 | 6.73 |
| e | 0.090 BSC | | 2.29 BSC | |
| H | 0.370 | 0.410 | 9.40 | 10.41 |
| L | 0.055 | 0.070 | 1.40 | 1.78 |
| L1 | 0.114 REF | | 2.90 REF | |
| L2 | 0.020 BSC | | 0.51 BSC | |
| L3 | 0.035 | 0.050 | 0.89 | 1.27 |
| L4 | --- | 0.040 | --- | 1.01 |
| Z | 0.155 | --- | 3.93 | --- |

NOTES:

1. DIMENSIONING AND TOLERANCING PER ASME Y14.5M, 1994.
2. CONTROLLING DIMENSION: INCH.
3. THERMAL PAD CONTOUR OPTIONAL WITHIN DIMENSIONS b3, L3 and Z.
4. DIMENSIONS D AND E DO NOT INCLUDE MOLD FLASH, PROTRUSIONS, OR BURRS. MOLD FLASH, PROTRUSIONS, OR GATE BURRS SHALL NOT EXCEED 0.006 INCHES PER SIDE.
5. DIMENSIONS D AND E ARE DETERMINED AT THE OUTERMOST EXTREMES OF THE PLASTIC BODY.
6. DATUMS A AND B ARE DETERMINED AT DATUM PLANE H.
7. OPTIONAL MOLD FEATURE

Soldering Footprint

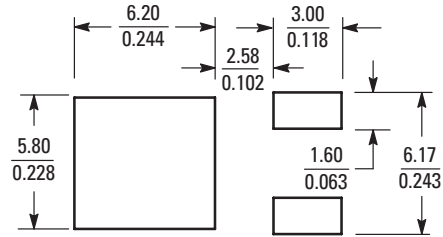

SCALE 3:1 (mm/inches)

Part Marking System

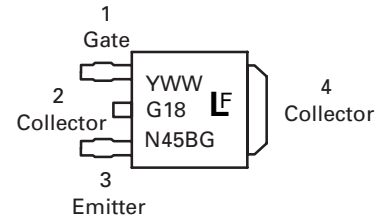

G18N45BG = Device Code

Y= Year
WW = Work Week
G = Pb-Free Device

ORDERING INFORMATION

| Device | Package | Shipping† |
|----------------|----------------|---------------------|
| NGD18N45CLBT4G | DPAK (Pb-Free) | 2,500 / Tape & Reel |

Disclaimer Notice - Information furnished is believed to be accurate and reliable. However, users should independently evaluate the suitability of and test each product selected for their own applications. Littelfuse products are not designed for, and may not be used in, all applications. Read complete Disclaimer Notice at: www.littelfuse.com/disclaimer-electronics.