

SYNCHRONOUS DRAM MODULE

MT8LSDT1664A – 128MB
MT16LSDT3264A – 256MB

For the latest data sheet, please refer to the Micron® Web site: www.micron.com/products/modules

Features

- 168-pin, dual in-line memory module (DIMM)
- PC100- and PC133-compliant
- Utilizes 125 MHz and 133 MHz SDRAM components
- Unbuffered
- 128MB (16 Meg x 64) and 256MB (32 Meg x 64)
- Single +3.3V power supply
- Fully synchronous; all signals registered on positive edge of system clock
- Internal pipelined operation; column address can be changed every clock cycle
- Internal SDRAM banks for hiding row access/precharge
- Programmable burst lengths: 1, 2, 4, 8, or full page
- Auto Precharge, includes CONCURRENT AUTO PRECHARGE and Auto Refresh Modes
- Self Refresh Mode: 64ms, 4,096-cycle refresh (15.625µs refresh interval)
- LVTTTL-compatible inputs and outputs
- Serial Presence-Detect (SPD)
- Gold edge contacts

Table 1: Timing Parameters

CL = CAS (READ) latency

MODULE MARKING	CLOCK FREQUENCY	ACCESS TIME		SETUP TIME	HOLD TIME
		CL = 2	CL = 3		
-13E	133 MHz	5.4ns	–	1.5	0.8
-133	133 MHz	–	5.4ns	1.5	0.8
-10E	100 MHz	9ns	7.5ns	2ns	1ns

Figure 1: 168-Pin DIMM (MO-161)

Standard 1.375in. (34.93mm)

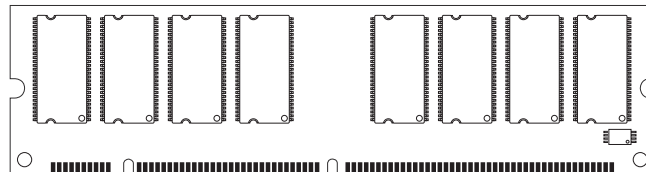

Low Profile 1.125in. (28.58mm)

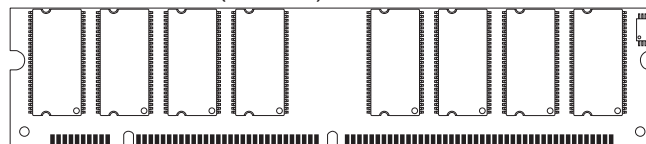

Options

Marking

- Frequency/CAS Latency
 - 133 MHz/CL = 2 -13E
 - 133 MHz/CL = 3 -133
 - 100 MHz/CL = 2 -10E
- PCB
 - Standard 1.375in. (34.93mm)
 - Low-Profile 1.125in. (28.58mm)¹

NOTE: 1. Contact Micron for product availability.

Table 2: Address Table

	128MB	256MB
Refresh Count	4K	4K
Device Banks	4 (BA0, BA1)	4 (BA0, BA1)
Device Configuration	128Mb (16 Meg x 8)	128Mb (16 Meg x 8)
Row Addressing	4K (A0–A11)	4K (A0–A11)
Column Addressing	1K (A0–A9)	1K (A0–A9)
Module Ranks	1 (S0#, S2#)	2 (S0#, S2#; S1#, S3#)



Table 3: Part Numbers

PART NUMBER	MODULE DENSITY	CONFIGURATION	SYSTEM BUS SPEED
MT8LSDT1664AG-13E_	128MB	16 Meg x 64	133 MHz
MT8LSDT1664AY-13E_	128MB	16 Meg x 64	133 MHz
MT8LSDT1664AG-133_	128MB	16 Meg x 64	133 MHz
MT8LSDT1664AY-133_	128MB	16 Meg x 64	133 MHz
MT8LSDT1664AG-10E_	128MB	16 Meg x 64	100 MHz
MT8LSDT1664AY-10E_	128MB	16 Meg x 64	100 MHz
MT16LSDT3264AG-13E_	256MB	32 Meg x 64	133 MHz
MT16LSDT3264AY-13E_	256MB	32 Meg x 64	133 MHz
MT16LSDT3264AG-133_	256MB	32 Meg x 64	133 MHz
MT16LSDT3264AY-133_	256MB	32 Meg x 64	133 MHz
MT16LSDT3264AG-10E_	256MB	32 Meg x 64	100 MHz
MT16LSDT3264AY-10E_	256MB	32 Meg x 64	100 MHz

NOTE:

The designators for component and PCB revision are the last two characters of each part number Consult factory for current revision codes. Example: MT16LSDT3264AG-133B1.

Functional Block Diagram - 128MB

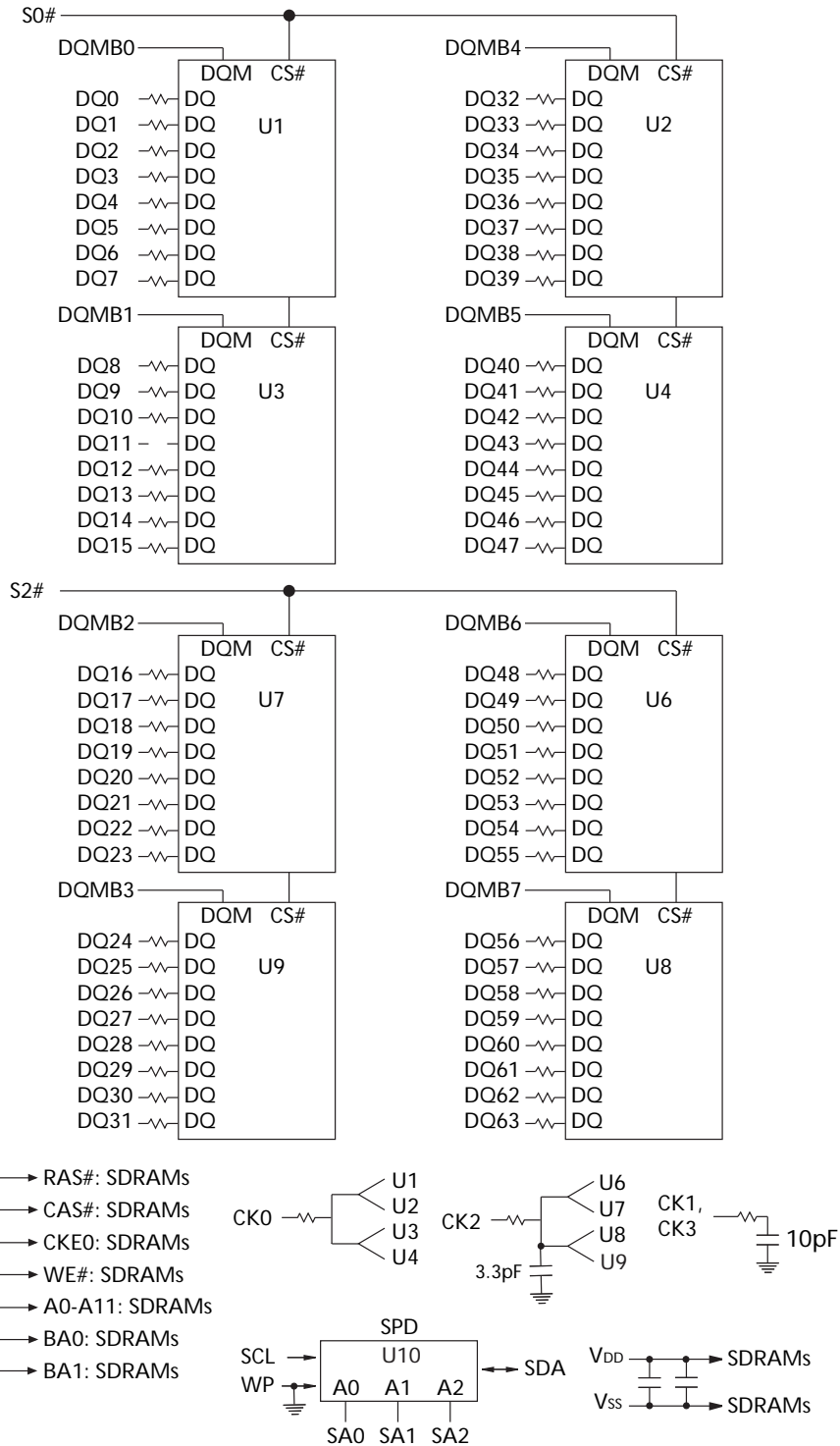

NOTE:

1. All resistor values are 10Ω unless otherwise specified.
2. Per industry standard, Micron modules utilize various component speed grades, as referenced in the module part numbering guide at www.micron.com/numberguide.

Standard modules use the following SDRAM devices:
MT48LC16M8A2TG

Lead-free modules use the following SDRAM devices:
MT48LC16M8A2P

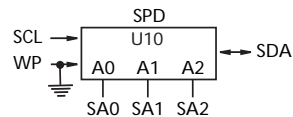
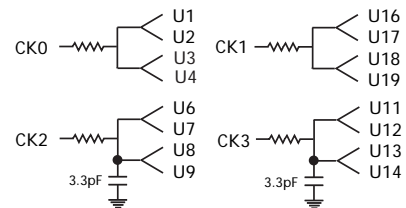
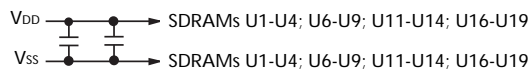
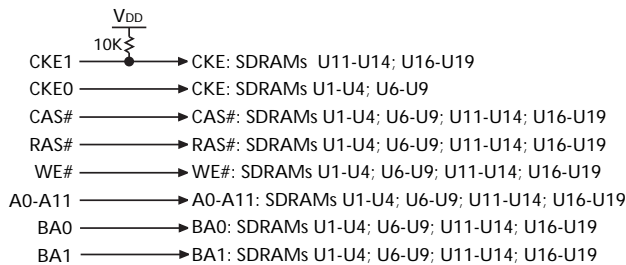
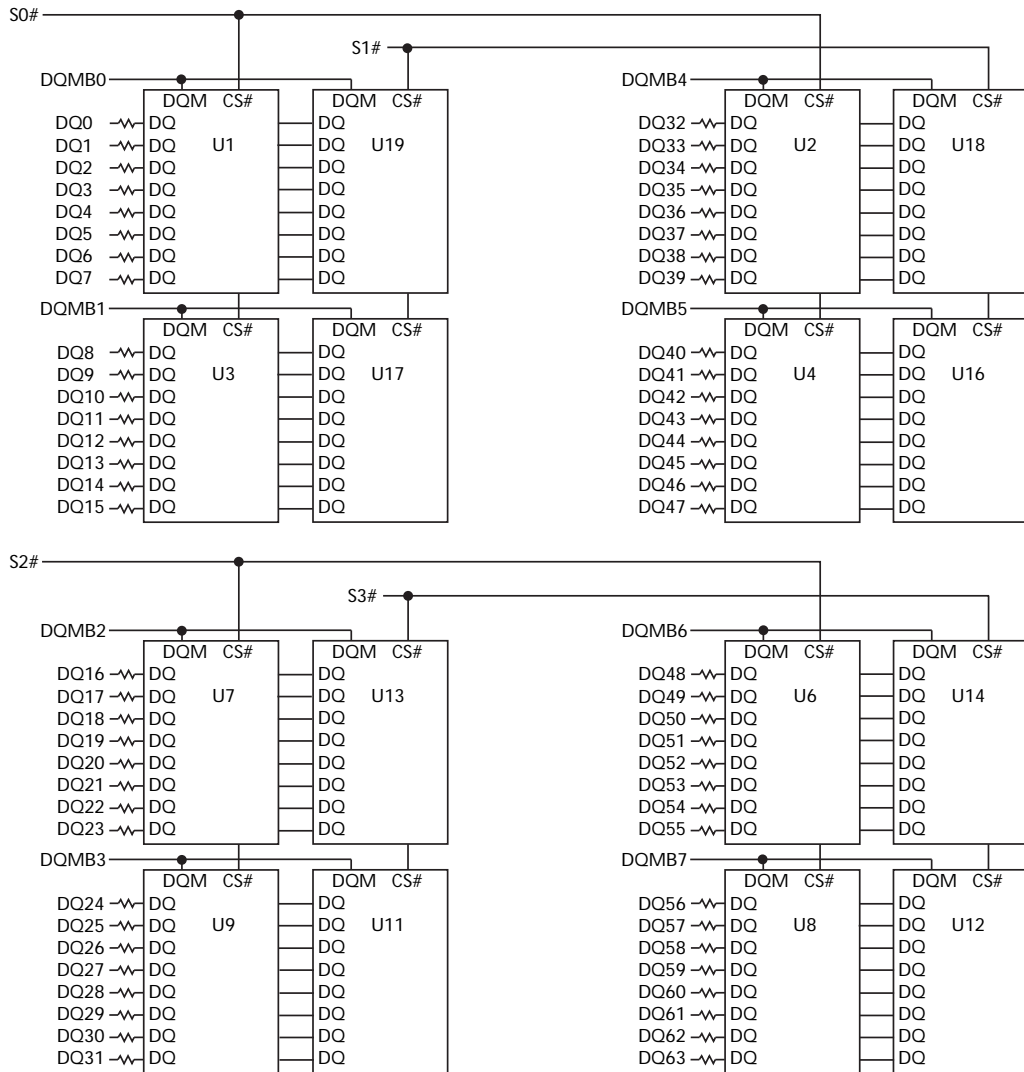

NOTE:

1. All resistor values are 10Ω unless otherwise specified.
2. Per industry standard, Micron modules utilize various component speed grades, as referenced in the module part numbering guide at www.micron.com/numberguide.

Standard modules use the following SDRAM devices:
MT48LC16M8A2TG

Lead-free modules use the following SDRAM devices:
MT48LC16M8A2P

Pin numbers may not correlate with symbols; refer to Pin Assignment tables on page 3 for more information

27, 115, 111	RAS#, CAS#, WE#	Input	Command Inputs: RAS#, CAS#, and WE# (along with S#) define the command being entered.
42, 79, 125, 163	CK0-CK3	Input	Clock: CK is driven by the system clock. All SDRAM input signals are sampled on the positive edge of CK. CK also increments the internal burst counter and controls the output registers.
63, 128	CKE0, CKE1	Input	Clock Enable: CKE0 activate (HIGH) and deactivate (LOW) the CK signal. Deactivating the clock provides PRECHARGE POWER-DOWN and SELF REFRESH operation (all device banks idle), ACTIVE POWER-DOWN (row ACTIVE in any device bank) or CLOCK SUSPEND operation (burst access in progress). CKE is synchronous except after the device enters power-down and self refresh modes, where CKE becomes asynchronous until after exiting the same mode. The input buffers, including CK, are disabled during power-down and self refresh modes, providing low standby power.
30, 45, 114, 129	S0#-S3#	Input	Chip Select: S# enables (registered LOW) and disables (registered HIGH) the command decoder. All commands are masked when S# is registered HIGH. S# is considered part of the command code.
28-29, 46-47, 112-113, 130-131	DQMB0-DQMB7	Input	Input/Output Mask: DQMB is an input mask signal for write accesses and an output enable signal for read accesses. Input data is masked when DQMB is sampled HIGH during a WRITE cycle. The output buffers are placed in a High-Z state (two-clock latency) when DQMB is sampled HIGH during a READ cycle.
39, 122	BA0, BA1	Input	Bank Address: BA0 and BA1 define to which device bank the ACTIVE, READ, WRITE, or PRECHARGE command is being applied.
33, 34, 35, 36, 37, 38, 117, 118, 119, 120, 121, 123	A0-A11	Input	Address Inputs: Provide the row address for ACTIVE commands, and the column address and auto precharge bit (A10) for READ/WRITE commands, to select one location out of the memory array in the respective device bank. A10 sampled during a PRECHARGE command determines whether the PRECHARGE applies to once device bank (A10 LOW, device bank selected by BA0, BA1) or all device banks (A10 HIGH). The address inputs also provide the op-code during a MODE REGISTER SET command.
83	SCL	Input	Serial Clock for Presence-Detect: SCL is used to synchronize the presence-detect data transfer to and from the module.
165-167	SA0-SA2	Input	Presence-Detect Address Inputs: These pins are used to configure the presence-detect device.
2-5, 7-11, 13-17, 19-20, 55-58, 60, 65-67, 69-72, 74-77, 86-89, 91-95, 97-101, 103-104, 139-142, 144, 149-151, 153-156, 158-161	DQ0-DQ63	Input/Output	Data I/O: Data bus.
82	SDA	Input/Output	Serial Presence-Detect Data: SDA is a bidirectional pin used to transfer addresses and data into and data out of the presence-detect portion of the module.
6, 18, 26, 40, 41, 49, 59, 73, 84, 90, 102, 110, 124, 133, 143, 157, 168	VDD	Supply	Power Supply: +3.3V ±0.3V.

Pin numbers may not correlate with symbols; refer to Pin Assignment tables on page 3 for more information

1, 12, 23, 32, 43, 54, 64, 68, 78, 85, 96, 107, 116, 127, 138, 148, 152, 162	Vss	Supply	Ground.
21, 22, 24, 25, 31, 44, 48, 50-53, 61, 62, 80, 81, 105, 106, 108, 109, 126, 132, 134-137, 145-147, 164	NC	-	Not Connected: These pins are not connected on this module.

General Description

signals CK).

Read and write accesses to the SDRAM modules are burst oriented; accesses start at a selected location and continue for a programmed number of locations in a programmed sequence. Accesses begin with the registration of an ACTIVE command, which is then followed by a READ or WRITE command. The address bits registered coincident with the ACTIVE command are used to select the device bank and row to be accessed (BA0, BA1 select the device bank, A0–A11 select the device row). The address bits registered coincident with the READ or WRITE command are used to select the starting column location for the burst access.

The modules provide for programmable READ or WRITE burst lengths of 1, 2, 4, or 8 locations, or the full page, with a burst terminate option. An AUTO PRECHARGE function may be enabled to provide a self-timed row precharge that is initiated at the end of the burst sequence.

SDRAM modules use an internal pipelined architecture to achieve high-speed operation. This architecture is compatible with the 2n rule of prefetch architectures, but it also allows the column address to be changed on every clock cycle to achieve a high-speed, fully random access. Precharging one device bank while accessing one of the other three device banks will hide the precharge cycles and provide seamless, high-speed, random-access operation.

SDRAM modules are designed to operate in 3.3V, low-power memory systems. An auto refresh mode is provided, along with a power-saving, power-down mode. All inputs and outputs are LVTTTL-compatible.

SDRAM modules offer substantial advances in DRAM operating performance, including the ability to synchronously burst data at a high data rate with automatic column-address generation, the ability to interleave between internal banks in order to hide precharge time and the capability to randomly change column addresses on each clock cycle during a burst access. For more information regarding SDRAM operation, refer to the 128Mb SDRAM component data sheets.

Serial Presence-Detect Operation

SDRAM modules incorporate serial presence-detect (SPD). The SPD function is implemented using a 2,048-bit EEPROM. This nonvolatile storage device contains 256 bytes. The first 128 bytes can be programmed by Micron to identify the module type and various SDRAM organizations and timing parameters. The remaining 128 bytes of storage are available for use by the customer. System READ/WRITE operations between the master (system logic) and the slave EEPROM device (DIMM) occur via a standard IIC bus using the DIMM's SCL (clock) and SDA (data) signals, together with SA (2:0), which provide eight unique DIMM/EEPROM addresses.

Initialization

DD and VDDQ (simultaneously) and the clock is stable (stable clock is defined as a signal cycling within timing constraints specified for the clock pin), the SDRAM requires a 100 μ s delay prior to issuing any command other than a COMMAND INHIBIT or NOP. Starting at some point during this 100 μ s period and continuing at least through the end of this period, Command Inhibit or NOP commands should be applied.

Once the 100 μ s delay has been satisfied with at least one Command Inhibit or NOP command having been applied, a PRECHARGE command should be applied. All device banks must then be precharged, thereby placing the device in the all banks idle state.

Once in the idle state, two AUTO refresh cycles must be performed. After the AUTO refresh cycles are complete, the SDRAM is ready for mode register programming. Because the mode register will power up in an unknown state, it should be loaded prior to applying any operational command.

Mode Register Definition

Burst Length

in conjunction with the BURST TERMINATE command to generate arbitrary burst lengths.

Reserved states should not be used, as unknown operation or incompatibility with future versions may result.

When a READ or WRITE command is issued, a block of columns equal to the burst length is effectively selected. All accesses for that burst take place within this block, meaning that the burst will wrap within the block if a boundary is reached, as shown in the Burst Definition Table. The block is uniquely selected by A1–A9 when the burst length is set to two; by A2–A9 when the burst length is set to four; and by A3–A9 when the burst length is set to eight. The remaining (least significant) address bit(s) is (are) used to select the starting location within the block. Full-page bursts wrap within the page if the boundary is reached, as shown in the Table 7.

Burst Type

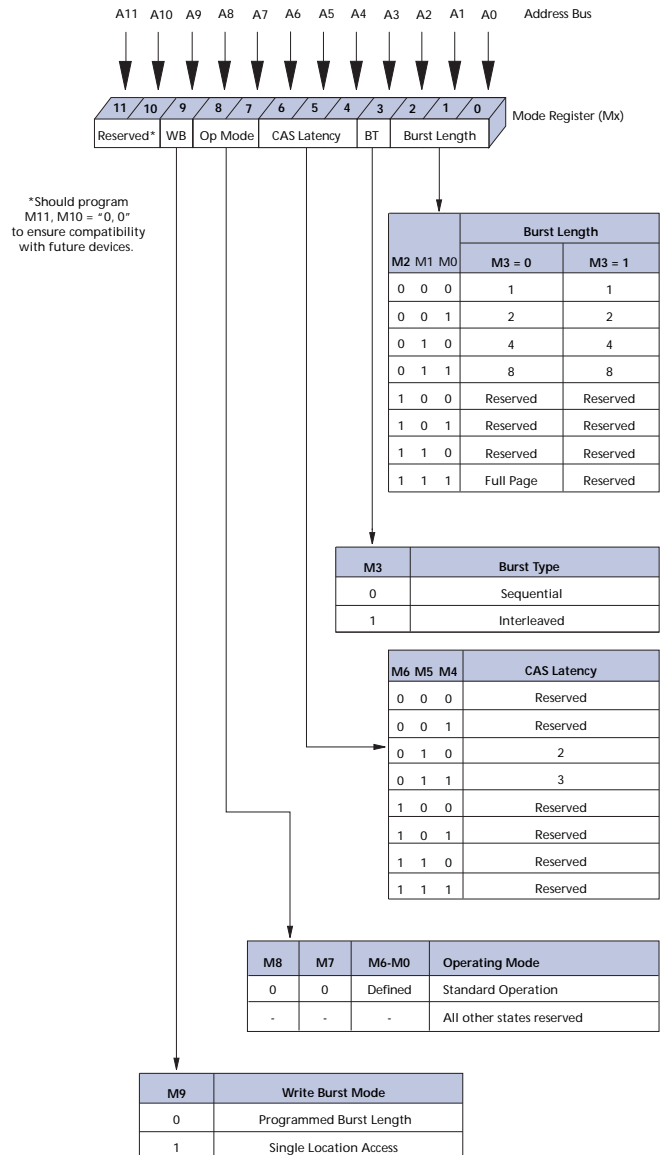

Table 7: Burst Definition

BURST LENGTH	STARTING COLUMN	ORDER OF ACCESSES WITHIN A BURST ADDRESS	
		TYPE = SEQUENTIAL	TYPE = INTERLEAVED
	A0		
	A1 A0		
	A2 A1 A0		
			Not Supported
		...Cn - 1, Cn...	

NOTE:

1. For full-page accesses: $y = 1,024$.
2. For a burst length of two, A1–A9 select the block-of-two burst; A0 selects the starting column within the block.
3. For a burst length of four, A2–A9 select the block-of-four burst; A0–A1 select the starting column within the block.
4. For a burst length of eight, A3–A9 select the block-of-eight burst; A0–A2 select the starting column within the block.
5. For a full-page burst, the full row is selected and A0–A9 select the starting column.
6. Whenever a boundary of the block is reached within a given sequence above, the following access wraps within the block.
7. For a burst length of one, A0–A9 select the unique column to be accessed, and mode register bit M3 is ignored.

CAS Latency Diagram

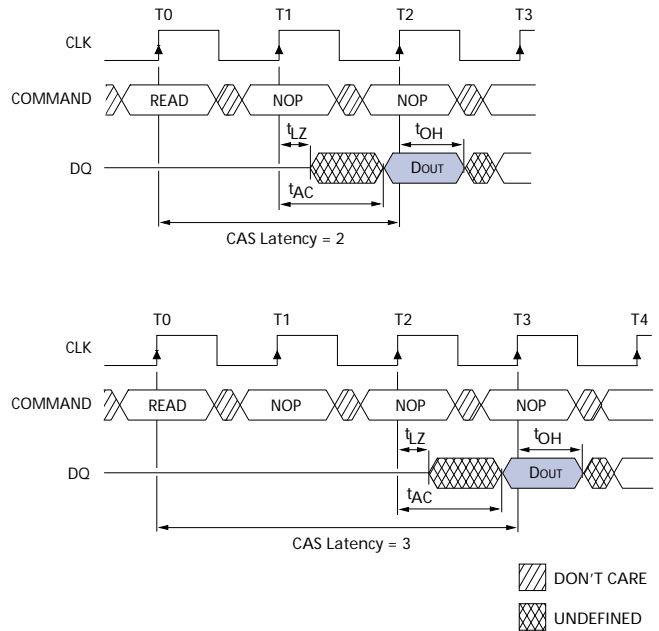

CAS Latency

Operating Mode



Write Burst Mode

	CLOCK FREQUENCY (MHZ)	
	CAS LATENCY = 2	CAS LATENCY = 3
	≤	≤
	≤	≤
	≤	≤

Table 9: SDRAM Commands and DQMB Operation Truth Table

NAME (FUNCTION)	CS#	RAS#	CAS#	WE#	DQMB	ADDR	DQ	NOTES
		X	X	X	X	X	X	
NO OPERATION (NOP)	L	H	H	H	X	X	X	
ACTIVE (Select bank and activate row)	L	L	H	H	X	Bank/Row	X	1
READ (Select bank and column, and start READ burst)	L	H	L	H	L/H8	Bank/Col	X	2
WRITE (Select bank and column, and start WRITE burst)	L	H	L	L	L/H8	Bank/Col	Valid	2
BURST TERMINATE	L	H	H	L	X	X	Active	
PRECHARGE (Deactivate row in bank or banks)	L	L	H	L	X	Code	X	3
AUTO refresh or Self Refresh (Enter self refresh mode)	L	L	L	H	X	X	X	4, 5
LOAD MODE REGISTER	L	L	L	L	X	Op-code	X	6
Write Enable/Output Enable	-	-	-	-	L	-	Active	7

NOTE:

1. A0–A11 provide device row address, and BA0, BA1 determine which device bank is made active.
2. A0–A9 provide device column address; A10 HIGH enables the auto precharge feature (nonpersistent), while A10 LOW disables the auto precharge feature; BA0, BA1 determine which device bank is being read from or written to.
3. A10 LOW: BA0, BA1 determine which device bank is being precharged. A10 HIGH: all device banks are precharged and BA0, BA1 are “Don’t Care.”
4. This command is AUTO REFRESH if CKE is HIGH, SELF REFRESH if CKE is LOW.
5. Internal refresh counter controls row addressing; all inputs and I/Os are “Don’t Care” except for CKE.
6. A0–A11 define the op-code written to the mode register.
7. Activates or deactivates the DQs during WRITES (zero-clock delay) and READs (two-clock delay).



Absolute Maximum Ratings

SS. -1V to +4.6V
Voltage on Inputs, NC or I/O Pins
Relative to VSS -1V to +4.6V

Operating Temperature
T_{OPR} (Commercial - ambient) 0°C to +65°C
Storage Temperature (plastic) -55°C to +150°C

Table 10: DC Electrical Characteristics and Operating Conditions – 128MB

PARAMETER/CONDITION	SYMBOL	MIN	MAX	UNITS	NOTES
	I _H	2	V _{DD} + 0.3	V	22
INPUT LOW VOLTAGE: Logic 0; All inputs	V _{IL}	-0.3	0.8	V	22
INPUT LEAKAGE CURRENT: Any input 0V ≤ V _{IN} ≤ V _{DD} (All other pins not under test = 0V)	Command and Address Inputs, CKE	-40	40	μA	33
	CK, S#	-20	20	μA	
	DQMB	-5	5	μA	
OUTPUT LEAKAGE CURRENT: DQ pins are disabled; 0V ≤ V _{OUT} ≤ V _{DDQ}	I _{OZ}	-5	5	μA	33
OUTPUT LEVELS: Output High Voltage (I _{OUT} = -4mA) Output Low Voltage (I _{OUT} = 4mA)	V _{OH}	2.4	-	V	
	V _{OL}	-	0.4	V	

Notes: 1, 5, 6; notes appear on page 18; V_{DD}, V_{DDQ} = +3.3V ±0.3V

PARAMETER/CONDITION	SYMBOL	MIN	MAX	UNITS	NOTES
SUPPLY VOLTAGE	V _{DD} , V _{DDQ}	3	3.6	V	
INPUT HIGH VOLTAGE: Logic 1; All inputs	V _{IH}	2	V _{DD} + 0.3	V	22
INPUT LOW VOLTAGE: Logic 0; All inputs	V _{IL}	-0.3	0.8	V	22
INPUT LEAKAGE CURRENT: Any input 0V ≤ V _{IN} ≤ V _{DD} (All other pins not under test = 0V)	Command and Address Inputs, CKE	-80	80	μA	33
	CK, S#	-20	20	μA	
	DQMB	-10	10	μA	
OUTPUT LEAKAGE CURRENT: DQ pins are disabled; 0V ≤ V _{OUT} ≤ V _{DDQ}	I _{OZ}	-10	10	μA	33
OUTPUT LEVELS: Output High Voltage (I _{OUT} = -4mA) Output Low Voltage (I _{OUT} = 4mA)	V _{OH}	2.4	-	V	
	V _{OL}	-	0.4	V	



DD Specifications and Conditions – 128MB

PARAMETER/CONDITION	SYMBOL	MAX			UNITS	NOTES	
		-13E	-133	-10E			
$t_{RC} = t_{RC} \text{ (MIN)}$	IDD1	1,280	1,200	1,120	mA	3, 18, 19, 30	
STANDBY CURRENT: Power-Down Mode; All device device banks idle; CKE = LOW	IDD2	16	16	16	mA	30	
STANDBY CURRENT: Active Mode; CKE = HIGH; CS# = HIGH; All device banks active after t_{RCD} met; No accesses in progress	IDD3	400	400	320	mA	3, 12, 19, 30	
OPERATING CURRENT: Burst Mode; Continuous burst; READ or WRITE; All device banks active	IDD4	1,320	1,280	1,200	mA	3, 18, 19, 30	
AUTO REFRESH CURRENT CKE = HIGH; CS# = HIGH	$t_{RFC} = t_{RFC} \text{ (MIN)}$	IDD5	2,640	2,480	2,160	mA	3, 12, 18, 19, 30, 31
	$t_{RFC} = 15.625\mu\text{s}$	IDD6	24	24	24	mA	
SELF REFRESH CURRENT: CKE \leq 0.2V	IDD7	16	16	16	mA	4	

Notes: 1, 5, 6, 11, 13; notes appear on page 18; VDD, VDDQ = +3.3V \pm 0.3V; SDRAM components only

PARAMETER/CONDITION	SYMBOL	MAX			UNITS	NOTES	
		-13E	-133	-10E			
OPERATING CURRENT: Active Mode; Burst = 2; READ or WRITE; $t_{RC} = t_{RC} \text{ (MIN)}$	IDD1 ^a	1,296	1,216	1,136	mA	3, 18, 19, 30	
STANDBY CURRENT: Power-Down Mode; All device banks idle; CKE = LOW	IDD2 ^b	32	32	32	mA	30	
STANDBY CURRENT: Active Mode; CKE = HIGH; CS# = HIGH; All device banks active after t_{RCD} met; No accesses in progress	IDD3 ^a	416	416	336	mA	3, 12, 19, 30	
OPERATING CURRENT: Burst Mode; Continuous burst; READ or WRITE; All device banks active	IDD4 ^a	1,336	1,216	1,136	mA	3, 18, 19, 30	
AUTO REFRESH CURRENT CS# = HIGH; CKE = HIGH	$t_{RFC} = t_{RFC} \text{ (MIN)}$	IDD5 ^b	5,280	4,960	4,320	mA	3, 12, 18, 19, 30, 31
	$t_{RFC} = 15.625\mu\text{s}$	IDD6 ^b	48	48	48	mA	
SELF REFRESH CURRENT: CKE \leq 0.2V	IDD7 ^b	32	32	32	mA	4	

a - Value calculated as one module rank in this operating condition, and all other ranks in Power-Down Mode.

b - Value calculated reflects all module ranks in this operating condition.

Input Capacitance: Command and Address	CI1	20	30.4	pF
Input Capacitance: CK	CI2	13.3	17.3	pF
Input Capacitance: S#	CI3	10	15.2	pF
Input Capacitance: CKE	CI4	20	30.4	pF
Input Capacitance: DQMB	CI5	2.5	3.8	pF
Input/Output Capacitance: DQ	CIO	4	6	pF

Input Capacitance: Command and Address	CI1	40	60.8	pF
Input Capacitance: CK	CI2	13.3	17.3	pF
Input Capacitance: S#	CI3	10	15.2	pF
Input Capacitance: CKE	CI4	20	30.4	pF
Input Capacitance: DQMB	CI5	5	7.6	pF
Input/Output Capacitance: DQ	CIO	8	12	pF



Notes: 5–9, 11, 32; notes appear on page 18; module AC timing parameters comply with PC100 and PC133 design specs, based on component parameters

Access time from CLK (pos. edge)	CL = 3	$t_{AC(3)}$		5.4		5.4		6	ns	27
	CL = 2	$t_{AC(2)}$		5.4		6		6	ns	
Address hold time		t_{AH}	0.8		0.8		1		ns	
Address setup time		t_{AS}	1.5		1.5		2		ns	
CLK high-level width		t_{CH}	2.5		2.5		3		ns	
CLK low-level width		t_{CL}	2.5		2.5		3		ns	
Clock cycle time	CL = 3	$t_{CK(3)}$	7		7.5		8		ns	23
	CL = 2	$t_{CK(2)}$	7.5		10		10		ns	23
CKE hold time		t_{CKH}	0.8		0.8		1		ns	
CKE setup time		t_{CKS}	1.5		1.5		2		ns	
CS#, RAS#, CAS#, WE#, DQM hold time		t_{CMH}	0.8		0.8		1		ns	
CS#, RAS#, CAS#, WE#, DQM setup time		t_{CMS}	1.5		1.5		2		ns	
Data-in hold time		t_{DH}	0.8		0.8		1		ns	
Data-in setup time		t_{DS}	1.5		1.5		2		ns	
Data-out high-impedance time	CL = 3	$t_{HZ(3)}$		5.4		5.4		6	ns	10
	CL = 2	$t_{HZ(2)}$		5.4		6		6	ns	10
Data-out low-impedance time		t_{LZ}	1		1		1		ns	
Data-out hold time (load)		t_{OH}	3		3		3		ns	
Data-out hold time (no load)		t_{OHN}	1.8		1.8		1.8		ns	28
ACTIVE to PRECHARGE command		t_{RAS}	37	120,000	44	120,000	50	120,000	ns	.
ACTIVE to ACTIVE command period		t_{RC}	60		66		70		ns	
ACTIVE to READ or WRITE delay		t_{RCD}	15		20		20		ns	
Refresh period (8,192 rows)		t_{REF}		64		64		64	ms	
AUTO REFRESH period		t_{RFC}	66		66		70		ns	
PRECHARGE command period		t_{RP}	15		20		20		ns	
ACTIVE bank a to ACTIVE bank b command		t_{RRD}	14		15		20		ns	
Transition time		t_T	0.3	1.2	0.3	1.2	0.3	1.2	ns	7
Write recovery time		t_{WR}	1 CLK + 7ns		1 CLK + 7.5ns		1 CLK + 7ns		ns	24
			14		15		15		ns	25
Exit self refresh to ACTIVE command		t_{XSR}	67		75		80		ns	20

(Notes: 5, 6, 7, 8, 9, 11, 32: notes appear following parameter tables)

READ/WRITE command to READ/WRITE command		^t CCD	1	1	1	^t CK	17
CKE to clock disable or power-down entry mode		^t CKED	1	1	1	^t CK	14
CKE to clock enable or power-down exit setup mode		^t PED	1	1	1	^t CK	14
DQM to input data delay		^t DQD	0	0	0	^t CK	17
DQM to data mask during WRITES		^t DQM	0	0	0	^t CK	17
DQM to data high-impedance during READs		^t DQZ	2	2	2	^t CK	17
WRITE command to input data delay		^t DWD	0	0	0	^t CK	17
Data-in to ACTIVE command		^t DAL	4	5	4	^t CK	15, 21
Data-in to precharge command		^t DPL	2	2	2	^t CK	16, 21
Last data-in to burst stop command		^t BDL	1	1	1	^t CK	17
Last data-in to new READ/WRITE command		^t CDL	1	1	1	^t CK	17
Last data-in to precharge command		^t RDL	2	2	2	^t CK	16, 21
LOAD MODE REGISTER command to ACTIVE or REFRESH command		^t MRD	2	2	2	^t CK	26
Data-out to high-impedance from precharge command	CL = 3	^t ROH(3)	3	3	3	^t CK	17
	CL = 2	^t ROH(2)	2	2	2	^t CK	17

1. All voltages referenced to Vss.
2. This parameter is sampled. VDD, VDDQ = +3.3V; f = 1 MHz, TA = 25°C; pin under test biased at 1.4V.
3. Idd is dependent on output loading and cycle rates. Specified values are obtained with minimum cycle time and the outputs open.
4. Enables on-chip refresh and address counters.
5. The minimum specifications are used only to indicate cycle time at which proper operation over the full temperature range is ensured (0°C ≤ TA ≤ +70°C).
6. An initial pause of 100μs is required after power-up, followed by two AUTO Refresh commands, before proper device operation is ensured. (VDD and VDDQ must be powered up simultaneously. Vss and VssQ must be at same potential.) The two AUTO Refresh command wake-ups should be repeated any time the tREF refresh requirement is exceeded.
7. AC characteristics assume tT = 1ns.
8. In addition to meeting the transition rate specification, the clock and CKE must transit between VIH and VIL (or between VIL and VIH) in a monotonic manner.
9. Outputs measured at 1.5V with equivalent load:

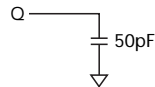

10. tHZ defines the time at which the output achieves the open circuit condition; it is not a reference to VOH or VOL. The last valid data element will meet tOH before going High-Z.
11. AC timing and Idd tests have VIL = 0V and VIH = 3V, with timing referenced to 1.5V crossover point. If the input transition time is longer than 1 ns, then the timing is referenced at VIL (MAX) and VIH (MIN) and no longer at the 1.5V crossover point.
12. Other input signals are allowed to transition no more than once every two clocks and are otherwise at valid VIH or VIL levels.
13. IDD specifications are tested after the device is properly initialized.
14. Timing actually specified by tCKS; clock(s) specified as a reference only at minimum cycle rate.
15. Timing actually specified by tWR plus tRP; clock(s) specified as a reference only at minimum cycle rate.
16. Timing actually specified by tWR.
17. Required clocks are specified by JEDEC functionality and are not dependent on any timing parameter.
18. The IDD current will increase or decrease proportionally according to the amount of frequency alteration for the test condition.
19. Address transitions average one transition every two clocks.
20. CLK must be toggled a minimum of two times during this period.
21. Based on tCK = 10ns for -10E, and tCK = 7.5ns for -133 and -13E.
22. VIH overshoot: VIH (MAX) = VDDQ + 2V for a pulse width ≤ 3ns, and the pulse width cannot be greater than one third of the cycle rate. VIL undershoot: VIL (MIN) = -2V for a pulse width ≤ 3ns.
23. The clock frequency must remain constant (stable clock is defined as a signal cycling within timing constraints specified for the clock pin) during access or precharge states (READ, WRITE, including tWR, and PRECHARGE commands). CKE may be used to reduce the data rate.
24. Auto precharge mode only. The precharge timing budget (tRP) begins 7ns for -13E; 7.5ns for -133 and 7ns for -10E after the first clock delay, after the last WRITE is executed. May not exceed limit set for precharge mode.
25. Precharge mode only.
26. JEDEC and PC100 specify three clocks.
27. tAC for -133/-13E at CL = 3 with no load is 4.6ns and is guaranteed by design.
28. Parameter guaranteed by design.
29. For -10E, CL = 2 and tCK = 10ns; for -133, CL = 3 and tCK = 7.5ns; for -13E, CL = 2 and tCK = 7.5ns.
30. CKE is HIGH during refresh command period tRFC (MIN) else CKE is LOW. The Idd6 limit is actually a nominal value and does not result in a fail value.
31. The value of tRAS used in -13E speed grade module SPDs is calculated from tRC - tRP = 45ns.
32. Refer to device data sheet for timing waveforms.
33. Leakage number reflects the worst case leakage possible through the module pin, not what each memory device contributes.

SPD Clock and Data Conventions

Data states on the SDA line can change only during SCL LOW. SDA state changes during SCL HIGH are reserved for indicating start and stop conditions (as shown in Figure 7, Data Validity, and Figure 8, Definition of Start and Stop).

SPD Start Condition

All commands are preceded by the start condition, which is a HIGH-to-LOW transition of SDA when SCL is HIGH. The SPD device continuously monitors the SDA and SCL lines for the start condition and will not respond to any command until this condition has been met.

SPD Stop Condition

All communications are terminated by a stop condition, which is a LOW-to-HIGH transition of SDA when SCL is HIGH. The stop condition is also used to place the SPD device into standby power mode.

SPD Acknowledge

Figure 7: Data Validity

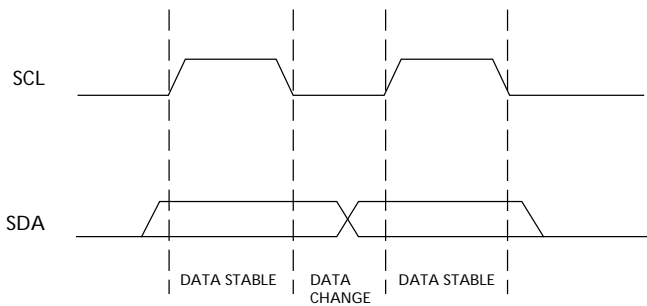

Figure 8: Definition of Start and Stop

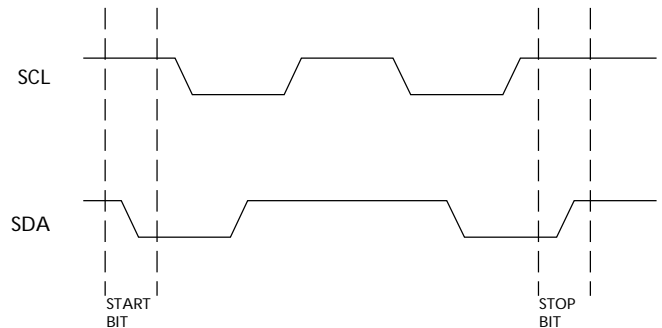

Figure 9: Acknowledge Response From Receiver

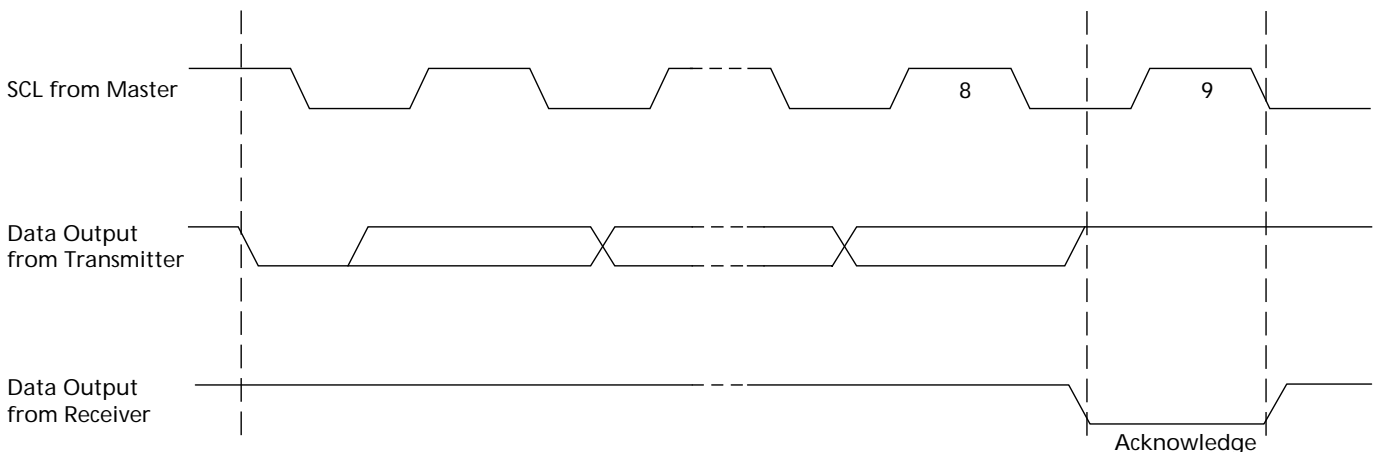

Table 18: EEPROM Device Select Code

SELECT CODE	DEVICE TYPE IDENTIFIER				CHIP ENABLE			R \bar{W}
	b7	b6	b5	b4	b3	b2	b1	b0
								—
								—

Table 19: EEPROM Operating Modes

MODE	R \bar{W} BIT	$\bar{W}C$	BYTES	INITIAL SEQUENCE
				—
				—
			\geq	—
			\leq	—

Figure 10: SPD EEPROM Timing Diagram

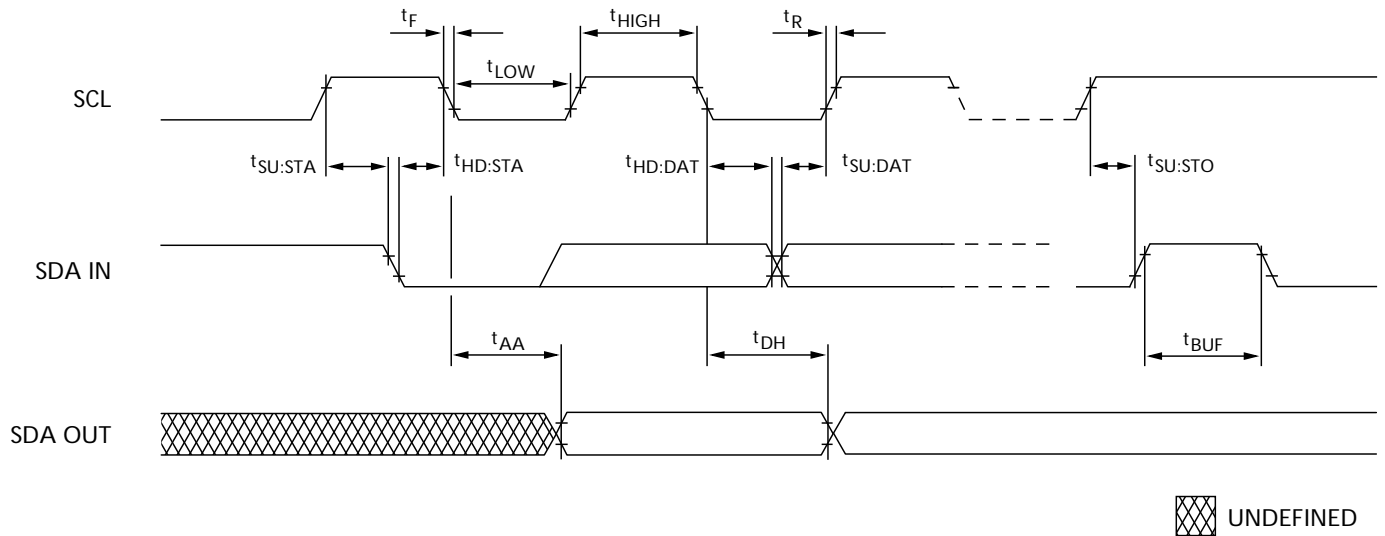

All voltages referenced to VSS; VDDSPD = +2.3V to +3.6V

SUPPLY VOLTAGE	VDDSPD	2.3	3.6	V
INPUT HIGH VOLTAGE: Logic 1; All inputs	Vih	VDDSPD × 0.7	VDDSPD + 0.5	V
INPUT LOW VOLTAGE: Logic 0; All inputs	VIL	-1	VDDSPD × 0.3	V
OUTPUT LOW VOLTAGE: IOUT = 3mA	VOL	-	0.4	V
INPUT LEAKAGE CURRENT: VIN = GND to VDD	ILI	-	10	μA
OUTPUT LEAKAGE CURRENT: VOUT = GND to VDD	ILO	-	10	μA
STANDBY CURRENT: SCL = SDA = VDD - 0.3V; All other inputs = VDD or VSS	ISB	-	30	μA
POWER SUPPLY CURRENT: SCL clock frequency = 100 KHz	ICC	-	2	mA

All voltages referenced to VSS; VDDSPD = +2.3V to +3.6V

SCL LOW to SDA data-out valid	^t AA	0.2	0.9	μs	1
Time the bus must be free before a new transition can start	^t BUF	1.3		μs	
Data-out hold time	^t DH	200		ns	
SDA and SCL fall time	^t F		300	ns	2
Data-in hold time	^t HD:DAT	0		μs	
Start condition hold time	^t HD:STA	0.6		μs	
Clock HIGH period	^t HIGH	0.6		μs	
Noise suppression time constant at SCL, SDA inputs	^t I		50	ns	
Clock LOW period	^t LOW	1.3		μs	
SDA and SCL rise time	^t R		0.3	μs	2
SCL clock frequency	^f SCL		400	KHz	
Data-in setup time	^t SU:DAT	100		ns	
Start condition setup time	^t SU:STA	0.6		μs	3
Stop condition setup time	^t SU:STO	0.6		μs	
WRITE cycle time	^t WRC		10	ms	4

NOTE:

1. To avoid spurious START and STOP conditions, a minimum delay is placed between SCL = 1 and the falling or rising edge of SDA.
2. This parameter is sampled.
3. For a reSTART condition, or following a WRITE cycle.
4. The SPD EEPROM WRITE cycle time (^tWRC) is the time from a valid stop condition of a write sequence to the end of the EEPROM internal erase/program cycle. During the WRITE cycle, the EEPROM bus interface circuit is disabled, SDA remains HIGH due to pull-up resistor, and the EEPROM does not respond to its slave address.



"1"/"0": Serial Data, "driven to HIGH"/"driven to LOW"

0	Number of Bytes Used by Micron	128	80	80
1	Total Number of SPD Memory Bytes	256	08	08
2	Memory Type	SDRAM	04	04
3	Number of Row Addresses	12	0C	0C
4	Number of Column Addresses	10	0A	0A
5	Number of Module Ranks	1 or 2	01	02
6	Module Data Width	64	40	40
7	Module Data Width (Continued)	0	00	00
8	Module Voltage Interface Levels	LVTTL	01	01
9	SDRAM Cycle Time, ^t CK, (CAS Latency = 3)	7 (-13E) 7.5 (-133) 8 (-10E)	70 75 80	70 75 80
10	SDRAM Access From Clock, ^t AC, (CAS Latency = 3)	5.4 (-13E/-133) 6 (-10E)	54 60	54 60
11	Module Configuration Type	NONPARITY	00	00
12	Refresh Rate/type	15.625μs/SELF	80	80
13	SDRAM Width (Primary SDRAM)	8	08	08
14	Error-Checking SDRAM Data Width	NONE	00	00
15	Minimum Clock Delay, ^t CCD	1	01	01
16	Burst Lengths Supported	1, 2, 4, 8, PAGE	8F	8F
17	Number of Banks on SDRAM Device	4	04	04
18	CAS Latencies Supported	2, 3	06	06
19	CS Latency	0	01	01
20	WE Latency	0	01	01
21	SDRAM Module Attributes	UNBUFFERED	00	00
22	SDRAM Device Attributes: General	0E	0E	0E
23	SDRAM Cycle Time, ^t CK, (CAS Latency = 2)	7.5 (13E) 10 (-133/-10E)	75 A0	75 A0
24	SDRAM Access From Clock, ^t AC, (CAS Latency = 2)	54 (-13E) 6 (-133/-10E)	54 60	54 60
25	SDRAM Cycle Time, ^t CK, (CAS Latency = 1)		00	00
26	SDRAM Access From Clock, ^t AC, (CAS Latency = 1)		00	00
27	Minimum Row Precharge Time, ^t RP	15 (-13E) 20 (-133/-10E)	0F 14	0F 14
28	Minimum Row Active to Row Active, ^t RRD	14 (-13E) 15 (-133) 20 (-10E)	0E 0F 14	0E 0F 14
29	Minimum RAS# to CAS# Delay, ^t RCD	15 (-13E) 20 (-133/-10E)	0F 14	0F 14
30	Minimum RAS# Pulse Width, ^t RAS (See note 1)	45 (-13E) 44 (-133) 50 (-10E)	2D 2C 32	2D 2C 32
31	Module Rank Density	128MB	20	20
32	Command Address Setup, ^t AS	1.5 (-13E/-133) 2 (-10E)	15 20	15 20

"1"/"0": Serial Data, "driven to HIGH"/"driven to LOW"

33	Command Address Hold, t_{AH}	0.8 (-13E/-133) 1 (-10E)	08 10	08 10
34	Data Signal Input Setup, t_{DS}	1.5 (-13E/-133) 2 (-10E)	15 20	15 20
35	Data Signal Input Hold, t_{DH}	0.8 (-13E/-133) 1 (-10E)	08 10	08 10
36-40	Reserved Bytes		00	00
41	Device Minimum Active/Auto-Refresh Time, t_{RC}	60ns (-13E) 66ns (-133) 70ns (-10E)	3C 42 46	3C 42 46
42-61	Reserved Bytes		00	00
62	SPD Revision	REV.2.0	02	12
63	Checksum For Bytes 0-62	(-13E) (-133) (-10E)	94 E0 2C	95 E1 2D
64	Manufacturer's JEDEC ID Code	MICRON	2C	2C
65-71	Manufacturer's JEDEC Code (Cont.)		FF	FF
72	Manufacturing Location	00-12	00-0C	00-0C
73-90	Module Part Number (ASCII)		Variable Data	Variable Data
91	PCB Identification Code		Variable Data	Variable Data
92	Identification Code (Continued)	0	00	00
93	Year of Manufacture in BCD		Variable Data	Variable Data
94	Week of Manufacture in BCD		Variable Data	Variable Data
95-98	Module Serial Number		Variable Data	Variable Data
99-125	Manufacturer-Specific Data (RSVD)			
126	System Frequency	100 MHz (-13E/-133, -10E)	64	64
127	Year of Manufacture in BCD		AF	FF

NOTE:

1. The value of t_{RAS} used for the -13E module is calculated from $t_{RC} - t_{RP}$. Actual device spec. vaule is 37ns.

Figure 11: 168-Pin DIMM Dimensions - 128MB

STANDARD PCB

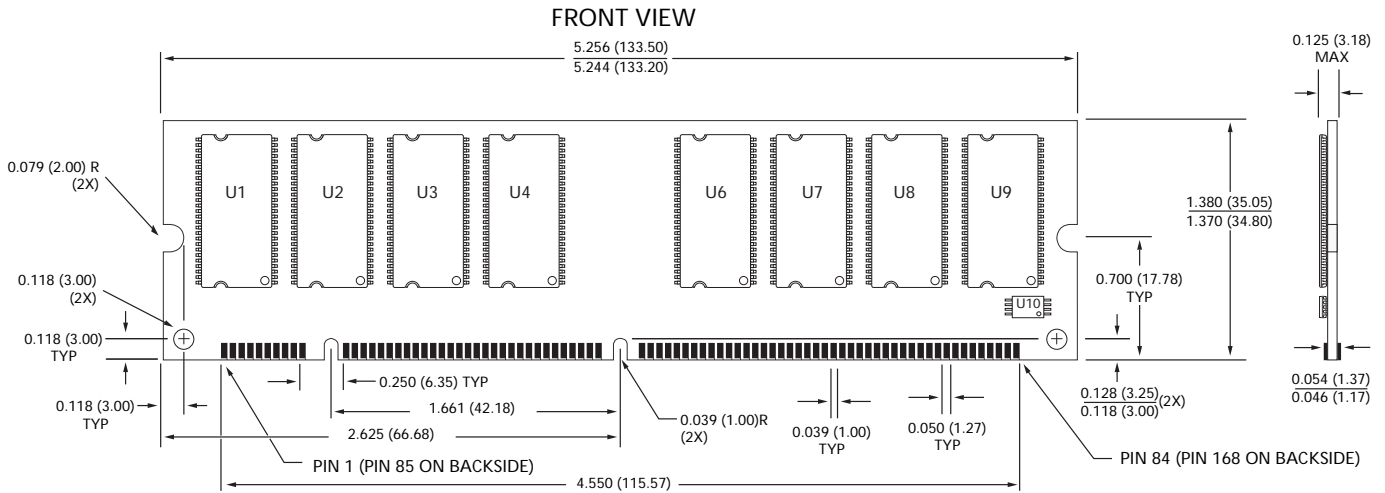

LOW PROFILE PCB

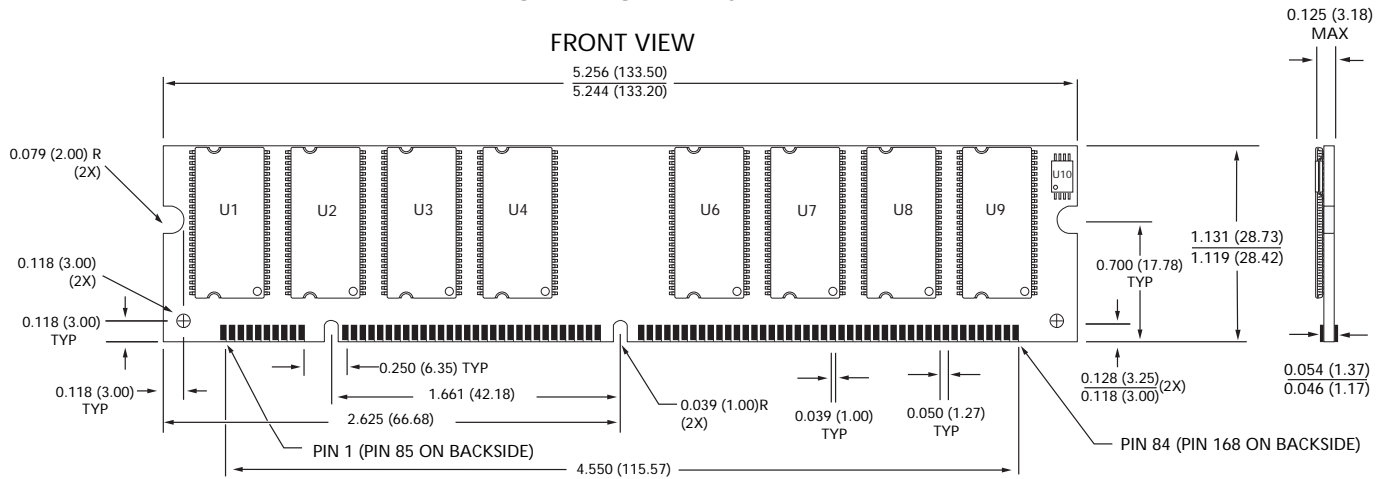

NOTE:

All dimensions in inches (millimeters); $\frac{\text{MAX}}{\text{MIN}}$ or typical where noted.

STANDARD PCB

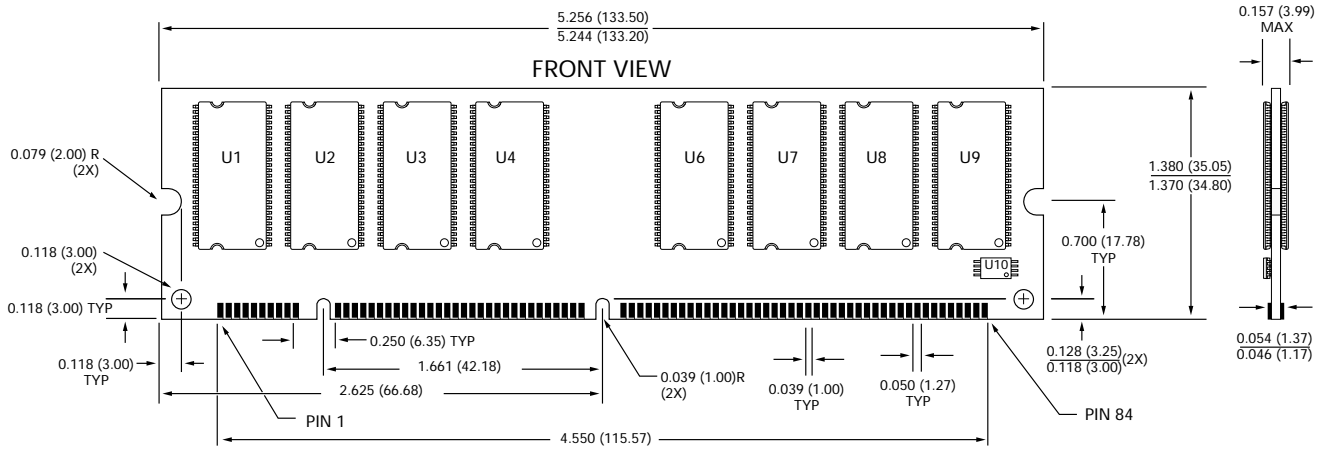

BACK VIEW

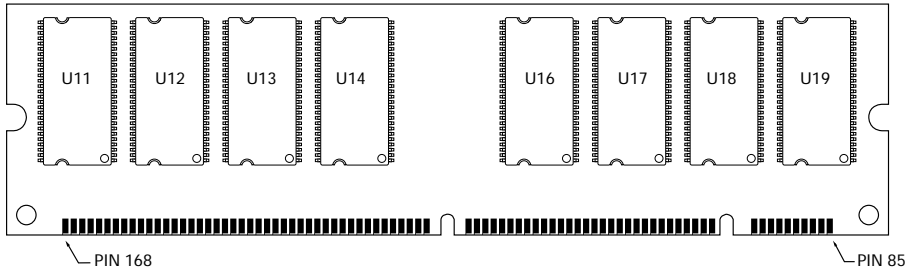

LOW PROFILE PCB

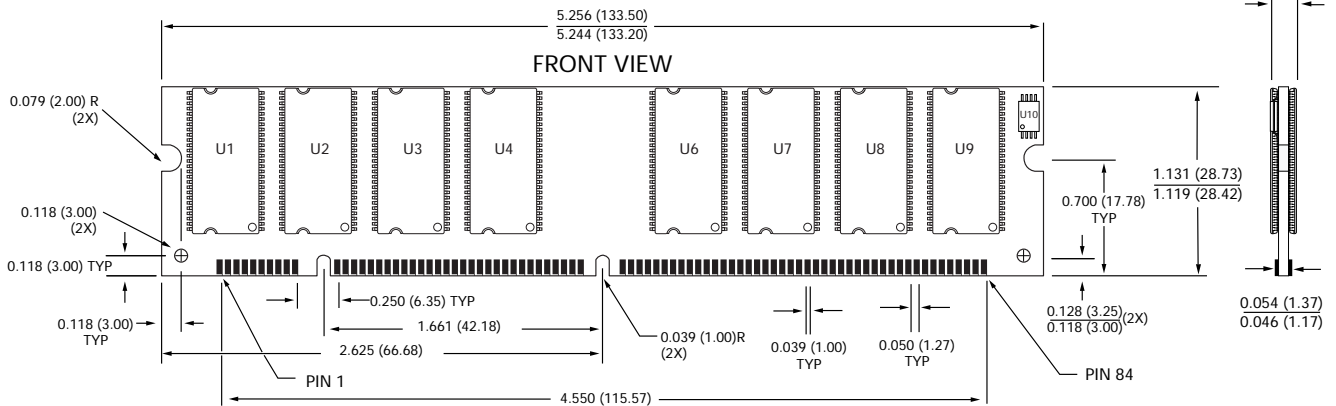

BACK VIEW

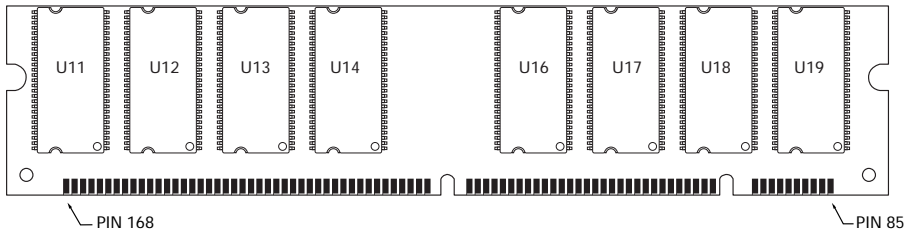

NOTE:

All dimensions in inches (millimeters); $\frac{\text{MAX}}{\text{MIN}}$ or typical where noted.



Released (No Mark):



8000 S. Federal Way, P.O. Box 6, Boise, ID 83707-0006, Tel: 208-368-3900

E-mail: prodmktg@micron.com, Internet: <http://www.micron.com>, Customer Comment Line: 800-932-4992

Micron, the M logo, and the Micron logo are trademarks of Micron Technology, Inc.

All other trademarks are the property of their respective owners.