

# C-Series SiPM Sensors

## Silicon Photomultipliers (SiPM), Low-Noise, Blue-Sensitive

The C-Series low-light sensors from ON Semiconductor feature an industry-leading low dark-count rate combined with a high PDE. For ultrafast timing applications, C-Series sensors have a fast output that can have a rise time of 300 ps and a pulse width of 600 ps. The C-Series is available in different sensor sizes (1 mm, 3 mm and 6 mm) and packaged in a 4-side tileable surface mount (SMT) package that is compatible with industry standard, lead-free, reflow soldering processes.

The C-Series Silicon Photomultipliers (SiPM) form a range of high gain, single-photon sensitive, UV-to-visible light sensors. They have performance characteristics similar to a conventional PMT, while benefiting from the practical advantages of solid-state technology: low operating voltage, excellent temperature stability, robustness, compactness, output uniformity, and low cost. For advice on the usage of these sensors please refer to the [Biasing and Readout](#) Application Note.



ON Semiconductor®

[www.onsemi.com](http://www.onsemi.com)

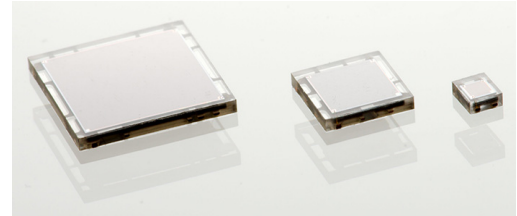

Figure 1. C-Series Sensors

### ORDERING INFORMATION

See detailed ordering and shipping information on page 15 of this data sheet.

Table 1. PERFORMANCE PARAMETERS

Sensor Size	Microcell Size	Parameter (Note 1)	Overvoltage	Min.	Typ.	Max.	Units
1 mm	10 $\mu$ , 20 $\mu$ , 35 $\mu$	Breakdown Voltage (Vbr) (Note 3)		24.2		24.7	V
3 mm	20 $\mu$ , 35 $\mu$ , 50 $\mu$						
6 mm	35 $\mu$						
1 mm	10 $\mu$ , 20 $\mu$ , 35 $\mu$	Recommended overvoltage Range (Voltage above Vbr) (Note 2)		1.0		5.0	V
3 mm	20 $\mu$ , 35 $\mu$ , 50 $\mu$						
6 mm	35 $\mu$						
1 mm	10 $\mu$ , 20 $\mu$ , 35 $\mu$	Spectral Range (Note 4)		300		950	nm
3 mm	20 $\mu$ , 35 $\mu$ , 50 $\mu$						
6 mm	35 $\mu$						
1 mm	10 $\mu$ , 20 $\mu$ , 35 $\mu$	Peak Wavelength ( $\lambda_p$ )			420		nm
3 mm	20 $\mu$ , 35 $\mu$ , 50 $\mu$						
6 mm	35 $\mu$						

## C-Series SiPM Sensors

**Table 1. PERFORMANCE PARAMETERS** (continued)

Sensor Size	Microcell Size	Parameter (Note 1)	Overvoltage	Min.	Typ.	Max.	Units		
1 mm	10 $\mu$	PDE (Note 5) at $\lambda_p$	Vbr + 2.5 V	14		%			
	20 $\mu$			24		%			
	35 $\mu$			31		%			
1 mm	10 $\mu$		Vbr + 5.0 V	18		%			
	20 $\mu$			31		%			
	35 $\mu$			41		%			
3 mm	20 $\mu$		Vbr + 2.5 V	24		%			
	35 $\mu$			31		%			
	50 $\mu$			35		%			
3 mm	20 $\mu$		Vbr + 5.0 V	31		%			
	35 $\mu$			41		%			
	50 $\mu$			47		%			
6 mm	35 $\mu$	Vbr + 2.5 V	31		%				
6 mm	35 $\mu$	Vbr + 5.0 V	41		%				
1 mm	10 $\mu$	Gain (anode to cathode readout)	Vbr + 2.5 V	$2 \times 10^5$					
	20 $\mu$			$1 \times 10^6$					
	35 $\mu$			$3 \times 10^6$					
3 mm	20 $\mu$			$1 \times 10^6$					
	35 $\mu$			$3 \times 10^6$					
	50 $\mu$			$6 \times 10^6$					
6 mm	35 $\mu$			$3 \times 10^6$					
1 mm	10 $\mu$			Dark Current (Note 6)	Vbr + 2.5 V		1	3	nA
	20 $\mu$						5	16	nA
	35 $\mu$		15			49	nA		
3 mm	20 $\mu$		50			142	nA		
	35 $\mu$		154			443	nA		
	50 $\mu$		319			914	nA		
6 mm	35 $\mu$		618			1750	nA		

## C-Series SiPM Sensors

**Table 1. PERFORMANCE PARAMETERS** (continued)

Sensor Size	Microcell Size	Parameter (Note 1)	Overvoltage	Min.	Typ.	Max.	Units	
1 mm	10 $\mu$	Dark Count Rate	Vbr + 2.5 V		30	96	kHz	
	20 $\mu$				30	96	kHz	
	35 $\mu$				30	96	kHz	
3 mm	20 $\mu$				300	860	kHz	
	35 $\mu$				300	860	kHz	
	50 $\mu$				300	860	kHz	
6 mm	35 $\mu$				1200	3400	kHz	
1 mm	10 $\mu$ , 20 $\mu$ , 35 $\mu$			Rise Time – Fast Output (Note 7)		0.3		ns
3 mm	20 $\mu$ , 35 $\mu$ , 50 $\mu$					0.6		ns
6 mm	35 $\mu$		1.0		ns			
1 mm	10 $\mu$ , 20 $\mu$ , 35 $\mu$	Signal Pulse Width – Fast Output (FWHM)		0.6		ns		
3 mm	20 $\mu$ , 35 $\mu$ , 50 $\mu$			1.5		ns		
6 mm	35 $\mu$			3.2		ns		
1 mm	10 $\mu$	Microcell recharge time constant (Note 8)		5		ns		
	20 $\mu$			23		ns		
	35 $\mu$			82		ns		
3 mm	20 $\mu$			23		ns		
	35 $\mu$			82		ns		
	50 $\mu$			159		ns		
6 mm	35 $\mu$			95		ns		
1 mm	10 $\mu$		Capacitance (Note 9) (anode-cathode)	Vbr + 2.5 V	50		pF	
	20 $\mu$				90		pF	
	35 $\mu$	100			pF			
3 mm	20 $\mu$	770			pF			
	35 $\mu$	850			pF			
	50 $\mu$	920			pF			
6 mm	35 $\mu$	3400			pF			
1 mm	10 $\mu$	Capacitance (Note 9) (fast terminal to cathode)			Vbr + 2.5 V	1		pF
	20 $\mu$					1		pF
	35 $\mu$		1			pF		

## C-Series SiPM Sensors

**Table 1. PERFORMANCE PARAMETERS** (continued)

Sensor Size	Microcell Size	Parameter (Note 1)	Overvoltage	Min.	Typ.	Max.	Units		
3 mm	20 $\mu$	Capacitance (Note 9) (fast terminal to cathode)	Vbr + 2.5 V	20			pF		
	35 $\mu$			12			pF		
	50 $\mu$			7			pF		
6 mm	35 $\mu$			48			pF		
1 mm	10 $\mu$ , 20 $\mu$ , 35 $\mu$	Temperature dependence of Vbr		21.5			mV/°C		
3 mm	20 $\mu$ , 35 $\mu$ , 50 $\mu$								
6 mm	35 $\mu$								
1 mm	10 $\mu$ , 20 $\mu$ , 35 $\mu$	Temperature dependence of Gain (Note 10)		-0.8			% / °C		
3 mm	20 $\mu$ , 35 $\mu$ , 50 $\mu$								
6 mm	35 $\mu$								
1 mm	10 $\mu$	Crosstalk	Vbr + 2.5 V	0.6			%		
	20 $\mu$			3			%		
	35 $\mu$			7			%		
3 mm	20 $\mu$			3			%		
	35 $\mu$			7			%		
	50 $\mu$			10			%		
6 mm	35 $\mu$			7			%		
1 mm	10 $\mu$			Afterpulsing	Vbr + 2.5 V	0.2			%
	20 $\mu$					0.2			%
	35 $\mu$	0.2					%		
3 mm	20 $\mu$	0.2					%		
	35 $\mu$	0.2					%		
	50 $\mu$	0.6					%		
6 mm	35 $\mu$	0.2					%		

1. All measurements made at 2.5 V overvoltage and 21°C unless otherwise stated.
2. Please consult the maximum current levels on page 6 when selecting the overvoltage to apply.
3. The breakdown voltage (Vbr) is defined as the value of the voltage intercept of a straight line fit to a plot of  $\sqrt{I}$  vs V, where I is the current and V is the bias voltage.
4. The range where PDE > 1% at Vbr + 5.0 V.
5. Note that the PDE does not contain contributions from afterpulsing or crosstalk.
6. Dark current derived from dark count data as  $DC \times M \times q \times (1 + CT)$ , where DC is dark count, M is gain, q is the charge of an electron, and CT is cross talk.
7. Measured as time to go from 10% to 90% of the peak amplitude.
8. RC charging time constant of the microcell ( $\tau$ )
9. Internal capacitance of the sensor. Typically add 2–3 pF for sensor in package. Listed by unique microcell size for each part version.
10. Quoted as the percentage change per degree C from the measured value at 21°C.

# C-Series SiPM Sensors

## GENERAL PARAMETERS

**Table 2. GENERAL PARAMETERS**

	1 mm	3 mm	6 mm
	10010, 10020, 10035	30020, 30035, 30050	60035
Active area	1 × 1 mm <sup>2</sup>	3 × 3 mm <sup>2</sup>	6 × 6 mm <sup>2</sup>
No. of microcells	10010: 2880 10020: 1296 10035: 504	30020: 10998 30035: 4774 30050: 2668	60035: 18980
Microcell fill factor	10010: 28% 10020: 48% 10035: 64%	30020: 48% 30035: 64% 30050: 72%	60035: 64%

**Table 3. PACKAGE PARAMETERS**

	1 mm	3 mm	6 mm
	10010, 10020, 10035	30020, 30035, 30050	60035
Package dimensions	1.5 × 1.8 mm <sup>2</sup>	4 × 4 mm <sup>2</sup>	7 × 7 mm <sup>2</sup>
Recommended operating temperature range	-40°C to +85°C		
Maximum storage temperature	+105°C		
Soldering conditions	Lead-free, reflow soldering process compatible (MSL 3 for tape & reel quantities; MSL 4 for tape only qty.) See the <a href="#">SMT Handling Tech Note</a> for more details.		
Encapsulant type	Clear transfer molding compound		
Encapsulant refractive Index	1.59 @ 420 nm		

**Table 4. MAXIMUM CURRENT LEVELS FOR EACH SENSOR SIZE**

1 mm	3 mm	6 mm
10010, 10020, 10035	30020, 30035, 30050	60035
6 mA	15 mA	20 mA

# C-Series SiPM Sensors

## CIRCUIT SCHEMATICS

An SiPM is formed of a large number (hundreds or thousands) of microcells. Each microcell is an avalanche photodiode with its own quench resistor and a capacitively coupled fast output.

a close-packed array with all of the like terminals (e.g. all of the anodes) summed together. The array of microcells can thus be considered as a single photodiode sensor with three terminals: anode, cathode and fast output.

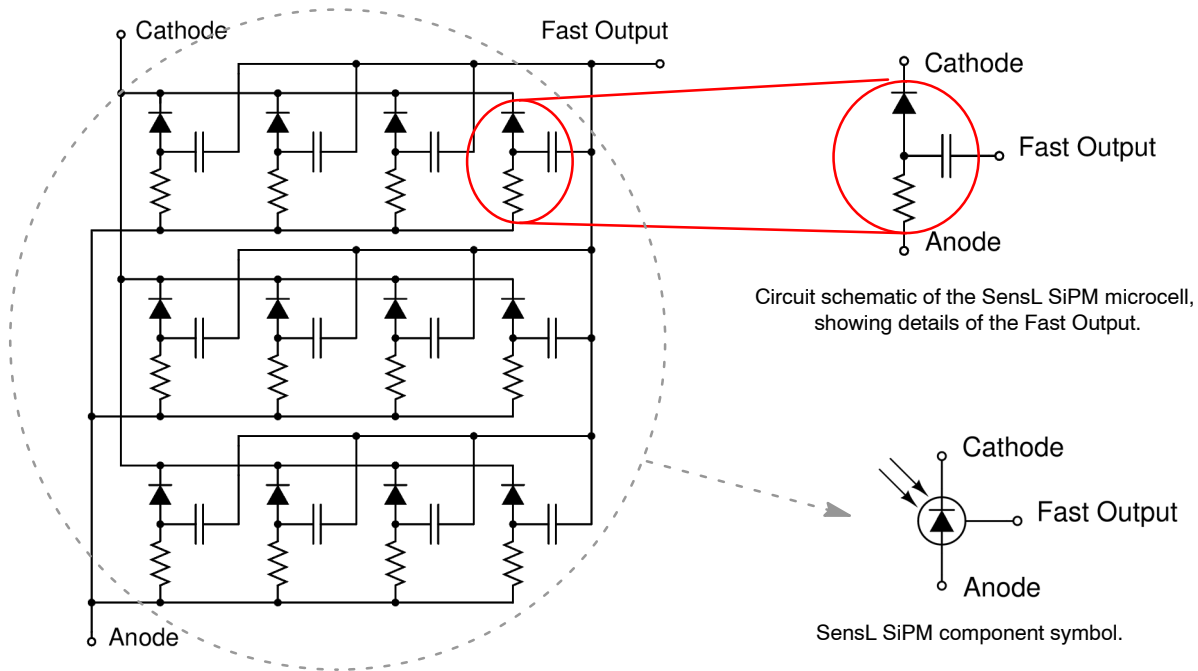

Simplified circuit schematic of the SensL<sup>®</sup> SiPM showing only a 12 microcell example. Typically, SiPM sensors have hundreds or thousands of microcells.

Figure 2. Circuit Schematic

# C-Series SiPM Sensors

## PERFORMANCE

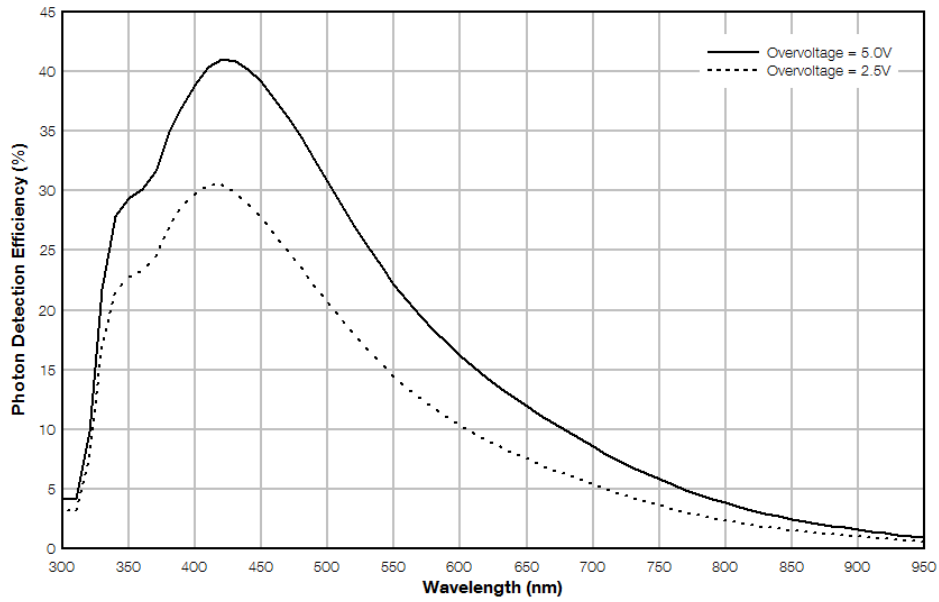

**Figure 3. PDE versus Wavelength**  
(MicroFC-30035-SMT)

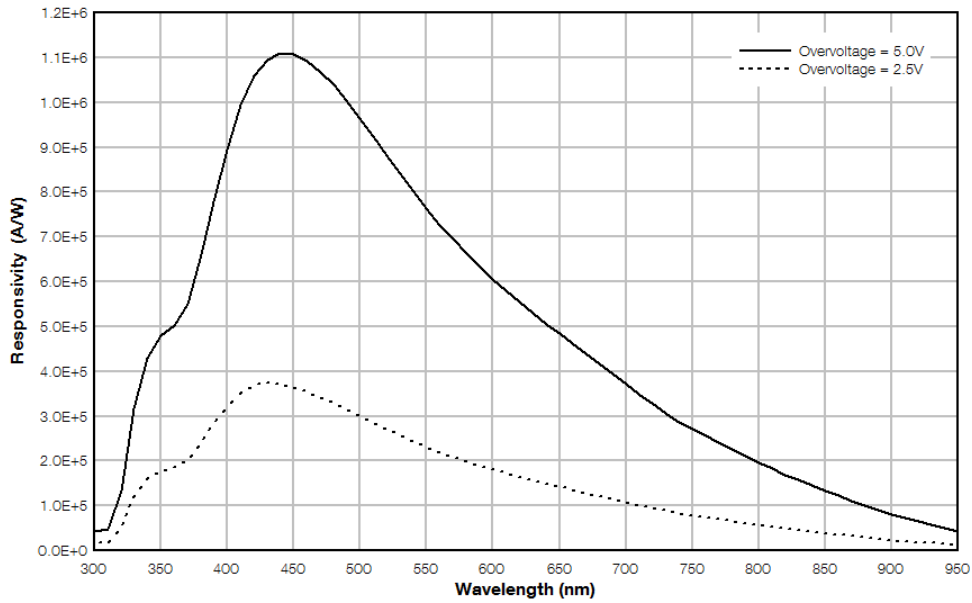

**Figure 4. Responsivity versus Wavelength**  
(MicroFC-30035-SMT)

# C-Series SiPM Sensors

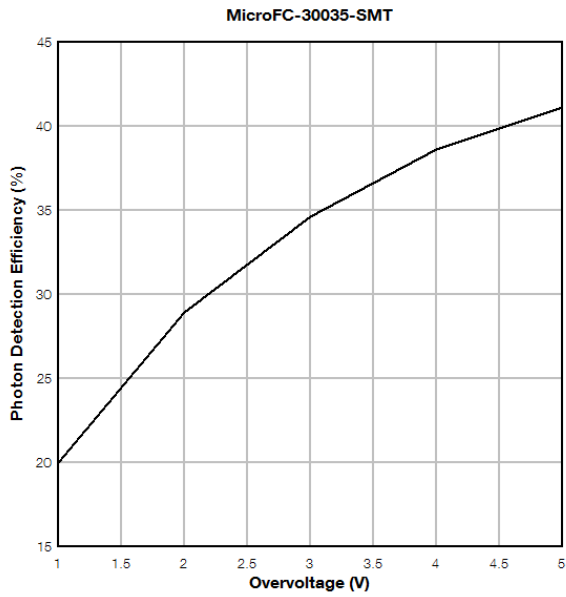

Figure 5. PDE at 420 nm versus Voltage

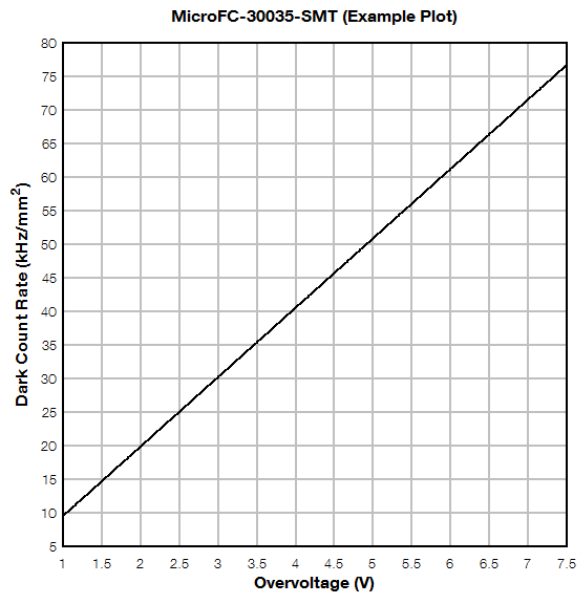

Figure 6. Dark Count Rate versus Overvoltage

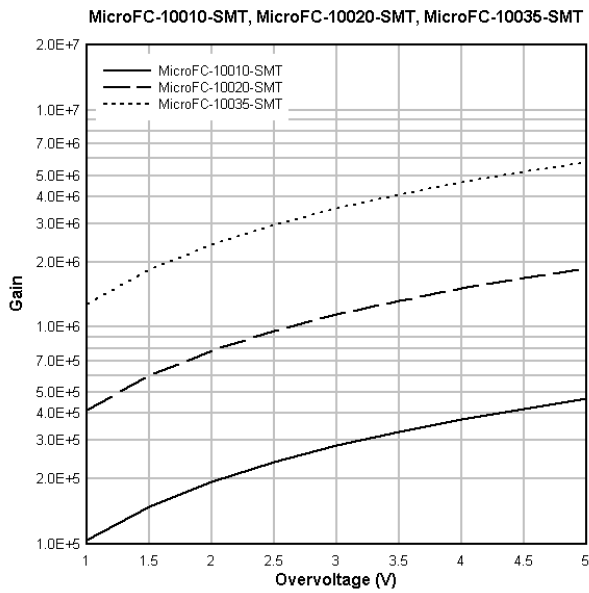

Figure 7. Gain versus Overvoltage

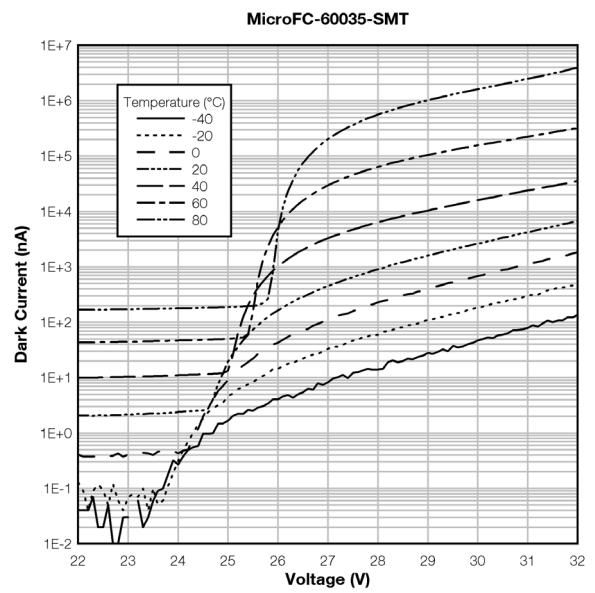

Figure 8. Dark Current versus Voltage and Temperature



# C-Series SiPM Sensors

## EVALUATION BOARD OPTIONS

### SMA Biasing Board (MicroFC-SMA-XXXXX)

The MicroFC-SMA is a printed circuit board (PCB) that can facilitate the evaluation of the C-Series SMT sensors. The board has three female SMA connectors for connecting the bias voltage, the standard output from the anode and the fast output signal. The output signals can be connected directly to a 50 Ω-terminated oscilloscope for viewing. The biasing and output signal tracks are laid out in such a way as to preserve the fast timing characteristics of the sensor.

The MicroFC-SMA is recommended for users who require a plug-and-play set-up to quickly evaluate C-Series SMT sensors with optimum timing performance. The board also allows the standard output from the anode-cathode readout to be observed at the same time as the fast output. The outputs can be connected directly to the oscilloscope or measurement device, but external preamplification may be required to boost the signal. The table below lists the SMA board connections. The SMA board electrical schematics are available to download in the [SMT Board Reference Design](#) document.

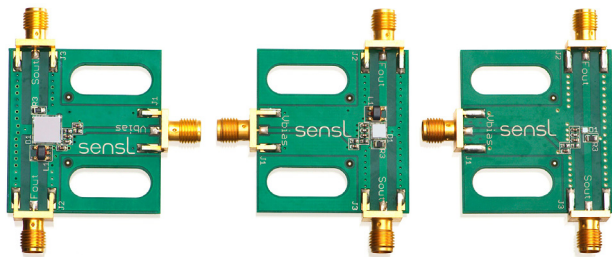

Figure 9. SMA Biasing Board

MicroFC-SMA-XXXXX	
Output	Function
Vbias	Positive bias input (cathode)
Fout	Fast output
Sout	Standard output (anode)

### Pin Adapter (MicroFC-SMTPA-XXXXX)

The SMT Pin Adapter board (SMTPA) is a small PCB board that houses the SMT sensor and has through-hole pins to allow for use with standard sockets or probe clips. This product is useful for those needing a quick way to evaluate the C-Series SMT sensors without the need for specialist surface-mount soldering. While this is a ‘quick fix’ suitable for many evaluations, it should be noted that the timing performance from this board will not be optimized and if the best possible timing performance is required, the MicroFC-SMA-XXXXX is recommended. The pin-out

information is shown in the table below. The SMTPA board electrical schematics are shown in Figure 12 and are available to download in the [SMT Board Reference Design](#) document.



Figure 10. Pin Adapter

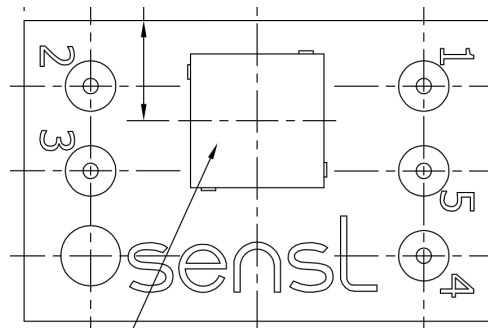

Figure 11. MicroFC-SMTPA-XXXXX

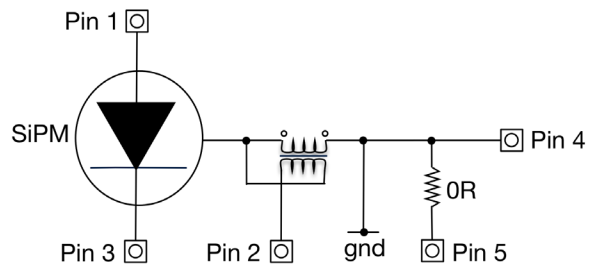

Figure 12. SMTPA Board Circuit Schematic

MicroFC-SMTPA-XXXXX	
Pin No.	Connection
1	Anode
2	Fast output
3	Cathode
4	Ground
5	No connect



# C-Series SiPM Sensors

## PACKAGE DIMENSIONS

(All Dimensions in mm)

### MicroFC-30035-SMT

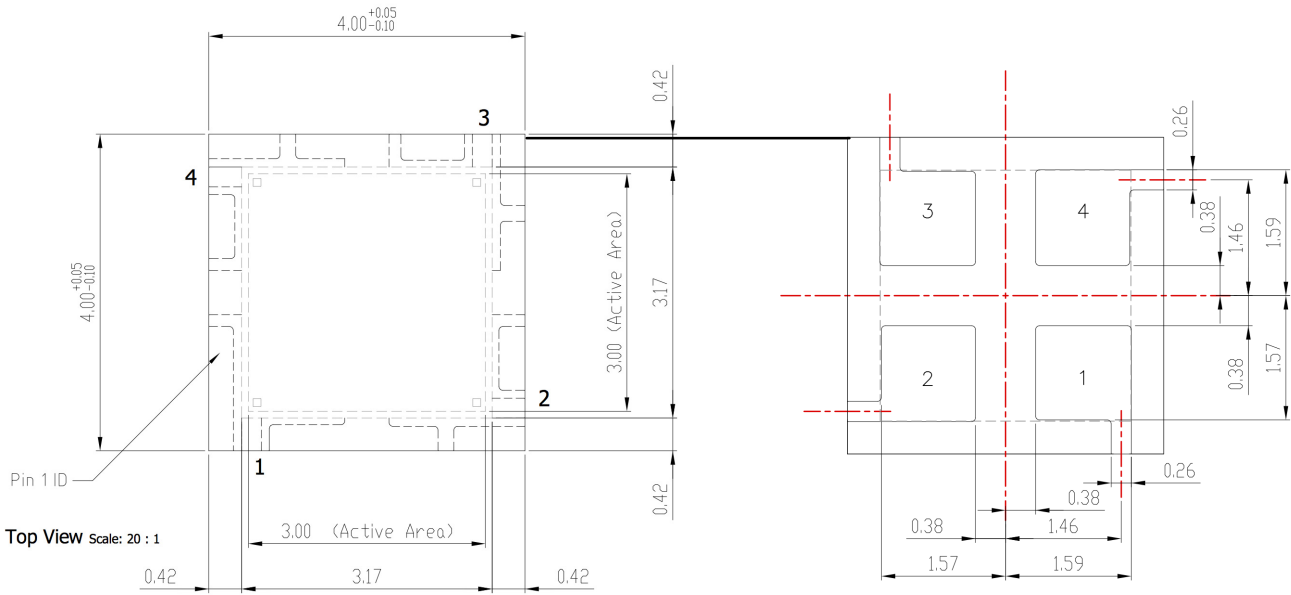

TOP VIEW

BOTTOM VIEW

SIDE VIEW

Pin Assignments	
Pin #	MicroFC-300XX-SMT
1	Anode
2	Fast Output
3	Cathode
4	No Connect*

\*The 'No Connect' pin 4 should be soldered to the PCB. It can be connected to ground but it can also be left floating without affecting the dark noise.

The complete MicroFC-30035-SMT CAD file, including solder footprint and tape and reel drawing, is available to download [here](#).

# C-Series SiPM Sensors

## PACKAGE DIMENSIONS

(All Dimensions in mm)

### MicroFC-30020-SMT & MicroFC-30050-SMT

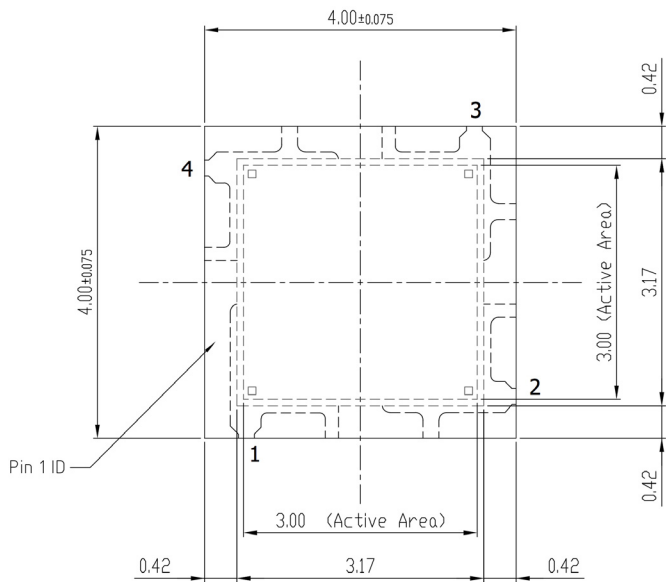

TOP VIEW

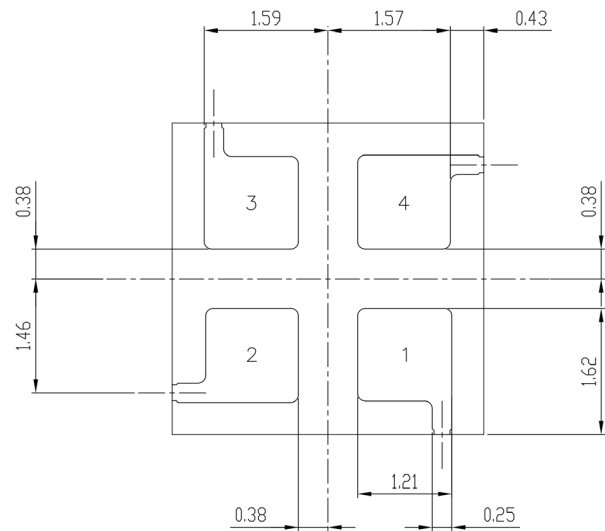

BOTTOM VIEW

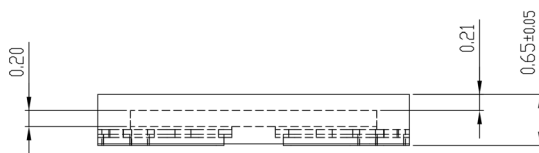

SIDE VIEW

Pin Assignments	
Pin #	MicroFC-300XX-SMT
1	Anode
2	Fast Output
3	Cathode
4	No Connect*

\*The 'No Connect' pin 4 should be soldered to the PCB. It can be connected to ground but it can also be left floating without affecting the dark noise.

The complete MicroFC-300XX-SMT CAD and solder footprint file is available to download [here](#).

# C-Series SiPM Sensors

## PACKAGE DIMENSIONS

(All Dimensions in mm)

### MicroFC-10010-SMT, MicroFC-10020-SMT & MicroFC-10035-SMT

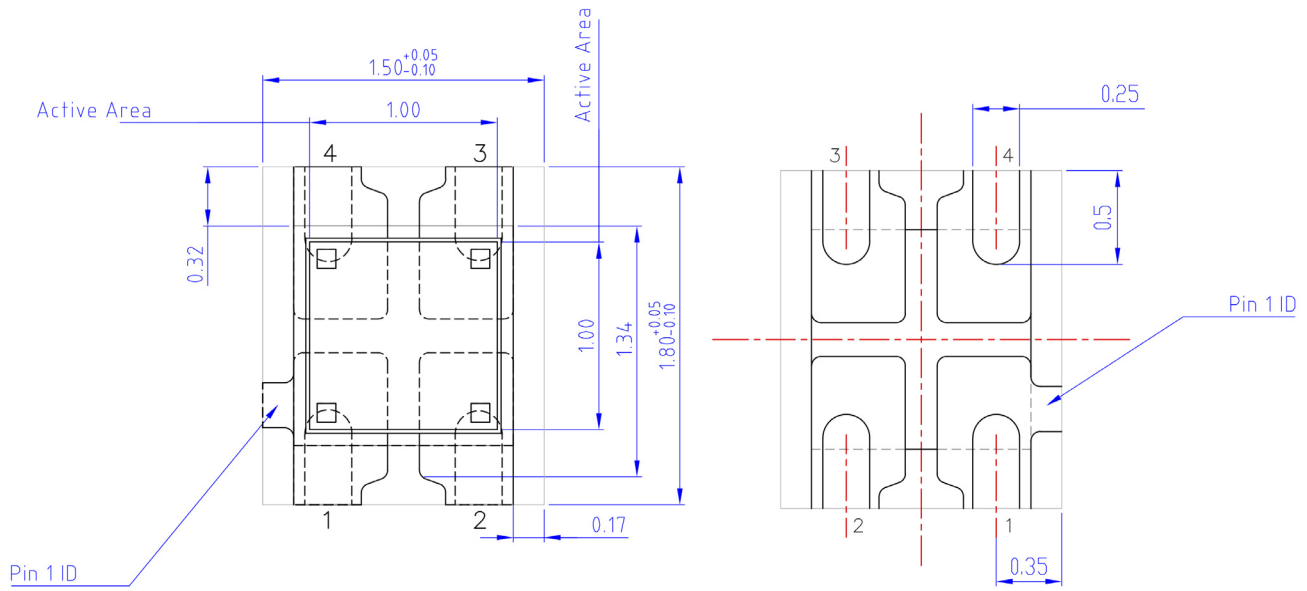

TOP VIEW

BOTTOM VIEW

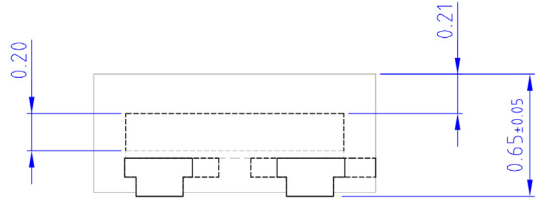

SIDE VIEW

Pin Assignments	
Pin #	MicroFC-100XX-SMT
1	Anode
2	Fast Output
3	Cathode
4	No Connect*

\*The 'No Connect' pin 4 should be soldered to the PCB. It can be connected to ground but it can also be left floating without affecting the dark noise.

The complete MicroFC-100XX-SMT CAD and solder footprint file is available to download [here](#).

# C-Series SiPM Sensors

## PACKAGE DIMENSIONS

(All Dimensions in mm)

### MicroFC-SMTPA Board

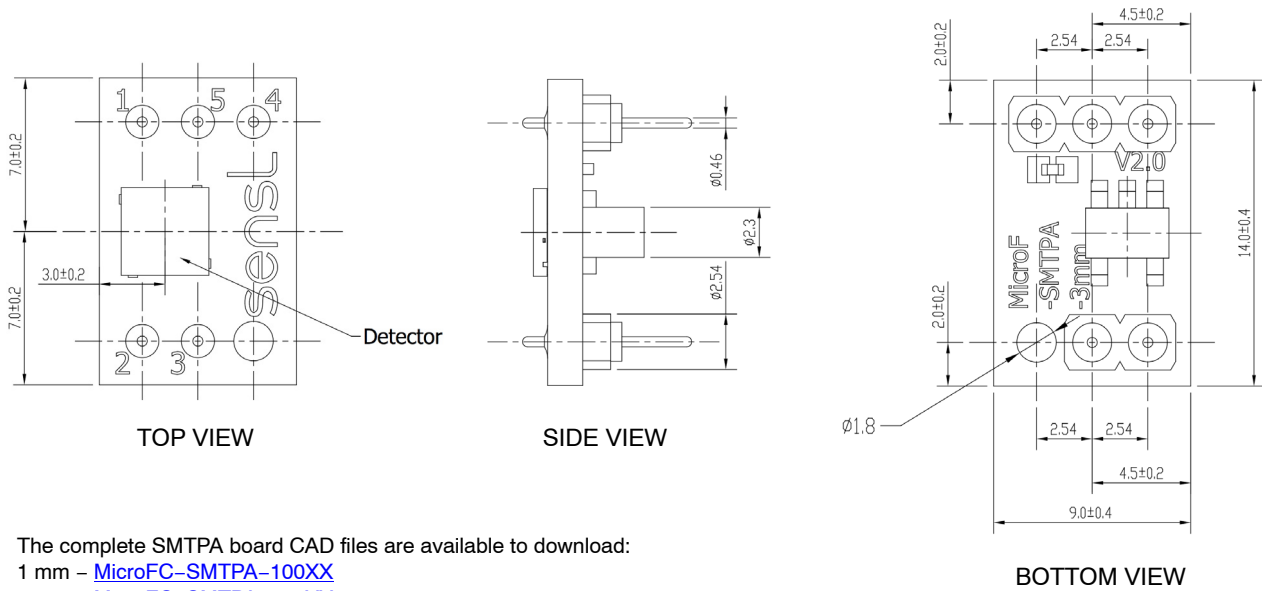

The complete SMTPA board CAD files are available to download:

1 mm - [MicroFC-SMTPA-100XX](#)

3 mm - [MicroFC-SMTPA-300XX](#)

6 mm - [MicroFC-SMTPA-60035](#)

The electrical schematics for the SMTPA board is available in the [SMT Board Reference Design](#) document.

### MicroFC-SMA Board

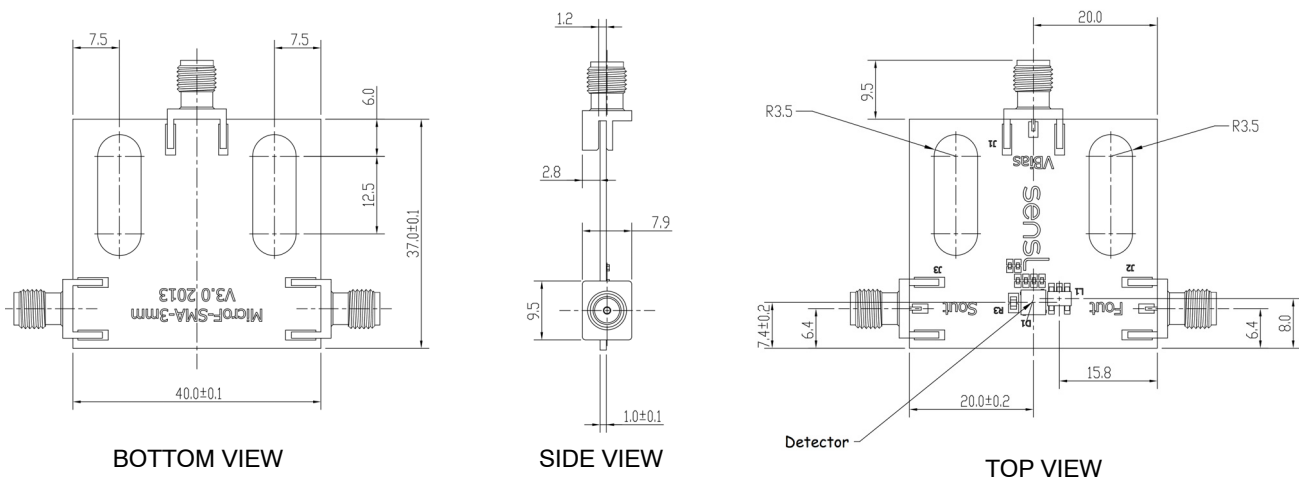

The complete SMA board CAD files are available to download:

1 mm - [MicroFC-SMA-100XX](#)

3 mm - [MicroFC-SMA-300XX](#)

6 mm - [MicroFC-SMA-60035](#)

The electrical schematics for the SMA board is available in the [SMT Board Reference Design](#) document.

## C-Series SiPM Sensors

### USEFUL LINKS

- [Introduction to Silicon Photomultipliers Application Note](#) – If you are new to SiPM, this document explains their operation and main performance parameters.
- [Biasing and Readout Application Note](#) – This document gives detailed information on how to bias the sensor for both standard and fast configurations, and amplifying and reading out the signal.
- [How to Evaluate and Compare Silicon Photomultipliers Application Note](#) – Information on what to consider when selecting an SiPM.
- [Handling and Soldering Guide](#) – This document gives information on safe handling of the sensors and soldering to PCB.
- [ON Semiconductor Website](#) – for more information on all of ON Semiconductor’s products as well as application information.
- [CAD file library](#) – ON Semiconductor CAD files include solder footprints and tape and reel information.
- [3D drawing library](#) – 3D files for ON Semiconductor products can be downloaded as SolidWorks, STEP and Inventor files.

### ORDERING INFORMATION

**Table 5. ORDERING INFORMATION**

Product Code (Note 11)	Microcell Size (Total Number)	Sensor Active Area	Package Type	Delivery Options (Note 12)
<b>10000 Series</b>				
MicroFC–10010–SMT	10 μm (2880 microcells)	1 mm × 1 mm	4-side tileable, surface mount package (SMT)	TR1, TR
MicroFC–SMA–10010			SMT sensor mounted onto a PCB with SMA connectors for bias and output.	PK
MicroFC–SMTPA–10010			SMT sensor mounted onto a pin adapter board.	PK
MicroFC–10020–SMT	20 μm (1296 microcells)		4-side tileable, surface mount package (SMT)	TR1, TR
MicroFC–SMA–10020			SMT sensor mounted onto a PCB with SMA connectors for bias and output.	PK
MicroFC–SMTPA–10020			SMT sensor mounted onto a pin adapter board.	PK
MicroFC–10035–SMT	35 μm (576 microcells)		4-side tileable, surface mount package (SMT)	TR1, TR
MicroFC–SMA–10035			SMT sensor mounted onto a PCB with SMA connectors for bias and output.	PK
MicroFC–SMTPA–10035			SMT sensor mounted onto a pin adapter board.	PK

## C-Series SiPM Sensors

**Table 5. ORDERING INFORMATION** (continued)

Product Code (Note 11)	Microcell Size (Total Number)	Sensor Active Area	Package Type	Delivery Options (Note 12)
<b>30000 Series</b>				
MicroFC-30020-SMT	20 $\mu\text{m}$ (10998 microcells)	3 mm $\times$ 3 mm	4-side tileable, surface mount package (SMT)	TR1, TR
MicroFC-SMA-30020			SMT sensor mounted onto a PCB with SMA connectors for bias and output.	PK
MicroFC-SMTPA-30020			SMT sensor mounted onto a pin adapter board	PK
MicroFC-30035-SMT	35 $\mu\text{m}$ (4774 microcells)		4-side tileable, surface mount package (SMT)	TR1, TR
MicroFC-SMA-30035			SMT sensor mounted onto a PCB with SMA connectors for bias and output.	PK
MicroFC-SMTPA-30035			SMT sensor mounted onto a pin adapter board	PK
MicroFC-30050-SMT	50 $\mu\text{m}$ (2668 microcells)		4-side tileable, surface mount package (SMT)	TR1, TR
MicroFC-SMA-30050			SMT sensor mounted onto a PCB with SMA connectors for bias and output.	PK
MicroFC-SMTPA-30050			SMT sensor mounted onto a pin adapter board	PK

**60000 Series**

MicroFC-60035-SMT	35 $\mu\text{m}$ (18980 microcells)	6mm $\times$ 6mm	4-side tileable, surface mount package (SMT)	TR1, TR
MicroFC-SMA-60035			SMT sensor mounted onto a PCB with SMA connectors for bias and output.	PK
MicroFC-SMTPA-60035			SMT sensor mounted onto a pin adapter board	PK

11. All Devices are Pb-Free and are RoHS Compliant.

12. The two-letter delivery option code should be appended to the order number, e.g.) to receive MicroFC-60035-SMT on tape and reel, use

MicroFC-60035-SMT-TR. The codes are as follows:

PK = ESD Package

TR1 = Tape

TR = Tape and Reel

There is a minimum order quantity (MOQ) of 3000 for the tape and reel (TR) option. The TR option is only available in multiples of the MOQ.

SensL is a registered trademark of of Semiconductor Components Industries, LLC (SCILLC) or its subsidiaries in the United States and/or other countries.

ON Semiconductor and  are trademarks of Semiconductor Components Industries, LLC dba ON Semiconductor or its subsidiaries in the United States and/or other countries. ON Semiconductor owns the rights to a number of patents, trademarks, copyrights, trade secrets, and other intellectual property. A listing of ON Semiconductor's product/patent coverage may be accessed at [www.onsemi.com/site/pdf/Patent-Marking.pdf](http://www.onsemi.com/site/pdf/Patent-Marking.pdf). ON Semiconductor reserves the right to make changes without further notice to any products herein. ON Semiconductor makes no warranty, representation or guarantee regarding the suitability of its products for any particular purpose, nor does ON Semiconductor assume any liability arising out of the application or use of any product or circuit, and specifically disclaims any and all liability, including without limitation special, consequential or incidental damages. Buyer is responsible for its products and applications using ON Semiconductor products, including compliance with all laws, regulations and safety requirements or standards, regardless of any support or applications information provided by ON Semiconductor. "Typical" parameters which may be provided in ON Semiconductor data sheets and/or specifications can and do vary in different applications and actual performance may vary over time. All operating parameters, including "Typicals" must be validated for each customer application by customer's technical experts. ON Semiconductor does not convey any license under its patent rights nor the rights of others. ON Semiconductor products are not designed, intended, or authorized for use as a critical component in life support systems or any FDA Class 3 medical devices or medical devices with a same or similar classification in a foreign jurisdiction or any devices intended for implantation in the human body. Should Buyer purchase or use ON Semiconductor products for any such unintended or unauthorized application, Buyer shall indemnify and hold ON Semiconductor and its officers, employees, subsidiaries, affiliates, and distributors harmless against all claims, costs, damages, and expenses, and reasonable attorney fees arising out of, directly or indirectly, any claim of personal injury or death associated with such unintended or unauthorized use, even if such claim alleges that ON Semiconductor was negligent regarding the design or manufacture of the part. ON Semiconductor is an Equal Opportunity/Affirmative Action Employer. This literature is subject to all applicable copyright laws and is not for resale in any manner.

**PUBLICATION ORDERING INFORMATION**

**LITERATURE FULFILLMENT:**

Literature Distribution Center for ON Semiconductor  
19521 E. 32nd Pkwy, Aurora, Colorado 80011 USA  
**Phone:** 303-675-2175 or 800-344-3860 Toll Free USA/Canada  
**Fax:** 303-675-2176 or 800-344-3867 Toll Free USA/Canada  
**Email:** [orderlit@onsemi.com](mailto:orderlit@onsemi.com)

**N. American Technical Support:** 800-282-9855 Toll Free  
USA/Canada  
**Europe, Middle East and Africa Technical Support:**  
Phone: 421 33 790 2910

**ON Semiconductor Website:** [www.onsemi.com](http://www.onsemi.com)  
**Order Literature:** <http://www.onsemi.com/orderlit>

For additional information, please contact your local Sales Representative