



High-Supply-Voltage, Precision Voltage Reference in SOT23

MAX6035

General Description

The MAX6035 is a high-voltage, precision micropower voltage reference. This three-terminal device is available with output voltage options of 2.5V, 3.0V, and 5.0V. It is an excellent upgrade for industry-standard devices such as the REF02 and REF43. The MAX6035 offers 14x lower power than the REF02 and 5x lower power than the REF43, as well as a reduced package size from an 8-pin SO to a 3-pin SOT23. The MAX6035 features a proprietary temperature coefficient curvature-correction circuit and laser-trimmed, thin-film resistors that result in a very low temperature coefficient of 25ppm/°C (max) and an initial accuracy of $\pm 0.2\%$ (max).

The MAX6035 typically draws only 73 μ A of supply current and can source 10mA or sink 2mA of load current. Unlike conventional shunt-mode (two-terminal) references that waste supply current and require an external resistor, this device offers a supply current that is virtually independent of the supply voltage and does not require an external resistor. Additionally, this internally compensated device does not require an external compensation capacitor, but is also stable with capacitive loads up to 5 μ F. Eliminating the external compensation capacitor saves valuable board area in space-critical applications. The supply independent, ultra-low supply current makes this device ideal for battery-operated, high-performance systems.

The MAX6035 is available in a 3-pin SOT23 package and is specified for operation from -40°C to +125°C.

Applications

4mA to 20mA Industrial Control Loops	Digital Multimeters
Li+ Battery Chargers	Portable Data-Acquisition Systems
12-Bit A/D and D/A Converters	Low-Power Test Equipment

Typical Operating Circuit

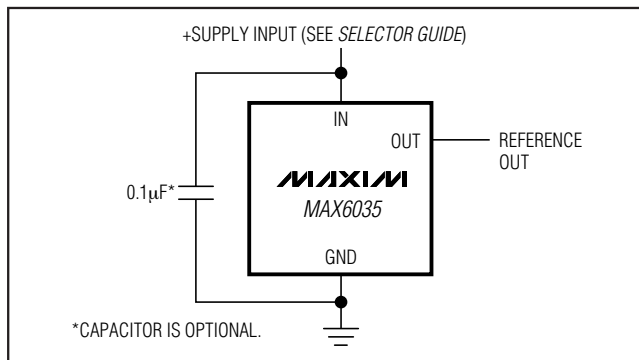

Features

- ◆ Wide Supply Voltage Range: Up to 33V
- ◆ 25ppm/°C (max) Temperature Coefficient (-40°C to +85°C)
- ◆ $\pm 0.2\%$ (max) Initial Accuracy
- ◆ 95 μ A (max) Quiescent Supply Current
- ◆ 10mA Source Current, 2mA Sink Current
- ◆ No Output Capacitor Required
- ◆ Stable with Capacitive Loads up to 5 μ F

Ordering Information

PART	TEMP RANGE	PIN-PACKAGE	TOP MARK
MAX6035AAUR25-T	-40°C to +125°C	3 SOT23-3	FZMW
MAX6035BAUR25-T	-40°C to +125°C	3 SOT23-3	FZMX
MAX6035ESA25	-40°C to +85°C	8 SO	—
MAX6035AAUR30-T	-40°C to +125°C	3 SOT23-3	FZMY
MAX6035BAUR30-T	-40°C to +125°C	3 SOT23-3	FZMZ
MAX6035AAUR50-T	-40°C to +125°C	3 SOT23-3	FZNA
MAX6035BAUR50-T	-40°C to +125°C	3 SOT23-3	FZNB

Note: The 3-pin SOT23 package code is U3-1. The 8-pin SO package code is S8-2.

Selector Guide

PART	MAXIMUM TEMPCO (ppm/°C) (-40°C to +85°C)	MAXIMUM INITIAL ACCURACY (%)	OUTPUT VOLTAGE (V)
MAX6035AAUR25	25	0.20	2.5
MAX6035BAUR25	65	0.50	2.5
MAX6035ESA25	40	0.20	2.5
MAX6035AAUR30	25	0.20	3.0
MAX6035BAUR30	65	0.50	3.0
MAX6035AAUR50	25	0.20	5.0
MAX6035BAUR50	65	0.50	5.0

Pin Configurations

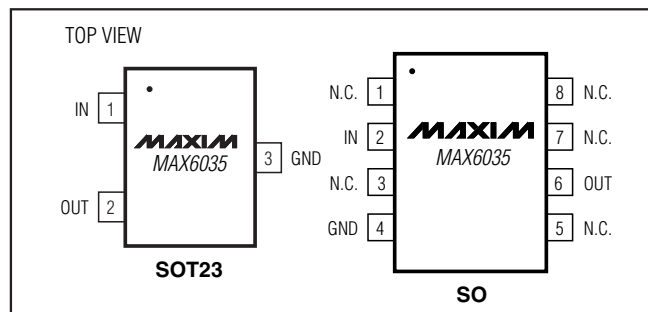

MAXIM

Maxim Integrated Products 1

For pricing, delivery, and ordering information, please contact Maxim/Dallas Direct! at 1-888-629-4642, or visit Maxim's website at www.maxim-ic.com.

High-Supply-Voltage, Precision Voltage Reference in SOT23

ABSOLUTE MAXIMUM RATINGS

(Voltages referenced to GND)

IN	-0.3V to +36V
OUT	-0.3V to (V _{IN} + 0.3V)
OUT Short-Circuit Duration to GND or IN (Note 1)	Continuous
Current into Any Pin	±20mA
Continuous Power Dissipation	
3-Pin SOT23 (derate 4.0mW/°C above +70°C)	320mW
8-Pin SO (derate 5.9mW/°C above +70°C)	470.6mW

Operating Temperature Range:

MAX6035ESA	-40°C to +85°C
MAX6035_AUR	-40°C to +125°C
Storage Temperature Range	-65°C to +150°C
Junction Temperature	+150°C
Lead Temperature (soldering, 10s)	+300°C

Note 1: Continuous power dissipation should also be observed.

Stresses beyond those listed under "Absolute Maximum Ratings" may cause permanent damage to the device. These are stress ratings only, and functional operation of the device at these or any other conditions beyond those indicated in the operational sections of the specifications is not implied. Exposure to absolute maximum rating conditions for extended periods may affect device reliability.

ELECTRICAL CHARACTERISTICS—MAX6035_AUR25 and MAX6035ESA25 (2.5V)

(V_{IN} = 5V, I_{OUT} = 0, T_A = T_{MIN} to T_{MAX}, unless otherwise noted. Typical values are at T_A = +25°C.) (Note 2)

PARAMETER	SYMBOL	CONDITIONS		MIN	TYP	MAX	UNITS		
Output Voltage	V _{OUT}	T _A = +25°C	MAX6035AAUR, MAX6035ESA (0.2%)	2.4950	2.5000	2.5050	V		
			MAX6035BAUR	2.4875	2.5000	2.5125			
Output Voltage Temperature Coefficient (Notes 3 and 6)	TCV _{OUT}	T _A = 0°C to +70°C	MAX6035AAUR				20	ppm/°C	
			MAX6035BAUR				50		
		T _A = -40°C to +85°C	MAX6035AAUR				25		
			MAX6035ESA				40		
		T _A = -40°C to +125°C	MAX6035BAUR				65		
			MAX6035AAUR				30		
Line Regulation (Note 4)	ΔV _{OUT} /ΔV _{IN}	(V _{OUT} + 2V) ≤ V _{IN} ≤ 33V	T _A = +25°C			4	μV/V		
			T _A = T _{MIN} to T _{MAX}			20			
Load Regulation (Note 4)	ΔV _{OUT} / ΔI _{OUT}	T _A = +25°C, MAX6035_AUR	Sourcing: 0 ≤ I _{OUT} ≤ 10mA			25	μV/mA		
			Sinking: -2mA ≤ I _{OUT} ≤ 0			45			
		T _A = T _{MIN} to T _{MAX} , MAX6035_AUR	Sourcing: 0 ≤ I _{OUT} ≤ 10mA			85			
			Sinking: -2mA ≤ I _{OUT} ≤ 0			225			
		T _A = +25°C, MAX6035ESA	Sourcing: 0 ≤ I _{OUT} ≤ 10mA			105		175	
			Sinking: -2mA ≤ I _{OUT} ≤ 0			205		375	
		T _A = T _{MIN} to T _{MAX} , MAX6035ESA	Sourcing: 0 ≤ I _{OUT} ≤ 10mA			350			
			Sinking: -2mA ≤ I _{OUT} ≤ 0			500			
		OUT Short-Circuit Current	I _{SC}	Short to GND				27	mA
				Short to IN				-4	

High-Supply-Voltage, Precision Voltage Reference in SOT23

MAX6035

ELECTRICAL CHARACTERISTICS—MAX6035_AUR25 and MAX6035ESA25 (2.5V) (continued)

($V_{IN} = 5V$, $I_{OUT} = 0$, $T_A = T_{MIN}$ to T_{MAX} , unless otherwise noted. Typical values are at $T_A = +25^\circ C$.) (Note 2)

PARAMETER	SYMBOL	CONDITIONS	MIN	TYP	MAX	UNITS
Dropout Voltage (Note 7)	$V_{IN} - V_{OUT}$	$I_{OUT} = 10\mu A$			1.9	V
		$I_{OUT} = 10mA$			2.25	
Thermal Hysteresis (Note 5)	$\Delta V_{OUT}/cycle$			135		ppm
Long-Term Stability	$\Delta V_{OUT}/time$	1000hr at $+25^\circ C$		110		ppm/ 1000hr
DYNAMIC CHARACTERISTICS						
Output Noise Voltage	e_n	$f = 0.1Hz$ to $10Hz$		21		μV_{P-P}
		$f = 10Hz$ to $1kHz$		20		μV_{RMS}
Ripple Rejection	$\Delta V_{OUT}/\Delta V_{IN}$	$V_{IN} = 5V \pm 100mV$, $f = 120Hz$		86		dB
Turn-On Settling Time	t_R	$T_o V_{OUT} = 0.1\%$ of final value	$C_{OUT} = 50pF$		35	μs
			$C_{OUT} = 1\mu F$		240	
Capacitive-Load Stability (Note 6)	C_{OUT}		0		5	μF
INPUT CHARACTERISTICS						
Supply Voltage Range	V_{IN}	Inferred from line regulation and dropout voltage	4.4		33	V
Quiescent Supply Current	I_{IN}			73	95	μA
Change in Supply Current	$\Delta I_{IN}/\Delta V_{IN}$	$4.4V \leq V_{IN} \leq 33V$		0.4	0.7	$\mu A/V$

ELECTRICAL CHARACTERISTICS—MAX6035_AUR30 (3.0V)

($V_{IN} = 5V$, $I_{OUT} = 0$, $T_A = T_{MIN}$ to T_{MAX} , unless otherwise noted. Typical values are at $T_A = +25^\circ C$.) (Note 2)

PARAMETER	SYMBOL	CONDITIONS	MIN	TYP	MAX	UNITS	
Output Voltage	V_{OUT}	$T_A = +25^\circ C$	MAX6035A (0.2%)	2.9940	3.0000	3.0060	V
			MAX6035B (0.5%)	2.9850	3.0000	3.0150	
Output Voltage Temperature Coefficient (Note 3)	TCV_{OUT}	$T_A = 0^\circ C$ to $+70^\circ C$	MAX6035A			20	ppm/ $^\circ C$
			MAX6035B			50	
		$T_A = -40^\circ C$ to $+85^\circ C$	MAX6035A			25	
			MAX6035B			65	
		$T_A = -40^\circ C$ to $+125^\circ C$	MAX6035A			30	
			MAX6035B			75	
Line Regulation (Note 4)	$\Delta V_{OUT}/\Delta V_{IN}$	$(V_{OUT} + 1.75V) \leq V_{IN} \leq 33V$	$T_A = +25^\circ C$		4.5	15	$\mu V/V$
			$T_A = 0^\circ C$ to $+125^\circ C$			24	
		$(V_{OUT} + 2V) \leq V_{IN} \leq 33V$	$T_A = -40^\circ C$ to $+125^\circ C$			24	
Load Regulation (Note 4)	$\Delta V_{OUT}/\Delta I_{OUT}$	$T_A = +25^\circ C$	Sourcing: $0 \leq I_{OUT} \leq 10mA$		30	81	$\mu V/mA$
			Sinking: $-2mA \leq I_{OUT} \leq 0mA$		54	170	
		$T_A = -40^\circ C$ to $+125^\circ C$	Sourcing: $0 \leq I_{OUT} \leq 10mA$			96	
			Sinking: $-2mA \leq I_{OUT} \leq 0mA$			230	

High-Supply-Voltage, Precision Voltage Reference in SOT23

ELECTRICAL CHARACTERISTICS—MAX6035_AUR30 (3.0V) (continued)

($V_{IN} = 5V$, $I_{OUT} = 0$, $T_A = T_{MIN}$ to T_{MAX} , unless otherwise noted. Typical values are at $T_A = +25^\circ C$.) (Note 2)

PARAMETER	SYMBOL	CONDITIONS		MIN	TYP	MAX	UNITS
OUT Short-Circuit Current	I _{SC}	Short to GND			27		mA
		Short to IN			-4		
Dropout Voltage (Note 7)	V _{IN} - V _{OUT}	T _A = 0°C to +125°C	I _{OUT} = 10μA			1.75	V
		T _A = -40°C to +125°C	I _{OUT} = 10μA			1.9	
			I _{OUT} = 10mA			2.25	
Thermal Hysteresis (Note 5)	ΔV _{OUT} /cycle				135		ppm
Long-Term Stability	ΔV _{OUT} /time	1000hr at +25°C			120		ppm/1000hr
DYNAMIC CHARACTERISTICS							
Output Noise Voltage	e _n	f = 0.1Hz to 10Hz			25		μV _{P-P}
		f = 10Hz to 1kHz			25		μV _{RMS}
Ripple Rejection	ΔV _{OUT} /ΔV _{IN}	V _{IN} = 5V ±100mV, f = 120Hz			80		dB
Turn-On Settling Time	t _R	V _{OUT} = 0.1% of final value	C _{OUT} = 50pF		40		μs
			C _{OUT} = 1μF		250		
Capacitive-Load Stability (Note 6)	C _{OUT}			0		5	μF
INPUT CHARACTERISTICS							
Supply Voltage Range	V _{IN}	T _A = 0°C to +125°C, inferred from line regulation and dropout voltage		4.75		33	V
		T _A = -40°C to +125°C, inferred from line regulation and dropout voltage		4.9		33	
Quiescent Current Supply	I _{IN}				73	95	μA
Change in Supply Current	ΔI _{IN} /ΔV _{IN}	4.9V ≤ V _{IN} ≤ 33V			0.4	0.7	μA/V

ELECTRICAL CHARACTERISTICS—MAX6035_AUR50 (5.0V)

($V_{IN} = 5V$, $I_{OUT} = 0$, $T_A = T_{MIN}$ to T_{MAX} , unless otherwise noted. Typical values are at $T_A = +25^\circ C$.) (Note 2)

PARAMETER	SYMBOL	CONDITIONS		MIN	TYP	MAX	UNITS
Output Voltage	V _{OUT}	T _A = +25°C	MAX6035A (0.2%)	4.9900	5.0000	5.0100	V
			MAX6035B (0.5%)	4.9750	5.0000	5.0250	
Output Voltage Temperature Coefficient (Note 3)	TCV _{OUT}	T _A = 0°C to +70°C	MAX6035A			20	ppm/°C
			MAX6035B			50	
		T _A = -40°C to +85°C	MAX6035A			25	
			MAX6035B			65	
		T _A = -40°C to +125°C	MAX6035A			30	
MAX6035B				75			
Line Regulation (Note 4)	ΔV _{OUT} /ΔV _{IN}	(V _{OUT} + 2V) ≤ V _{OUT} ≤ 33V	T _A = +25°C		7.5	25	μV/V
			T _A = -40°C to +125°C		8	40	

High-Supply-Voltage, Precision Voltage Reference in SOT23

MAX6035

ELECTRICAL CHARACTERISTICS—MAX6035_AUR50 (5.0V) (continued)

($V_{IN} = 5V$, $I_{OUT} = 0$, $T_A = T_{MIN}$ to T_{MAX} , unless otherwise noted. Typical values are at $T_A = +25^\circ C$.) (Note 2)

PARAMETER	SYMBOL	CONDITIONS	MIN	TYP	MAX	UNITS	
Load Regulation (Note 4)	$\Delta V_{OUT}/\Delta I_{OUT}$	$T_A = +25^\circ C$	Sourcing: $0 \leq I_{OUT} \leq 10mA$	50	135	$\mu V/mA$	
			Sinking: $-2mA \leq I_{OUT} \leq 0mA$	90	215		
		$T_A = -40^\circ C$ to $+125^\circ C$	Sourcing: $0 \leq I_{OUT} \leq 10mA$		160		
			Sinking: $-2mA \leq I_{OUT} \leq 0mA$		300		
OUT Short-Circuit Current	I _{SC}	Shorted to GND		27		mA	
		Shorted to I _N		-4			
Dropout Voltage (Note 7)	$V_{IN} - V_{OUT}$	$I_{OUT} = 10\mu A$			1.9	V	
		$I_{OUT} = 10mA$			2.25		
Thermal Hysteresis (Note 5)	$\Delta V_{OUT}/\text{cycle}$			135		ppm	
Long-Term Stability	$\Delta V_{OUT}/\text{time}$	1000hr at $+25^\circ C$		160		ppm/ 1000hr	
DYNAMIC CHARACTERISTICS							
Output Noise Voltage	e_n	$f = 0.1Hz$ to $10Hz$		68		μV_{P-P}	
		$f = 10Hz$ to $1kHz$		48		μV_{RMS}	
Ripple Rejection	$\Delta V_{OUT}/\Delta V_{IN}$	$V_{IN} = 15V \pm 100mV$, $f = 120Hz$		72		dB	
Turn-On Settling Time	t_R	To $V_{OUT} = 0.1\%$ of final value	$C_{OUT} = 50pF$	140		μs	
			$C_{OUT} = 1\mu F$	300			
Capacitive-Load Stability (Note 6)	C_{OUT}		0		5	μF	
INPUT CHARACTERISTICS							
Supply Voltage Range	V_{IN}	Inferred by line regulation and dropout voltage	6.9		33	V	
Quiescent Current Supply	I_{IN}			80	100	μA	
Change in Supply Current	$\Delta I_{IN}/\Delta V_{IN}$	$6.9V \leq V_{IN} \leq 33V$		0.4	0.7	$\mu A/V$	

Note 2: All devices are 100% production tested at $T_A = +25^\circ C$ and are guaranteed by design for $T_A = T_{MIN}$ to T_{MAX} , as specified.

Note 3: Temperature Coefficient is measured by the "box" method, i.e., the maximum ΔV_{OUT} is divided by the maximum ΔT .

Note 4: Line and load regulation are measured with pulses and do not include output voltage fluctuation due to die-temperature changes.

Note 5: Thermal Hysteresis is defined as the change in the output voltage at $T_A = +25^\circ C$ before and after cycling the device from T_{MAX} to T_{MIN} .

Note 6: Guaranteed by design.

Note 7: Although the source current is guaranteed to be 10mA, exercise caution to ensure that the package's absolute power dissipation rating is not exceeded.

High-Supply-Voltage, Precision Voltage Reference in SOT23

Typical Operating Characteristics

($V_{IN} = 5V$ for MAX6035AAUR25/MAX6035AAUR30, $V_{IN} = 15V$ for MAX6035AAUR50, $I_{OUT} = 0$, $T_A = +25^\circ C$, unless otherwise noted.)

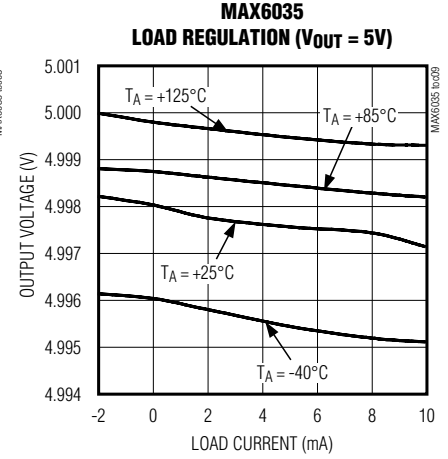
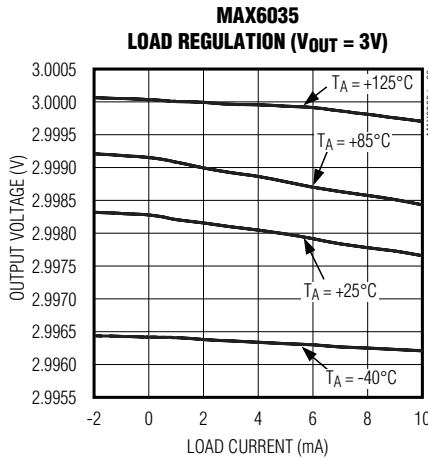
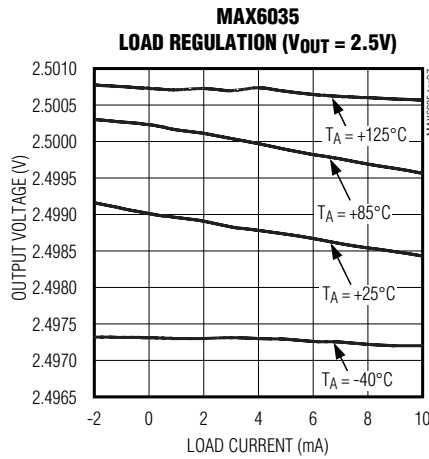
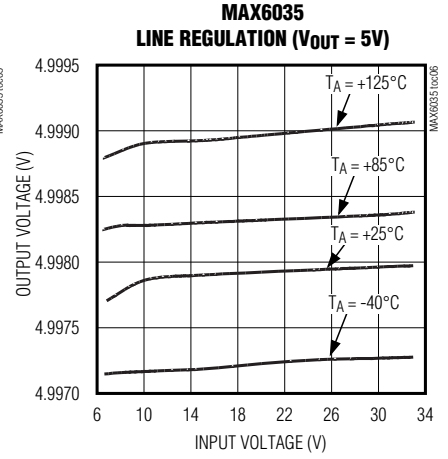
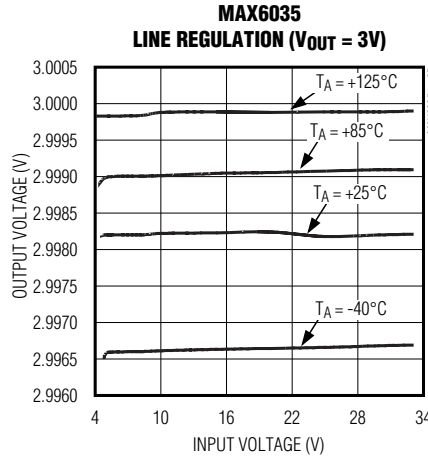
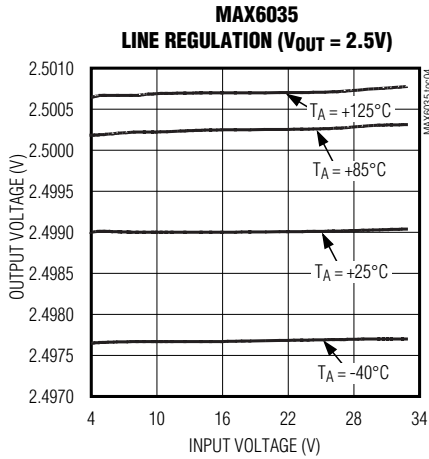
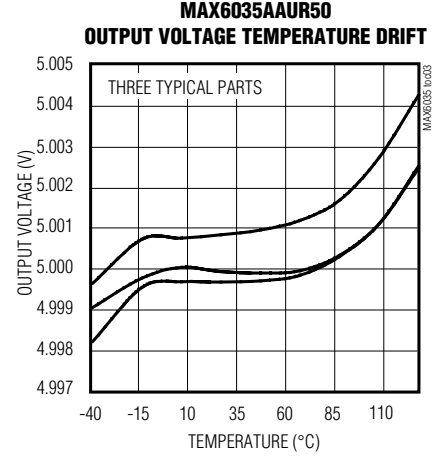
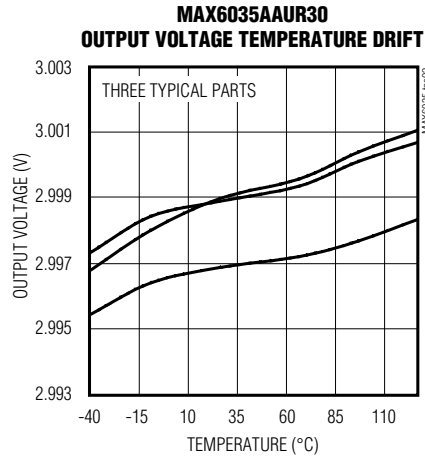
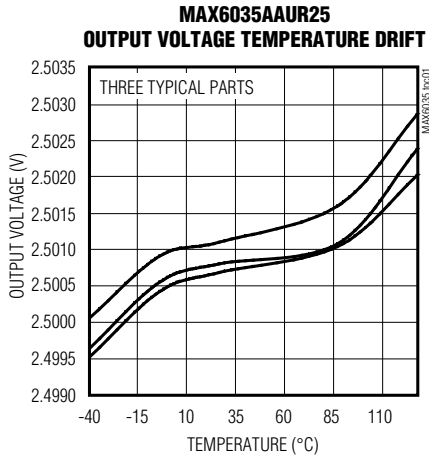

High-Supply-Voltage, Precision Voltage Reference in SOT23

Typical Operating Characteristics (continued)

($V_{IN} = 5V$ for MAX6035AAUR25/MAX6035AAUR30, $V_{IN} = 15V$ for MAX6035AAUR50, $I_{OUT} = 0$, $T_A = +25^\circ C$, unless otherwise noted.)

MAX6035

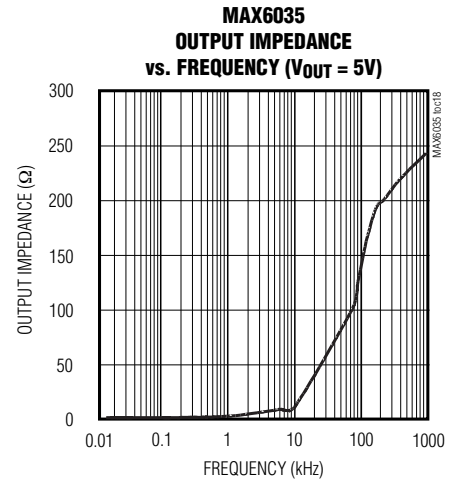
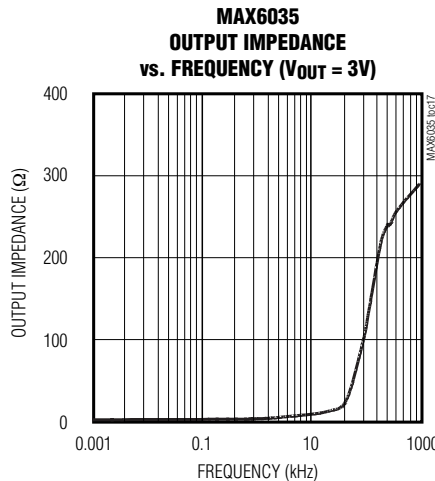
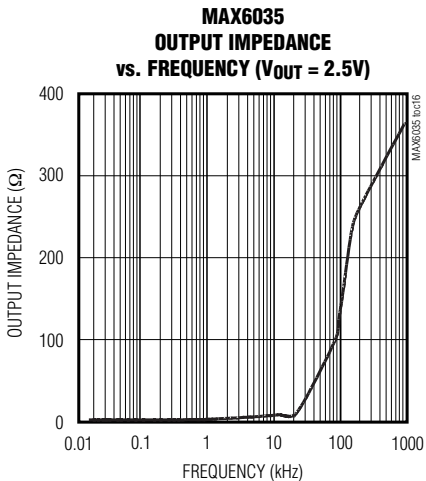
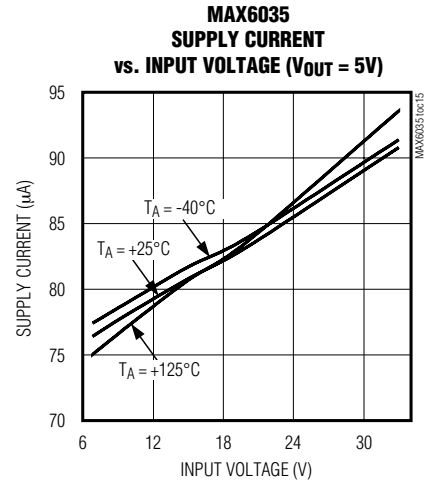
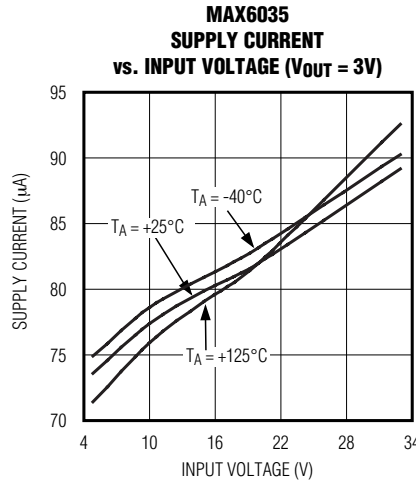
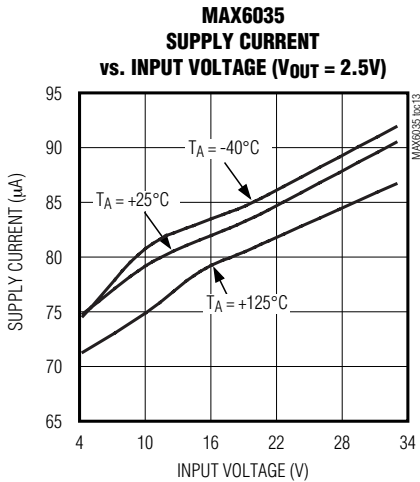
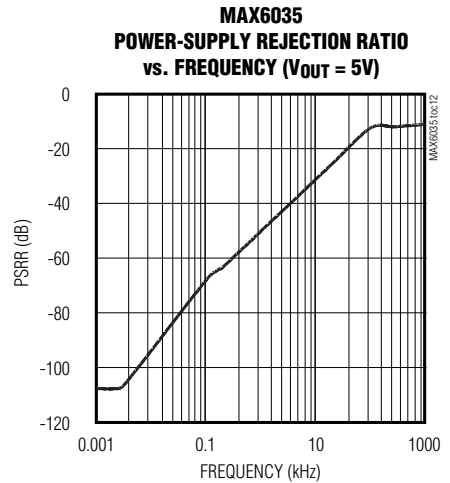
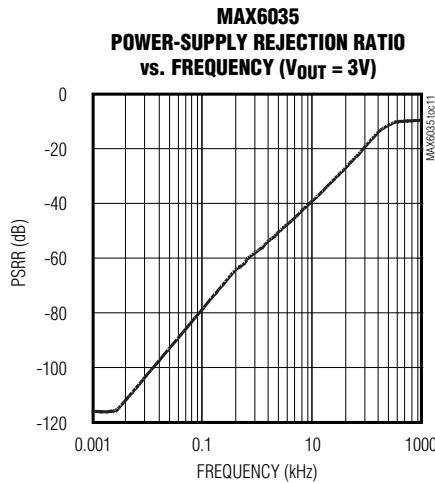
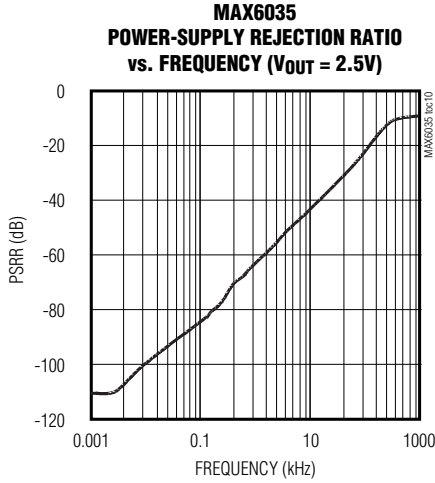

High-Supply-Voltage, Precision Voltage Reference in SOT23

Typical Operating Characteristics (continued)

($V_{IN} = 5V$ for MAX6035AAUR25/MAX6035AAUR30, $V_{IN} = 15V$ for MAX6035AAUR50, $I_{OUT} = 0$, $T_A = +25^\circ C$, unless otherwise noted.)

MAX6035
0.1Hz to 10Hz OUTPUT NOISE
($V_{OUT} = 2.5V$)

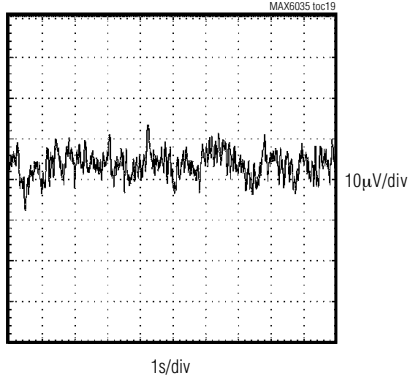

MAX6035
0.1Hz to 10Hz OUTPUT NOISE
($V_{OUT} = 3V$)

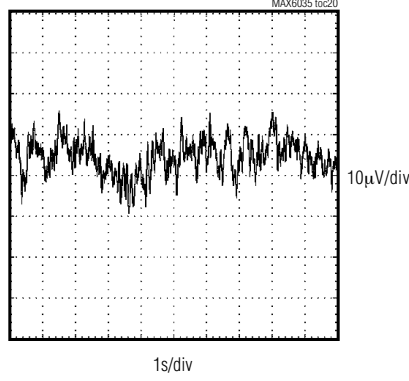

MAX6035
0.1Hz to 10Hz OUTPUT NOISE
($V_{OUT} = 5V$)

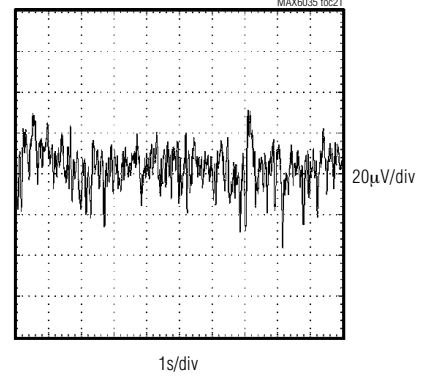

MAX6035
10Hz to 1kHz OUTPUT NOISE
($V_{OUT} = 2.5V$)

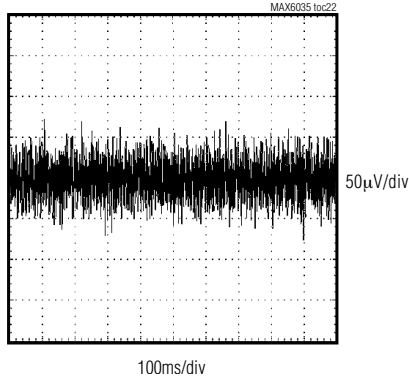

MAX6035
10Hz to 1kHz OUTPUT NOISE
($V_{OUT} = 3V$)

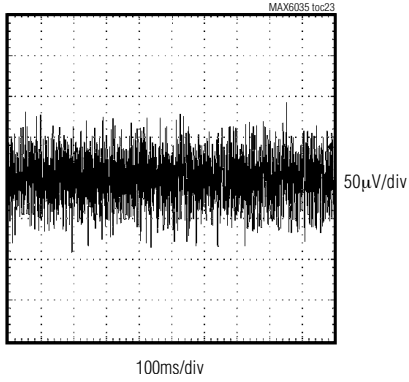

MAX6035
10Hz to 1kHz OUTPUT NOISE
($V_{OUT} = 5V$)

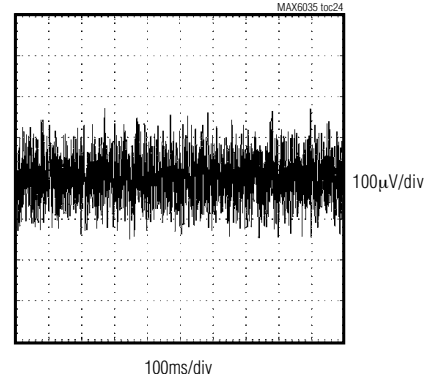

MAX6035
TURN-ON TRANSIENT ($V_{OUT} = 2.5V$)

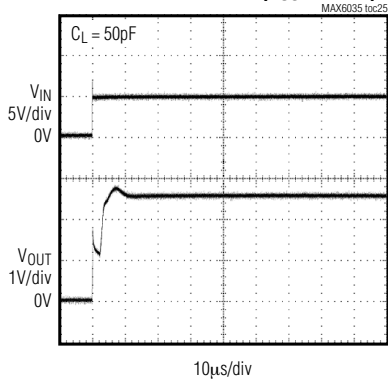

MAX6035
TURN-ON TRANSIENT ($V_{OUT} = 3V$)

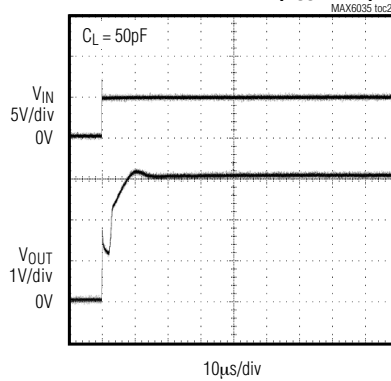

MAX6035
TURN-ON TRANSIENT ($V_{OUT} = 5V$)

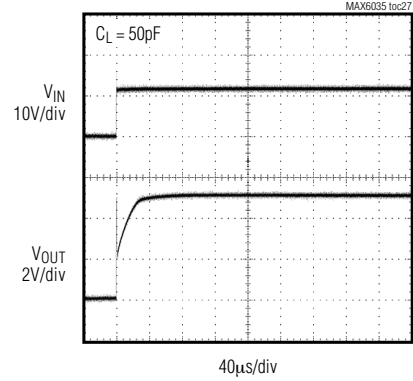

High-Supply-Voltage, Precision Voltage Reference in SOT23

MAX6035

Typical Operating Characteristics (continued)

($V_{IN} = 5V$ for MAX6035AAUR25/MAX6035AAUR30, $V_{IN} = 15V$ for MAX6035AAUR50, $I_{OUT} = 0$, $T_A = +25^\circ C$, unless otherwise noted.)

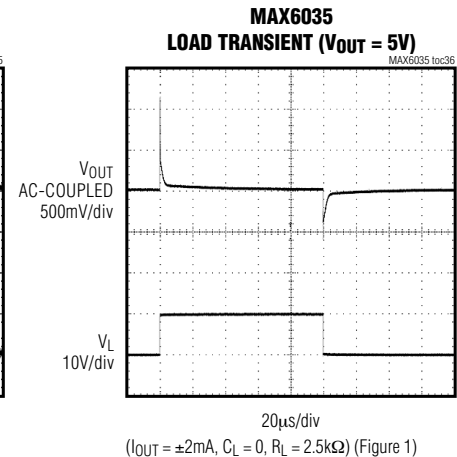
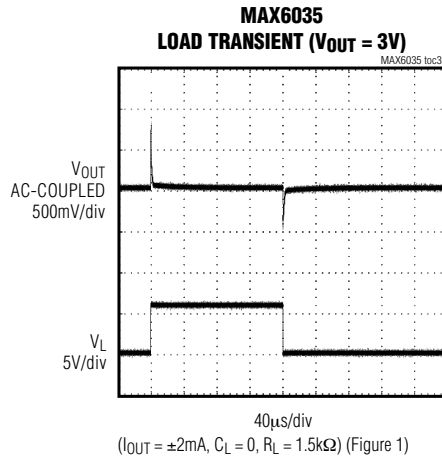
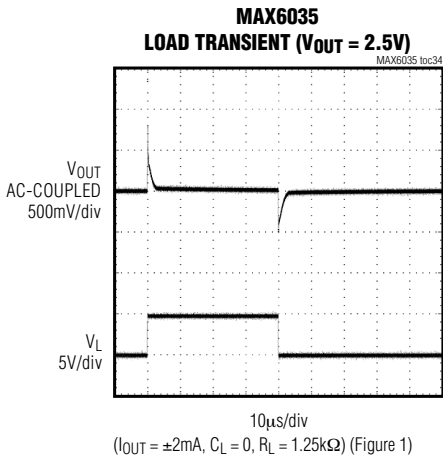
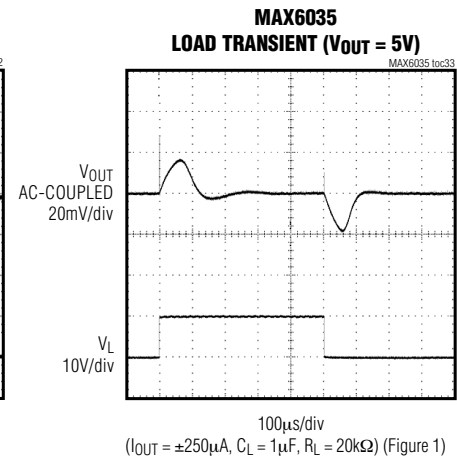
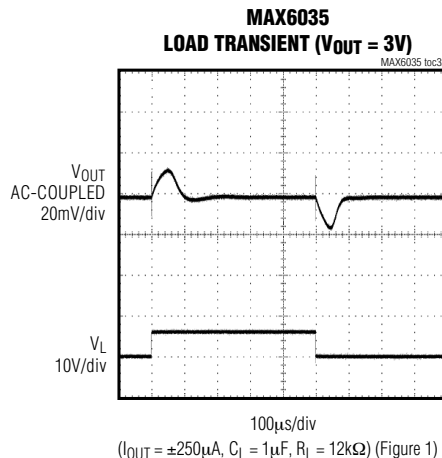
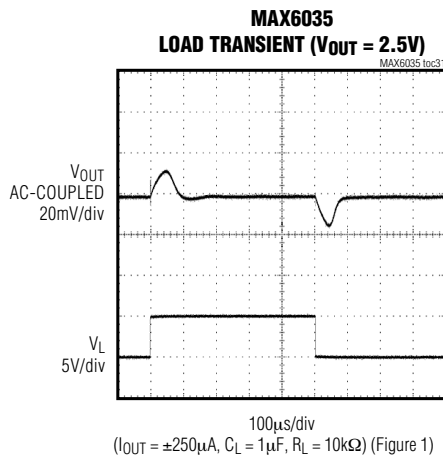
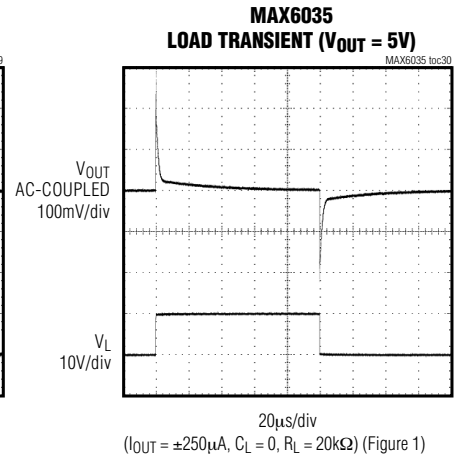
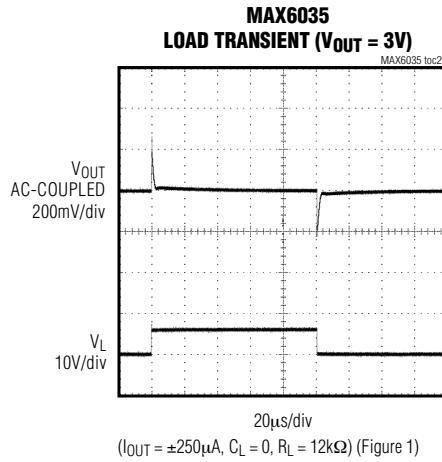
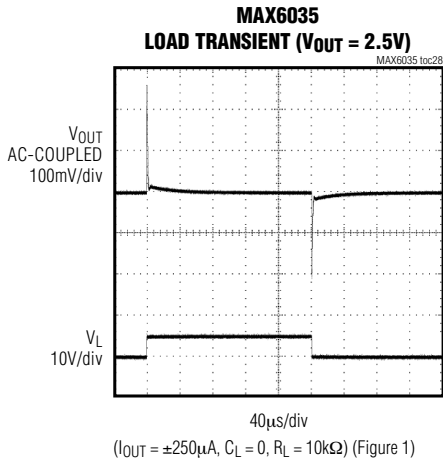

High-Supply-Voltage, Precision Voltage Reference in SOT23

MAX6035

Typical Operating Characteristics (continued)

($V_{IN} = 5V$ for MAX6035AAUR25/MAX6035AAUR30, $V_{IN} = 15V$ for MAX6035AAUR50, $I_{OUT} = 0$, $T_A = +25^\circ C$, unless otherwise noted.)

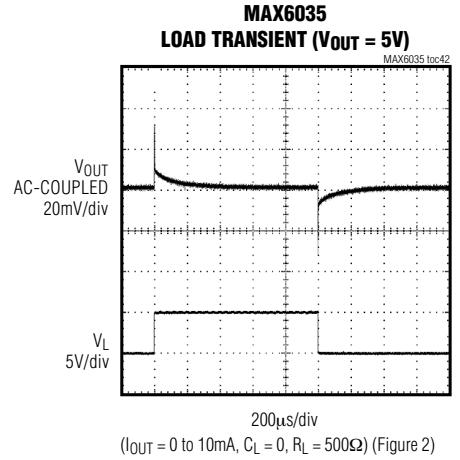
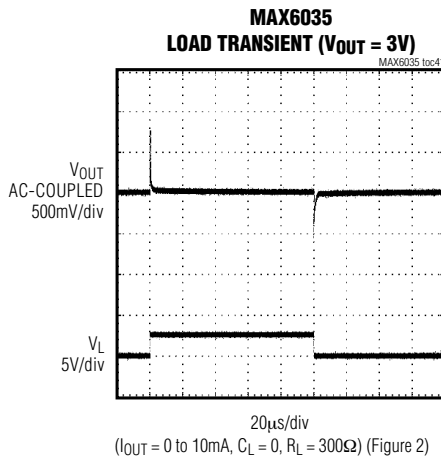
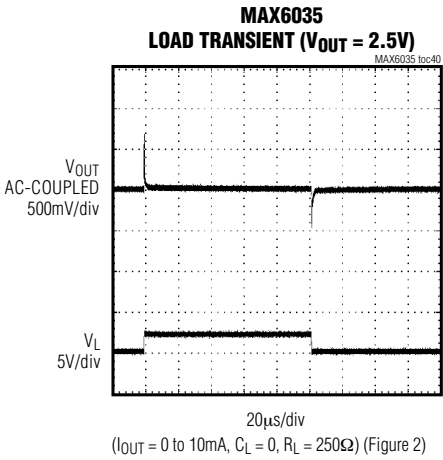
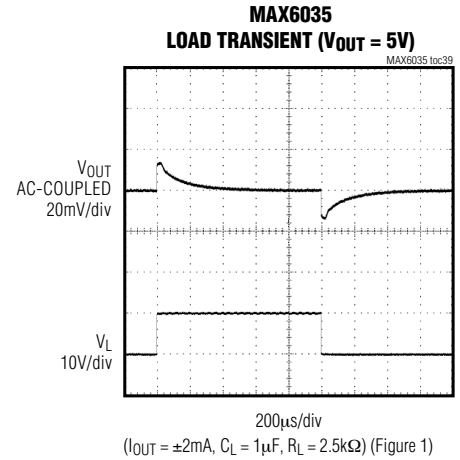
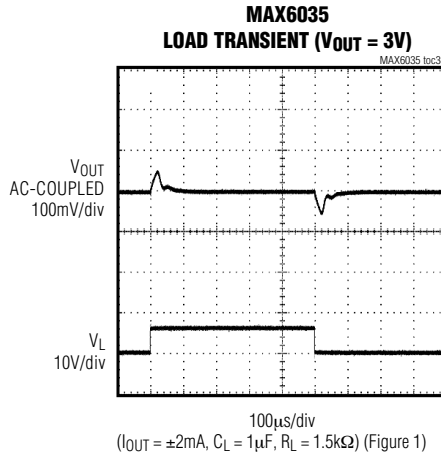
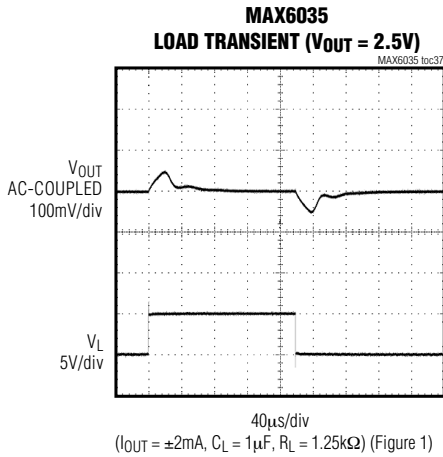

High-Supply-Voltage, Precision Voltage Reference in SOT23

MAX6035

Typical Operating Characteristics (continued)

($V_{IN} = 5V$ for MAX6035AAUR25/MAX6035AAUR30, $V_{IN} = 15V$ for MAX6035AAUR50, $I_{OUT} = 0$, $T_A = +25^\circ C$, unless otherwise noted.)

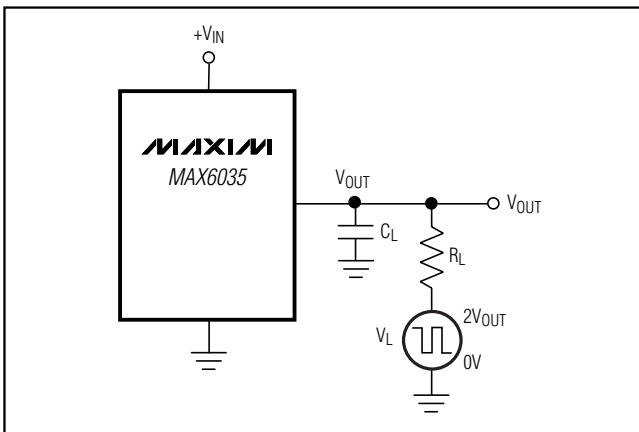
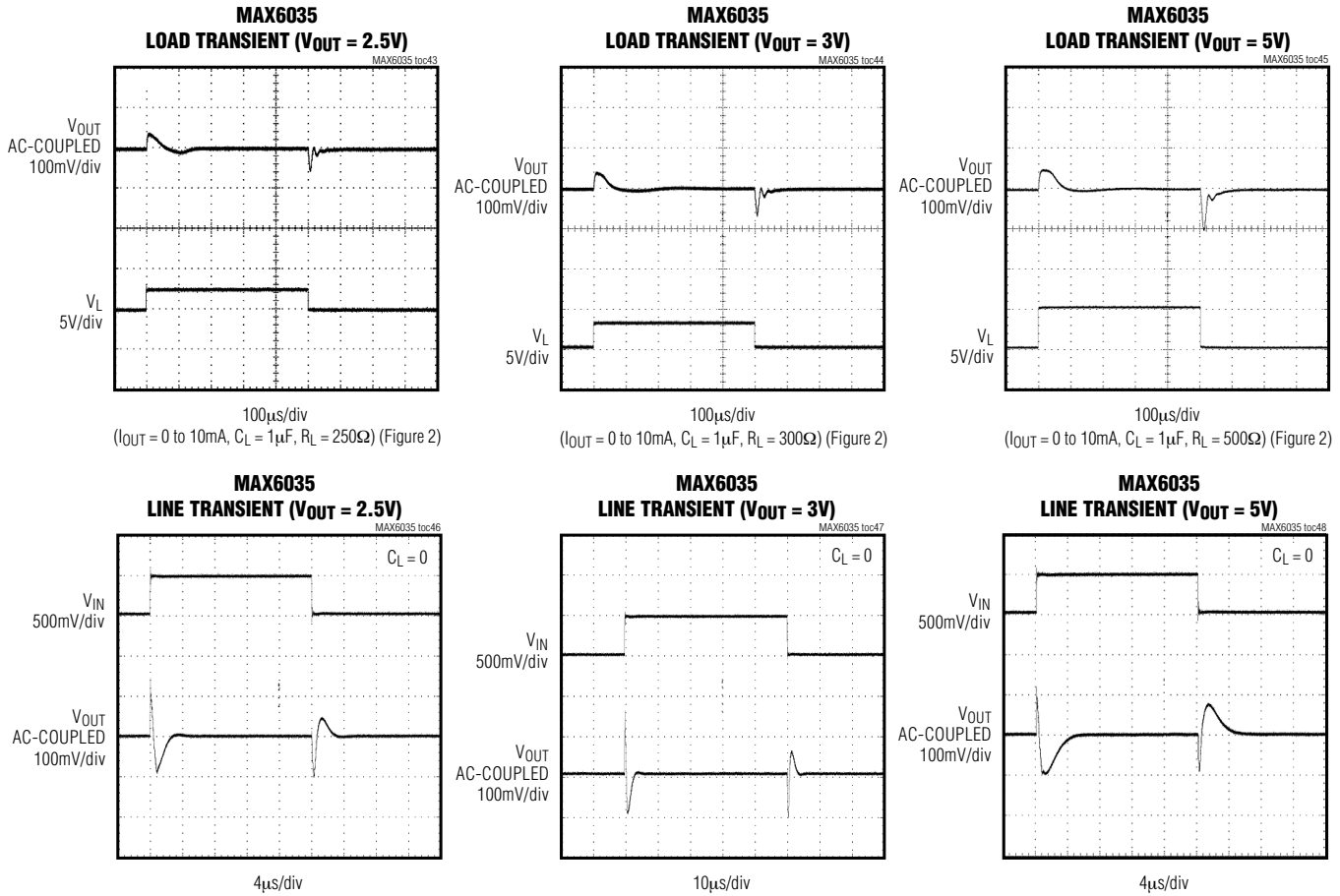

Figure 1. Load-Transient Test Circuit

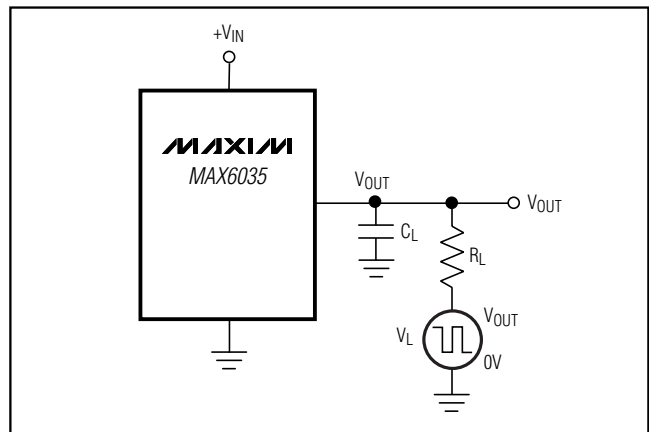

Figure 2. Load-Transient Test Circuit

High-Supply-Voltage, Precision Voltage Reference in SOT23

Pin Description

PIN		NAME	FUNCTION
SOT23	SO		
1	2	IN	Input Voltage
2	6	OUT	Reference Output
3	4	GND	Ground
	1, 3, 5, 7, 8	N.C.	No Connection. Not internally connected.

Applications Information

Input Bypassing

For the best line-transient performance, decouple the input with a 0.1 μ F ceramic capacitor as shown in the *Typical Operating Circuit*. Locate the capacitor as close to the device as possible. Where transient performance is less important, no capacitor is necessary.

Output/Load Capacitance

Devices in the MAX6035 family do not require any output capacitance for frequency stability. In applications where the load or the supply can experience step changes, an output capacitor of at least 0.1 μ F reduces the amount of overshoot (undershoot) and improves the circuit's transient response. Many applications do not require an external capacitor, and the MAX6035 family can offer a significant advantage in these applications when board space is critical.

Supply Current

The quiescent supply current of the MAX6035 series-mode family is typically 73 μ A and is virtually independent of the supply voltage, with only a 0.7 μ A/V (max) variation with supply voltage. In contrast, the quiescent current of a shunt-mode reference is a function of the input voltage due to a series resistor connected to the

power supply. Additionally, shunt-mode references have to be biased at the maximum expected load current, even if the load current is not present at the time. In the MAX6035 family, the load current is drawn from the input voltage only when required, so supply current is not wasted and efficiency is maximized at all input voltages. This improved efficiency reduces power dissipation and extends battery life.

Thermal Hysteresis

Thermal hysteresis is the change of output voltage at $T_A = +25^\circ\text{C}$ before and after the device is cycled over its entire operating temperature range. The typical temperature hysteresis value is 135ppm.

Turn-On Time

These devices typically turn on and settle to within 0.1% of their final value in 240 μ s. Increased output capacitance also increases turn-on time.

Temperature Coefficient vs. Operating Temperature Range for a 1 LSB Maximum Error

In a data converter application, the reference voltage of the converter must stay within a certain limit to keep the error in the data converter smaller than the resolution limit through the operating temperature range. Figure 3 shows the maximum allowable reference-voltage temperature coefficient to keep the conversion error to less than 1LSB, as a function of the operating temperature range ($T_{MAX} - T_{MIN}$) with the converter resolution as a parameter. The graph assumes the reference-voltage temperature coefficient as the only parameter affecting accuracy.

In reality, the absolute static accuracy of a data converter is dependent on the combination of many parameters such as integral nonlinearity, differential nonlinearity, offset error, gain error, as well as voltage reference changes

High-Supply-Voltage, Precision Voltage Reference in SOT23

MAX6035

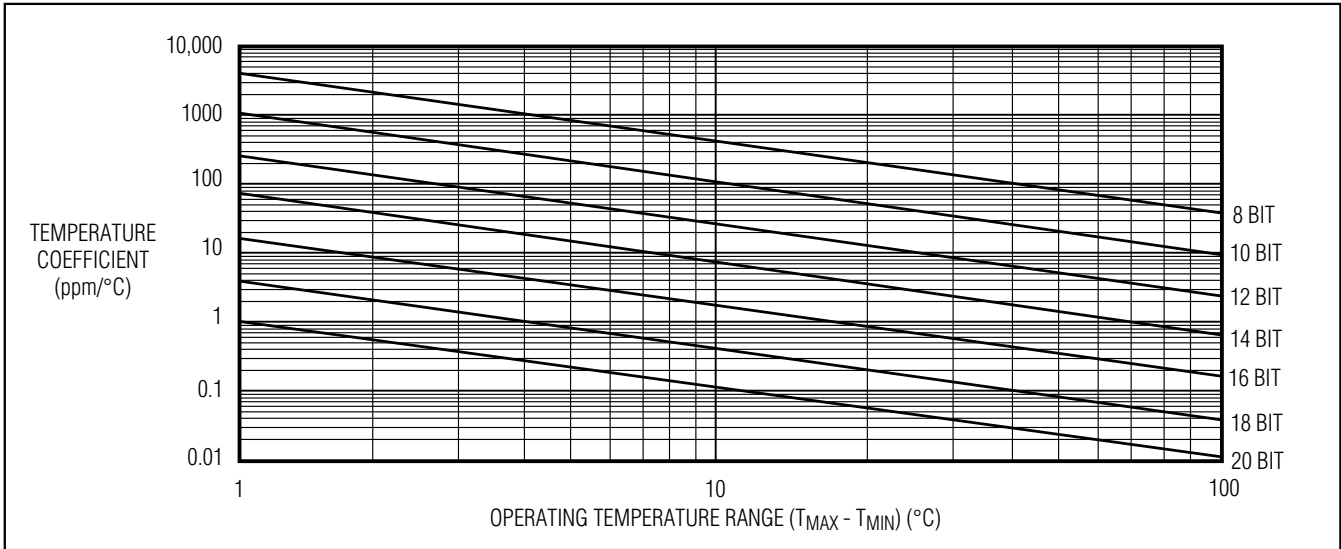

Figure 3. Temperature Coefficient vs. Operating Temperature Range for a 1 LSB Maximum Error

Chip Information

TRANSISTOR COUNT: 84
 PROCESS: BiCMOS

High-Supply-Voltage, Precision Voltage Reference in SOT23

Package Information

(The package drawing(s) in this data sheet may not reflect the most current specifications. For the latest package outline information, go to www.maxim-ic.com/packages.

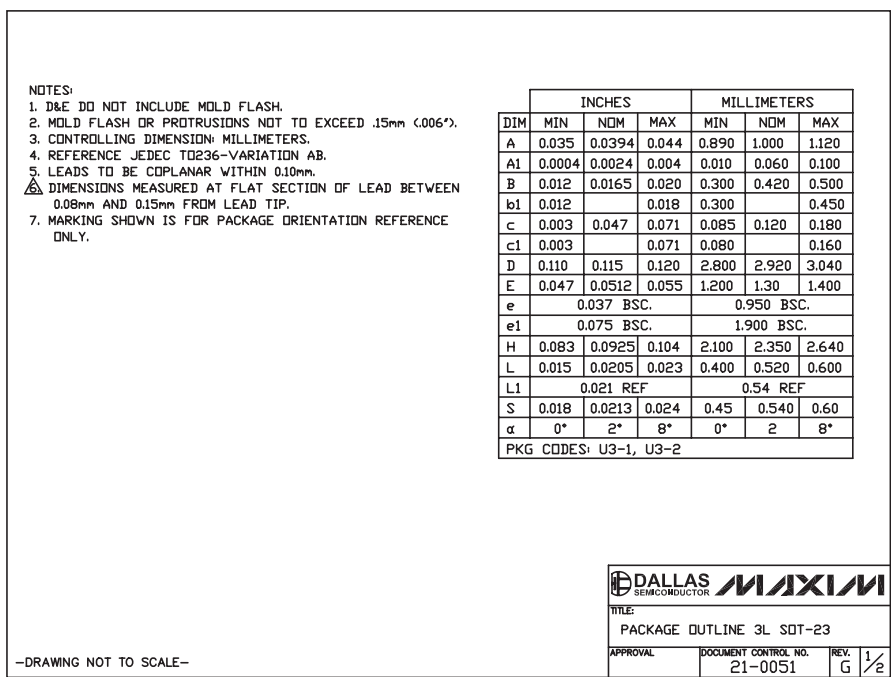
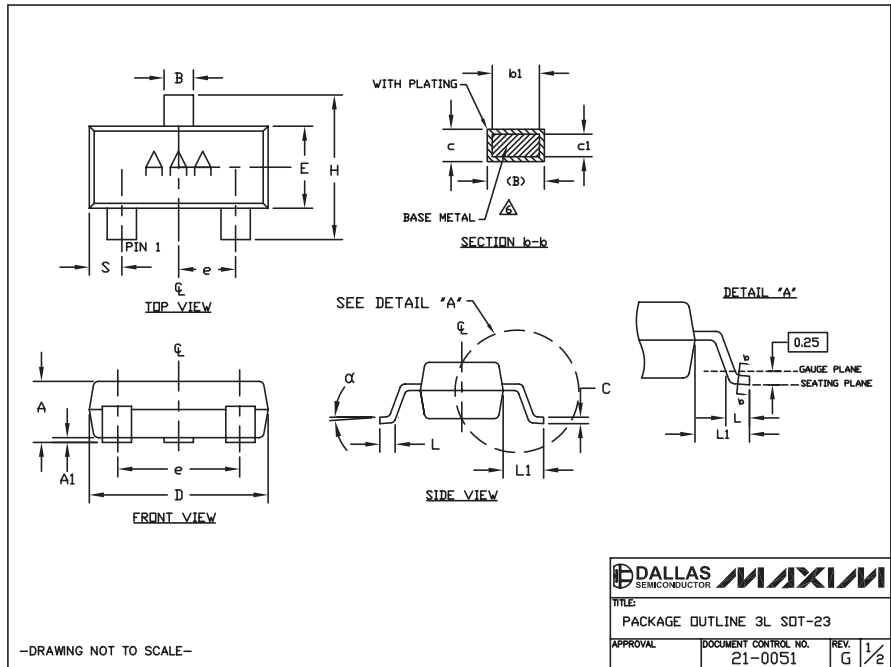

High-Supply-Voltage, Precision Voltage Reference in SOT23

Package Information (continued)

(The package drawing(s) in this data sheet may not reflect the most current specifications. For the latest package outline information go to www.maxim-ic.com/packages.)

MAX6035

SOICN, EPS

DIM	INCHES		MILLIMETERS	
	MIN	MAX	MIN	MAX
A	0.053	0.069	1.35	1.75
A1	0.004	0.010	0.10	0.25
B	0.014	0.019	0.35	0.49
C	0.007	0.010	0.19	0.25
e	0.050 BSC		1.27 BSC	
E	0.150	0.157	3.80	4.00
H	0.228	0.244	5.80	6.20
L	0.016	0.050	0.40	1.27

VARIATIONS:

DIM	INCHES		MILLIMETERS		N	MS012
	MIN	MAX	MIN	MAX		
D	0.189	0.197	4.80	5.00	8	AA
D	0.337	0.344	8.55	8.75	14	AB
D	0.386	0.394	9.80	10.00	16	AC

NOTES:

1. D&E DO NOT INCLUDE MOLD FLASH.
2. MOLD FLASH OR PROTRUSIONS NOT TO EXCEED 0.15mm (.006").
3. LEADS TO BE COPLANAR WITHIN 0.10mm (.004").
4. CONTROLLING DIMENSION: MILLIMETERS.
5. MEETS JEDEC MS012.
6. N = NUMBER OF PINS.

DALLAS SEMICONDUCTOR		MAXIM	
PROPRIETARY INFORMATION			
TITLE: PACKAGE OUTLINE, .150" SOIC			
APPROVAL	DOCUMENT CONTROL NO. 21-0041	REV. B	1/1

Revision History

Pages changed at Rev 2: 1, 2, 3, 12, 15

Pages changed at Rev 3: 1, 2, 15

Maxim cannot assume responsibility for use of any circuitry other than circuitry entirely embodied in a Maxim product. No circuit patent licenses are implied. Maxim reserves the right to change the circuitry and specifications without notice at any time.

Maxim Integrated Products, 120 San Gabriel Drive, Sunnyvale, CA 94086 408-737-7600 _____ 15

© 2006 Maxim Integrated Products

MAXIM is a registered trademark of Maxim Integrated Products, Inc.