

Click [here](#) to ask about the production status of specific part numbers.

MAX17227A

400mV to 5.5V Input, 2A nanoPower Boost Converter with Short-Circuit Protection and True Shutdown

General Description

The MAX17227A is a nanoPower boost converter capable of delivering load up to 2A peak inductor current and offering True Shutdown™, cycle-by-cycle inductor current limit, short-circuit, and thermal protection. During shutdown, current drawn from the input pin is 1nA. The MAX17227A offers ultra-low quiescent current, small total solution size, and high efficiency throughout the load and line range. The MAX17227A is ideal for battery-powered applications where long battery life is a must and high efficiency is required at all power levels.

The MAX17227A utilizes adjustable on-time, pulse-frequency-modulation (PFM) control scheme that consumes ultra-low quiescent current. The MAX17227A features True Shutdown mode where the output disconnects from the input with no forward or reverse-current. This saves precious energy from the battery for systems that dynamically turn on and off by having the ability to startup into a precharged output capacitor.

The MAX17227A is offered in a space-saving and cost-effective 1.58mm x 0.89mm, 6-bump WLP (3 x 2, 0.4mm pitch) and 8-pin, 2mm x 2mm TDFN packages. The operating temperature range is from -40°C to +125°C.

Applications

- Consumer
 - WiFi Module
 - Near-Band IoT
 - Wearable Audio
- Industrial
 - Emergency Lighting
 - IoT Sensors
- Medical
 - Clinical Instrumentation

Benefits and Features

- 350nA Quiescent Supply Current from Output
- Output Short-Circuit Protection
- True Shutdown Mode
 - 1nA Shutdown Current
 - Output Disconnects from Input
 - No Reverse-Current with Any Voltage on V_{OUT}
- 96% Peak Efficiency, 90% or Higher at 500µA
- Typical 850mA Output Current at 5.0V (V_{IN} = 3.0V)
- 400mV to 5.5V Input Range, Up to 5.35V in Regulation
- 880mV Minimum Startup Voltage
- Single Resistor-Adjustable Output Voltage
 - 2.3V to 5.2V Output Voltage Range with 100mV Steps
 - 5.5V Output Voltage Setting Available
- 2A Peak Inductor Current Limit
- Thermal Shutdown Protection
- Multiple Package Options
 - 1.58mm x 0.89mm, 0.4mm Pitch, 6-Bump (3 x 2) WLP
 - 2mm x 2mm, 8-Pin TDFN
- -40°C to +125°C Operating Temperature Range

[Ordering Information](#) appears at end of data sheet.

True Shutdown is a trademark of Maxim Integrated Products, Inc.



MAX17227A

400mV to 5.5V Input, 2A nanoPower Boost Converter with Short-Circuit Protection and True Shutdown

Typical Operating Circuit

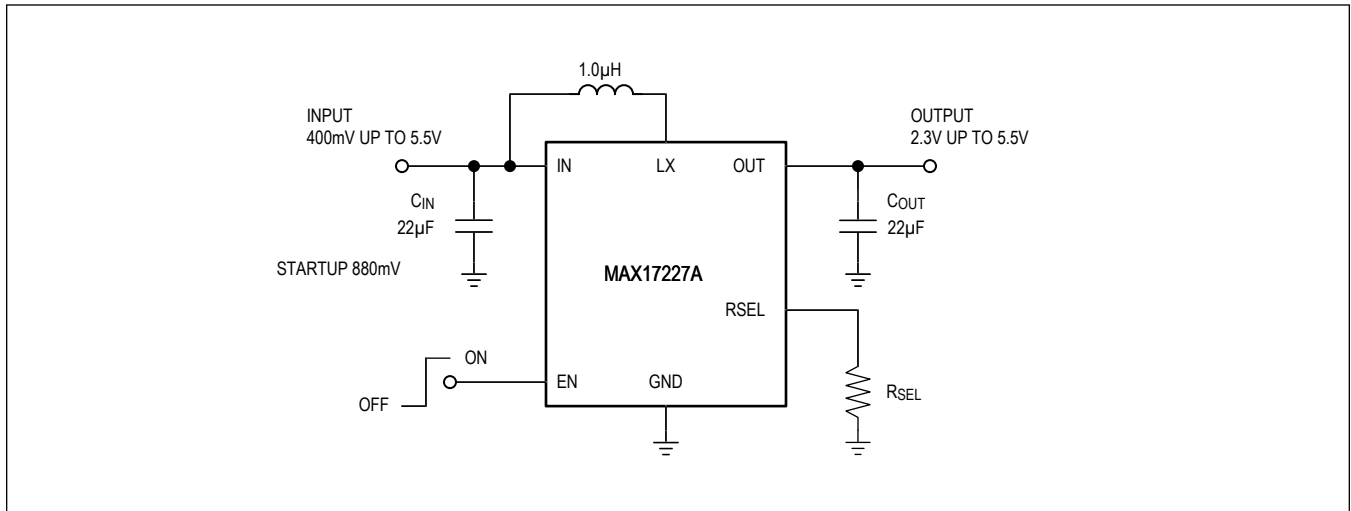

TABLE OF CONTENTS

General Description	1
Applications	1
Benefits and Features	1
Typical Operating Circuit	2
Absolute Maximum Ratings	6
Package Information	6
TDFN	6
WLP	6
Electrical Characteristics	7
Typical Operating Characteristics	9
Pin Configurations	11
WLP	11
TDFN	12
Pin Description	12
Functional Diagrams	13
Detailed Description	14
Control Scheme	14
Output Voltage Selection	16
Fixed-Output Voltage Version	18
Features	18
Enable	18
Soft-Start Control	18
Short-Circuit Protection	18
Thermal Shutdown	18
Design Procedure	19
Inductor Selection	19
Input Capacitor	19
Output Capacitor	19
PCB Layout Guidelines	19
Thermal Considerations	19
Ordering Information	21
Revision History	22

LIST OF FIGURES

Figure 1. ULPM, LPM, HPM Transition Waveforms 15
Figure 2. LPM, HPM, ULPM Transition Waveforms 16

MAX17227A

400mV to 5.5V Input, 2A nanoPower Boost
Converter with Short-Circuit Protection and True
Shutdown

LIST OF TABLES

Table 1. R_{SEL} Selection Table 17

MAX17227A

400mV to 5.5V Input, 2A nanoPower Boost Converter with Short-Circuit Protection and True Shutdown

Absolute Maximum Ratings

IN, EN, RSEL, OUT to GND	-0.3V to +6V	Continuous Power Dissipation - TDFN (T _A = +70°C) (Derate 11.7mW/°C above 70°C)	937.9mW
LX RMS Current	-1.6A _{RMS} to +1.6A _{RMS}	Operating Junction Temperature Range	-40°C to +125°C
IN RMS Current	-0.8A _{RMS} to +0.8A _{RMS}	Maximum Junction Temperature	+150°C
LX to GND	-0.3V to V _{OUT} + 0.3V ⁽¹⁾	Storage Temperature Range	-65°C to +150°C
Output Short-Circuit Duration	Continuous	Soldering Temperature (reflow)	+260°C
Continuous Power Dissipation - WLP (T _A = +70°C) (Derate 10.51mW/°C above +70°C)	840mW		

Note 1: LX pin has internal clamps to GND and OUT. These diodes may be forward biased during switching transitions. During these transitions, the max LX current should be within the Max RMS Current rating for safe operation.

Stresses beyond those listed under "Absolute Maximum Ratings" may cause permanent damage to the device. These are stress ratings only, and functional operation of the device at these or any other conditions beyond those indicated in the operational sections of the specifications is not implied. Exposure to absolute maximum rating conditions for extended periods may affect device reliability.

Package Information

TDFN

Package Code	T822+3C
Outline Number	21-0168
Land Pattern Number	90-0065
Thermal Resistance, Four-Layer Board:	
Junction to Ambient (θ _{JA})	85.3°C/W
Junction to Case (θ _{JC})	8.9°C/W

WLP

Package Code	N60O1+1
Outline Number	21-100390
Land Pattern Number	Refer to Application Note 1891
Thermal Resistance, Four-Layer Board:	
Junction to Ambient (θ _{JA})	95.15°C/W
Junction to Case (θ _{JC})	N/A

For the latest package outline information and land patterns (footprints), go to www.maximintegrated.com/packages. Note that a "+", "#", or "-" in the package code indicates RoHS status only. Package drawings may show a different suffix character, but the drawing pertains to the package regardless of RoHS status.

Package thermal resistances were obtained using the method described in JEDEC specification JESD51-7, using a four-layer board. For detailed information on package thermal considerations, refer to www.maximintegrated.com/thermal-tutorial.

Electrical Characteristics

($V_{IN} = 1.5V$, $R_{SEL} = 191k\Omega$, $V_{OUT} = 3.3V$, $T_J = -40^\circ C$ to $+125^\circ C$, typical values are at $T_J = +25^\circ C$, $C_{IN} = 22\mu F$, $C_{OUT} = 22\mu F$, unless otherwise noted.) (Note 2)

PARAMETER	SYMBOL	CONDITIONS		MIN	TYP	MAX	UNITS
Minimum Input Voltage	V_{IN_MIN}	Runs from output after startup, $I_{OUT} = 1mA$			400		mV
Input Voltage Range	V_{IN}	Guaranteed by LX Maximum On-Time, $V_{OUT} > V_{IN} + 150mV$ while in regulation		0.95		5.5	V
Minimum Startup Input Voltage	V_{IN_START}	$R_L \geq 3k\Omega$, Typical Operating Circuit , $T_J = +25^\circ C$			0.88	0.95	V
Output Voltage Range	V_{OUT_RANGE}	See Table 1 . For $V_{IN} < V_{OUT}$ target. (Note 3)		2.3		5.5	V
Output Accuracy, LPM	V_{ACC_LPM}	V_{OUT} Falling (Note 4)		-1		+1	%
Output Accuracy, ULPM	V_{ACC_ULPM}	V_{OUT} Rising, when LX stops switching (Note 5)		+1.5	+2.7	+4.6	%
DC Load Regulation	ACC_{LOAD}	Load from 20mA to I_{OUT} at 80% of Peak Inductor Current			-1		%
DC Line Regulation	ACC_{LINE}	Duty Cycle varied from 25% to Maximum			-1		%
Input Shutdown Current	I_{SD_IN}	$V_{EN} = 0V$, $V_{OUT} = 0V$, $T_J = +25^\circ C$			1	100	nA
Quiescent Supply Current Into IN	I_{Q_IN}	$V_{EN} = V_{IN}$, not switching, $V_{OUT} = 105\%$ of target voltage, $T_J = +25^\circ C$, $R_{SEL} = Open$			12		nA
Quiescent Supply Current Into OUT	I_{Q_OUT}	$V_{EN} = V_{IN}$, not switching, $V_{OUT} = 105\%$ of target voltage, $T_J = +25^\circ C$, $R_{SEL} = Open$			350	660	nA
Maximum LX On-Time	t_{ONMAX}	$T_J = -40^\circ C$ to $+125^\circ C$		1.0	1.75	2.2	μs
LX On-Time in CCM	$t_{ON_1.2V}$	$V_{IN} = 1.2V$	$T_J = +25^\circ C$	580	620	660	ns
			$T_J = -40^\circ C$ to $+125^\circ C$	500	620	740	
	$t_{ON_3.0V}$	$V_{IN} = 3.0V$	$T_J = +25^\circ C$	240	300	360	
LX Maximum Duty Cycle	DC	$R_{SEL} = 10k\Omega$, $V_{IN} = 1.2V$, $T_J = +25^\circ C$ (Note 6)		80	86		%
		$R_{SEL} = 10k\Omega$, $V_{IN} = 1.2V$ (Note 6)		74	86		
		$R_{SEL} = 191k\Omega$, $V_{IN} = 3.0V$ (Note 6)		65	75		
LX Leakage Current	I_{LEAK_LX}	$V_{LX} = V_{IN} = 5.5V$, $V_{OUT} = V_{EN} = 0V$	$T_J = +25^\circ C$		1	100	nA
IN Current Limit	I_{IN_PT}	$V_{IN} = V_{EN} = 3.3V$, $V_{OUT} = 2.3V$			1.1		A
Inductor Peak Current Limit	I_{PEAK_LX}	$V_{OUT} = 3.3V$, (Note 7)	$T_J = +25^\circ C$	1.9	2.0	2.1	A
		$V_{OUT} = 3.3V$	$T_J = -40^\circ C$ to $+125^\circ C$	1.8	2.0	2.2	
High-Side $R_{DS(on)}$	R_{DS_H}	$V_{OUT} = 3.3V$			95	160	$m\Omega$
Low-Side $R_{DS(on)}$	R_{DS_L}	$V_{OUT} = 3.3V$			50	90	$m\Omega$
Zero Crossing Threshold	I_{ZX_LX}	(Note 7)		25	50	75	mA
Soft Start Rate	t_{SS_RATE}	Target $V_{OUT} = 5.0V$			3		V/ms
Enable Input Leakage	I_{LEAK_EN}	$T_J = +25^\circ C$, $V_{EN} = 5.5V$			0.3	100	nA

Electrical Characteristics (continued)

($V_{IN} = 1.5V$, $R_{SEL} = 191k\Omega$, $V_{OUT} = 3.3V$, $T_J = -40^\circ C$ to $+125^\circ C$, typical values are at $T_J = +25^\circ C$, $C_{IN} = 22\mu F$, $C_{OUT} = 22\mu F$, unless otherwise noted.) (*Note 2*)

PARAMETER	SYMBOL	CONDITIONS	MIN	TYP	MAX	UNITS
Enable Voltage Threshold	V_{EN_IH}	V_{EN} Rising, LX begins switching		0.6	0.95	V
	V_{EN_IL}	V_{EN} Falling, LX stops switching	0.15	0.55		
Required Select Resistor Accuracy	ACC_{RSEL}	Note: Use the resistor from Table 1 .	-1		+1	%
Select Resistor Detection Time	t_{RSEL}	$C_{RSEL} < 2pF$ (<i>Note 8</i>)	240	600	1320	μs
Thermal Shutdown Threshold	T_{SHUT}	OUT disabled		165		$^\circ C$
				150		

Note 2: Limits over the specified operating temperature and supply voltage range are guaranteed by design and characterization, and production tested at room temperature only.

Note 3: Guaranteed by the Required Select Resistor Accuracy parameter.

Note 4: Output Accuracy in Low-Power mode when $I_{OUT} > I_{OUT_TRANSITION}$ and inductor current is not in Continuous Conduction mode. This accuracy does not include load, line, or ripple.

Note 5: Output Accuracy in Ultra-Low-Power mode when $I_{OUT} < I_{OUT_TRANSITION}$. This accuracy does not include load, line, or ripple.

Note 6: Guaranteed by measuring LX frequency and duty cycle. Maximum duty cycle is a function of input voltage since LX on time varies with V_{IN} .

Note 7: This is static measurement. The actual peak current limit depends on V_{IN} and L due to propagation delays.

Note 8: This is the time required to acquire the R_{SEL} value. This time adds to the startup time.

Typical Operating Characteristics

(MAX17227AANT+, $I_{IN} = 1.5V$, $V_{OUT} = 3.3V$, $L = 1.0\mu H$, $C_{IN} = 22\mu F$, $C_{OUT} = 22\mu F$, $T_A = +25^\circ C$, unless otherwise noted.)

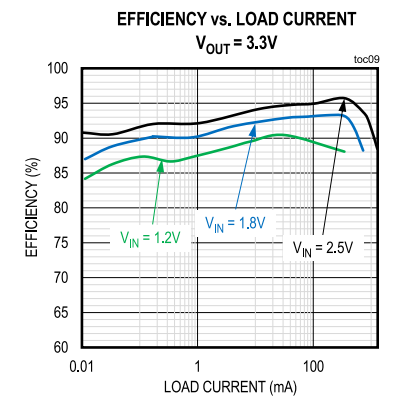
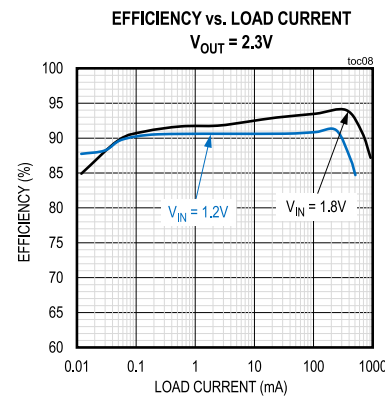
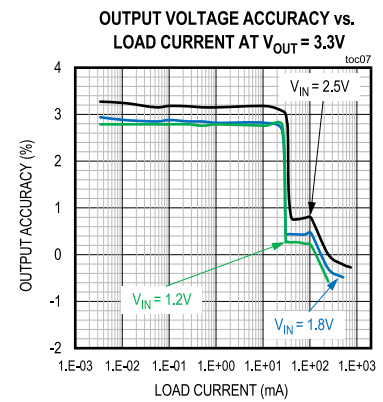
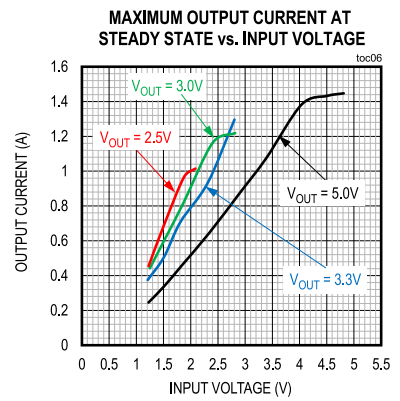
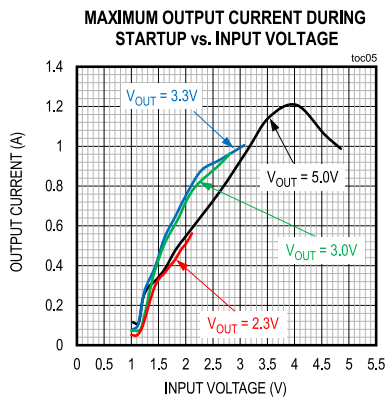
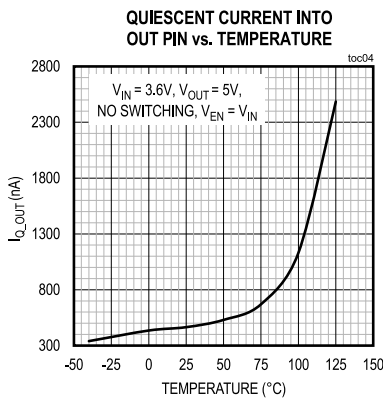
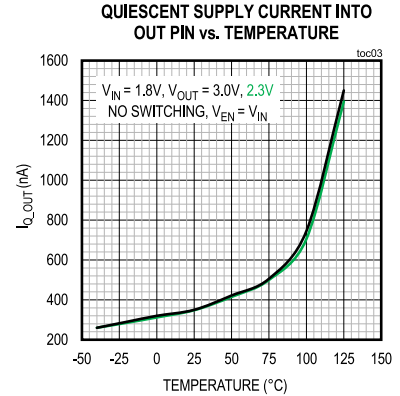
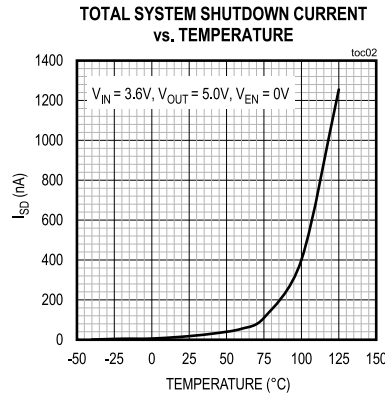
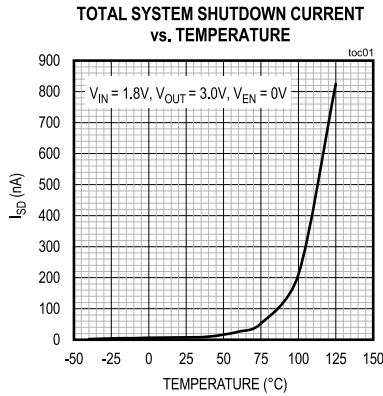

Typical Operating Characteristics (continued)

(MAX17227AANT+, $I_{IN} = 1.5V$, $V_{OUT} = 3.3V$, $L = 1.0\mu H$, $C_{IN} = 22\mu F$, $C_{OUT} = 22\mu F$, $T_A = +25^\circ C$, unless otherwise noted.)

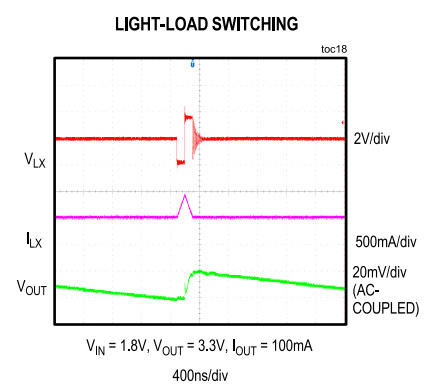
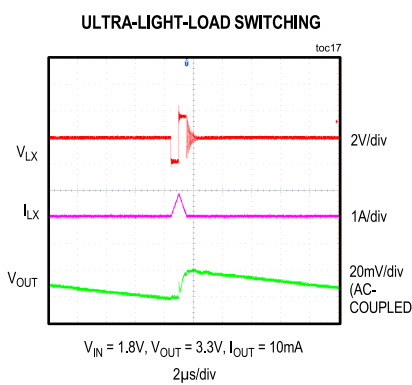
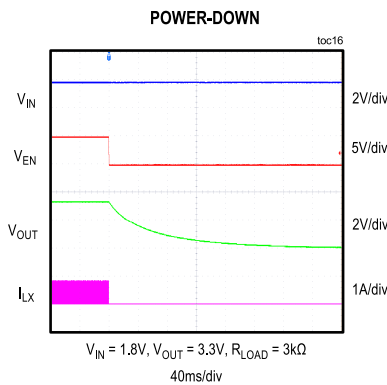
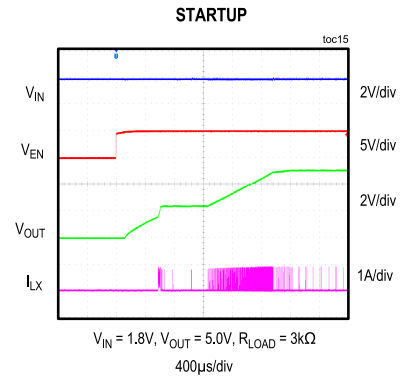
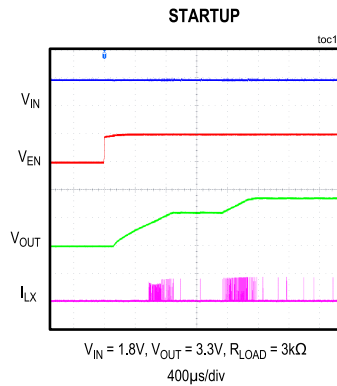
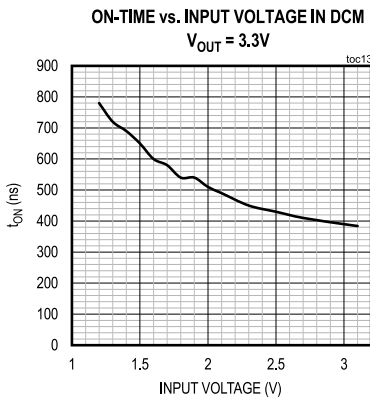
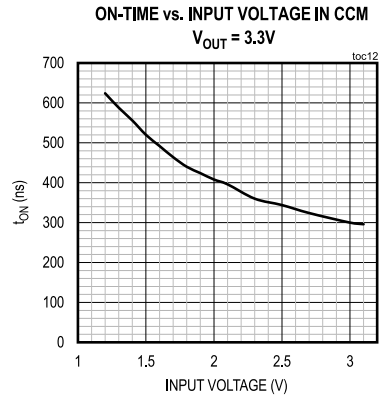
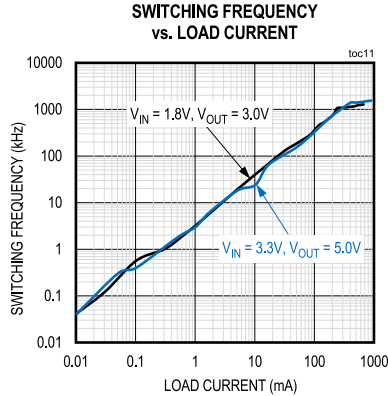
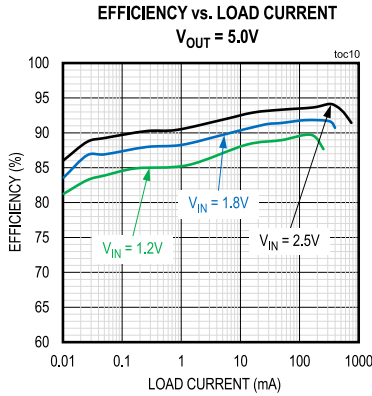

MAX17227A

400mV to 5.5V Input, 2A nanoPower Boost Converter with Short-Circuit Protection and True Shutdown

Typical Operating Characteristics (continued)

(MAX17227AANT+, IN = 1.5V, OUT = 3.3V, L = 1.0μH, C_{IN} = 22μF, C_{OUT} = 22μF, T_A = +25°C, unless otherwise noted.)

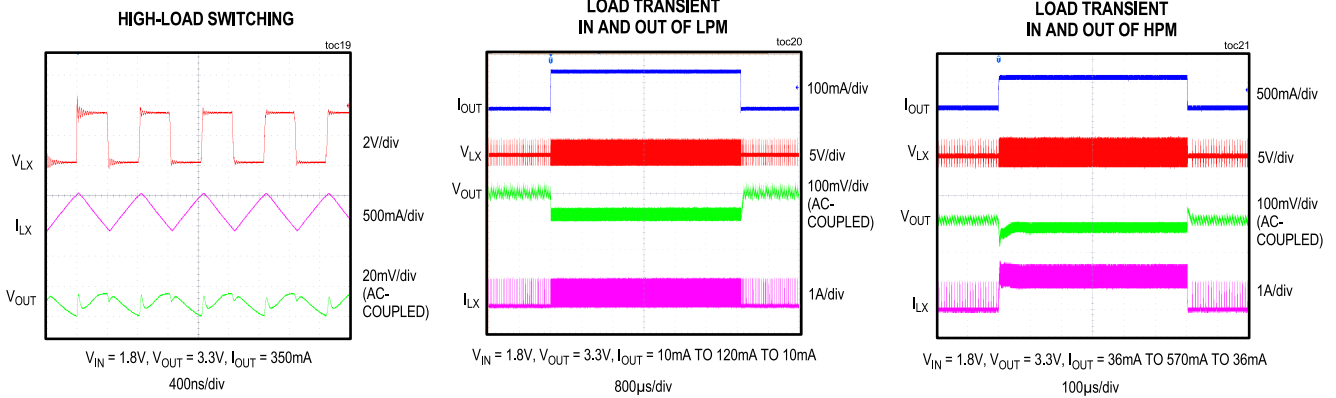

Pin Configurations

WLP

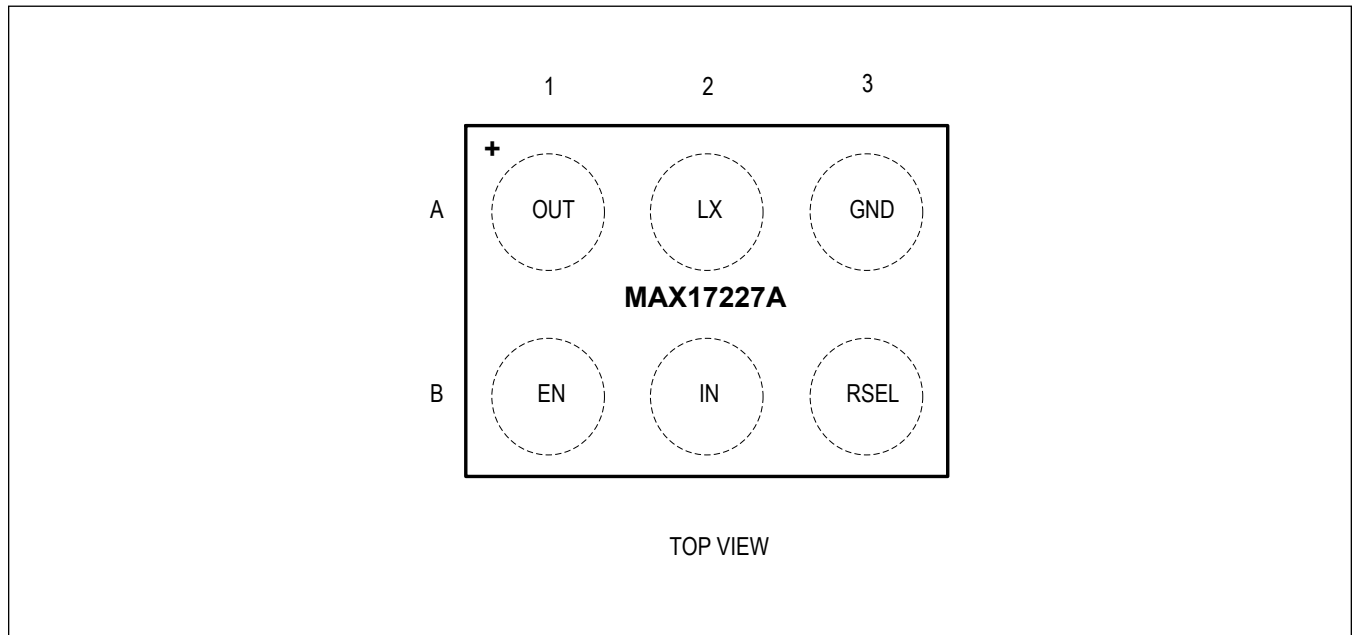

MAX17227A

400mV to 5.5V Input, 2A nanoPower Boost Converter with Short-Circuit Protection and True Shutdown

TDFN

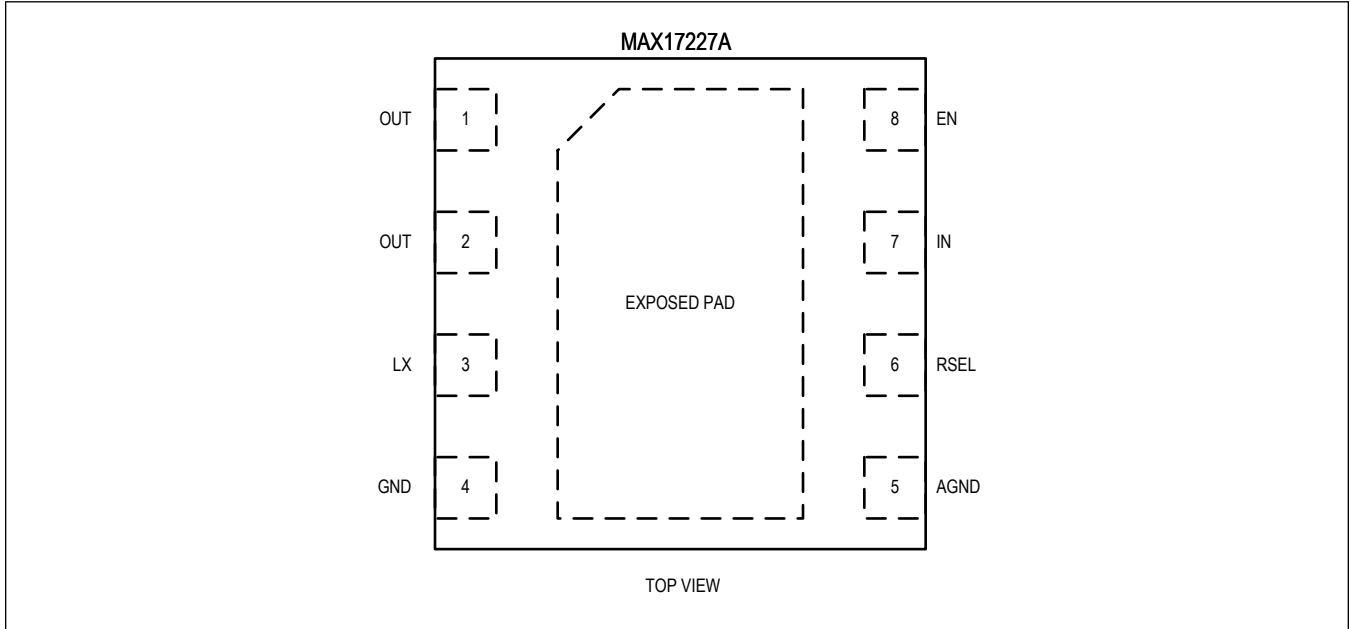

Pin Description

PIN		NAME	FUNCTION
WLP	TDFN		
A1	1, 2	OUT	Output Pins. Connect a 22 μ F X7R ceramic capacitor to ground.
A2	3	LX	Switching Node. Connect a 1.0 μ H inductor from LX to IN.
A3	4	GND	Power Ground Pin. Connect to GND. In the TDFN package, applications connect to the exposed pad (EP) externally in the PCB layout at a single point.
—	5	AGND	Analog Ground Pin. Connect to the EP externally in the PCB layout at a single point.
B3	6	RSEL	Output Voltage Select Pin. Connect a resistor from RSEL to GND based on the desired output voltage. See Table 1 . RSEL floats in shutdown. Care must be taken that the total capacitance on this pin should be less than 2pF. See PCB Layout Guidelines for more information.
B2	7	IN	Input Pin. Connect a 22 μ F X7R ceramic capacitor to ground. Depending on the specific application requirements, more capacitance may be needed.
B1	8	EN	Enable Input Pin. Force this pin to larger than 0.6V to enable the boost converter. Force this pin below 0.55V to disable the part and enter the True Shutdown mode.
—	EP	EP	Exposed Pad. Connect the EP to GND. Functionally connected to AGND. Connect the GND and AGND pins to EP externally in the PCB layout with short traces under the device.

MAX17227A

400mV to 5.5V Input, 2A nanoPower Boost Converter with Short-Circuit Protection and True Shutdown

Functional Diagrams

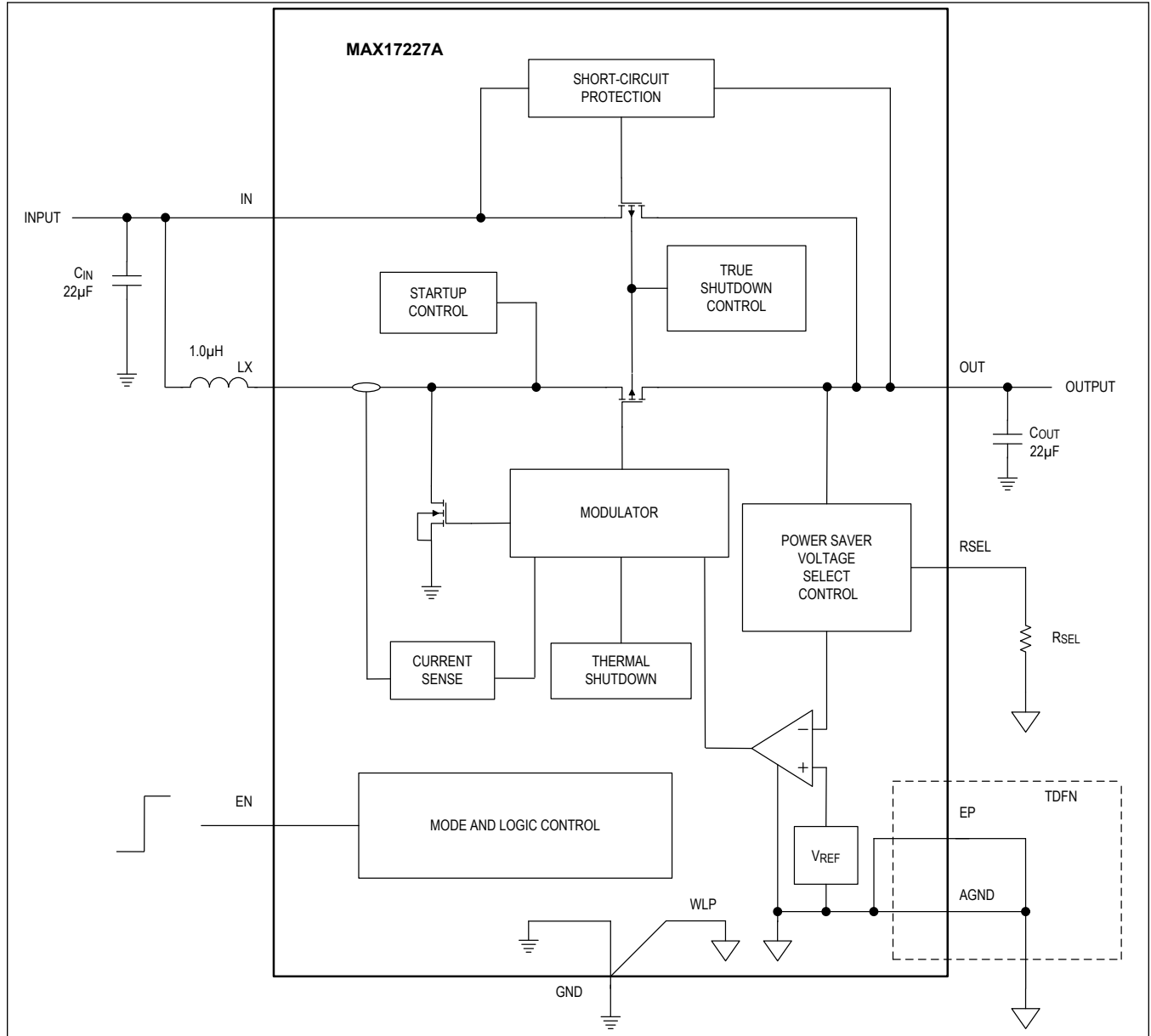

Detailed Description

The MAX17227A is an ultra-low I_Q synchronous step-up converter optimized for battery-powered systems requiring long battery running time, high efficiency across wide load range, and small solution size. The device can operate across a wide input voltage ranging from 0.4V to 5.5V. The MAX17227A consumes only 350nA of current, output referred while in regulation. The output voltage is programmed in the range between 2.3V to 5.2V with 100mV resolution using a single resistor connected from the RSEL pin to ground. 5.4V and 5.5V output target levels are available. However, the device does not support ultra-low-power mode when the target output voltage is either 5.4V or 5.5V.

The MAX17227A utilizes an adaptive on-time pulse frequency modulation (PFM) control scheme that allows ultra-low quiescent current and high efficiency over a wide output current range. The peak inductor current is set by on-time or by cycle-by-cycle 2A current limit. The device provides the True Shutdown feature where the load is completely disconnected from the input minimizing leakage current. The MAX17227A features short-circuit and thermal protection.

Control Scheme

The MAX17227A boost converter is controlled by a unique, adaptive on-time pulse frequency modulation scheme that allows very high-efficiency operation across full load current range. The MAX17227A automatically switches between the Ultra-Low-Power mode (ULPM), Low-Power mode (LPM) and High-Power mode (HPM) of operation, depending on the load current. [Figure 1](#) and [Figure 2](#) show typical waveforms while in each mode. On-time is a function of V_{IN} with typical performance shown in [Typical Operating Characteristics](#).

The output voltage is regulated 2.7% higher while in ULPM (V_{ACC_ULPM}). This reduces the effective skip frequency significantly improving the system efficiency. In addition, operating marginally above the regulation threshold, the device has an excellent transient response when a large load transient event occurs. The device will typically be in ULPM when the system is in standby state. Once the output voltage exceeds the ULPM regulation level, the device will go into sleep mode, consuming very low quiescent current. It will wake up to resume switching when the output voltage falls below the threshold. While in this mode, the device will regulate output while consuming only 350nA of current. Such a low current consumption translates into great performance, achieving 90% efficiency at 10 μ A load current.

The MAX17227A will transition to LPM once the load current is high enough that it forces the device to switch faster than 17 μ s. The load current level at which this transition happens is a function on the operating condition and component selection. The user can calculate the value of the load current where ULPM transitions to LPM using the equation below.

$$I_{OUT_TRANSITION} = \left(\frac{t_{ON}}{2 \times L} \right)^2 \times \left(\frac{V_{IN}}{\frac{V_{OUT}}{V_{IN}} - 1} \right) \times \left(\frac{\eta}{17 \mu s} \right)$$

For example, for $V_{IN} = 1.2V$, $V_{OUT} = 3V$ and $L = 1.0\mu H$, assuming 85% efficiency the UPLM to LPM transition current happens at approximately 11.3mA.

The MAX17227A enters HPM when the inductor current transitions from DCM to CCM. The inductor current ripple will be reduced in the CCM operation in order to assure proper mode transitions. The voltage is regulated by an error amplifier that compares the output voltage to the internal reference and adjusts inductor current accordingly achieving great load regulation performance of 1%.

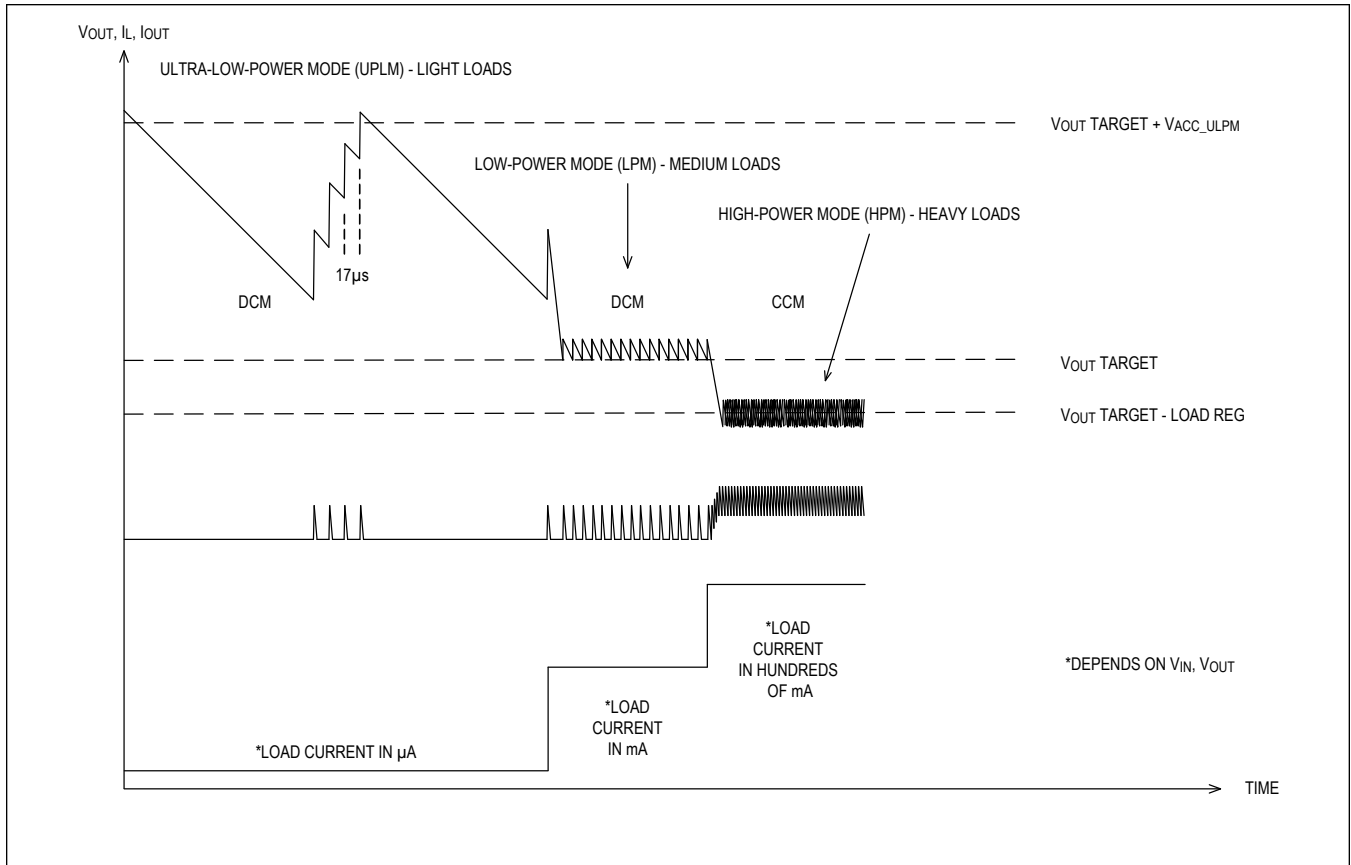

Figure 1. ULPM, LPM, HPM Transition Waveforms

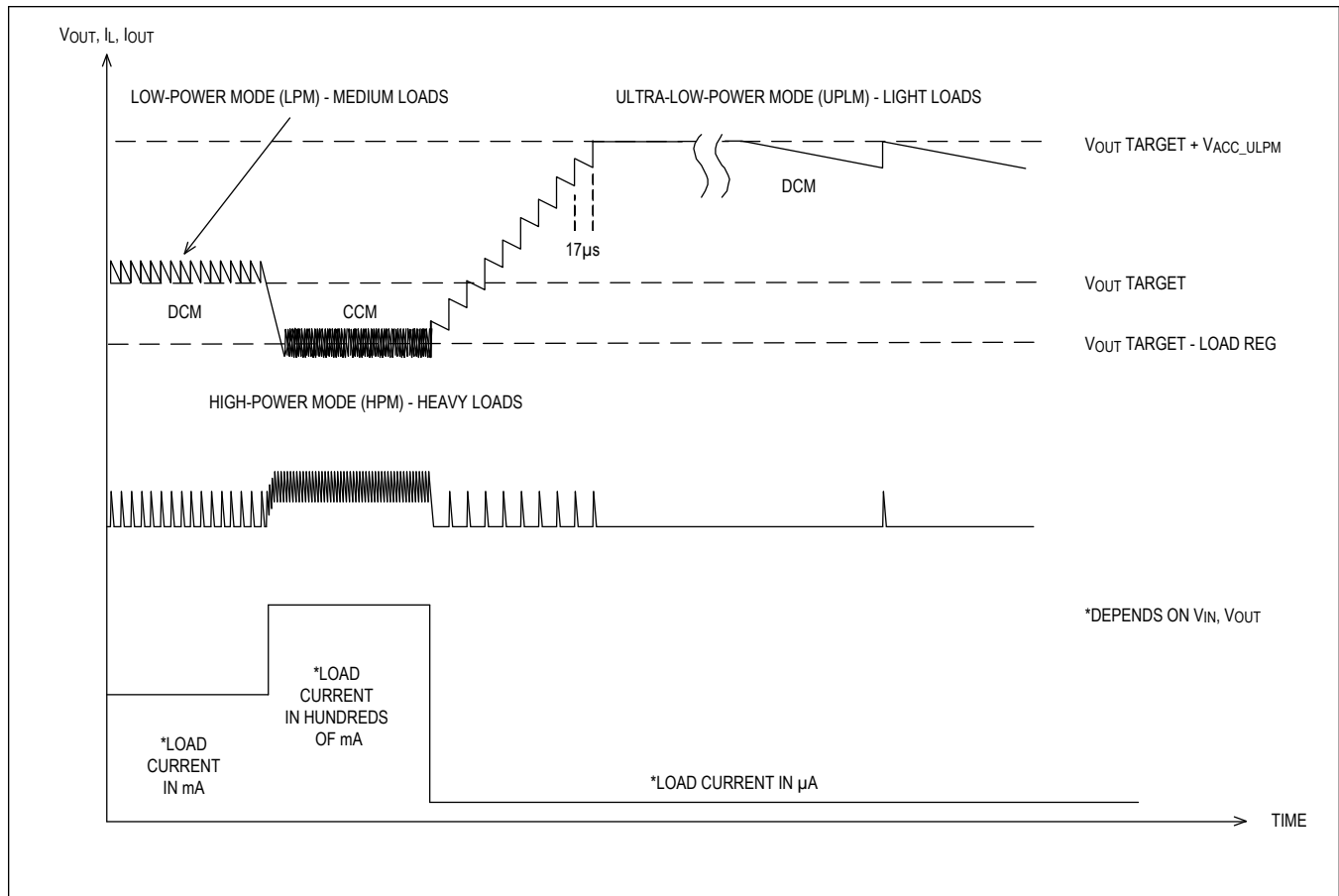

Figure 2. LPM, HPM, ULPM Transition Waveforms

Output Voltage Selection

The MAX17227A has a unique single resistor output selection method where one can select 32 different voltage selections from 2.3V to 5.5V, as shown in [Table 1](#).

At startup, the MAX17227A sources up to 200 μ A during the select resistor detection time, typically for 600 μ s (t_{RSEL}), to read the R_{SEL} value.

Care must be taken that the total capacitance on this pin should be less than 2pF. See [PCB Layout Guidelines](#) for more information.

The RSEL output voltage selection method has many benefits:

- In conventional boost converters, current is drawn from output continuously through a feedback resistor-divider. In the MAX17227A, 200 μ A current will be drawn from output only during startup, which will help to increase efficiency at light loads.
- Lower cost and smaller size, since only one resistor is needed versus the two resistors needed in typical feedback connections.
- The RSEL feature allows customers to stock just one part in their inventory system and use it in multiple projects with different output voltages just by changing a single standard 1% resistor.
- The RSEL feature allows much higher internal feedback resistors instead of lower impedance external feedback resistors to enable for ultra-low-power applications.

Select the R_{SEL} resistor value by choosing the desired output voltage in the [Table 1](#).

Table 1. R_{SEL} Selection Table

TARGET OUTPUT VOLTAGE V _{OUT} (V)	R _{SEL} STANDARD RESISTOR 1% (kΩ)
2.3	OPEN
2.4	909
2.5	768
2.6	634
2.7	536
2.8	452
2.9	383
3.0	324
3.1	267
3.2	226
3.3	191
3.4	162
3.5	133
3.6	113
3.7	95.3
3.8	80.6
3.9	66.5
4.0	56.2
4.1	47.5
4.2	40.2
4.3	34.0
4.4	28.0
4.5	23.7
4.6	20.0
4.7	16.9
4.8	14.0
4.9	11.8
5.0	10.0
5.1	8.45
5.2	7.15
5.4*	4.99
5.5*	SHORT TO GROUND

* Indicates ULPM disabled.

Fixed-Output Voltage Version

In applications where board space is at a premium, contact a Maxim Integrated representative to order fixed-output versions that don't require the R_{SEL} resistor to program the output voltage. The RSEL pin must be left floating for fixed output versions. The output voltage can be preprogrammed in the range from 2.3V to 5.2V with 100mV resolution. 5.3V, 5.4V, and 5.5V output target levels are available. The output target levels programmed to 5.3V, 5.4V, and 5.5V will have the ULPM disabled.

Features

Enable

The MAX17227A includes an enable input pin (EN). Connect EN pin to IN pin or drive it to more than 0.6V (V_{EN_IH}) for normal operation. When EN pin goes below 0.55V (V_{EN_IL}), MAX17227A enters True Shutdown mode. The device will consume 1nA (I_{SD_IN}) of current from V_{IN} while in this mode.

In shutdown, the output is truly disconnected from the input. In conventional boost circuits, the body diode of the synchronous rectifier is forward biased in shutdown and allows current flow from the battery to the output. If the load cannot be shut down, a load switch is required to avoid depleting the battery during the shutdown. A proprietary design in the MAX17227A allows the synchronous rectifier to provide True Shutdown with no additional components. True Shutdown on the MAX17227A allows the output to be biased at any voltage or grounded without consuming any current from IN or OUT pins other than pin leakage currents.

Soft-Start Control

After the EN pin goes above its raising threshold (V_{EN_IH}), the MAX17227A begins the startup.

When the output capacitor is fully discharged prior to the device enable, the startup follows following steps:

When V_{IN} is at its final level, for example 3V, the MAX17227A ramps the output to the level where V_{OUT} starts approaching V_{IN} at which point switching is enabled. It will then acquire RSEL pin voltage level to determine the output target level. Then, the output is ramped up to its target voltage level, for example 5.0V following 3V/ms slew rate. This will control amount of the inrush current into the output capacitor.

The MAX17227A is able to startup with 0.88V input voltage into load resistance of 3k Ω or larger. Enabling the device when V_{IN} is between 0.88V and 2.0V will be load current limited. If the load current is heavy such that it does not allow the MAX17227A to charge the output above 1.5V, the device cannot reach its output target level until V_{IN} is increased or the load current is reduced.

The MAX17227A will initiate a controlled soft-start in an event supply voltage is applied at high dV/dt rate; for example, during installation of a fresh battery. While in regulation, if V_{IN} steps abruptly above V_{OUT} for more than 1V, the device will reset. In this case, output voltage droop will be a function of the load current, output capacitance, and time required for soft-start to complete, which is typically 1.6ms.

For maximum load conditions during soft-start, see the [Typical Operating Characteristic](#) section.

Short-Circuit Protection

The MAX17227A is protected from an output short-circuit condition by current and thermal overload circuits. If the output voltage is detected 1V lower than the input voltage during operation, the MAX17227A enters the short-circuit protection mode. Once the short-circuit event is detected, the synchronous rectifier and its body diode are disconnected from the output, and the short-circuit protection block gets engaged. The short-circuit current (I_{IN_PT}) is limited to 1.1A. Under this condition, the part will heat up due to high power dissipation in the short-circuit protection device, and likely enter thermal shutdown.

Thermal Shutdown

The MAX17227A features thermal shutdown. The converter and short circuit protection device turn off when the junction temperature exceeds +165°C. Once the device cools by 15°C, the converter will resume operation. If the fault condition is not removed, the regulator will cycle on and off.

Design Procedure

Inductor Selection

It is recommended to use a 1.0 μ H inductor. This inductor value provides the best size and efficiency trade-off in most applications.

Input Capacitor

Input capacitors reduce current peaks from the input supply and increase efficiency. For the input capacitor, choose a ceramic capacitor because they have the lowest equivalent series resistance (ESR), smallest size, and lowest cost. Other capacitor types can be used as well but will have larger ESR. The biggest downside of ceramic capacitors is their capacitance derating with higher DC bias and, because of this, at minimum a standard 22 μ F ceramic capacitor is recommended at the input for all applications. For applications which use batteries that have a high source impedance greater than 1 Ω , more capacitance may be needed. A good starting point is to use the same capacitance value at the input as well as output. In applications where V_{IN} is approaching V_{OUT} , more input capacitance will be required to minimize input voltage ripple.

At a minimum, a standard 22 μ F X7R ceramic capacitor is recommended for all applications. Due to DC bias effects the effective capacitance can be 80% lower than the nominal capacitor value. The capacitor data sheet needs to be consulted for proper DC bias, AC ripple, and temperature capacitance derating.

Output Capacitor

A 22 μ F ceramic capacitor is recommended for all applications. The output capacitor (C_{OUT}) is required to keep the output voltage ripple small and to ensure loop stability. C_{OUT} must have low impedance at the switching frequency. Ceramic capacitors are recommended due to their small size and low ESR. Make sure the minimum effective capacitance is 11 μ F over temperature, DC bias, and AC ripple capacitor data sheet specifications. Capacitors with X7R temperature characteristics typically perform well. In applications where V_{IN} is approaching V_{OUT} , more output capacitance will be required to minimize the output voltage ripple.

PCB Layout Guidelines

Careful PCB layout is especially important in nanoPower DC-DC converters. Poor layout can affect the IC performance, causing electromagnetic interference (EMI) and electromagnetic compatibility (EMC) issues, ground bounce, and voltage drops, etc. Poor layout can also affect regulation and stability.

A good layout is implemented using the following rules:

- Place the inductor, input capacitor, and output capacitor close to the IC using short traces. These components carry high switching currents, and long traces act like antennas. The output capacitor placement is the most important in the PCB layout and should be placed directly next to the IC. The inductor and input capacitor placement are secondary to the output capacitor's placement but should remain close to the IC.
- The connection from the bottom plate of the output capacitor and the ground pin of the device must be extremely short, as should be that of the input capacitor.
- Similarly, the top plate of output capacitor and the OUT pin of the device must be short as well.
- Minimize the surface area used for LX since this is the noisiest node.
- Keep the main power path from IN, LX, OUT, and GND as tight and short as possible.
- Route the output voltage path away from the inductor and LX_ switching node to minimize noise and magnetic interference.
- Maximize the size of the ground metal on the component side to help with thermal dissipation. Use a ground plane with several vias connecting to the component-side ground to further reduce noise interference on sensitive circuit nodes.
- Lastly, the trace used for RSEL should neither be too long nor should produce a capacitance of more than 2pF.

It is recommended to consult the MAX17227A EV kit layout.

Thermal Considerations

In most applications, the IC does not dissipate much heat due to its high efficiency. But in applications where the IC runs at high ambient temperature with heavy loads, the heat dissipated may cause the temperature to exceed +125°C

or the maximum junction temperature of the part. If the junction temperature reaches approximately +165°C ($T_{J \text{ Rising}}$), the thermal-overload protection is activated. The maximum power dissipation depends on the thermal resistance of the IC package and the application circuit board.

The power dissipated (P_D) in the device is:

$$P_D = P_{IN} - P_{OUT} - P_{IND}$$

where P_{IND} is power dissipated in the inductor that includes DC, AC, and core losses; P_{OUT} is power delivered to the load.

The maximum allowed power dissipation is:

$$P_{D_MAX} = (T_{JMAX} - T_A) / \theta_{JA}$$

where $(T_{JMAX} - T_A)$ is the temperature difference between the MAX17227A maximum rated junction temperature (+125°C) and the surrounding ambient temperature, and θ_{JA} is the thermal resistance of the junction through the package, PCB, copper traces, and other materials to the surrounding ambient temperature.

MAX17227A

400mV to 5.5V Input, 2A nanoPower Boost Converter with Short-Circuit Protection and True Shutdown

Ordering Information

PART NUMBER	TEMPERATURE RANGE	PIN-PACKAGE
MAX17227AANT+	-40°C to +125°C	6-bump WLP
MAX17227AATA+	-40°C to +125°C	8-pin TDFN

+Denotes a lead(Pb)-free/RoHS-compliant package.

T = Tape and reel.

MAX17227A

400mV to 5.5V Input, 2A nanoPower Boost
Converter with Short-Circuit Protection and True
Shutdown

Revision History

REVISION NUMBER	REVISION DATE	DESCRIPTION	PAGES CHANGED
0	1/20	Initial release	—
1	12/20	Added <i>Typical Operating Characteristics</i> ; updated <i>Absolute Maximum Ratings</i> , <i>Pin Description</i> table, <i>Functional Diagram</i> , <i>Ordering Information</i> table	6, 9–12, 14, 15, 23
2	7/21	Updated <i>Benefits and Features</i> , <i>Absolute Maximum Ratings</i> , and <i>Detailed Description</i> section	1, 6, 18

For pricing, delivery, and ordering information, please visit Maxim Integrated's online storefront at <https://www.maximintegrated.com/en/storefront/storefront.html>.

Maxim Integrated cannot assume responsibility for use of any circuitry other than circuitry entirely embodied in a Maxim Integrated product. No circuit patent licenses are implied. Maxim Integrated reserves the right to change the circuitry and specifications without notice at any time. The parametric values (min and max limits) shown in the Electrical Characteristics table are guaranteed. Other parametric values quoted in this data sheet are provided for guidance.