

Typical Applications

The HMC631LP3(E) is ideal for:

- Cellular/3G & WiMAX Systems
- Wireless Infrastructure HPA & MPCA Error Correction
- Pre-Distortion or Feed-Forward Linearization
- Beam Forming & Nulling Circuits

Features

- Continuous Phase Control: 360°
- Continuous Gain Control: 40 dB
- Output Noise Floor: -160 dBm/Hz
- Input IP3: +35 dBm
- 16 Lead 3x3mm SMT Package: 9mm²

Functional Diagram

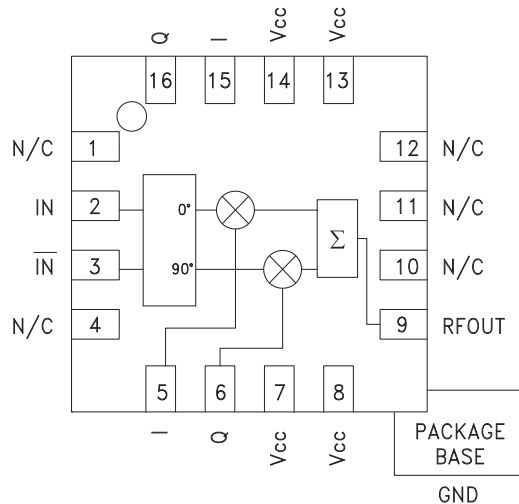

General Description

The HMC631LP3 & HMC631LP3E are high dynamic range Vector Modulator RFICs which are targeted for RF predistortion and feed-forward cancellation circuits, as well as RF cancellation, beam forming and amplitude/phase correction circuits. The I & Q ports of the HMC631LP3(E) can be used to continuously vary the phase and amplitude of RF signals by up to 360 degrees and 40 dB respectively, while supporting a 3 dB modulation bandwidth of 200 MHz. With an output IP3 of +26 dBm and output noise floor of -160 dBm/Hz (at maximum gain setting), the IP3/noise floor ratio is 186 dB.

10

MODULATORS - SMT

Electrical Specifications, $T_A = +25^\circ \text{C}$, $V_{CC} = +8\text{V}$

Parameter	Min.	Typ.	Max.	Min.	Typ.	Max.	Units
Frequency Range		1.8 - 2.2		2.2 - 2.7			GHz
Maximum Gain ⁽¹⁾	-11	-9			-11		dB
Gain Variation Over Temperature		0.016	0.025		0.016		dB / °C
Gain Flatness Across Any 60 MHz Bandwidth		0.15			0.4		dB
Gain Range		40			40		dB
Input Return Loss		9			9		dB
Output Return Loss		13			10		dB
Input Power for 1dB Compression (P1dB)	15	18			21		dBm
Input Third Order Intercept (IP3)		35			37		dBm
Output Noise		-160			-160		dBm/Hz
Control Port Bandwidth (-3 dB)		200			200		MHz
Control Port Impedance		1.45k			1.45k		Ohms
Control Port Capacitance		0.22			0.22		pF
Control Voltage Range		+0.5 to +2.5			+0.5 to +2.5		Vdc
Group Delay Variation Over 60 MHz Bandwidth		20			20		ps
Supply Current (I _{cc})		93			93		mA

Unless otherwise noted, measurements are made @ max. gain setting and 45° phase setting. See application circuit for details.

⁽¹⁾Includes loss of input balun (0.8 dB typ.)

Maximum Gain vs. Temperature

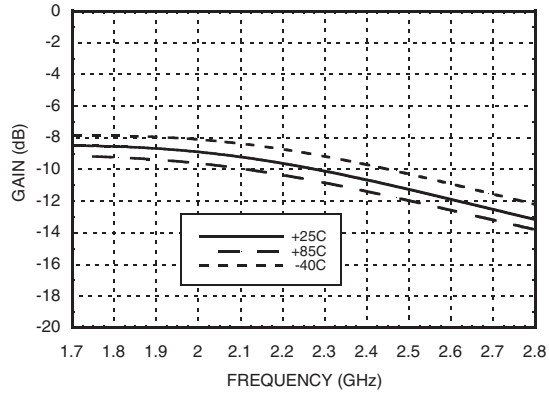

Maximum Gain vs. Supply Voltage

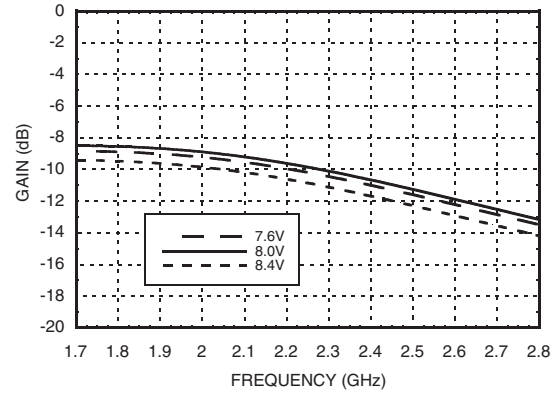

Gain vs. Phase Settings @ F= 2 GHz

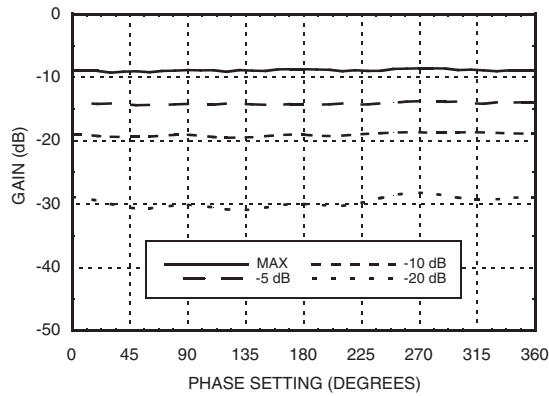

Phase vs. Phase Settings @ F= 2 GHz vs. Various Gain Settings

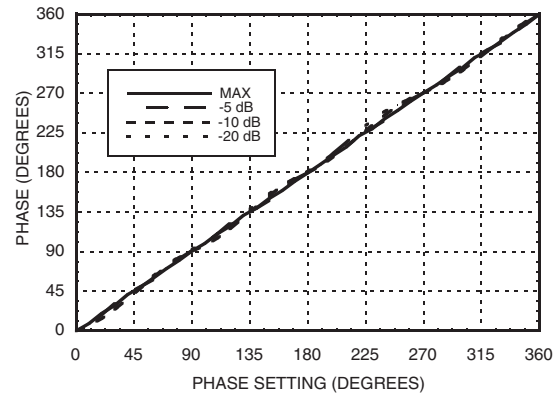

Input Return Loss vs. Temperature

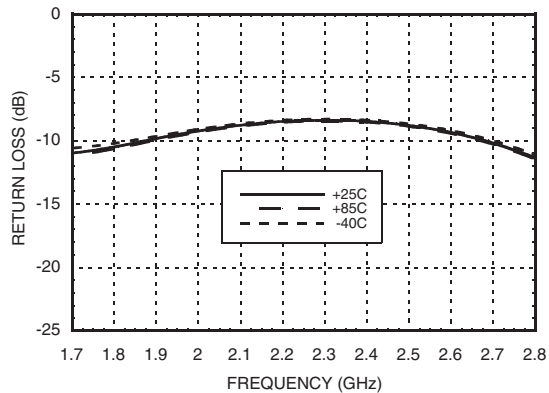

Output Return Loss vs. Temperature

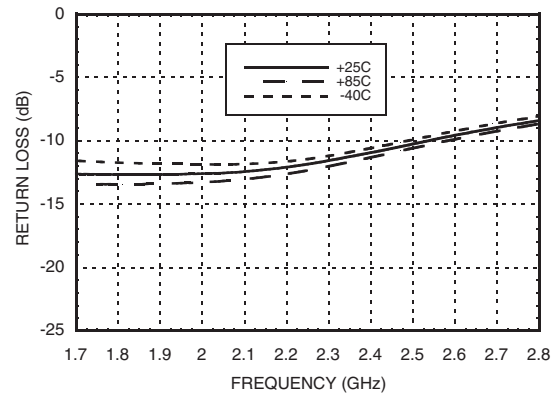



HMC631LP3 / 631LP3E

GaAs HBT VECTOR MODULATOR 1.8 - 2.7 MHz

Output Noise vs. Temperature

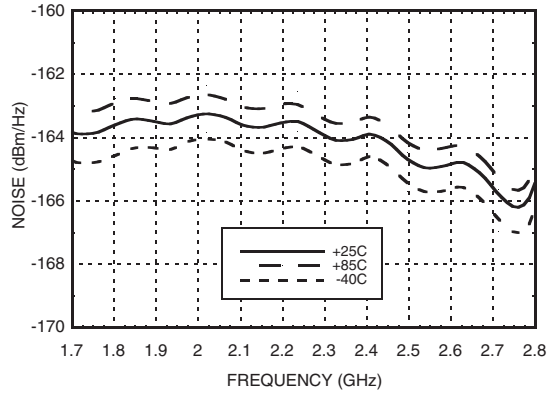

Output Noise vs. Phase Settings @ F= 2 GHz

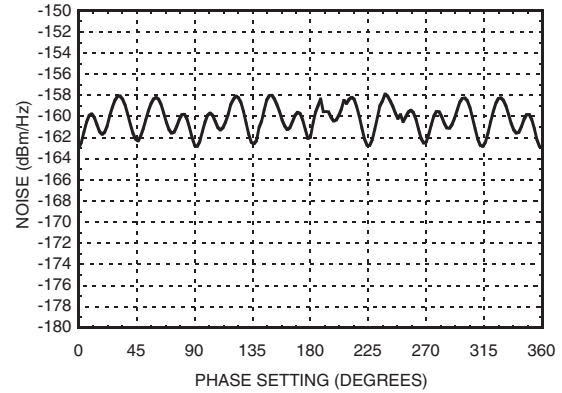

Input P1dB vs. Temperature

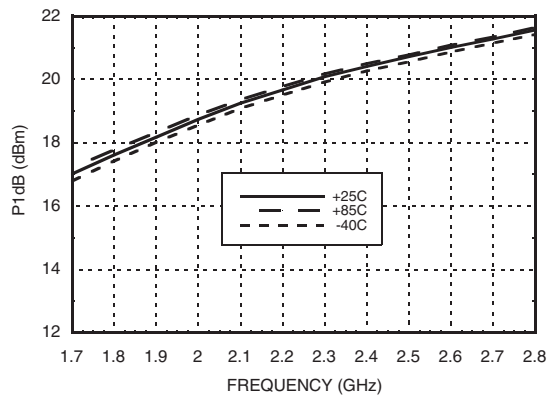

Input IP3 vs. Temperature

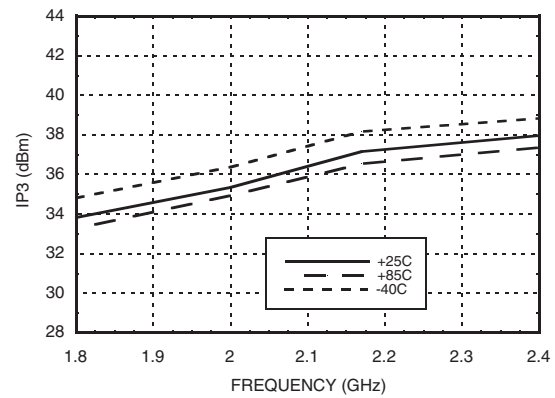

Group Delay

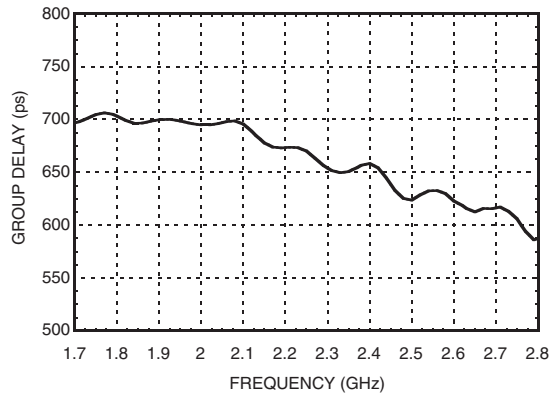

Linear Gain vs. Phase Setting

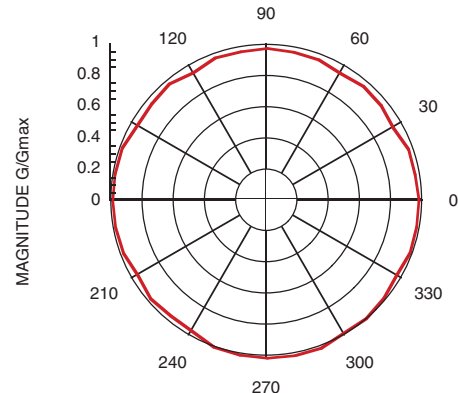

10

MODULATORS - SMT



Typical Supply Current vs. Vcc

Vcc (V)	Icc (mA)
7.6	88
8.0	93
8.4	99

Note:
Modulator will operate over full voltage range shown above.



**ELECTROSTATIC SENSITIVE DEVICE
OBSERVE HANDLING PRECAUTIONS**

Absolute Maximum Ratings

RF Input (Vcc = +8V)	27 dBm
Supply Voltage (Vcc)	+10V
I & Q Input	-0.5V to +5V
Junction Temperature (Tc)	135 °C
Continuous P _{diss} (T = 85°C) (Derate 34 mW/°C above 85°C)	1.7 W
Thermal Resistance (R _{th}) (junction to ground paddle)	29.6 °C/W
Storage Temperature	-65 to +150 °C
Operating Temperature	-40 to +85 °C

Outline Drawing

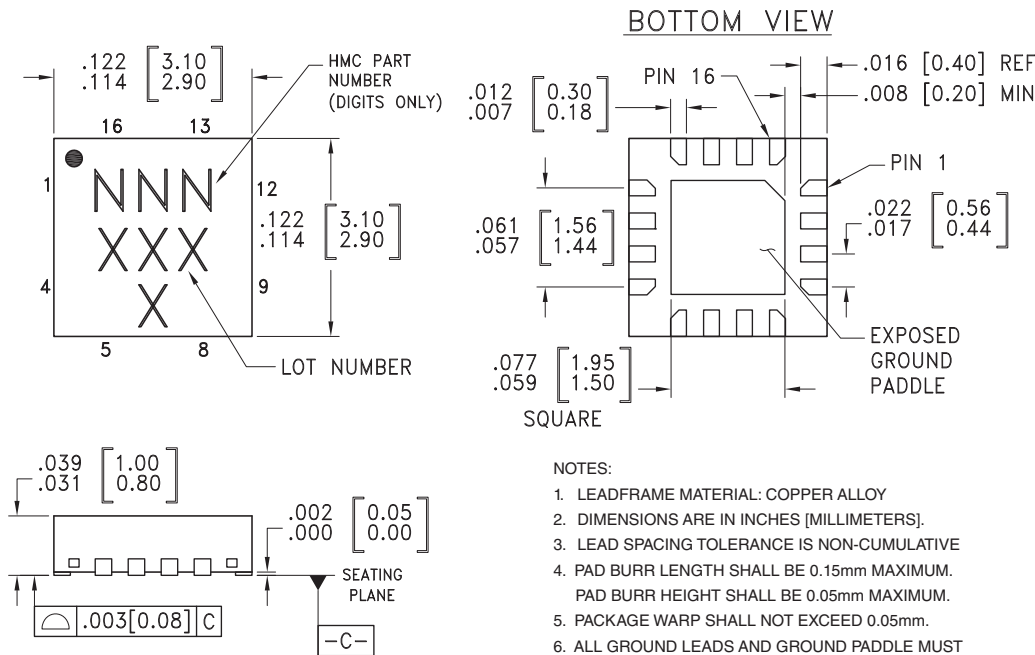

NOTES:

- LEADFRAME MATERIAL: COPPER ALLOY
- DIMENSIONS ARE IN INCHES [MILLIMETERS].
- LEAD SPACING TOLERANCE IS NON-CUMULATIVE
- PAD BURR LENGTH SHALL BE 0.15mm MAXIMUM.
PAD BURR HEIGHT SHALL BE 0.05mm MAXIMUM.
- PACKAGE WARP SHALL NOT EXCEED 0.05mm.
- ALL GROUND LEADS AND GROUND PADDLE MUST BE SOLDERED TO PCB RF GROUND.
- REFER TO HITTITE APPLICATION NOTE FOR SUGGESTED PCB LAND PATTERN.

Package Information

Part Number	Package Body Material	Lead Finish	MSL Rating	Package Marking ^[3]
HMC631LP3	Low Stress Injection Molded Plastic	Sn/Pb Solder	MSL1 ^[1]	631 XXXX
HMC631LP3E	RoHS-compliant Low Stress Injection Molded Plastic	100% matte Sn	MSL1 ^[2]	631 XXXX

[1] Max peak reflow temperature of 235 °C



[2] Max peak reflow temperature of 260 °C

[3] 4-Digit lot number XXXX

For price, delivery, and to place orders, please contact Hittite Microwave Corporation:
20 Alpha Road, Chelmsford, MA 01824 Phone: 978-250-3343 Fax: 978-250-3373
Order On-line at www.hittite.com

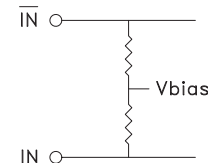
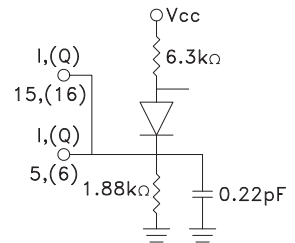
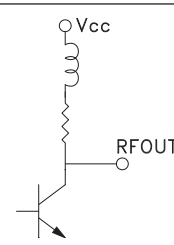

Pin Description

Pin Number	Function	Description	Interface Schematic
1, 4, 10 - 12	N/C	No connection. These pins may be connected to RF ground. Performance will not be affected	
2, 3	IN, \bar{IN}	Differential RF inputs, 100 Ohms differential impedance. (i.e. each pin is 50 Ohms to ground). Must be DC blocked.	
5, 15	I	In-phase control input. Pins 5 and 15 are redundant. Either input can be used.	
6, 16	Q	Quadrature control input. Pins 6 and 16 are redundant. Either input can be used.	
7, 8, 13, 14	Vcc	Supply Voltage, pins are DC connected on-chip. It is only necessary to supply Vcc to any 1 of the 4 pins, but all 4 pins must be bypassed to ground. (See application circuit).	
9	RFOUT	RF Output: Must be DC blocked.	
	GND	Ground: Backside of package has exposed metal ground paddle which must be connected to RF/DC ground.	

Application Circuit

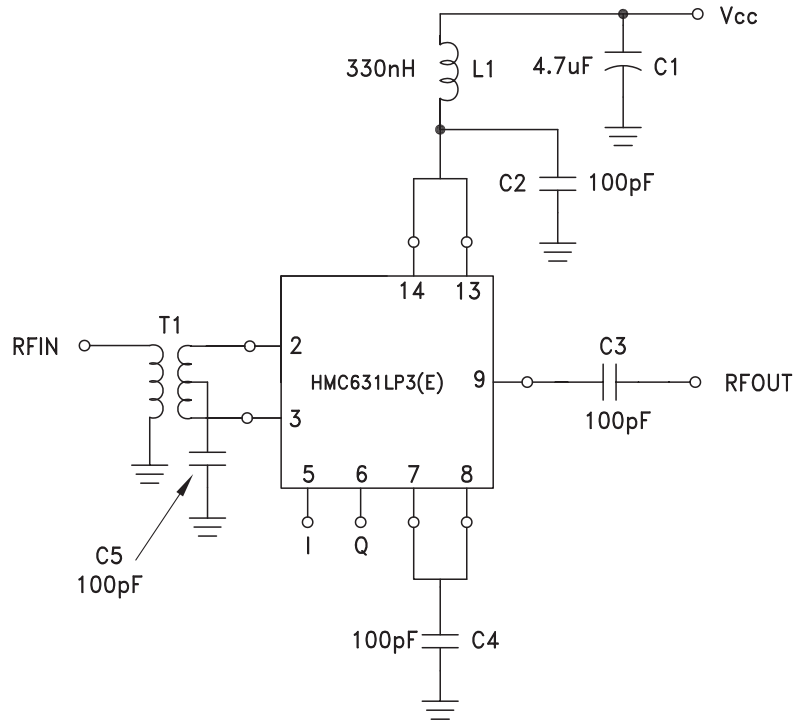

* Pins 15 & 16 are redundant I & Q inputs.

Gain and Phase control are applied through the I and Q control ports. For a given linear gain (G) and phase (θ) setting, the voltages applied to these ports in all measurements are calculated as follows:

$$I(G, \theta) = V_{mi} + 1.0V \frac{G}{G_{max}} \cos(\theta)$$

$$Q(G, \theta) = V_{mq} + 1.0V \frac{G}{G_{max}} \sin(\theta)$$

Where V_{mi} and V_{mq} are the I and Q voltage settings corresponding to maximum isolation at room temperature and $F = 2$ GHz. Note that $G = 10^x$ and $G_{max} = 10^y$ where $x = \frac{\text{Gain Setting (dB)}}{20}$ and $y = \frac{\text{Max Gain Setting (dB)}}{20}$. Nominally $V_{mi} = V_{mq} = 1.5V$, $G_{max} = 0.316$.

Evaluation PCB

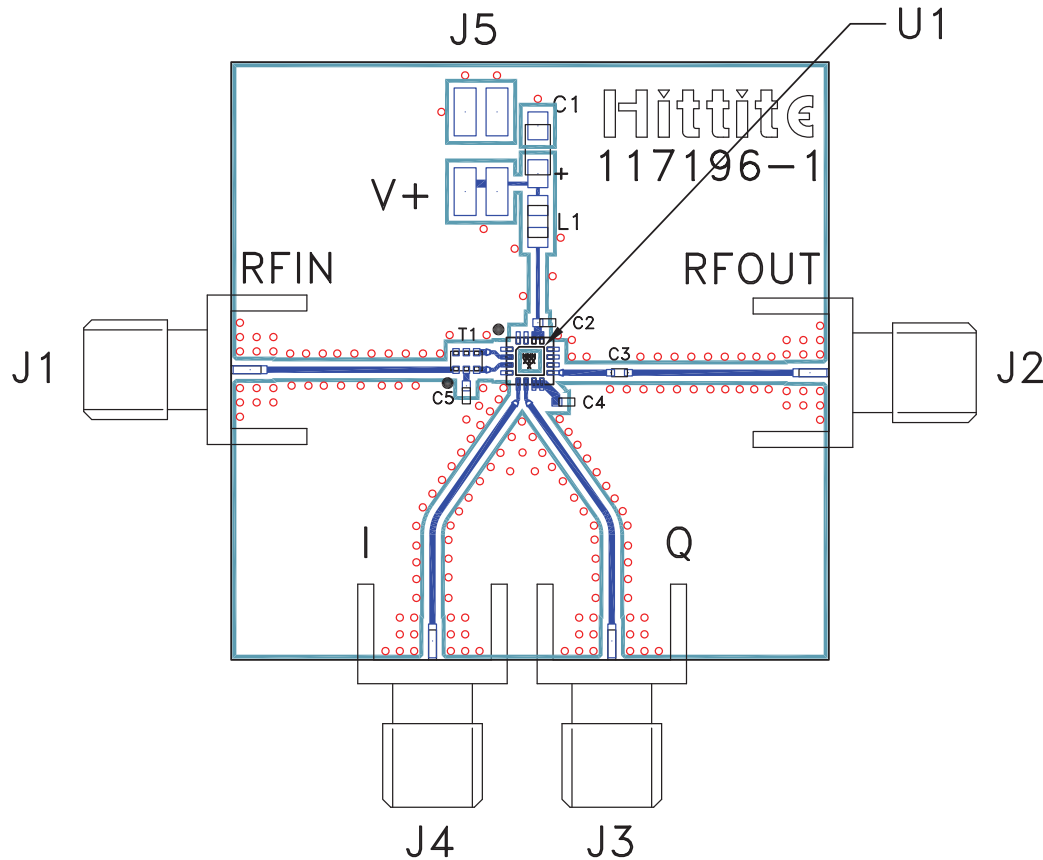

List of Materials for Evaluation PCB 117201 ^[1]

Item	Description
J1 - J4	PCB Mount SMA Connector
J5	2 mm DC Header
C1	4.7 μ F Capacitor, Tantalum
C2 - C5	100 pF Capacitor, 0402 Pkg.
T1	Balun, 0805 Pkg. ANAREN BD1722J50100A
L1	330 nH Inductor, 0805 Pkg.
U1	HMC631LP3(E) Vector Modulator
PCB ^[2]	117196 Evaluation PCB

[1] Reference this number when ordering complete evaluation PCB

[2] Circuit Board Material: Rogers 4350, Er = 3.48

The circuit board used in the final application should use RF circuit design techniques. Signal lines should have 50 ohm impedance while the package ground leads and exposed paddle should be connected directly to the ground plane similar to that shown. A sufficient number of via holes should be used to connect the top and bottom ground planes. The evaluation board should be mounted to an appropriate heat sink. The evaluation circuit board shown is available from Hittite upon request.



Notes: