

**NOTES:**

1. FINISHED CABLE ASSEMBLY TO BE COILED
2. OVERMOLD BOOT MATERIAL: PVC, BLACK
3. ELECTRICAL TEST: 100% CONTINUITY

ASS'Y P/N	NO. OF POS.	"X" DIM.
CARA62802S07990	2	6 FT. 7 IN. ±2 IN. [2M]
CARA62803S07990	3	
CARA62804S07990	4	
CARA62805S07990	5	
CARA62806S07990	6	
CARA62807S07990	7	
CARA62808S07990	8	
CARA6280XSXXX90		

CABLE LENGTH IN "INCHES"

NO OF POSITIONS

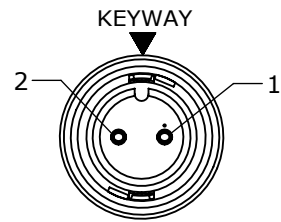

**FACE VIEW**  
P/N: CARA62802SXXX90

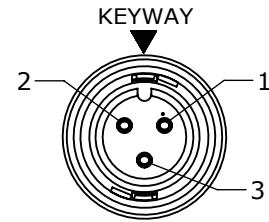

**FACE VIEW**  
P/N: CARA62803SXXX90

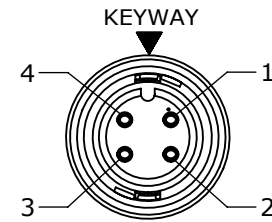

**FACE VIEW**  
P/N: CARA62804SXXX90

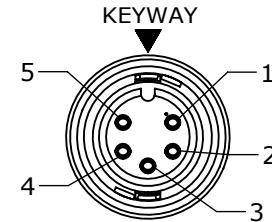

**FACE VIEW**  
P/N: CARA62805SXXX90

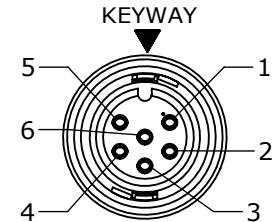

**FACE VIEW**  
P/N: CARA62806SXXX90

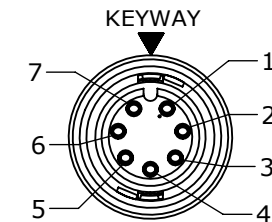

**FACE VIEW**  
P/N: CARA62807SXXX90

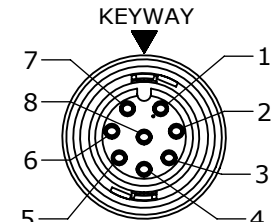

**FACE VIEW**  
P/N: CARA62808SXXX90

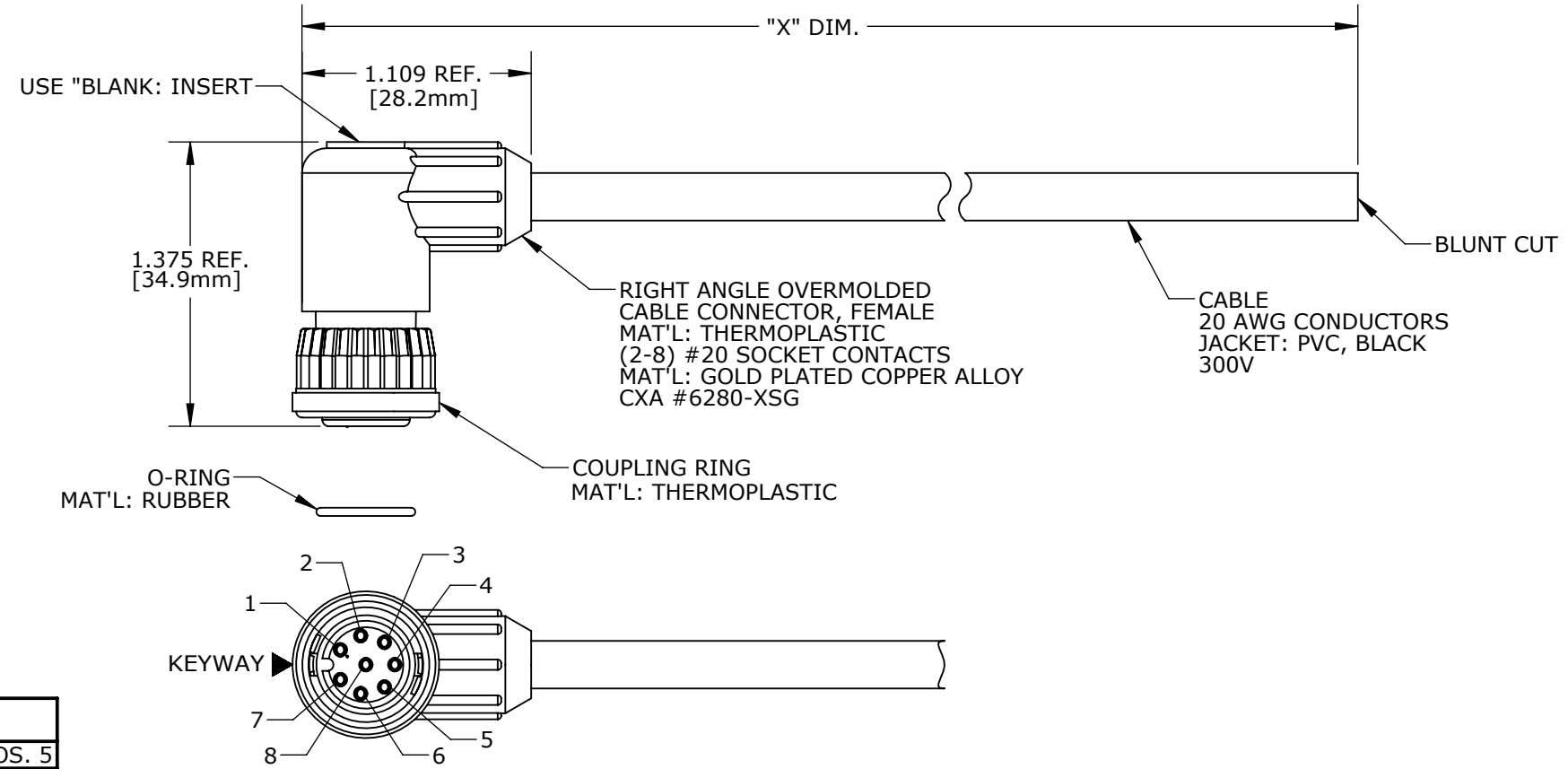

**END "A"**  
FACE VIEW  
P/N: CARA62808SXXX90

**CUSTOMER APPROVAL**

THIS DOCUMENT CONTAINS CONFIDENTIAL INFORMATION PROPRIETARY TO CONXALL CORPORATION. ANY REPRODUCTION, DISCLOSURE, OR USE OF THIS DOCUMENT /INFORMATION IS EXPRESSLY PROHIBITED UNLESS AUTHORIZED IN WRITING BY CONXALL CORPORATION.

APPROVED BY: \_\_\_\_\_

DATE: \_\_\_\_\_

ASSY P/N	CABLE	COLOR CODE END "A"
CARA62802SXXX90	2/20 AWG O.D. 0.215 REF	COLOR CODE
		POS. 1 POS. 2 BLK WHT
CARA62803SXXX90	3/20 AWG O.D. 0.220 REF	WIRE COLOR CODE
		POS. 1 POS. 2 POS. 3 BLK WHT GRN
CARA62804SXXX90	4/20 AWG O.D. 0.235 REF	WIRE COLOR CODE
		POS. 1 POS. 2 POS. 3 POS. 4 BLK WHT GRN RED
CARA62805SXXX90	5/20 AWG O.D. 0.255 REF	WIRE COLOR CODE
		POS. 1 POS. 2 POS. 3 POS. 4 POS. 5 BLK WHT GRN RED BLU
CARA62806SXXX90	6/20 AWG O.D. 0.275 REF	WIRE COLOR CODE
		POS. 1 POS. 2 POS. 3 POS. 4 POS. 5 POS. 6 BLK WHT GRN RED BLU VIO
CARA62807SXXX90	8/20 AWG O.D. 0.300 REF	WIRE COLOR CODE
		POS. 1 POS. 2 POS. 3 POS. 4 POS. 5 POS. 6 POS. 7 BLK WHT GRN RED BLU VIO GRY
CARA62808SXXX90	8/20 AWG O.D. 0.300 REF	WIRE COLOR CODE
		POS. 1 POS. 2 POS. 3 POS. 4 POS. 5 POS. 6 POS. 7 POS. 8 BLK WHT GRN RED BLU VIO GRY BRN

DIMENSIONS IN BRACKET [ ] ARE METRIC.

**RoHS COMPLIANT**

A	AN	06-30-16	DRAWING CREATED PER DOR 16-7414JP
REV.	INIT.	DATE	DESCRIPTION
	AN	05-26-16	ALL INFORMATION ILLUSTRATED IS THE PROPERTY OF "CONXALL CORPORATION". UNAUTHORIZED DUPLICATION OR DISTRIBUTION OF THIS DOCUMENT IS PROHIBITED.
APPROVED BY:			<p>601 E. WILDWOOD VILLA PARK, IL 60181</p>
DATE:			
TITLE:			CABLE ASSEMBLY (2-8) #20 SOCKET CONTACTS MINI-CON-X, R. ANGLE STANDARD PRODUCT
CUSTOMER:			CARA6280XSXXX90
PART NUMBER:			CARA6280XSXXX90
REV:			A

CUSTOMER PRINT

PART NUMBER: CARA6280XSXXX90