

| REVISIONS | | | | | |
|-----------|-----|---------------------|---------|-------|-------|
| REV | ECO | DESCRIPTION | DATE | BY | APPR |
| A1 | - | RELEASE NEW DRAWING | 19JUN18 | JONY | TOMMY |
| A2 | - | REVISED DRAWING | 10JUL20 | JHEAD | DH |

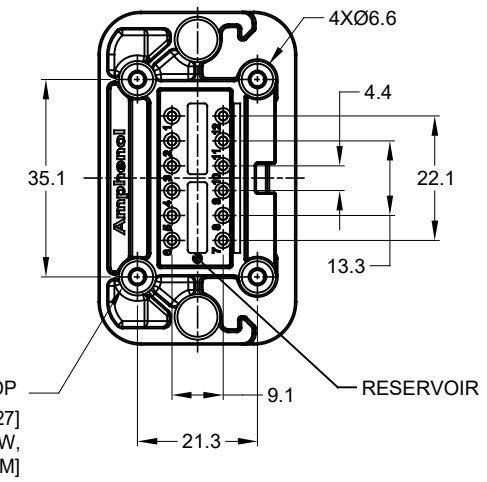

NOTES: UNLESS OTHERWISE SPECIFIED

- MATERIAL:
HOUSING: THERMOPLASTIC
SEAL: SILICONE RUBBER
CONTACT: COPPER ALLOY
- MODIFICATIONS: FLANGE, PCB MOUNT STRAIGHT
- SPECIFICATIONS:
3.1 CURRENT RATING: 13 AMPS
3.2 OPERATING TEMPERATURE: -55°C TO +125°C
3.3 DIELECTRIC WITHSTANDING VOLTAGE: LESS THAN 2 MILLIAMPS CURRENT LEAKAGE @ 1500 VOLTS AC.
3.4 INSULATION RESISTANCE: 1000 MEGOHMS MIN @ 25°C.
3.5 MOISTURE RESISTANCE: IP67 (MATED CONDITION)
3.6 MATING CYCLE DURABILITY: 100 CYCLES
3.7 RoHS COMPLIANT
- MATING PART: AT06-12S* PLUG (* = MODIFICATIONS)
- ALL DIMENSIONS ARE FOR REFERENCE USE ONLY.
- POTTED CONNECTORS SPECIFIED FOR UP TO 5 P.S.I. APPLICATIONS.

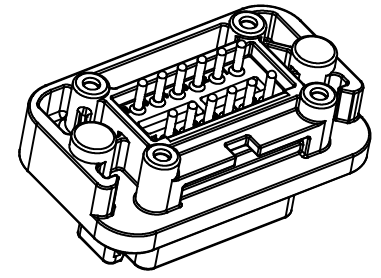
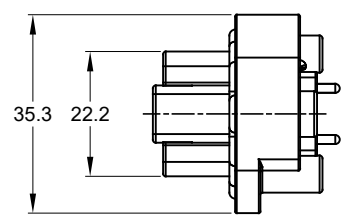

| AT15-12PX-BMXX | | DESCRIPTION | | ITEM |
|---------------------------------------|----------------|--|----------|--------------|
| QUANTITY | MATERIALS LIST | | | |
| UNLESS OTHERWISE SPECIFIED | | SIGNATURES | DATE | |
| 1) All dimensions are in metric (mm). | | DRAWN: JONY XIE | 19JUN18 | |
| 2) Tolerances are as follows: | | CHECKED: ORION LI | 19JUN18 | |
| 1 PL DEC ±0.30 | | ENGINEER: | | |
| 2 PL DEC ±0.15 | | APPROVAL: TOMMY XIE | 19JUN18 | |
| 3 PL DEC ±0.08 | | CUSTOMER: | | |
| 3) Note reference = Δ | | THIS DRAWING IS SUPPLIED FOR INFORMATION ONLY. DESIGN FEATURES, SPECIFICATIONS AND PERFORMANCE DATA SHOWN HEREON ARE THE PROPERTY OF THE AMPHENOL CORPORATION. NO RIGHTS OF REPRODUCTION ARE IMPLIED. ALL DIMENSIONS ARE SUBJECT TO NORMAL MANUFACTURING VARIATIONS. | | |
| MATERIAL SPECIFICATIONS: | | Sine Systems - www.amphenol-sine.com 44724 Morley Drive Clinton Township, MI 48036 | | |
| PROCESS SPECIFICATIONS: | | BOARDLOCK PCB MOUNT RECEPTACLE, 12 PIN, STRAIGHT, AT SERIES | | |
| NEXT ASSY: | | SIZE: B | TYPE: C- | REVISION: A2 |
| | | DWG NO: AT15-12PX-BMXX | | |
| | | SCALE: NONE | | SHEET 1 OF 3 |

TITLE: PCB MOUNT RECEPTACLE 12PIN STRAIGHT AT SERIES
DWG NO: AT15-12PX-BMXX
REV: A2
SH: 1
OF: 3

| REVISIONS | | | | | |
|-----------|-----|---------------------|---------|-------|-------|
| REV | ECO | DESCRIPTION | DATE | BY | APPR |
| A1 | -- | RELEASE NEW DRAWING | 19JUN18 | JONY | TOMMY |
| A2 | -- | REVISED DRAWING | 10JUL20 | JHEAD | DH |

P/N AT15-12PA-BMXX
KEY-A CONFIGURATION
STANDARD COLOR: GREY

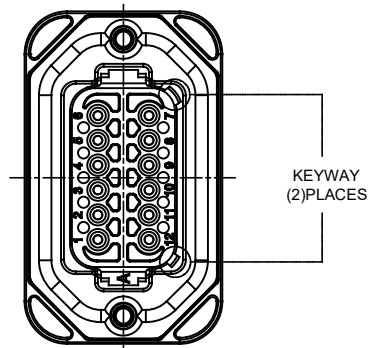

P/N AT15-12PB-BMXX
KEY-B CONFIGURATION
STANDARD COLOR: BLACK

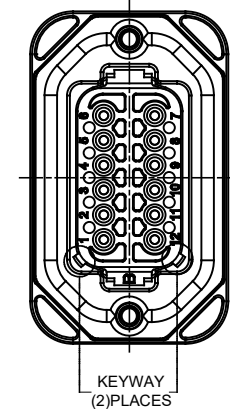

| AT15-12PA-BMXX VARIANTS | | |
|-------------------------|-----------------------------|----------------|
| CONTACT PLATING | POTTING OR NOT IN RESERVOIR | PART NUMBER |
| GOLD | NO POTTING | AT15-12PA-BM01 |
| GOLD | POTTING | AT15-12PA-BM02 |
| TIN | NO POTTING | AT15-12PA-BM03 |
| TIN | POTTING | AT15-12PA-BM04 |

| AT15-12PB-BMXX VARIANTS | | |
|-------------------------|-----------------------------|----------------|
| CONTACT PLATING | POTTING OR NOT IN RESERVOIR | PART NUMBER |
| GOLD | NO POTTING | AT15-12PB-BM01 |
| GOLD | POTTING | AT15-12PB-BM02 |
| TIN | NO POTTING | AT15-12PB-BM03 |
| TIN | POTTING | AT15-12PB-BM04 |

| AT15-12PX-BMXX | | DESCRIPTION | | ITEM |
|---|-------------|--|--|--|
| QUANTITY | PART NUMBER | | | |
| MATERIALS LIST | | | | |
| <small>UNLESS OTHERWISE SPECIFIED</small> 1) All dimensions are in metric(mm). 2) Tolerances are as follows: 1 PL DEC ±0.30 2 PL DEC ±0.15 3 PL DEC ±0.08 3) Note reference = Δ | | <small>SIGNATURES</small> DRAWN: JONY XIE 19JUN18 CHECKED: ORION LI 19JUN18 ENGINEER: APPROVAL: TOMMY XIE 19JUN18 CUSTOMER: | | DATE 19JUN18 19JUN18 19JUN18 |
| <small>MATERIAL SPECIFICATIONS:</small> THIS DRAWING IS SUPPLIED FOR INFORMATION ONLY. DESIGN FEATURES, SPECIFICATIONS AND PERFORMANCE DATA SHOWN HEREON ARE THE PROPERTY OF THE AMPHENOL CORPORATION. NO RIGHTS OF REPRODUCTION ARE IMPLIED. ALL DIMENSIONS ARE SUBJECT TO NORMAL MANUFACTURING VARIATIONS. | | Amphenol Sine Systems - www.amphenol-sine.com 44724 Morley Drive Clinton Township, MI 48036 | | BOARDLOCK PCB MOUNT RECEPTACLE, 12 PIN, STRAIGHT, AT SERIES |
| <small>PROCESS SPECIFICATIONS:</small> NEXT ASSY: | | SIZE: B C- TYPE: C- SCALE: NONE | | DWG NO: AT15-12PX-BMXX REVISION: A2 SHEET 2 OF 3 |

TITLE: PCB MOUNT RECEPTACLE, 12PIN, STRAIGHT, AT SERIES
DWG NO: AT15-12PX-BMXX
REV: A2
SH: 2
OF: 3

| REVISIONS | | | | | |
|-----------|-----|---------------------|---------|-------|-------|
| REV | ECO | DESCRIPTION | DATE | BY | APPR |
| 01 | -- | RELEASE NEW DRAWING | 19JUN18 | JONY | TOMMY |
| A2 | -- | REVISED DRAWING | 10JUL20 | JHEAD | DH |

P/N AT15-12PC-BMXX
KEY-C CONFIGURATION
STANDARD COLOR: GREEN

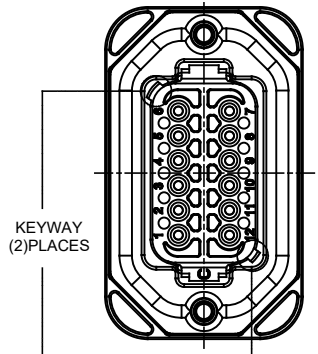

KEYWAY
(2)PLACES

P/N AT15-12PD-BMXX
KEY-D CONFIGURATION
STANDARD COLOR: BROWN

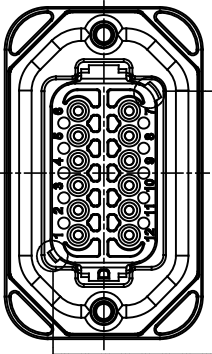

KEYWAY
(2)PLACES

| AT15-12PC-BMXX VARIANTS | | |
|-------------------------|-----------------------------|----------------|
| CONTACT PLATING | POTTING OR NOT IN RESERVOIR | PART NUMBER |
| GOLD | NO POTTING | AT15-12PC-BM01 |
| GOLD | POTTING | AT15-12PC-BM02 |
| TIN | NO POTTING | AT15-12PC-BM03 |
| TIN | POTTING | AT15-12PC-BM04 |

| AT15-12PD-BMXX VARIANTS | | |
|-------------------------|-----------------------------|----------------|
| CONTACT PLATING | POTTING OR NOT IN RESERVOIR | PART NUMBER |
| GOLD | NO POTTING | AT15-12PD-BM01 |
| GOLD | POTTING | AT15-12PD-BM02 |
| TIN | NO POTTING | AT15-12PD-BM03 |
| TIN | POTTING | AT15-12PD-BM04 |

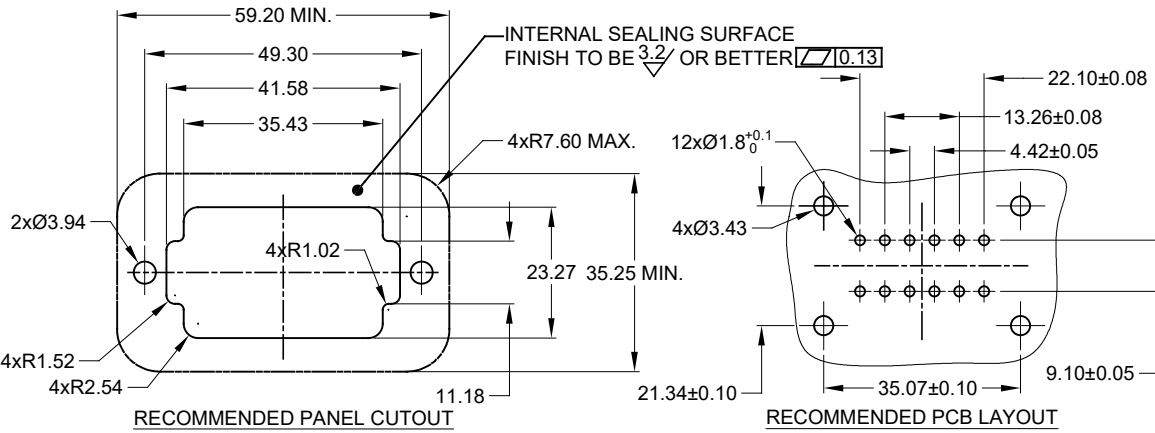

| AT15-12PX-BMXX | | DESCRIPTION | |
|--|--|--|--|
| QUANTITY | PART NUMBER | ITEM | |
| MATERIALS LIST | | | |
| <small>UNLESS OTHERWISE SPECIFIED</small> 1) All dimensions are in metric(mm). 2) Tolerances are as follows: 1 PL DEC ±0.30 Fractions ±1/64 2 PL DEC ±0.15 Angles ±1° 3 PL DEC ±0.08 3) Note reference = | | SIGNATURES DATE DRAWN: JONY XIE 19JUN18 CHECKED: ORION LI 19JUN18 ENGINEER: APPROVAL: TOMMY XIE 19JUN18 CUSTOMER: | |
| MATERIAL SPECIFICATIONS: | | Amphenol Sine Systems - www.amphenol-sine.com 44724 Morley Drive Clinton Township, MI 48036 | |
| PROCESS SPECIFICATIONS: | | BOARDLOCK PCB MOUNT RECEPTACLE, 12 PIN, STRAIGHT, AT SERIES | |
| NEXT ASSY: | THIS DRAWING IS SUPPLIED FOR INFORMATION ONLY. DESIGN FEATURES, SPECIFICATIONS AND PERFORMANCE DATA SHOWN HEREON ARE THE PROPERTY OF THE AMPHENOL CORPORATION. NO RIGHTS OF REPRODUCTION ARE IMPLIED. ALL DIMENSIONS ARE SUBJECT TO NORMAL MANUFACTURING VARIATIONS. | SIZE: C- TYPE: C- SCALE: NONE | DWG NO: AT15-12PX-BMXX REVISION: A2 |
| | | SHEET 3 OF 3 | |

TITLE: PCB MOUNT RECEPTACLE, P/N STRAIGHT, AT SERIES DWG NO: AT15-12PX-BMXX REV: A2 SH: 3 OF: 3