

## Ultra Fast NPT - IGBT®

The Ultra Fast NPT - IGBT® is a new generation of high voltage power IGBTs. Using Non-Punch-Through Technology, the Ultra Fast NPT-IGBT® offers superior ruggedness and ultrafast switching speed.

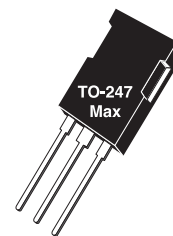

### Features

- Low Saturation Voltage
- Low Tail Current
- RoHS Compliant 
- Short Circuit Withstand Rated
- High Frequency Switching
- Ultra Low Leakage Current

Combi (IGBT and Diode)



Unless stated otherwise, Microsemi discrete IGBTs contain a single IGBT die. This device is recommended for applications such as induction heating (IH), motor control, general purpose inverters and uninterruptible power supplies (UPS).

### MAXIMUM RATINGS

 All Ratings:  $T_C = 25^\circ\text{C}$  unless otherwise specified.

Symbol	Parameter	Ratings	Unit
$V_{CES}$	Collector Emitter Voltage	1200	V
$V_{GE}$	Gate-Emitter Voltage	$\pm 30$	
$I_{C1}$	Continuous Collector Current @ $T_C = 25^\circ\text{C}$	88	A
$I_{C2}$	Continuous Collector Current @ $T_C = 110^\circ\text{C}$	40	
$I_{CM}$	Pulsed Collector Current <sup>①</sup>	160	
SCWT	Short Circuit Withstand Time: $V_{CE} = 600\text{V}$ , $V_{GE} = 15\text{V}$ , $T_C = 125^\circ\text{C}$	10	$\mu\text{s}$
$P_D$	Total Power Dissipation @ $T_C = 25^\circ\text{C}$	500	W
$T_J, T_{STG}$	Operating and Storage Junction Temperature Range	-55 to 150	$^\circ\text{C}$
$T_L$	Max. Lead Temp. for Soldering: 0.063" from Case for 10 Sec.	300	

### STATIC ELECTRICAL CHARACTERISTICS

Symbol	Parameter	Min	Typ	Max	Unit
$V_{(BR)CES}$	Collector-Emitter Breakdown Voltage ( $V_{GE} = 0\text{V}$ , $I_C = 1.0\text{mA}$ )	1200			Volts
$V_{GE(TH)}$	Gate Threshold Voltage ( $V_{CE} = V_{GE}$ , $I_C = 2.0\text{mA}$ , $T_J = 25^\circ\text{C}$ )	3.5	5.0	6.5	
$V_{CE(ON)}$	Collector-Emitter On Voltage ( $V_{GE} = 15\text{V}$ , $I_C = 40\text{A}$ , $T_J = 25^\circ\text{C}$ )		2.5	3.2	
	Collector-Emitter On Voltage ( $V_{GE} = 15\text{V}$ , $I_C = 40\text{A}$ , $T_J = 125^\circ\text{C}$ )		3.5		
	Collector-Emitter On Voltage ( $V_{GE} = 15\text{V}$ , $I_C = 88\text{A}$ , $T_J = 25^\circ\text{C}$ )		3.5		
$I_{CES}$	Collector Cut-off Current ( $V_{CE} = 1200\text{V}$ , $V_{GE} = 0\text{V}$ , $T_J = 25^\circ\text{C}$ ) <sup>②</sup>		20	1100	$\mu\text{A}$
	Collector Cut-off Current ( $V_{CE} = 1200\text{V}$ , $V_{GE} = 0\text{V}$ , $T_J = 125^\circ\text{C}$ ) <sup>②</sup>		200		
$I_{GES}$	Gate-Emitter Leakage Current ( $V_{GE} = \pm 20\text{V}$ )			$\pm 250$	nA

 **CAUTION: These Devices are Sensitive to Electrostatic Discharge. Proper Handling Procedures Should Be Followed.**

## DYNAMIC CHARACTERISTICS

APT40GR120B2D30

Symbol	Parameter	Test Conditions	Min	Typ	Max	Unit	
$C_{ies}$	Input Capacitance	Capacitance $V_{GE} = 0V, V_{CE} = 25V$ $f = 1MHz$		3980		pF	
$C_{oes}$	Output Capacitance			320			
$C_{res}$	Reverse Transfer Capacitance			80			
$V_{GEP}$	Gate to Emitter Plateau Voltage	Gate Charge $V_{GE} = 15V$ $V_{CE} = 600V$ $I_C = 40A$		7		V	
$Q_g^{(3)}$	Total Gate Charge			210		nC	
$Q_{ge}$	Gate-Emitter Charge			25			
$Q_{gc}$	Gate- Collector Charge			90			
$t_{d(on)}$	Turn-On Delay Time	Inductive Switching (25°C) $V_{CC} = 600V$ $V_{GE} = 15V$ $I_C = 40A$ $R_G = 4.3 \Omega^{(4)}$ $T_J = +25^\circ C$		22		ns	
$t_r$	Current Rise Time			25			
$t_{d(off)}$	Turn-Off Delay Time			163			
$t_f$	Current Fall Time			40			
$E_{on2}^{(5)}$	Turn-On Switching Energy	$R_G = 4.3 \Omega^{(4)}$ $T_J = +25^\circ C$		1375	3000	μJ	
$E_{off}^{(6)}$	Turn-Off Switching Energy			906	1650		
$t_{d(on)}$	Turn-On Delay Time	Inductive Switching (125°C) $V_{CC} = 600V$ $V_{GE} = 15V$ $I_C = 40A$ $R_G = 4.3 \Omega^{(4)}$ $T_J = +125^\circ C$		22		ns	
$t_r$	Current Rise Time			25			
$t_{d(off)}$	Turn-Off Delay Time			185			
$t_f$	Current Fall Time			47			
$E_{on2}^{(5)}$	Turn-On Switching Energy			1916	3500		μJ
$E_{off}^{(6)}$	Turn-Off Switching Energy			1186	2500		

## THERMAL AND MECHANICAL CHARACTERISTICS

Symbol	Characteristic	Min	Typ	Max	Unit
$R_{\theta JC}$	Junction to Case Thermal Resistance (IGBT)			.25	°C/W
	Junction to Case Thermal Resistance (Diode)			.80	
$R_{\theta JA}$	Junction to Ambient Thermal Resistance			40	
$W_T$	Package Weight		.22		oz
			6.2		g

1 Repetitive Rating: Pulse width and case temperature limited by maximum junction temperature.

2 Pulse test: Pulse Width < 380μs, duty cycle < 2%.

3 See Mil-Std-750 Method 3471.

4  $R_G$  is external gate resistance, not including internal gate resistance or gate driver impedance. (MIC4452)

5  $E_{on2}$  is the clamped inductive turn on energy that includes a commutating diode reverse recovery current in the IGBT turn on energy loss. A combi device is used for the clamping diode.

6  $E_{off}$  is the clamped inductive turn-off energy measured in accordance with JEDEC standard JESD24-1.

**Microsemi reserves the right to change, without notice, the specifications and information contained herein.**

# TYPICAL PERFORMANCE CURVES

APT40GR120B2D30

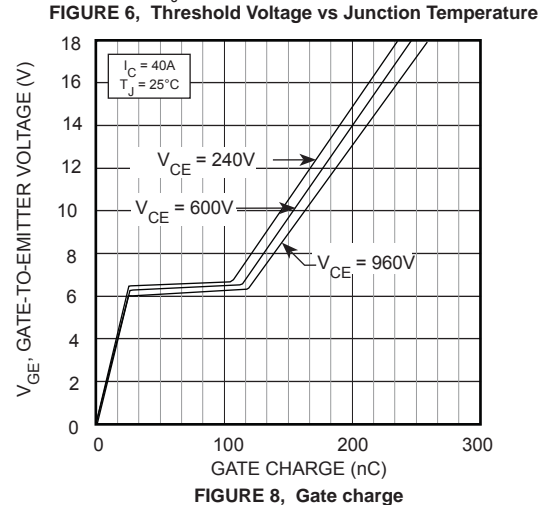
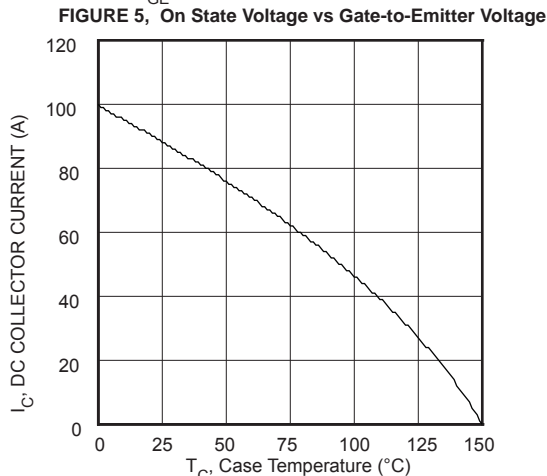
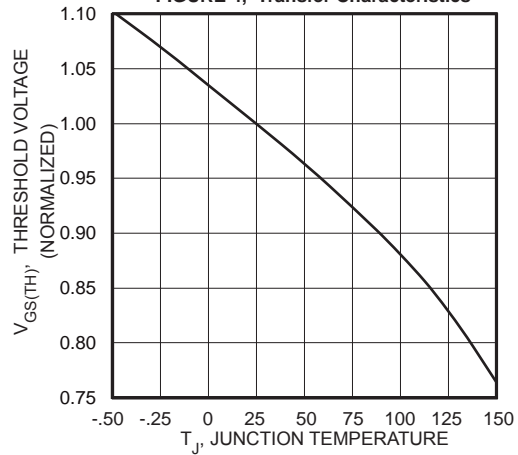
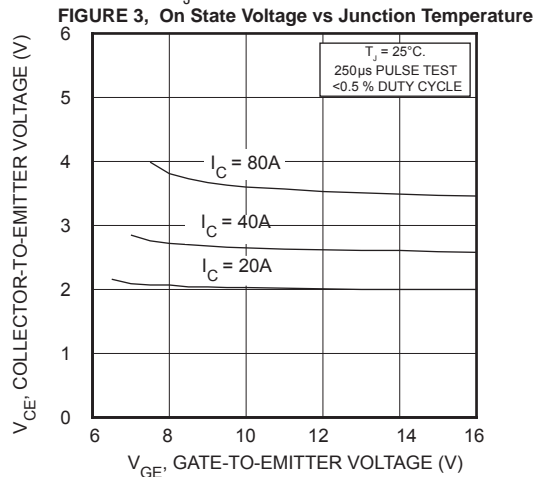
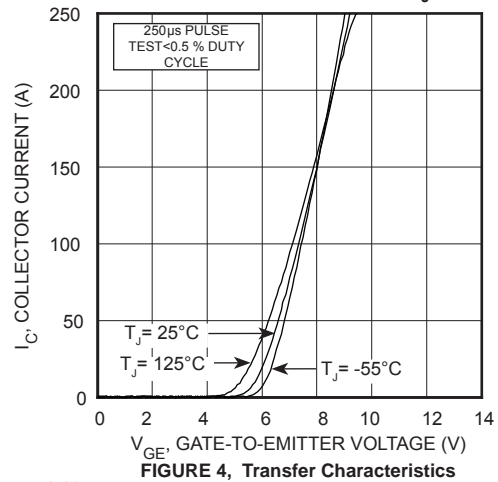
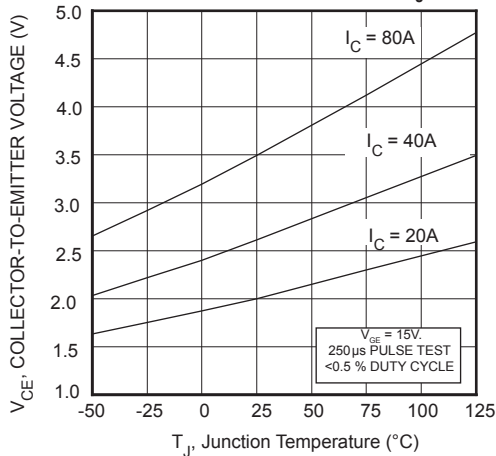
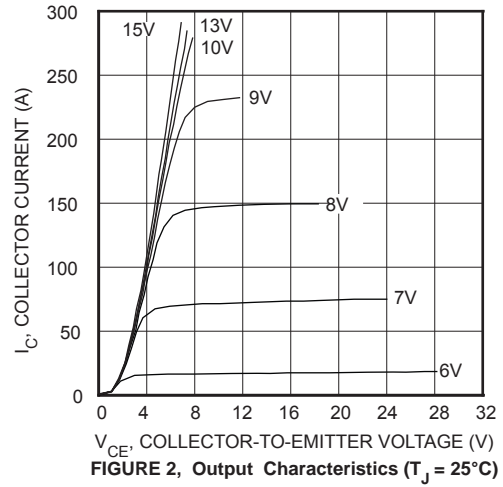
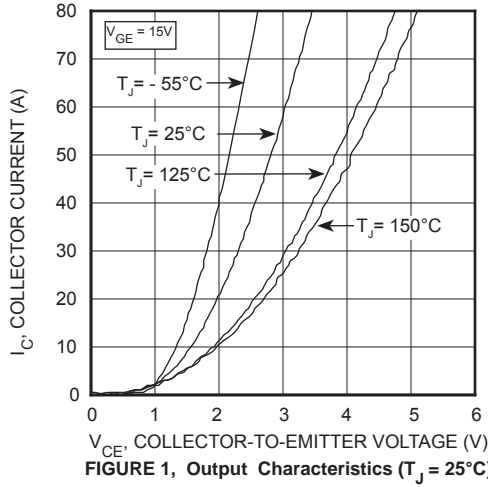

**TYPICAL PERFORMANCE CURVES**

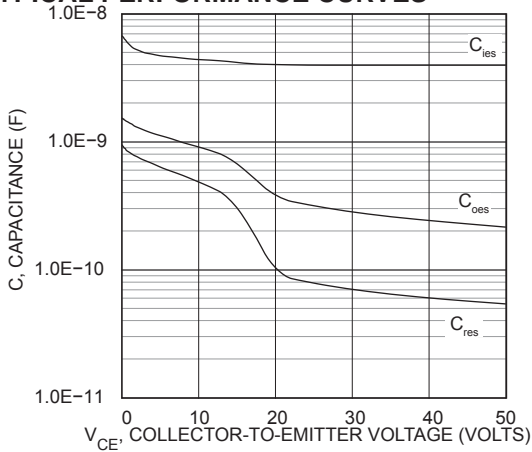

**FIGURE 9, Capacitance vs Collector-To-Emitter Voltage**

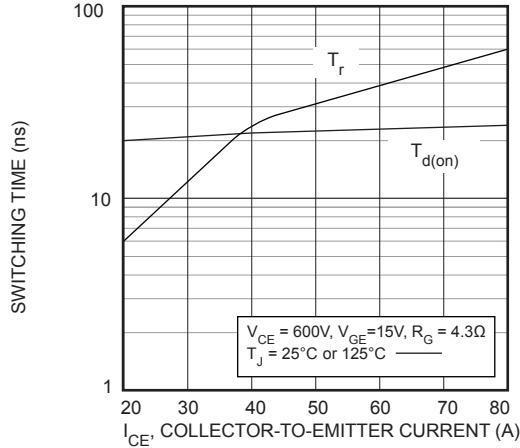

**FIGURE 11, Turn-On Time vs Collector Current**

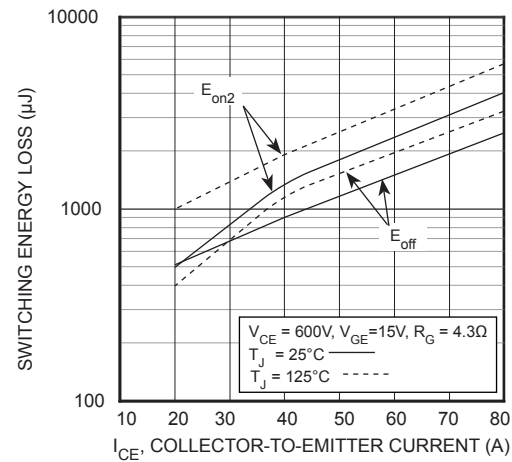

**FIGURE 13, Energy Loss vs Collector Current**

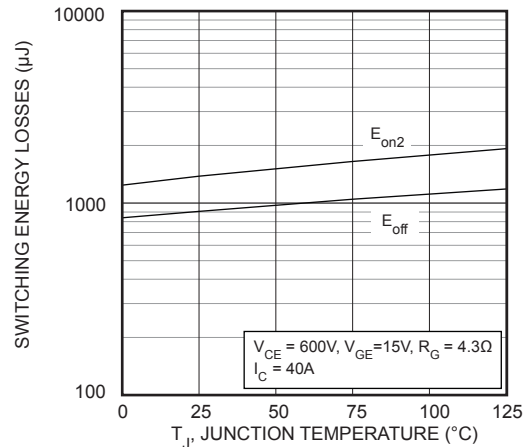

**FIGURE 15, Energy Losses vs Junction Temperature**

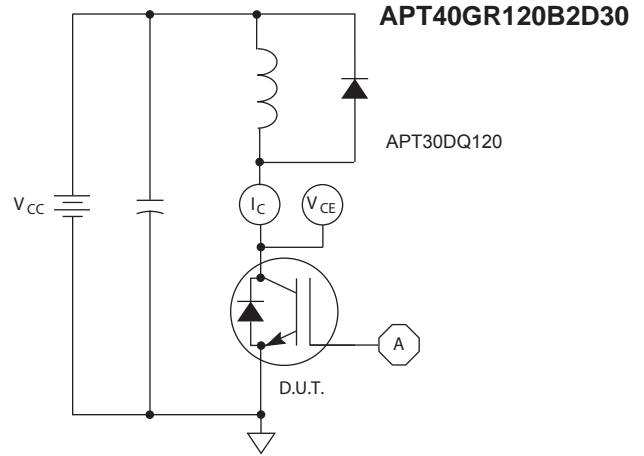

**FIGURE 10, Inductive Switching Test Circuit**

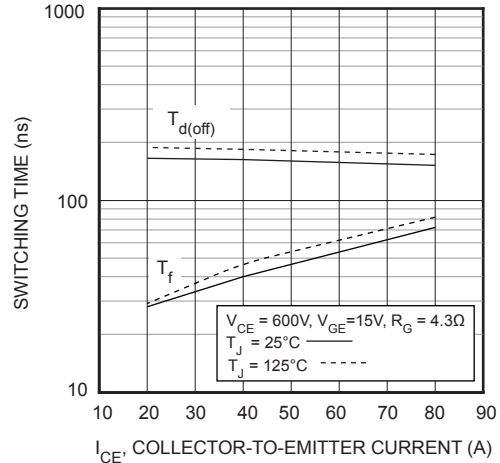

**FIGURE 12, Turn-Off Time vs Collector Current**

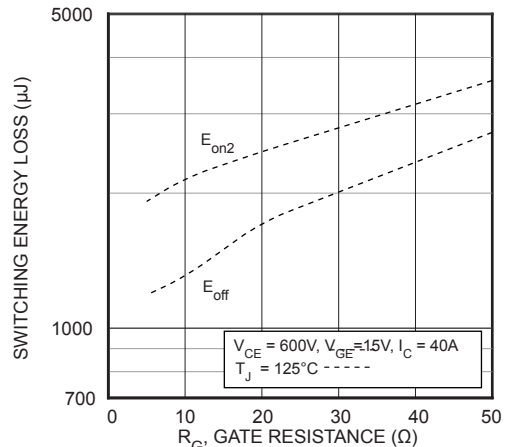

**FIGURE 14, Energy Loss vs Gate Resistance**

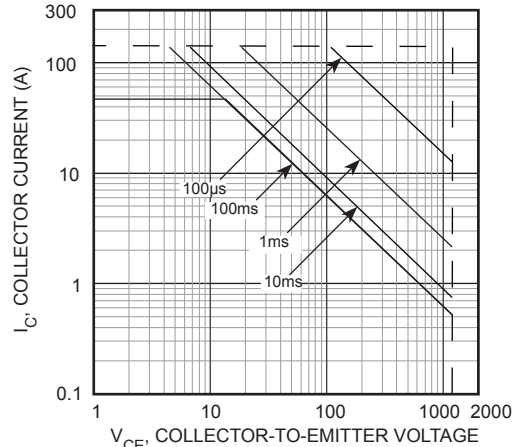

**FIGURE 16, Minimum Switching Safe Operating Area**

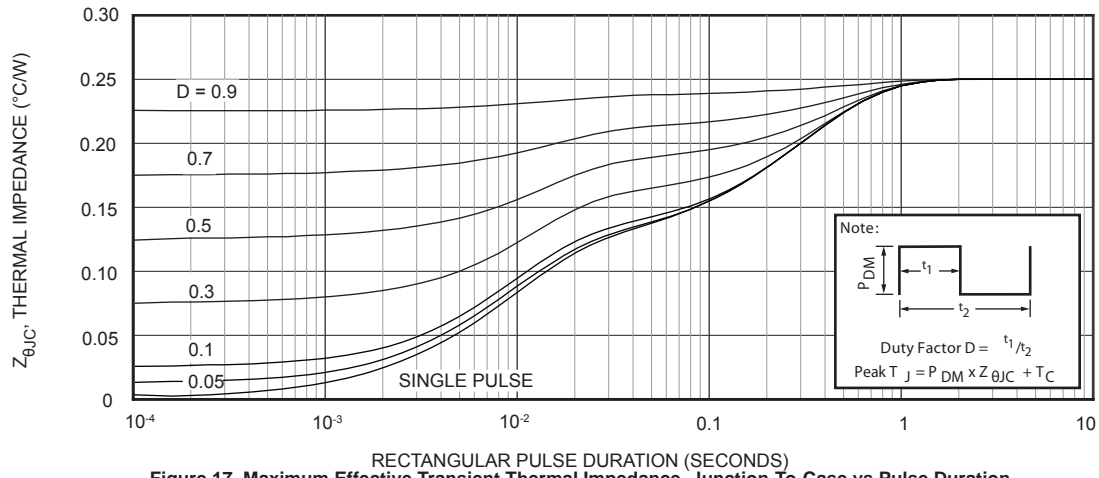

Figure 17, Maximum Effective Transient Thermal Impedance, Junction-To-Case vs Pulse Duration

# ULTRAFAST SOFT RECOVERY ANTI-PARALLEL DIODE

**MAXIMUM RATINGS**

All Ratings:  $T_C = 25^\circ\text{C}$  unless otherwise specified.

Symbol	Characteristic / Test Conditions	APT40GR120B2D30		UNIT
$I_{F(AV)}$	Maximum Average Forward Current ( $T_C = 110^\circ\text{C}$ , Duty Cycle = 0.5)		30	Amps
$I_{F(RMS)}$	RMS Forward Current (Square wave, 50% duty)		43	
$I_{FSM}$	Non-Repetitive Forward Surge Current ( $T_J = 45^\circ\text{C}$ , 8.3ms)		210	

**STATIC ELECTRICAL CHARACTERISTICS**

Symbol	Characteristic / Test Conditions	MIN	TYP	MAX	UNIT
$V_F$	Forward Voltage		$I_F = 30\text{A}$	2.8	Volts
			$I_F = 60\text{A}$	3.4	
			$I_F = 30\text{A}, T_J = 125^\circ\text{C}$	2.1	

**DYNAMIC CHARACTERISTICS**

Symbol	Characteristic	Test Conditions	MIN	TYP	MAX	UNIT
$t_{rr}$	Reverse Recovery Time	$I_F = 1\text{A}, di_F/dt = -100\text{A}/\mu\text{s}, V_R = 30\text{V}, T_J = 25^\circ\text{C}$	-	26		ns
$t_{rr}$	Reverse Recovery Time	$I_F = 30\text{A}, di_F/dt = -200\text{A}/\mu\text{s}, V_R = 800\text{V}, T_C = 25^\circ\text{C}$	-	320		
$Q_{rr}$	Reverse Recovery Charge		-	545		nC
$I_{RRM}$	Maximum Reverse Recovery Current		-	4	-	Amps
$t_{rr}$	Reverse Recovery Time	$I_F = 30\text{A}, di_F/dt = -200\text{A}/\mu\text{s}, V_R = 800\text{V}, T_C = 125^\circ\text{C}$	-	435		ns
$Q_{rr}$	Reverse Recovery Charge		-	2100		nC
$I_{RRM}$	Maximum Reverse Recovery Current		-	9	-	Amps
$t_{rr}$	Reverse Recovery Time	$I_F = 30\text{A}, di_F/dt = -1000\text{A}/\mu\text{s}, V_R = 800\text{V}, T_C = 125^\circ\text{C}$	-	180		ns
$Q_{rr}$	Reverse Recovery Charge		-	2975		nC
$I_{RRM}$	Maximum Reverse Recovery Current		-	28		Amps

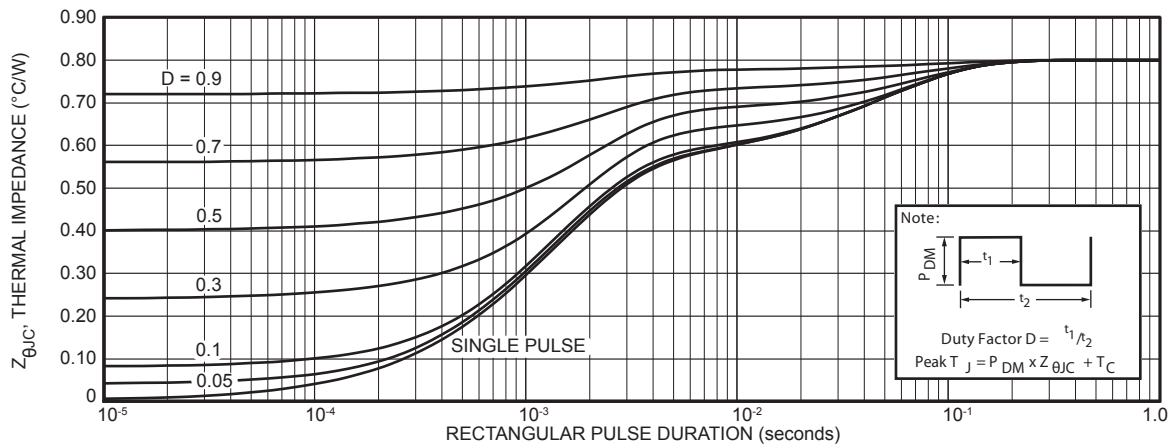

FIGURE 18. MAXIMUM EFFECTIVE TRANSIENT THERMAL IMPEDANCE, JUNCTION-TO-CASE vs. PULSE DURATION

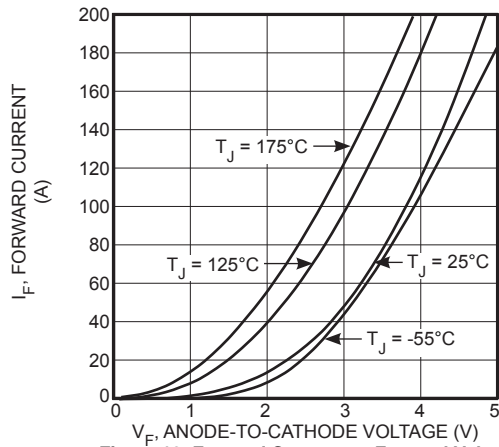

Figure 19. Forward Current vs. Forward Voltage

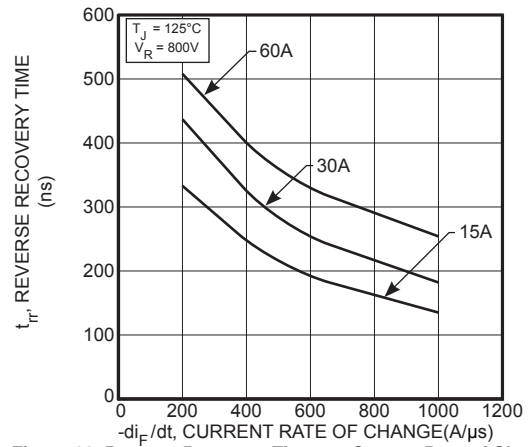

Figure 20. Reverse Recovery Time vs. Current Rate of Change

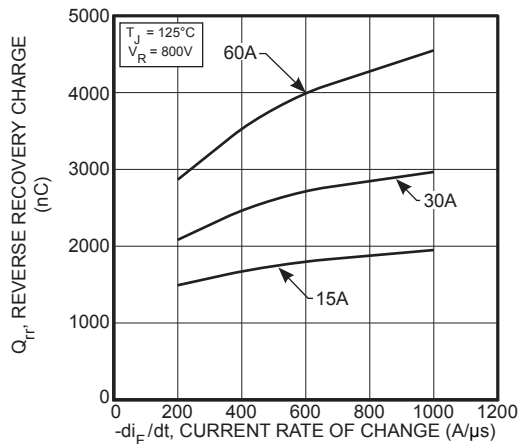

Figure 21. Reverse Recovery Charge vs. Current Rate of Change

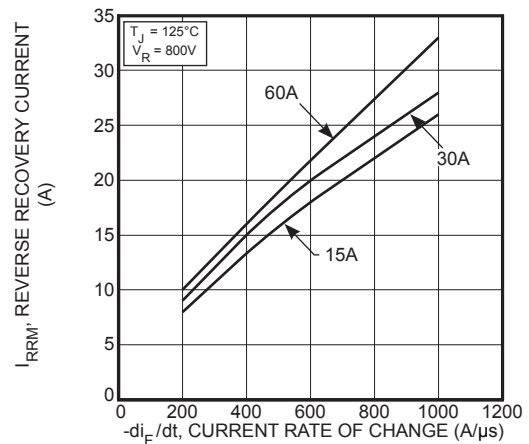

Figure 22. Reverse Recovery Current vs. Current Rate of Change

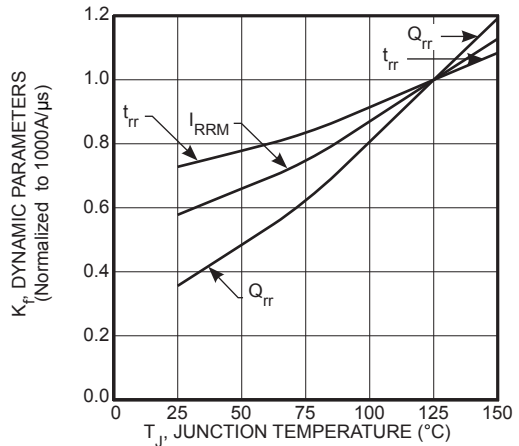

Figure 23. Dynamic Parameters vs. Junction Temperature

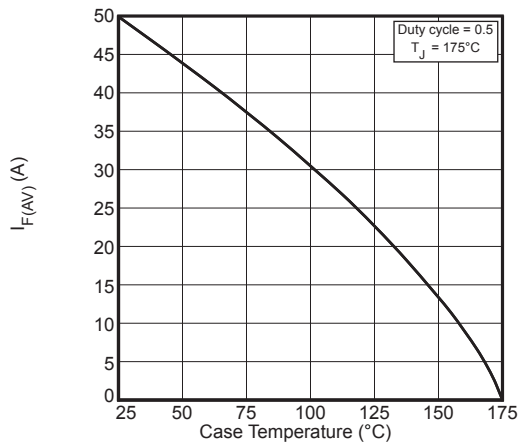

Figure 24. Maximum Average Forward Current vs. Case Temperature

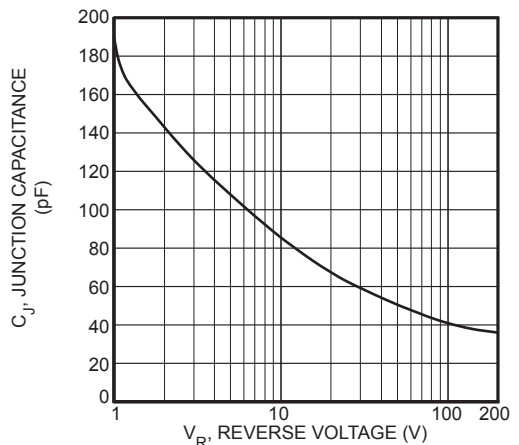

Figure 25. Junction Capacitance vs. Reverse Voltage

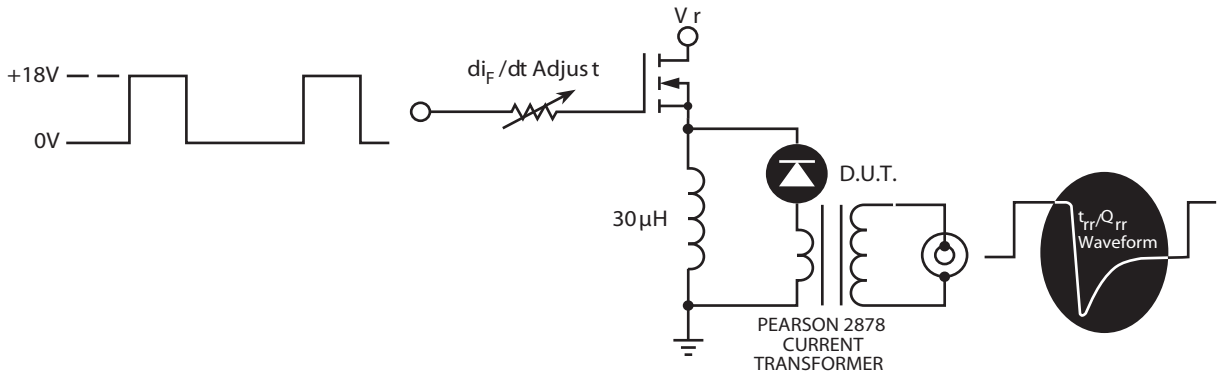

Figure 26. Diode Test Circuit

- 1  $I_F$  - Forward Conduction Current
- 2  $di_F/dt$  - Rate of Diode Current Change Through Zero Crossing.
- 3  $I_{RRM}$  - Maximum Reverse Recovery Current
- 4  $t_{rr}$  - Reverse Recovery Time measured from zero crossing where diode current goes from positive to negative, to the point at which the straight line through  $I_{RRM}$  and  $0.25 I_{RRM}$  passes through zero.
- 5  $Q_{rr}$  - Area Under the Curve Defined by  $I_{RRM}$  and  $t_{RR}$ .

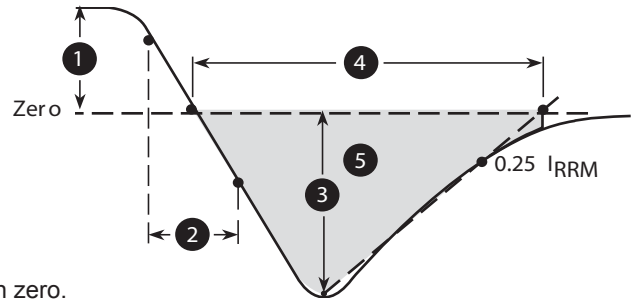
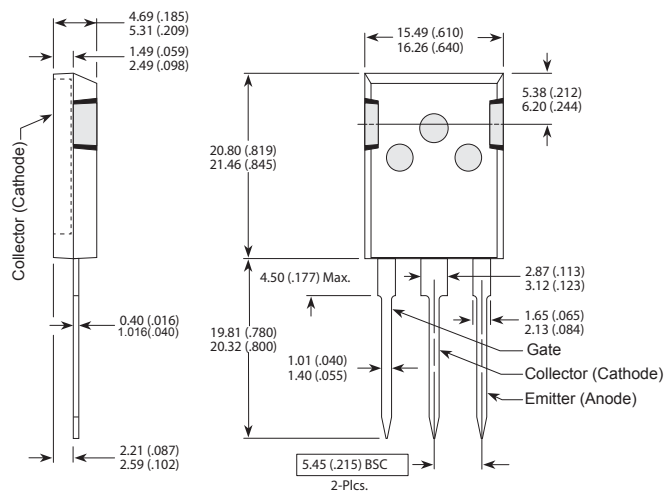

Figure 27. Diode Reverse Recovery Waveform Definition

T-MAX<sup>®</sup> (B2) Package Outline



These dimensions are equal to the TO-247 without the mounting hole.

Dimensions in Millimeters and (Inches)