

Thunderbolt IGBT®

The Thunderbolt IGBT® is a new generation of high voltage power IGBTs. Using Non-Punch Through Technology, the Thunderbolt IGBT® offers superior ruggedness and ultrafast switching speed.

- Low Forward Voltage Drop
- High Freq. Switching to 50KHz
- Low Tail Current
- Ultra Low Leakage Current
- RBSOA and SCSOA Rated

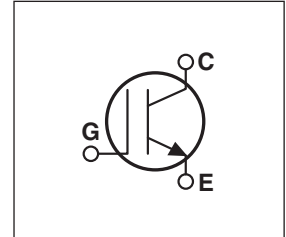
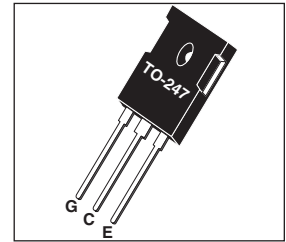

MAXIMUM RATINGS

All Ratings: $T_C = 25^\circ\text{C}$ unless otherwise specified.

Symbol	Parameter	APT25GT120BR(G)	UNIT
V_{CES}	Collector-Emitter Voltage	1200	Volts
V_{GE}	Gate-Emitter Voltage	± 30	
I_{C1}	Continuous Collector Current @ $T_C = 25^\circ\text{C}$	54	Amps
I_{C2}	Continuous Collector Current @ $T_C = 110^\circ\text{C}$	25	
I_{CM}	Pulsed Collector Current ^①	75	
SSOA	Switching Safe Operating Area @ $T_J = 150^\circ\text{C}$	75A @ 1200V	
P_D	Total Power Dissipation	347	Watts
T_J, T_{STG}	Operating and Storage Junction Temperature Range	-55 to 150	°C
T_L	Max. Lead Temp. for Soldering: 0.063" from Case for 10 Sec.	300	

STATIC ELECTRICAL CHARACTERISTICS

Symbol	Characteristic / Test Conditions	MIN	TYP	MAX	Units
$V_{(BR)CES}$	Collector-Emitter Breakdown Voltage ($V_{GE} = 0V, I_C = 1.5mA$)	1200			Volts
$V_{GE(TH)}$	Gate Threshold Voltage ($V_{CE} = V_{GE}, I_C = 1mA, T_J = 25^\circ\text{C}$)	4.5	5.5	6.5	
$V_{CE(ON)}$	Collector-Emitter On Voltage ($V_{GE} = 15V, I_C = 25A, T_J = 25^\circ\text{C}$)	2.7	3.2	3.7	
	Collector-Emitter On Voltage ($V_{GE} = 15V, I_C = 25A, T_J = 125^\circ\text{C}$)		3.9		
I_{CES}	Collector Cut-off Current ($V_{CE} = 1200V, V_{GE} = 0V, T_J = 25^\circ\text{C}$) ^②			100	μA
	Collector Cut-off Current ($V_{CE} = 1200V, V_{GE} = 0V, T_J = 125^\circ\text{C}$) ^②			TBD	
I_{GES}	Gate-Emitter Leakage Current ($V_{GE} = \pm 20V$)			120	nA

 **CAUTION:** These Devices are Sensitive to Electrostatic Discharge. Proper Handling Procedures Should Be Followed.

DYNAMIC CHARACTERISTICS

APT25GT120BR(G)

Symbol	Characteristic	Test Conditions	MIN	TYP	MAX	UNIT
C_{ies}	Input Capacitance	Capacitance $V_{GE} = 0V, V_{CE} = 25V$ $f = 1 \text{ MHz}$		1650		pF
C_{oes}	Output Capacitance			250		
C_{res}	Reverse Transfer Capacitance			110		
V_{GEP}	Gate-to-Emitter Plateau Voltage	Gate Charge		10.0		V
Q_g	Total Gate Charge ^③	$V_{GE} = 15V$ $V_{CE} = 600V$ $I_C = 25A$		170		nC
Q_{ge}	Gate-Emitter Charge			20		
Q_{gc}	Gate-Collector ("Miller") Charge			100		
SSOA	Switching Safe Operating Area	$T_J = 150^\circ\text{C}, R_G = 5\Omega, V_{GE} = 15V, L = 100\mu\text{H}, V_{CE} = 1200V$	75			A
$t_{d(on)}$	Turn-on Delay Time	Inductive Switching (25°C) $V_{CC} = 800V$ $V_{GE} = 15V$ $I_C = 25A$ $R_G = 5\Omega$ $T_J = +25^\circ\text{C}$		14		ns
t_r	Current Rise Time			27		
$t_{d(off)}$	Turn-off Delay Time			150		
t_f	Current Fall Time			36		
E_{on1}	Turn-on Switching Energy ^④			930		
E_{on2}	Turn-on Switching Energy (Diode) ^⑤		1860			
E_{off}	Turn-off Switching Energy ^⑥		720			
$t_{d(on)}$	Turn-on Delay Time	Inductive Switching (125°C) $V_{CC} = 800V$ $V_{GE} = 15V$ $I_C = 25A$ $R_G = 5\Omega$ $T_J = +125^\circ\text{C}$		14		ns
t_r	Current Rise Time			27		
$t_{d(off)}$	Turn-off Delay Time			175		
t_f	Current Fall Time			45		
E_{on1}	Turn-on Switching Energy ^④			925		
E_{on2}	Turn-on Switching Energy (Diode) ^⑤		3265			
E_{off}	Turn-off Switching Energy ^⑥		965			

THERMAL AND MECHANICAL CHARACTERISTICS

Symbol	Characteristic	MIN	TYP	MAX	UNIT
$R_{\theta JC}$	Junction to Case (IGBT)			.36	°C/W
$R_{\theta JC}$	Junction to Case (DIODE)			N/A	
W_T	Package Weight		5.9		gm

① Repetitive Rating: Pulse width limited by maximum junction temperature.

② For Combi devices, I_{ces} includes both IGBT and FRED leakages

③ See MIL-STD-750 Method 3471.

④ E_{on1} is the clamped inductive turn-on energy of the IGBT only, without the effect of a commutating diode reverse recovery current adding to the IGBT turn-on loss. Tested in inductive switching test circuit shown in figure 21, but with a Silicon Carbide diode.

⑤ E_{on2} is the clamped inductive turn-on energy that includes a commutating diode reverse recovery current in the IGBT turn-on switching loss. (See Figures 21, 22.)

⑥ E_{off} is the clamped inductive turn-off energy measured in accordance with JEDEC standard JESD24-1. (See Figures 21, 23.)

APT Reserves the right to change, without notice, the specifications and information contained herein.

TYPICAL PERFORMANCE CURVES

APT25GT120BR(G)

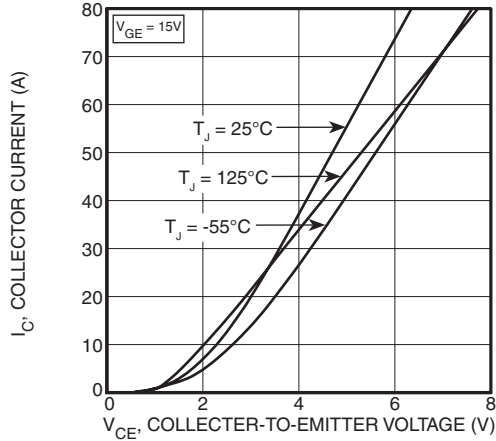

FIGURE 1, Output Characteristics ($T_J = 25^\circ\text{C}$)

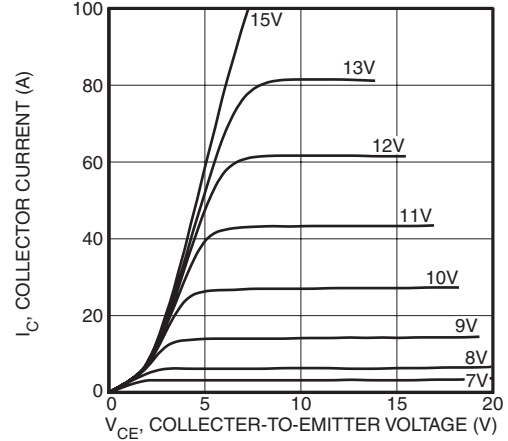

FIGURE 2, Output Characteristics ($T_J = 125^\circ\text{C}$)

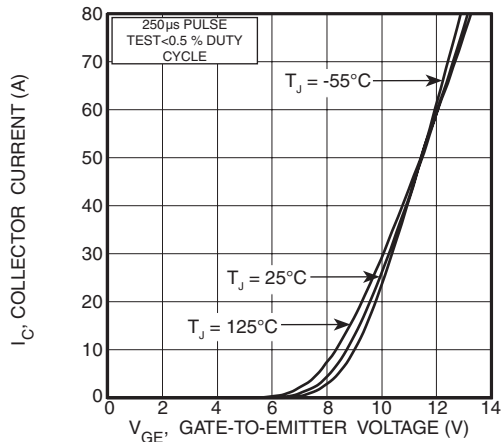

FIGURE 3, Transfer Characteristics

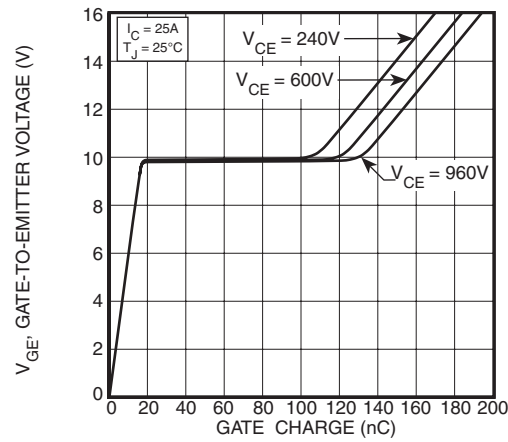

FIGURE 4, Gate Charge

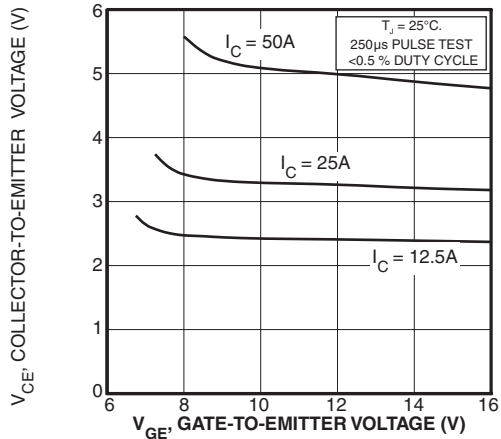

FIGURE 5, On State Voltage vs Gate-to-Emitter Voltage

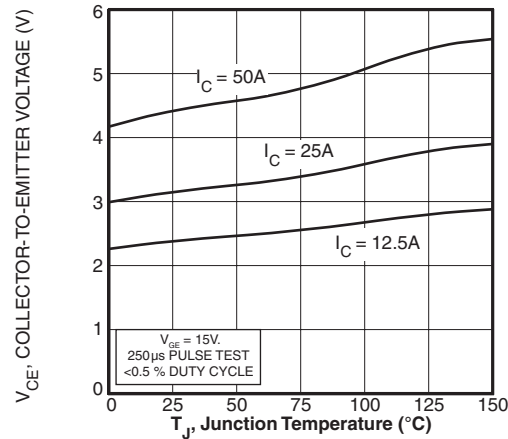

FIGURE 6, On State Voltage vs Junction Temperature

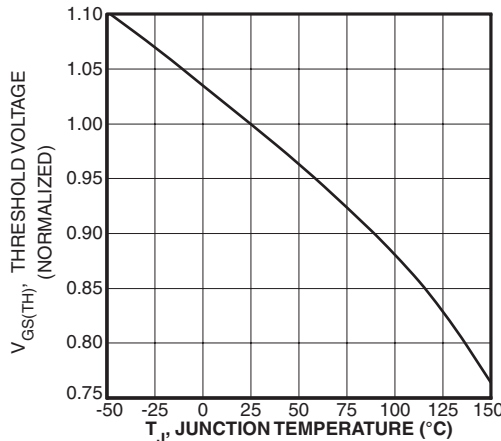

FIGURE 7, Threshold Voltage vs. Junction Temperature

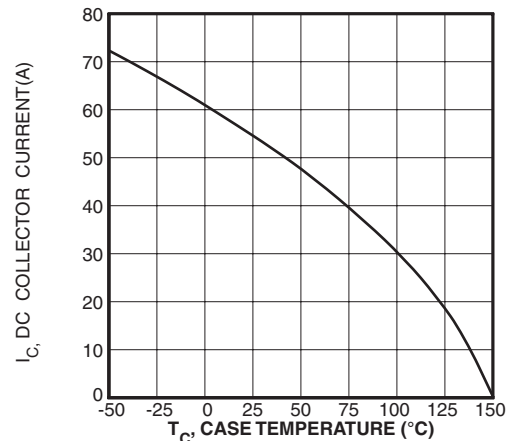

FIGURE 8, DC Collector Current vs Case Temperature

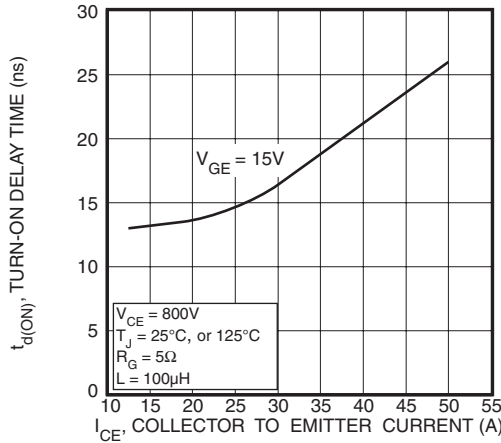

FIGURE 9, Turn-On Delay Time vs Collector Current

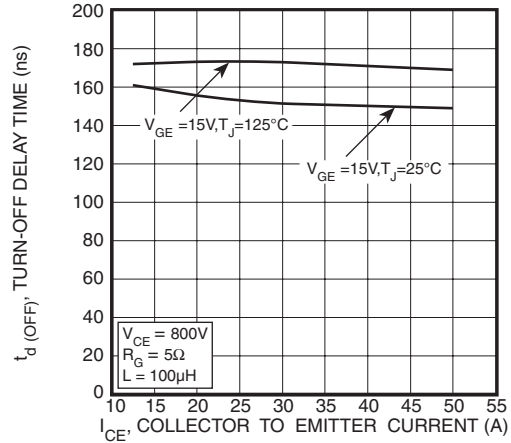

FIGURE 10, Turn-Off Delay Time vs Collector Current

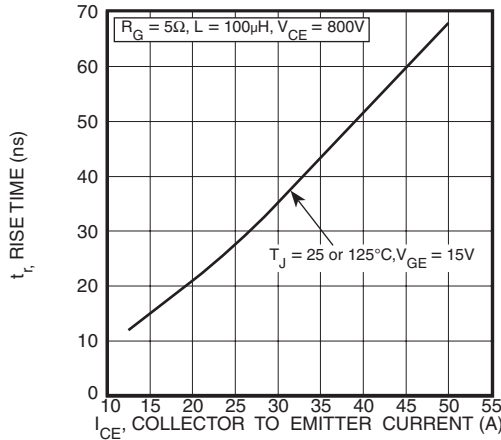

FIGURE 11, Current Rise Time vs Collector Current

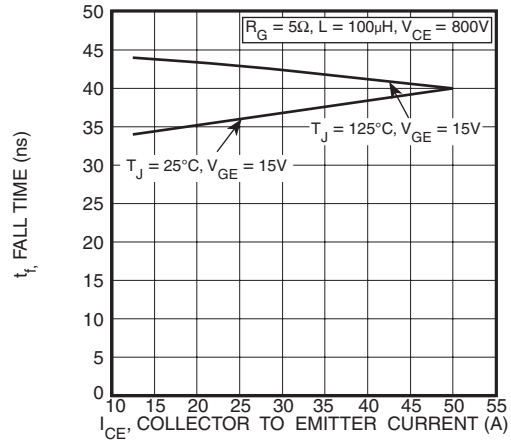

FIGURE 12, Current Fall Time vs Collector Current

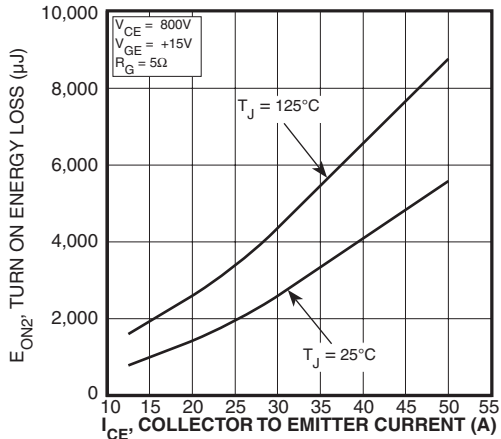

FIGURE 13, Turn-On Energy Loss vs Collector Current

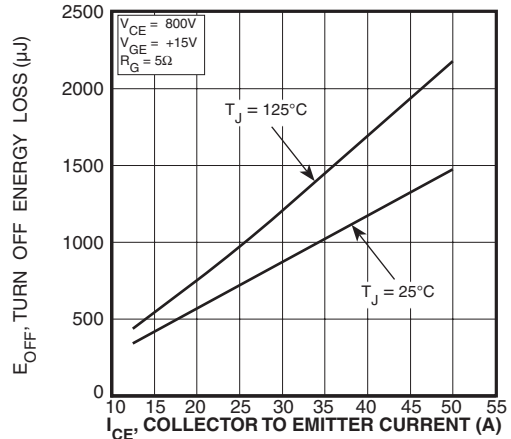

FIGURE 14, Turn Off Energy Loss vs Collector Current

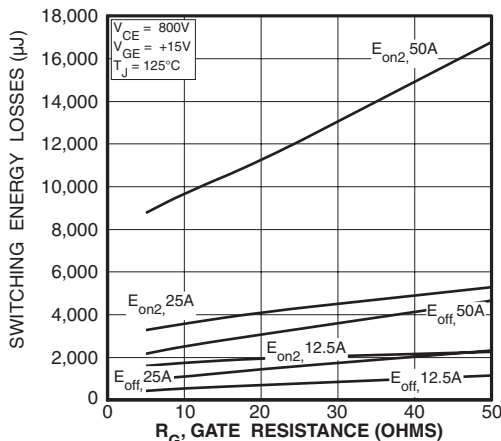

FIGURE 15, Switching Energy Losses vs. Gate Resistance

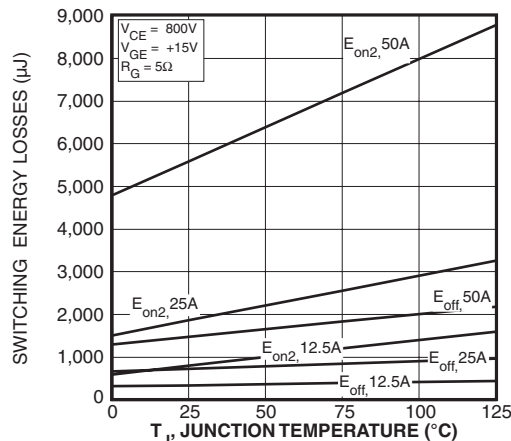

FIGURE 16, Switching Energy Losses vs Junction Temperature

TYPICAL PERFORMANCE CURVES

APT25GT120BR(G)

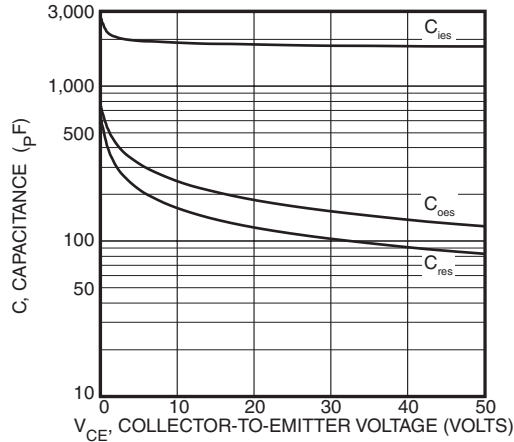

Figure 17, Capacitance vs Collector-To-Emitter Voltage

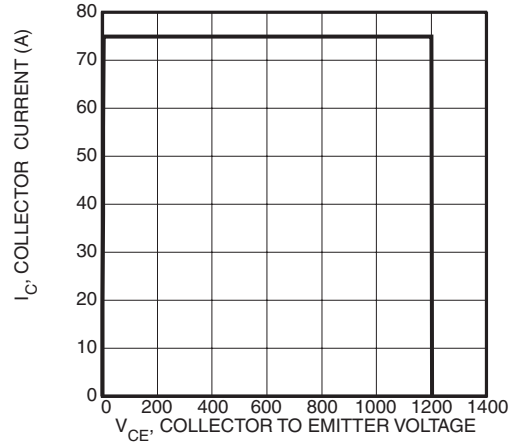

Figure 18, Minimum Switching Safe Operating Area

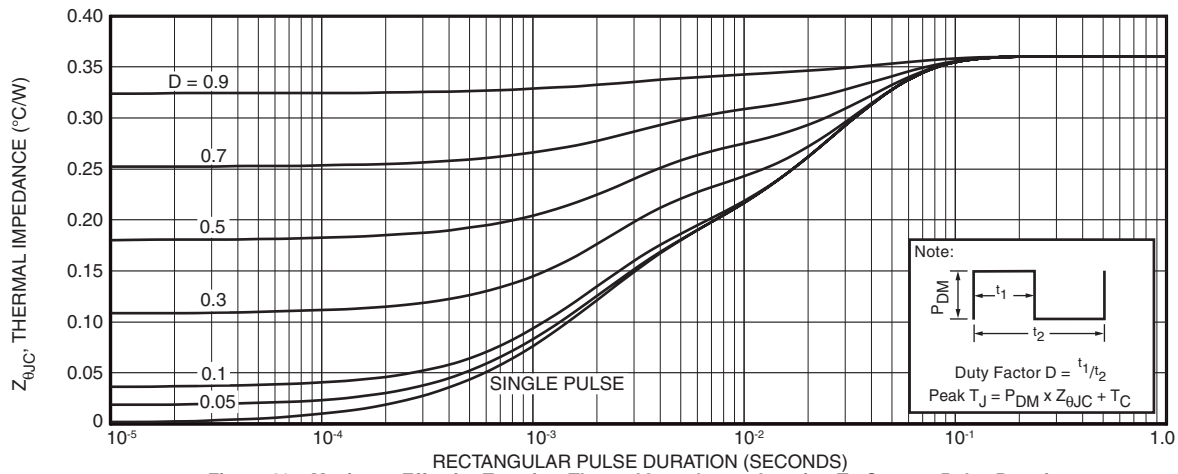

Figure 19a, Maximum Effective Transient Thermal Impedance, Junction-To-Case vs Pulse Duration

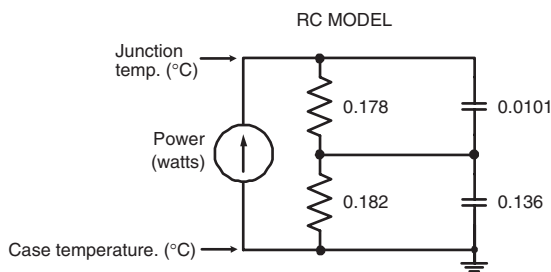

FIGURE 19b, TRANSIENT THERMAL IMPEDANCE MODEL

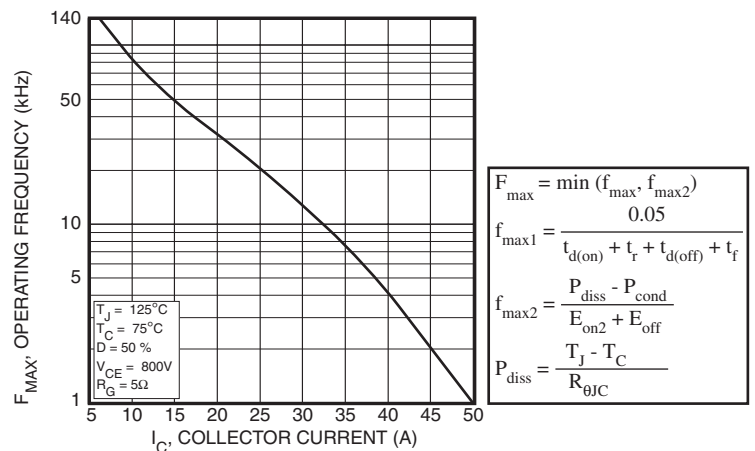

Figure 20, Operating Frequency vs Collector Current

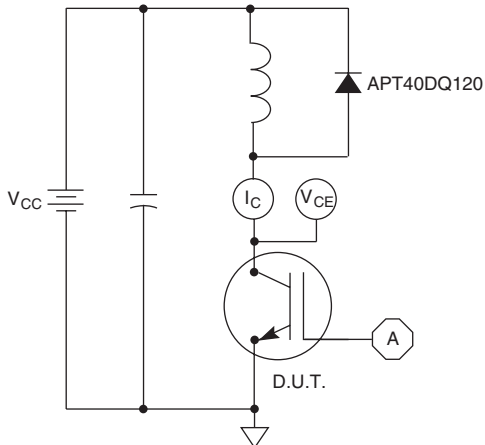

Figure 21, Inductive Switching Test Circuit

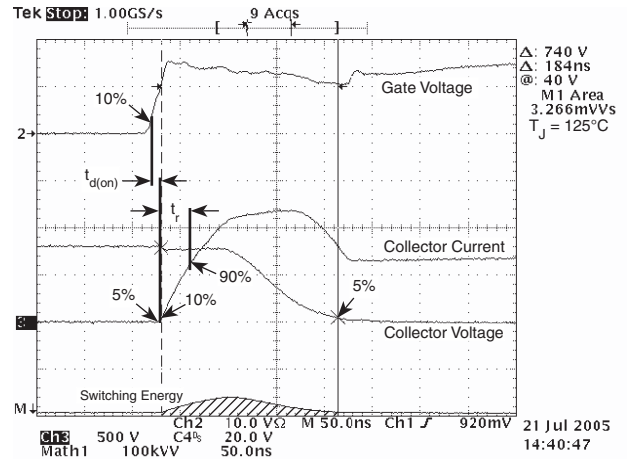

Figure 22, Turn-on Switching Waveforms and Definitions

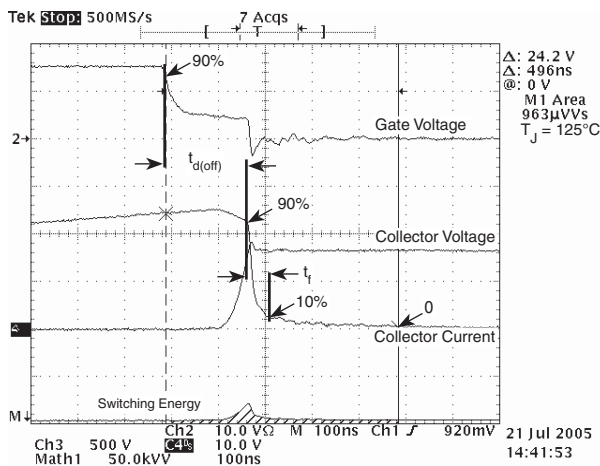
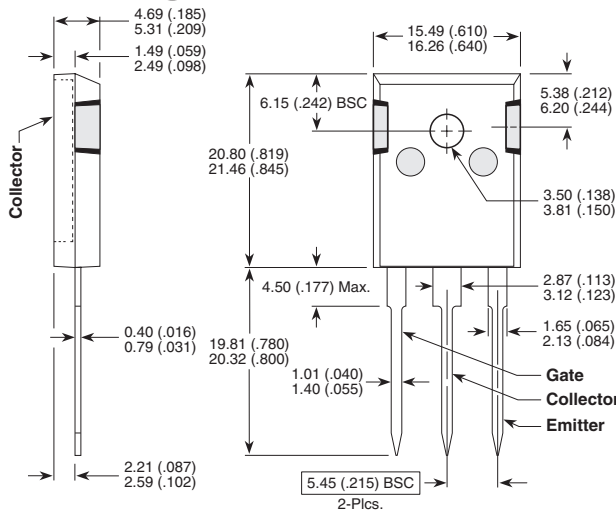

Figure 23, Turn-off Switching Waveforms and Definitions

TO-247 Package Outline

Ⓢ SAC: Tin, Silver, Copper



Dimensions in Millimeters and (Inches)