

External MIMO 4x5G NR Dome Antenna



AECR1808X4

Request Samples



Check Inventory



189 x 182 x 85 mm
RoHS/RoHS II Compliant
MSL Level = 1

Features

- Wide band : 600 MHz ~ 6 GHz
- MIMO 4x 5G NR/4G LTE
- Global 4G/LTE cellular band coverage including CAT M and NB-IoT
- 4 dBi Gain
- IP67 rated
- Screw Mount solution
- Fully customizable RF cable and connector options

Applications

- 5G
- IoT
- M2M
- Smart City
- Transportation
- Smart Agriculture
- Geolocation and Tracking
- 5G NR, CBRS, Private LTE, 4G LTE applications

Product Image



External MIMO 4x5G NR Dome Antenna



AECR1808X4

Request Samples



Check Inventory



189 x 182 x 85 mm
RoHS/RoHS II Compliant
 MSL Level = 1

Part Number Builder

AECR1808X4 - □□□□□

Color / UV Coating	
Code	Description
S (Standard)	Black without UV coating
A	Black with UV Coating
B	White without UV Coating
C	White with UV Coating

Cable length in 'mm'	
Maximum cable length supported : LMR-100 (up to 3000 mm)	
Code	Description
3000 (Standard)	3000 mm
Other Examples :	
0200	200 mm
2000	2000 mm

Cable Type & Connector Type		
Code	Cable Type	Connector Type
S (Standard)	LMR-100	SMA (M)
A		FAKRA-D (F)
B		RP-SMA (M)
C		SMB (M)
D		N-Type (M)
E		TNC (M)
F		BNC (M)
G		MCX (M)
H		MMCX (M)
I		FME (M)
J		FME (F)

Example Configurations :

Part Number	UV Protection Coating / Color	Cable length	Cable Type / Connector Type
AECR1808X4 S-3000S	No / Black	3000 mm	4xLMR-100 with 4xSMA (M) for 5G NR (Standard)
AECR1808X4 A-1000A	Yes / Black	1000 mm	4xLMR-100 with 4xFAKRA-D (F) for 5G NR

Note :

- For the standard part number (AECR1808X4**S-3000S**), please refer to the packaging at the end of the document.
- For additional configuration (AECR1808X4□ - □□□□□□), MOQs, pricing and packaging changes may be applicable.



5101 Hidden Creek Ln Spicewood TX 78669
 Phone: 512-371-6159 | Fax: 512-351-8858
 For terms and conditions of sales, please visit:
www.abracon.com

REVISED: 01-03-20

ABRACON IS
 ISO9001-2015
 CERTIFIED

External MIMO 4x5G NR Dome Antenna



AECR1808X4

Request Samples



Check Inventory



189 x 182 x 85 mm
RoHS/RoHS II Compliant
MSL Level = 1

Electrical Specification

Parameter	Specification			Unit
	Min	Typ	Max	
MIMO 4x 5G NR (Main + Aux)				
Operating Frequency	600		6000	MHz
VSWR			4.0	
Peak Gain			4	dBi
Impedance		50		Ω
Polarization	Linear			
Power Rating			10	W

Mechanical Specification

Parameter	Specification	
Antenna Dimension	189 x 182 x 85 mm	
Material	PC + ABS	
Mounting Type	Screw	
RF Cable Type	4 x LMR100	
RF Cable Length	3 m	
RF Connector	4x SMA (M)	
Mounting Torque	Recommended	1.5 ~ 3 Nm
	Maximum	5 Nm

Environmental Specification

Parameter	Specification
Operating Temperature	-40°C to +85°C
Storage Temperature	-40°C to +85°C
IP Rating	IP67 (Excluding Cable Outlet)
UL Rating	UL-HB
RoHS Compliance	Yes
PB Free	Yes
MSL	1
ESD Sensitive	Yes
Relative Humidity	Up to 95%
Vibration	10 ~ 55 Hz with 1.5 mm amplitude 2 hrs



5101 Hidden Creek Ln Spicewood TX 78669
 Phone: 512-371-6159 | Fax: 512-351-8858
 For terms and conditions of sales, please visit:
www.abracon.com

REVISED: 01-03-20

ABRACON IS
 ISO9001-2015
 CERTIFIED

External MIMO 4x5G NR Dome Antenna



AECR1808X4

Request Samples



Check Inventory



189 x 182 x 85 mm
RoHS/RoHS II Compliant
MSL Level = 1

Product Dimension

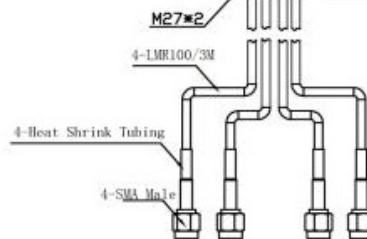
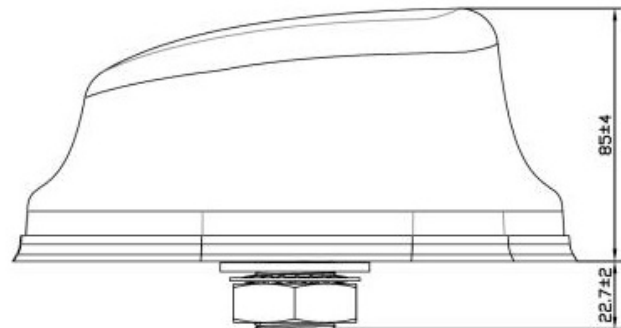
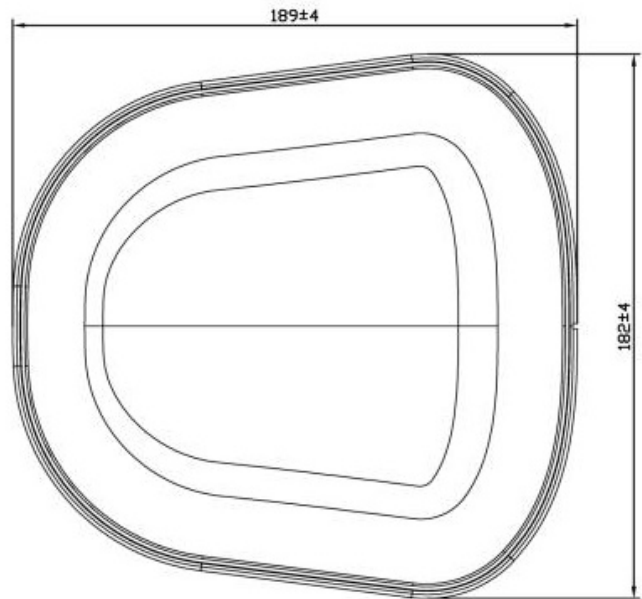
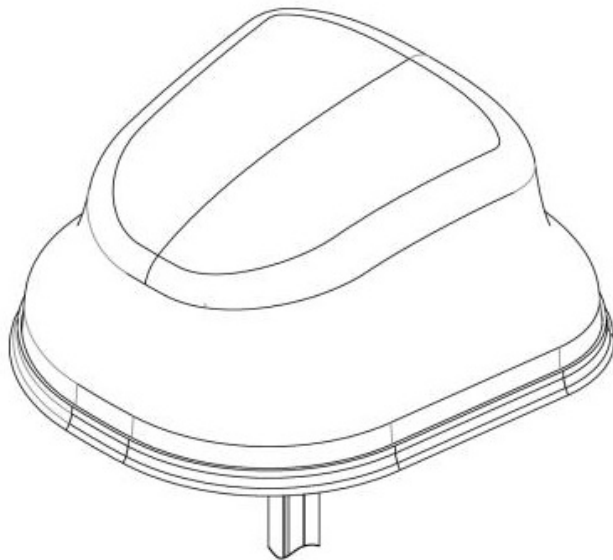

Unit : mm



5101 Hidden Creek Ln Spicewood TX 78669
Phone: 512-371-6159 | Fax: 512-351-8858
For terms and conditions of sales, please visit:
www.abracon.com

REVISED: 01-03-20

ABRACON IS
ISO9001-2015
CERTIFIED

External MIMO 4x5G NR Dome Antenna



AECR1808X4

Request Samples



Check Inventory



189 x 182 x 85 mm
RoHS/RoHS II Compliant
MSL Level = 1

Test Measurement - VSWR

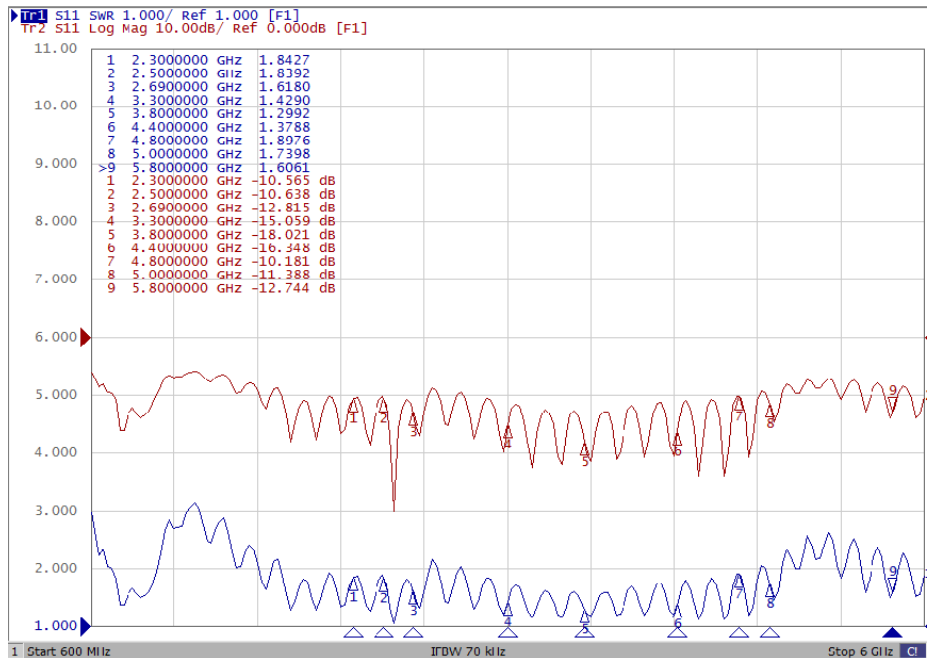
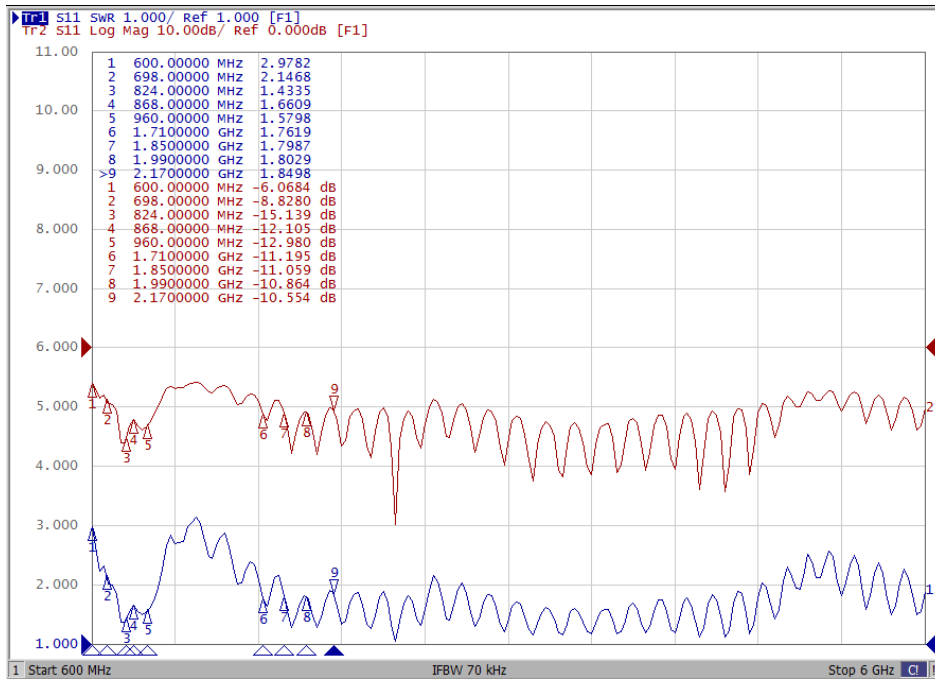

5101 Hidden Creek Ln Spicewood TX 78669
 Phone: 512-371-6159 | Fax: 512-351-8858
 For terms and conditions of sales, please visit:
www.abracon.com

REVISED: 01-03-20

ABRACON IS
 ISO9001-2015
 CERTIFIED

External MIMO 4x5G NR Dome Antenna



AECR1808X4

Request Samples



Check Inventory



189 x 182 x 85 mm
RoHS/RoHS II Compliant
MSL Level = 1

Radiation Characteristics

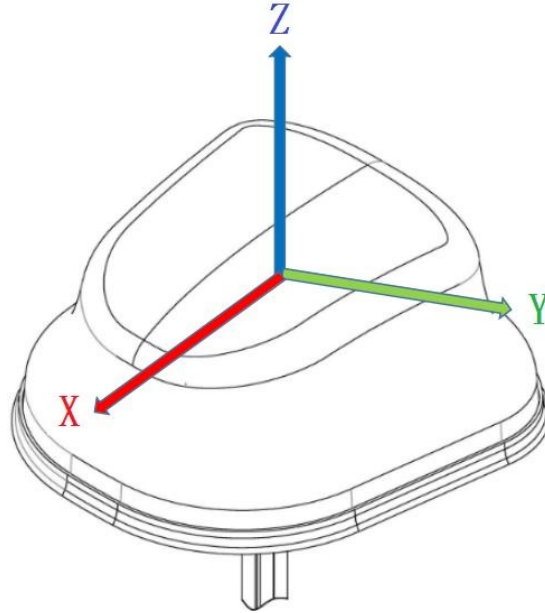

External MIMO 4x5G NR Dome Antenna



AECR1808X4

Request Samples



Check Inventory



189 x 182 x 85 mm
RoHS/RoHS II Compliant
MSL Level = 1

4x 5G NR : Main & Aux

2D Pattern

XY - Plane

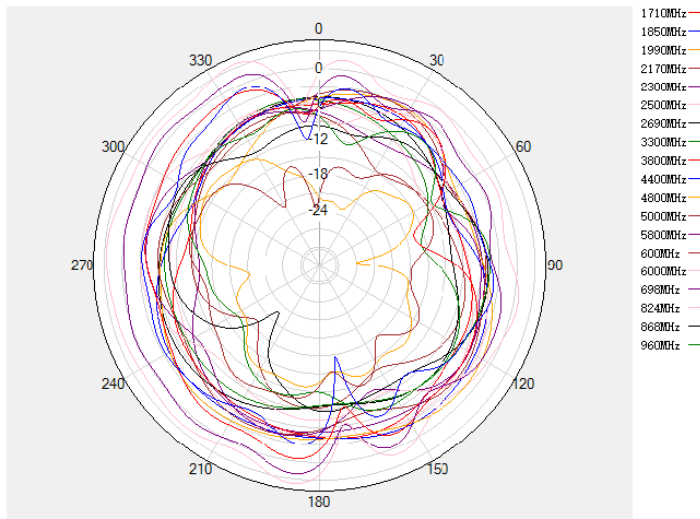

XZ - Plane

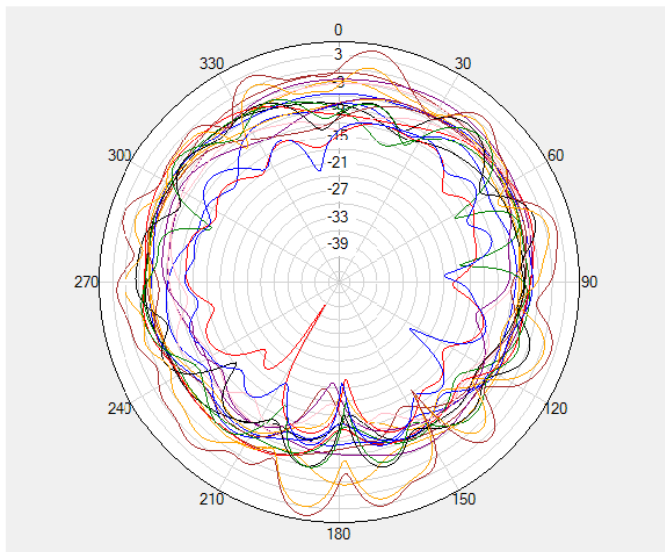

YZ - Plane

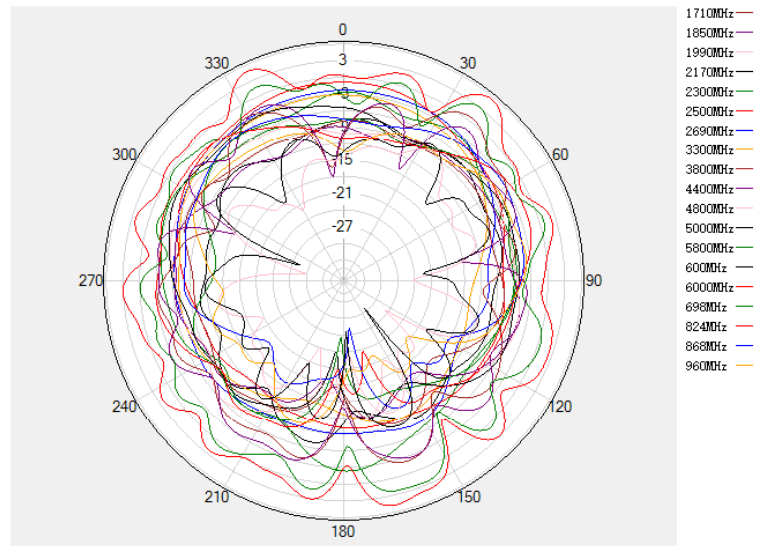

5101 Hidden Creek Ln Spicewood TX 78669
Phone: 512-371-6159 | Fax: 512-351-8858
For terms and conditions of sales, please visit:
www.abracon.com

REVISED: 01-03-20

ABRACON IS
ISO9001-2015
CERTIFIED

External MIMO 4x5G NR Dome Antenna



AECR1808X4

Request Samples



Check Inventory



189 x 182 x 85 mm
RoHS/RoHS II Compliant
MSL Level = 1

3D Pattern

600 MHz

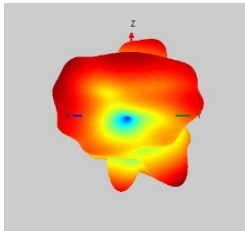

698 MHz

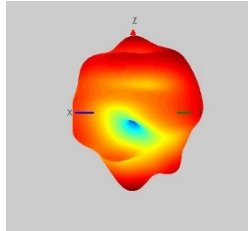

824 MHz

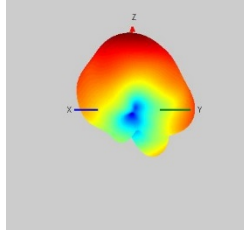

868 MHz

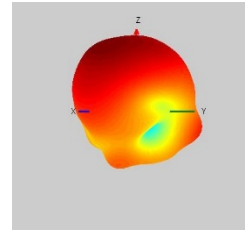

960 MHz

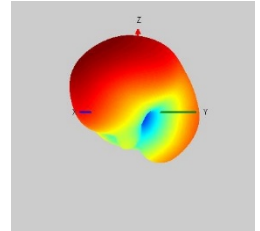

1710 MHz

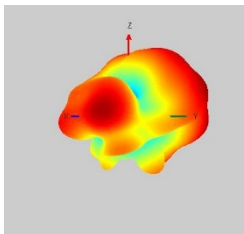

1850 MHz

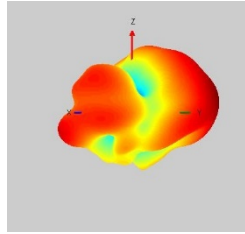

1990 MHz

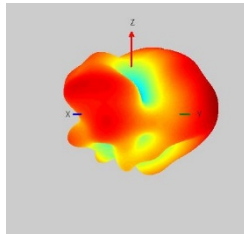

2170 MHz

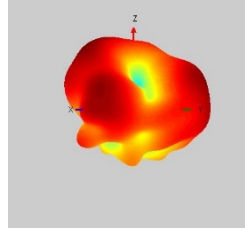

2300 MHz

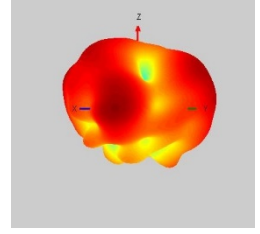

2500 MHz

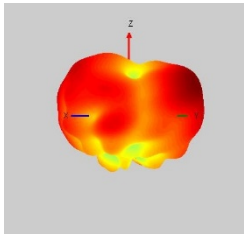

2690 MHz

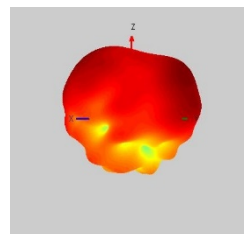

3300 MHz

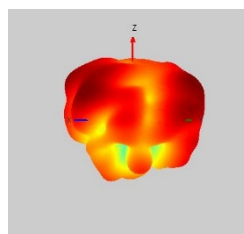

3800 MHz

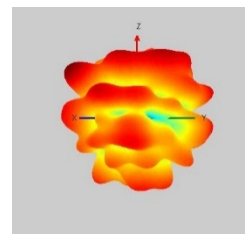

4400 MHz

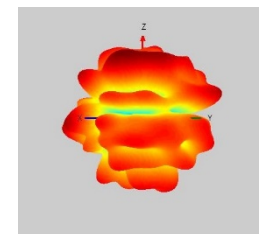

4800 MHz

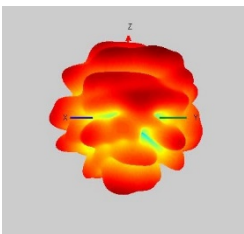

5000 MHz

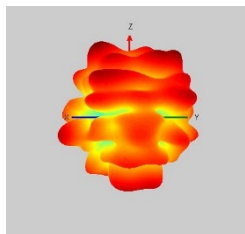

5800 MHz

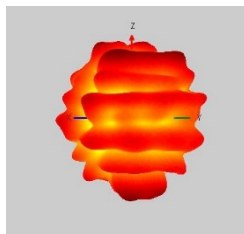

6000 MHz

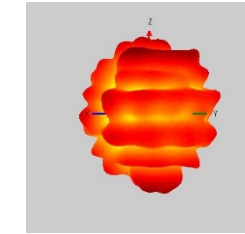

5101 Hidden Creek Ln Spicewood TX 78669
Phone: 512-371-6159 | Fax: 512-351-8858
For terms and conditions of sales, please visit:
www.abracon.com

REVISED: 01-03-20

ABRACON IS
ISO9001-2015
CERTIFIED

External MIMO 4x5G NR Dome Antenna



AECR1808X4

Request Samples



Check Inventory



189 x 182 x 85 mm
RoHS/RoHS II Compliant
MSL Level = 1

Efficiency & Gain

Frequency (MHz)	Efficiency	Gain (dBi)
MIMO 4x5G (Main + Aux)		
600	0.61	1.05
698	0.67	1.88
824	0.68	2.02
868	0.59	1.47
960	0.66	1.58
1710	0.59	1.03
1850	0.57	0.89
1990	0.59	0.77
2170	0.65	3.29
2300	0.63	2.57
2500	0.66	3.05
2690	0.67	1.38
3300	0.54	-0.27
3800	0.53	3.78
4400	0.66	2.08
4800	0.56	-0.19
5000	0.59	-0.62
5800	0.63	4.14
6000	0.62	4.05

Packaging Information

Number of Antenna/ Carton : 8 pcs
Dimension of the Carton : 430 x 430 x 340 mm
Weight of 1 pc of antenna : 950 g
Weight of the Carton : 9 kg

ATTENTION: Abracon LLC's products are COTS – Commercial-Off-The-Shelf products; suitable for Commercial, Industrial and, where designated, Automotive Applications. Abracon's products are not specifically designed for Military, Aviation, Aerospace, Life-dependent Medical applications or any application requiring high reliability where component failure could result in loss of life and/or property. For applications requiring high reliability and/or presenting an extreme operating environment, written consent and authorization from Abracon LLC is required. Please contact Abracon LLC for more information.



5101 Hidden Creek Ln Spicewood TX 78669
Phone: 512-371-6159 | Fax: 512-351-8858
For terms and conditions of sales, please visit:
www.abracon.com

REVISED: 01-03-20

ABRACON IS
ISO9001-2015
CERTIFIED