

5G/4G/LTE - External Blade Antenna

AECB1102X

Request Samples



Check Inventory



115.6 x 21.7 x 5.8 mm
RoHS/RoHS II Compliant
MSL Level = 1

Features

- 600 MHz ~ 6GHz
- 5G NR, CBRS, Private LTE Bands
- Low profile of 5.8 mm
- Easy installation with adhesive tape
- Fully customizable RF cable & connector options

Applications

- IoT
- M2M
- Smart Grid
- Vending Machines
- Gateways & Routers
- Security / Remote Monitoring
- Transportation/ Connected/ Autonomous Vehicles

Product Dimension

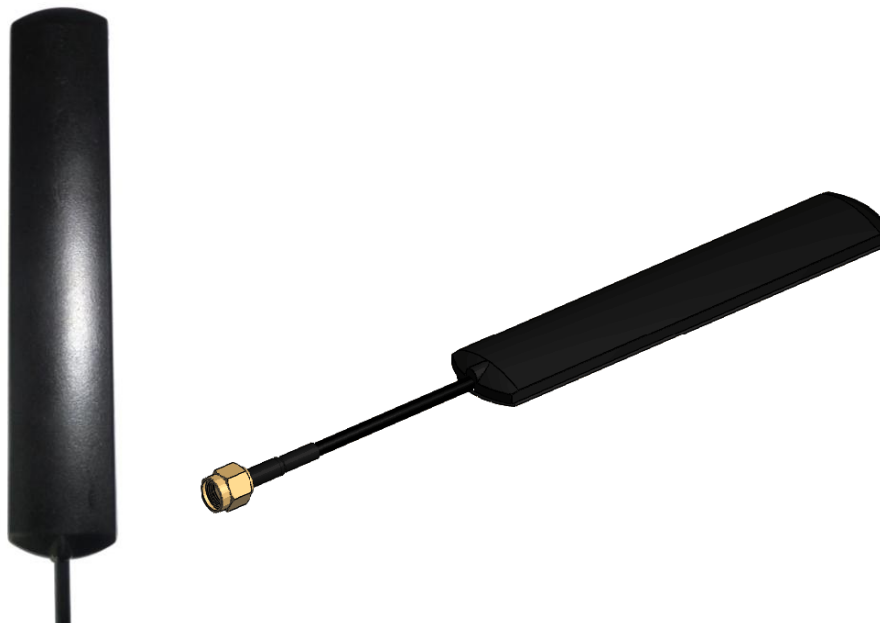

5101 Hidden Creek Ln Spicewood TX 78669
Phone: 512-371-6159 | Fax: 512-351-8858
For terms and conditions of sales, please visit:
www.abracon.com

REVISED: 03-17-21

ABRACON IS
ISO9001-2015
CERTIFIED

5G/4G/LTE - External Blade Antenna

AECB1102X

Request Samples



Check Inventory



115.6 x 21.7 x 5.8 mm
RoHS/RoHS II Compliant
MSL Level = 1

Part Number Builder

AECB1102X -

Color / IP Rating / UV Coating			
Code	Color	IP Rating (excluding cable outlet)	UV Protective Coating
S (Standard)	Black	No	No
A	Black	IP66	No
B	Black	No	Yes
C	Black	IP66	Yes
D	White	No	No
E	White	IP66	No
F	White	No	Yes
G	White	IP66	Yes

Cable length in 'mm'	
Maximum cable length supported : LMR-100 (up to 5000 mm)	
Code	Description
3000 (Standard)	3000 mm
Other Examples :	
0200	200 mm
2000	2000 mm

Cable Type & Connector Type		
Code	Cable Type	Connector Type
S (Standard)	LMR-100	SMA (M)
A		FAKRA-D (F)
B		RP-SMA (M)
C		SMB (M)
D		N-Type (M)
E		TNC (M)
F		BNC (M)
G		MCX (M)
H		MMCX (M)
I		FME (M)
J		FME (F)

Example Configurations :

Part Number	Color / IP Rating / UV Protective Coating	Cable length	Cable Type / Connector Type
AECB1102X S-3000 S	Black / No / No	3000 mm	LMR-100 with SMA (M) (Standard)
AECB1102X A-1000 A	Black / IP66 / No	1000 mm	LMR-100 with FAKRA-D (M)
AECB1102X G-5000 D	White / IP66 / Yes	5000 mm	LMR-100 with N-Type (M)

Note :

- For the standard part number (AECB1102X**S-3000**S), please refer to the packaging at the end of the document
- For custom configurations (AECB1102X-), MOQs, pricing and packaging changes may apply



5101 Hidden Creek Ln Spicewood TX 78669
 Phone: 512-371-6159 | Fax: 512-351-8858
 For terms and conditions of sales, please visit:
www.abracon.com

REVISED: 03-17-21

ABRACON IS
 ISO9001-2015
 CERTIFIED

5G/4G/LTE - External Blade Antenna

AECB1102X

Request Samples



Check Inventory



115.6 x 21.7 x 5.8 mm
RoHS/RoHS II Compliant
MSL Level = 1

Electrical Specification

Parameter	Specification			Unit
	Min	Typ	Max	
Operating Frequency	600		6000	MHz
VSWR			3.5	
Peak Gain			2	dBi
Impedance		50		Ω
Polarization	Linear			
Power Rating			10	W

Mechanical Specification

Parameter	Specification
Overall Dimension	115.6 x 21.7 x 5.8 mm
Radome Material	ABS
Mounting Type	Adhesive
RF Cable Type	LMR-100
RF Cable Length	3 m
RF Connector	SMA (M)

Environmental Specification

Parameter	Specification
Operating Temperature	-40°C to +85°C
Storage Temperature	-40°C to +85°C
RoHS Compliance	Yes
PB Free	Yes
MSL	1
ESD Sensitive	No
Relative Humidity	Up to 95%
Vibration	10 ~ 55 Hz with 1.5 mm amplitude 2 hrs



5101 Hidden Creek Ln Spicewood TX 78669
Phone: 512-371-6159 | Fax: 512-351-8858
For terms and conditions of sales, please visit:
www.abracon.com

REVISED: 03-17-21

ABRACON IS
ISO9001-2015
CERTIFIED

5G/4G/LTE - External Blade Antenna

AECB1102X

Request Samples



Check Inventory



115.6 x 21.7 x 5.8 mm
RoHS/RoHS II Compliant
MSL Level = 1

Product Dimension

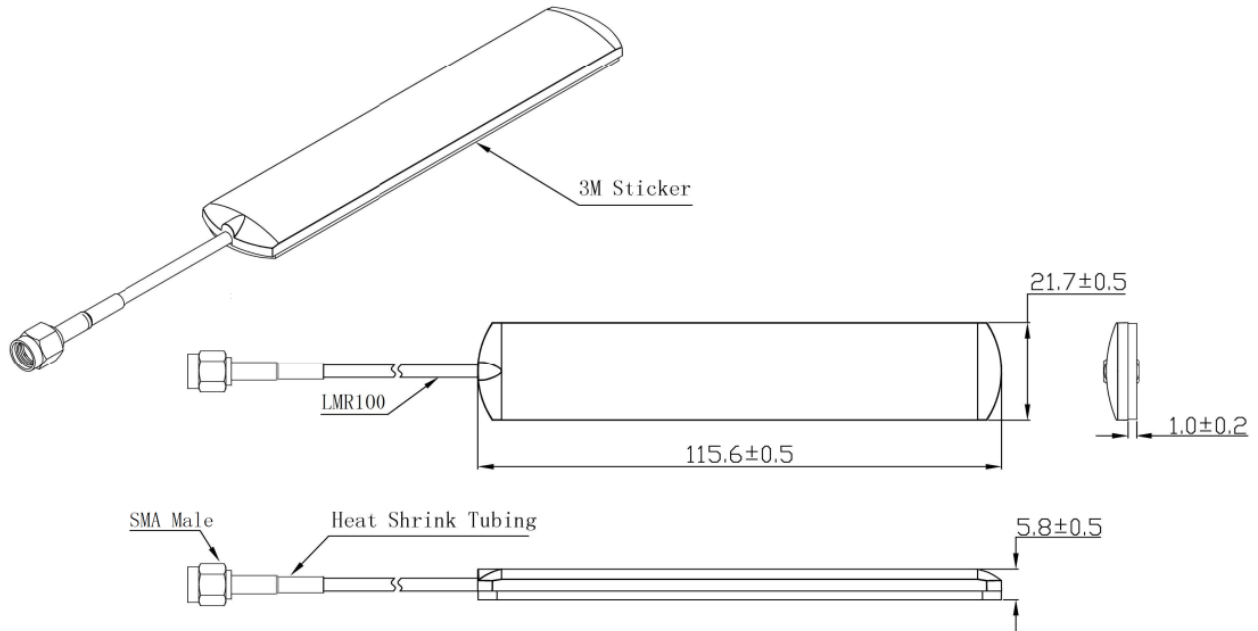

Unit : mm



5101 Hidden Creek Ln Spicewood TX 78669
Phone: 512-371-6159 | Fax: 512-351-8858
For terms and conditions of sales, please visit:
www.abracon.com

REVISED: 03-17-21

ABRACON IS
ISO9001-2015
CERTIFIED

5G/4G/LTE - External Blade Antenna

AECB1102X

Request Samples



Check Inventory



115.6 x 21.7 x 5.8 mm
RoHS/RoHS II Compliant
MSL Level = 1

Test Measurement - VSWR

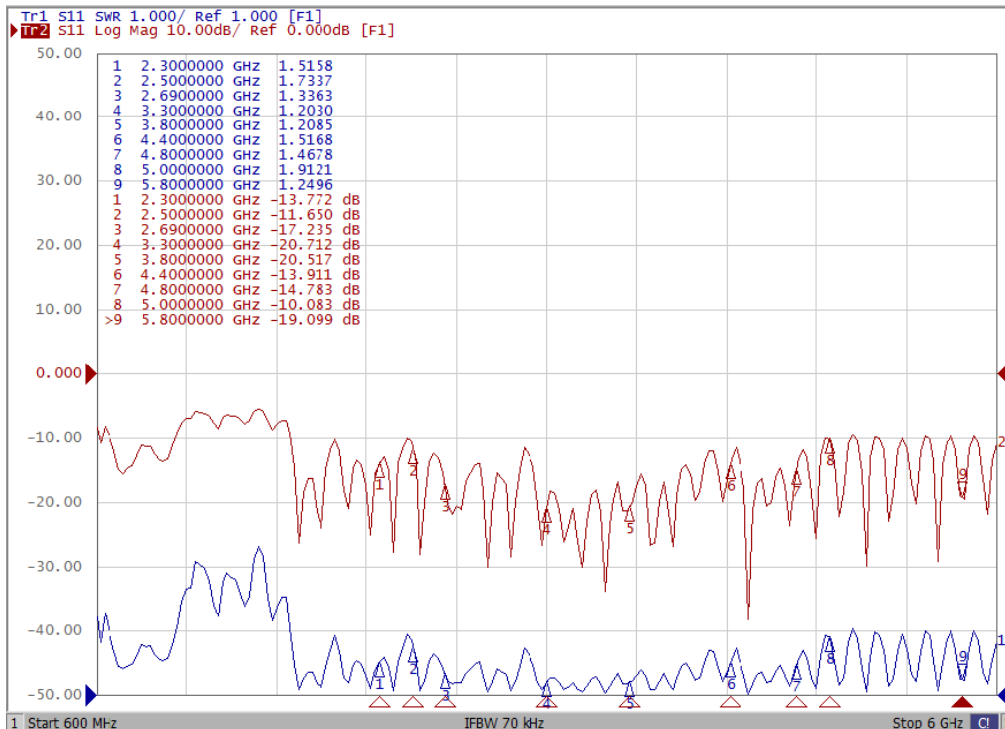
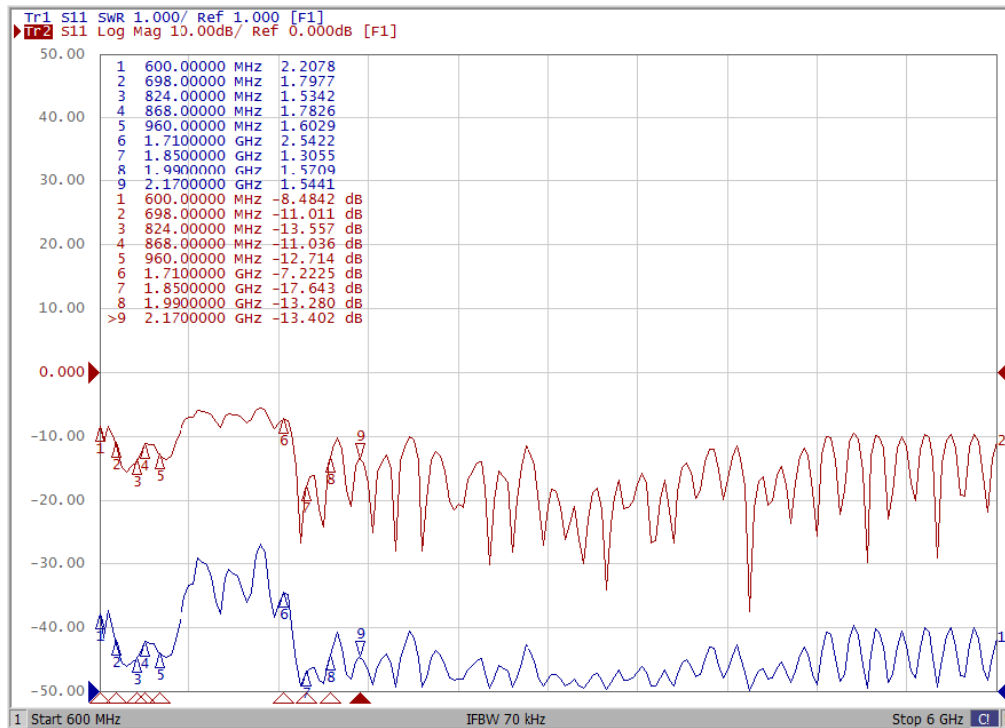

5101 Hidden Creek Ln Spicewood TX 78669
 Phone: 512-371-6159 | Fax: 512-351-8858
 For terms and conditions of sales, please visit:
www.abracon.com

REVISED: 03-17-21

ABRACON IS
 ISO9001-2015
 CERTIFIED

5G/4G/LTE - External Blade Antenna

AECB1102X

Request Samples



Check Inventory



115.6 x 21.7 x 5.8 mm
RoHS/RoHS II Compliant
MSL Level = 1

Radiation Characteristics

2D Pattern

XY - Plane

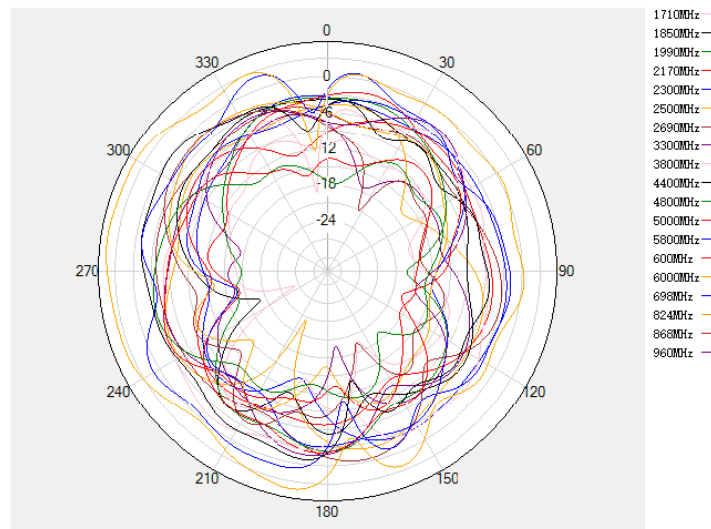

XZ - Plane

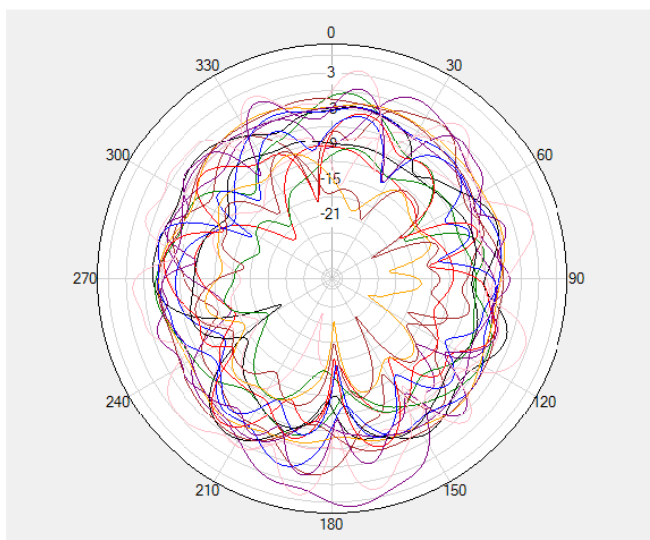

YZ - Plane

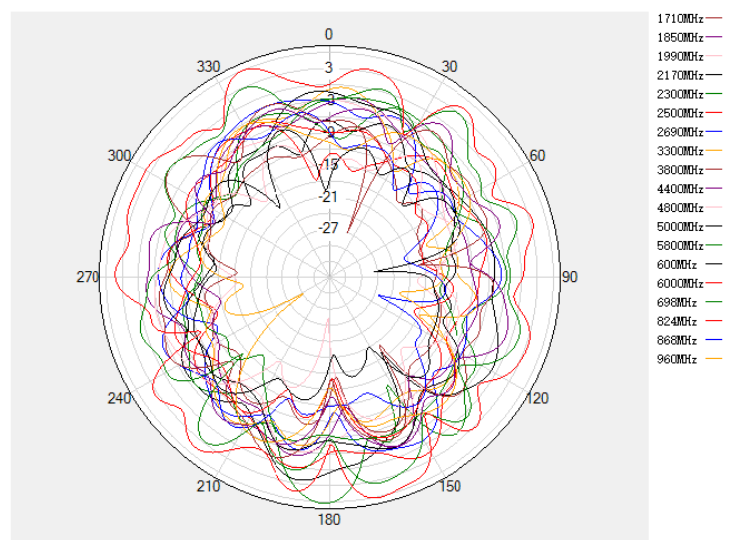

5101 Hidden Creek Ln Spicewood TX 78669
Phone: 512-371-6159 | Fax: 512-351-8858
For terms and conditions of sales, please visit:
www.abracon.com

REVISED: 03-17-21

ABRACON IS
ISO9001-2015
CERTIFIED

5G/4G/LTE - External Blade Antenna

AECB1102X

Request Samples



Check Inventory



115.6 x 21.7 x 5.8 mm
RoHS/RoHS II Compliant
MSL Level = 1

3D Pattern

600 MHz

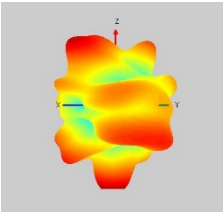

698 MHz

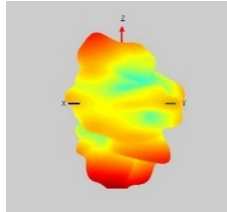

824 MHz

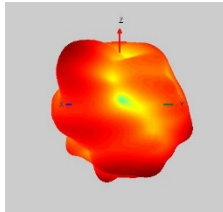

868 MHz

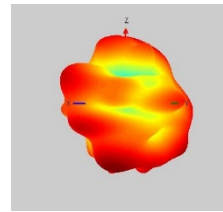

960 MHz

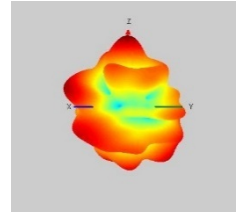

1710 MHz

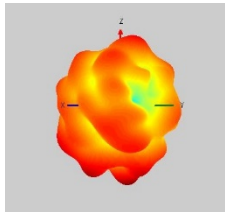

1850 MHz

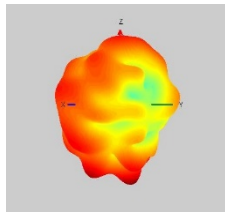

1990 MHz

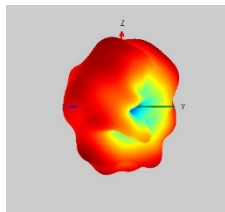

2170 MHz

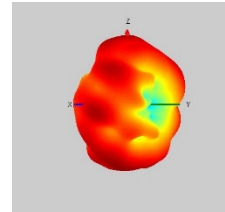

2300 MHz

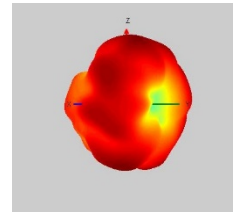

2500 MHz

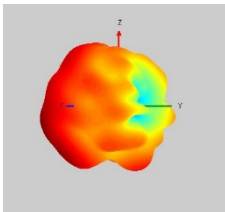

2690 MHz

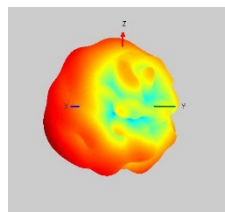

3300 MHz

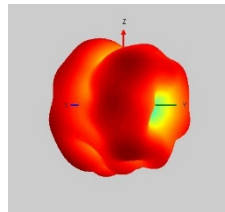

3800 MHz

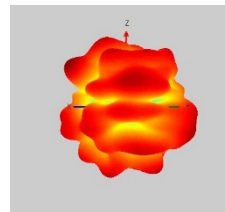

4400 MHz

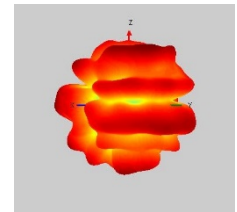

4800 MHz

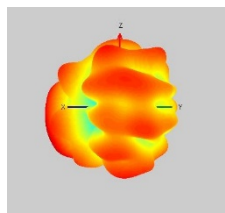

5000 MHz

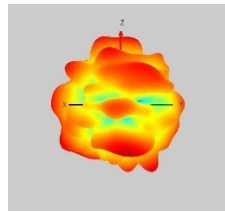

6000 MHz

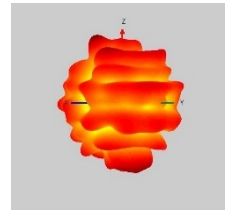

5101 Hidden Creek Ln Spicewood TX 78669
Phone: 512-371-6159 | Fax: 512-351-8858
For terms and conditions of sales, please visit:
www.abracon.com

REVISED: 03-17-21

ABRACON IS
ISO9001-2015
CERTIFIED

5G/4G/LTE - External Blade Antenna

AECB1102X

Request Samples



Check Inventory



115.6 x 21.7 x 5.8 mm
RoHS/RoHS II Compliant
MSL Level = 1

Gain & Efficiency

Frequency (MHz)	Efficiency	Gain (dBi)
600	0.55	0.17
698	0.57	0.58
824	0.59	1.24
868	0.61	1.65
960	0.55	-0.56
1710	0.6	-1.17
1850	0.61	1.22
1990	0.59	1.6
2170	0.63	2.09
2300	0.57	1.75
2500	0.59	0.77
2690	0.57	0.92
3300	0.53	0.82
3800	0.52	-0.09
4400	0.47	-1.41
4800	0.51	-1.18
5000	0.49	-1.1
5800	0.53	1.99
6000	0.57	2.12

Packaging Information

Number of Antenna/ Carton : 250 pcs
Dimension of the Carton : 700 x 320 x 155 mm
Weight of 1pc of antenna : 55 g
Weight of the Carton : 15 kg

ATTENTION: Abracon LLC's products are COTS – Commercial-Off-The-Shelf products; suitable for Commercial, Industrial and, where designated, Automotive Applications. Abracon's products are not specifically designed for Military, Aviation, Aerospace, Life-dependent Medical applications or any application requiring high reliability where component failure could result in loss of life and/or property. For applications requiring high reliability and/or presenting an extreme operating environment, written consent and authorization from Abracon LLC is required. Please contact Abracon LLC for more information.



5101 Hidden Creek Ln Spicewood TX 78669
Phone: 512-371-6159 | Fax: 512-351-8858
For terms and conditions of sales, please visit:
www.abracon.com

REVISED: 03-17-21

ABRACON IS
ISO9001-2015
CERTIFIED