



## Standard And Fast Recovery Rectifiers

### DESCRIPTION

This series of high-current single-phase bridge rectifiers are constructed with hermetically sealed rectifiers built with the same design and construction techniques used in military applications for the upmost in reliability. These include voidless glass encapsulation and internal "Category 1" metallurgical bonds. These 10A to 25A rectifier bridges are available in multiple working peak reverse voltage ratings per leg.

**Important:** For the latest information, visit our website <http://www.microsemi.com>.

### FEATURES

- Current ratings to 25 amps
- $V_{RWM}$  from 100 to 600 volts (see [part nomenclature](#) for all options)
- 150 °C junction temperature
- Surge ratings to 150 amps
- Recovery times to 500 ns
- MIL-PRF-19500 similarity
- RoHS compliant versions available

### APPLICATIONS / BENEFITS

- Fuse-in-glass diodes design
- Electrically isolated aluminum case
- Controlled avalanche characteristics

### MAXIMUM RATINGS

Parameters/Test Conditions	Symbol	Value	Unit
Junction and Storage Temperature	$T_J$ and $T_{STG}$	-65 to +150	°C
Thermal Resistance Junction-to-Case	$R_{\theta JC}$	20	°C/W
Thermal Resistance Junction-to-Case per package	$R_{\theta JC}$	4.0	°C/W
Maximum Average DC Output Current: @ $T_C = 55\text{ °C}$	$I_O$	25 10 20 10	A
Maximum Average DC Output Current: @ $T_C = 100\text{ °C}$	$I_O$	18.5 6 14 6	A
Forward Surge Current (Peak): @ $T_C = 100\text{ °C}$	$I_{FSM}$	150 50 150 50	A
Solder Temperature @ 10 s		260	°C



(Actual appearance may vary)

**NA or NB  
Package**

#### MSC – Lawrence

6 Lake Street,  
Lawrence, MA 01841  
Tel: 1-800-446-1158 or  
(978) 620-2600  
Fax: (978) 689-0803

#### MSC – Ireland

Gort Road Business Park,  
Ennis, Co. Clare, Ireland  
Tel: +353 (0) 65 6840044  
Fax: +353 (0) 65 6822298

#### Website:

[www.microsemi.com](http://www.microsemi.com)

**MECHANICAL and PACKAGING**

- CASE: Aluminum
- TERMINALS: Tin/lead or RoHS compliant matte tin
- MARKING: Alternating current input: AC  
Cathode positive output: +  
Anode negative: -  
Part number is printed on the body
- WEIGHT: 679 series = 20 grams (typical), 680 series = 10 grams (typical)
- See [Package Dimensions](#) on last page.

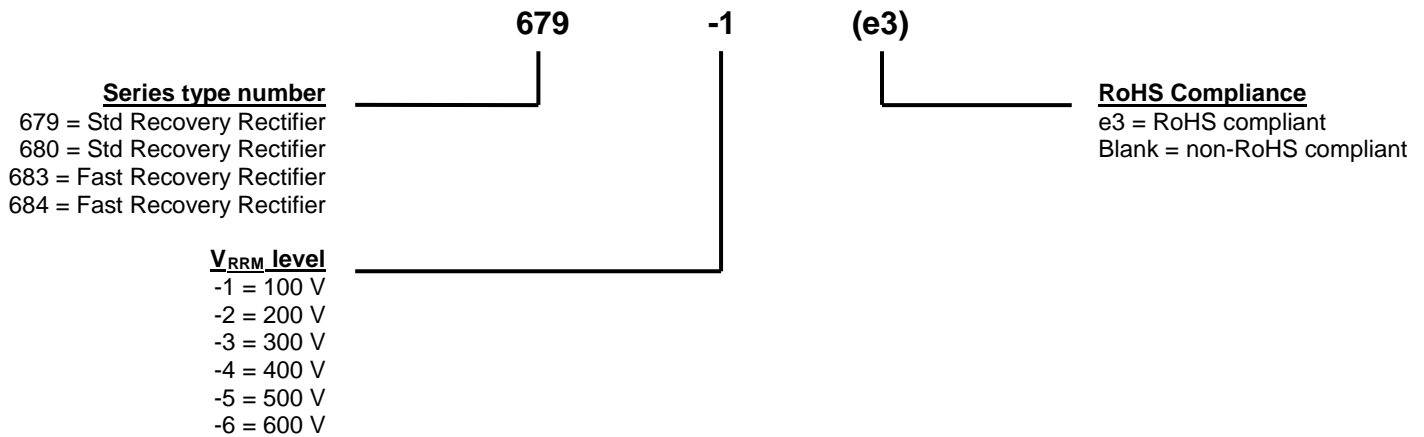
**PART NOMENCLATURE**

**SYMBOLS & DEFINITIONS**

Symbol	Definition
$I_{FSM}$	Surge Peak Forward Current: The forward current including all nonrepetitive transient currents but excluding all repetitive transients (ref JESD282-B)
$I_O$	Average Rectified Output Current: The Output Current averaged over a full cycle with a 50 Hz or 60 Hz sine-wave input and a 180 degree conduction angle.
$V_F$	Forward Voltage: A positive dc anode-cathode voltage the device will exhibit at a specified forward current.
$I_R$	Reverse Current: The dc current flowing from the external circuit into the cathode terminal at the specified voltage $V_R$ .
$V_{(BR)}$	Breakdown Voltage: A voltage in the breakdown region.
$V_{RWM}$	Working Peak Reverse Voltage: The peak voltage excluding all transient voltages (ref JESD282-B). Also sometimes known historically as PIV.
$t_{rr}$	Reverse Recovery Time: The time interval between the instant the current passes through zero when changing from the forward direction to the reverse direction and a specified decay point after a peak reverse current occurs.

**ELECTRICAL CHARACTERISTICS**

PART NUMBER	MAX FORWARD VOLTAGE PER LEG $V_F$ (Note 2)	MAX REVERSE PEAK CURRENT $I_R @ V_{RWM}$ (Note 1)		MAX RECOVERY TIME $t_{rr}$ ( $I_F = 1.0 A$ , $I_{RM} = 1.0 A$ , $I_{R(REC)} = 0.5 A$ )
	@ 25 °C	@ 25 °C	@ 100 °C	
	Volts	$\mu A$	$\mu A$	ns
<b>679</b>	1.2 @ 10 A	20	200	-
<b>680</b>	1.2 @ 2 A	2	50	-
<b>683</b>	1.2 @ 5 A	10	200	500
<b>684</b>	1.2 @ 2 A	5	100	500

**NOTES:** 1. MAX WORKING PEAK REVERSE VOLTAGE ( $V_{RWM}$ ) numbering:

PART NUMBER				WORKING PEAK REVERSE VOLTAGE $V_{RWM}$	MINIMUM BREAKDOWN VOLTAGE $V_{(BR)}$
<b>679-1</b>	<b>680-1</b>	<b>683-1</b>	<b>684-1</b>	100	110
<b>679-2</b>	<b>680-2</b>	<b>683-2</b>	<b>684-2</b>	200	220
<b>679-3</b>	<b>680-3</b>	<b>683-3</b>	<b>684-3</b>	300	330
<b>679-4</b>	<b>680-4</b>	<b>683-4</b>	<b>684-4</b>	400	440
<b>679-5</b>	<b>680-5</b>	<b>683-5</b>	<b>684-5</b>	500	550
<b>679-6</b>	<b>680-6</b>	<b>683-6</b>	<b>684-6</b>	600	660

2. Pulse test: Pulse width 300  $\mu$ sec, duty cycle 2%.

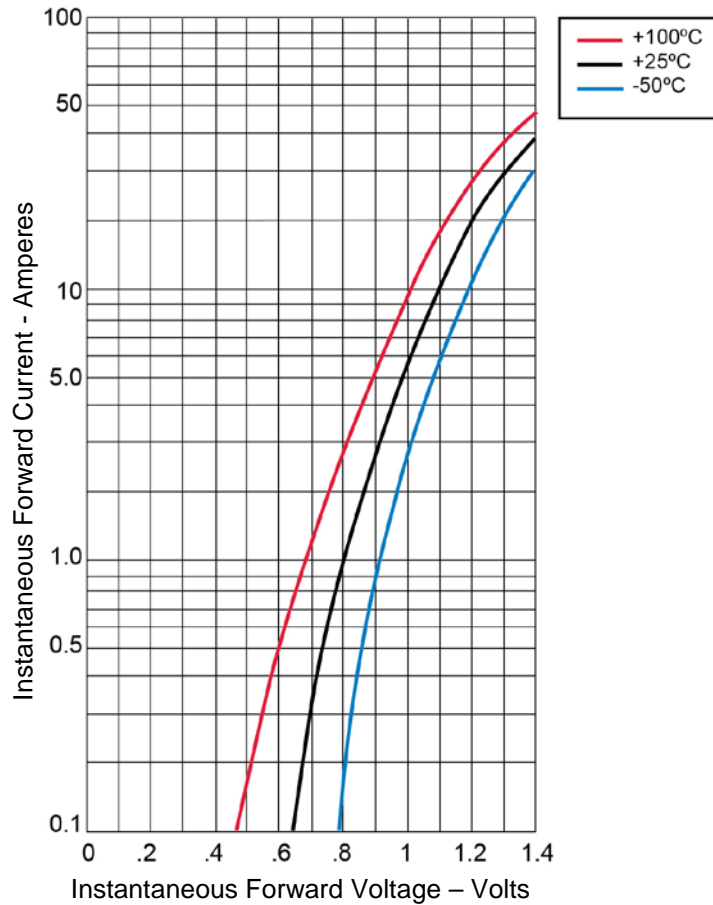
**GRAPHS**

**FIGURE 1**  
Typical Forward Characteristics – Per Leg 679 Series

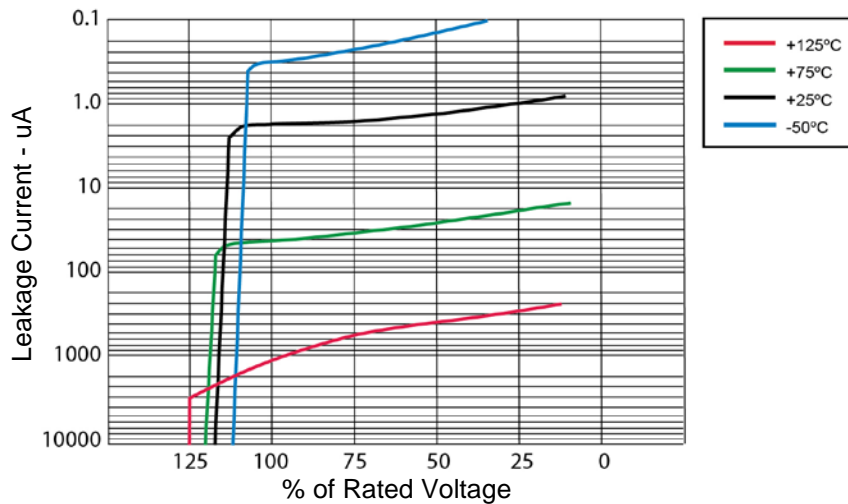

**FIGURE 2**  
Typical Reverse Leakage Current – Per Leg 679 & 683 Series

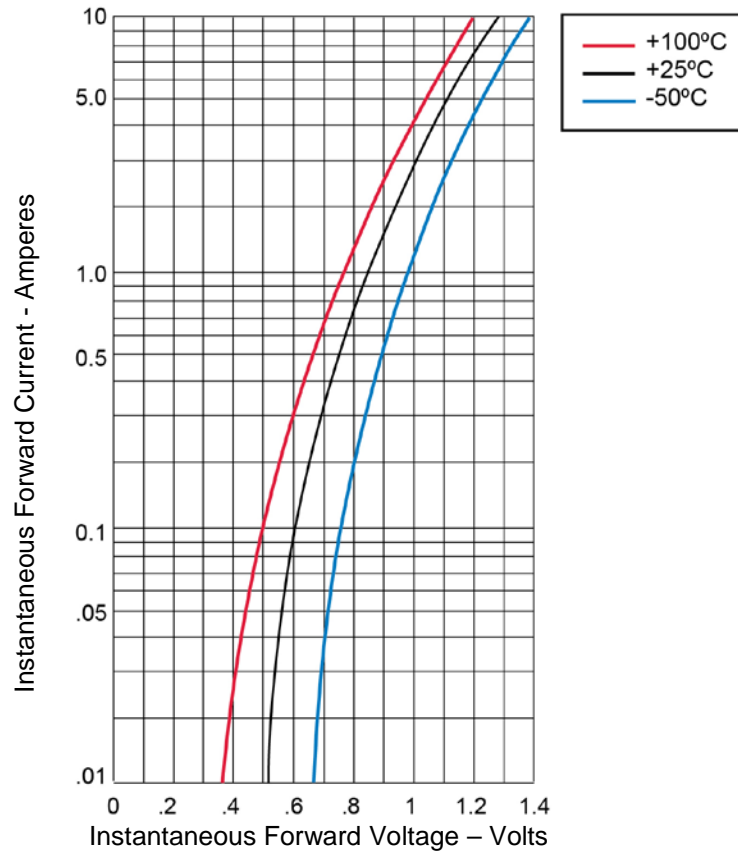
**GRAPHS (continued)**

**FIGURE 3**  
**Typical Forward Characteristics – Per Leg 683 Series**

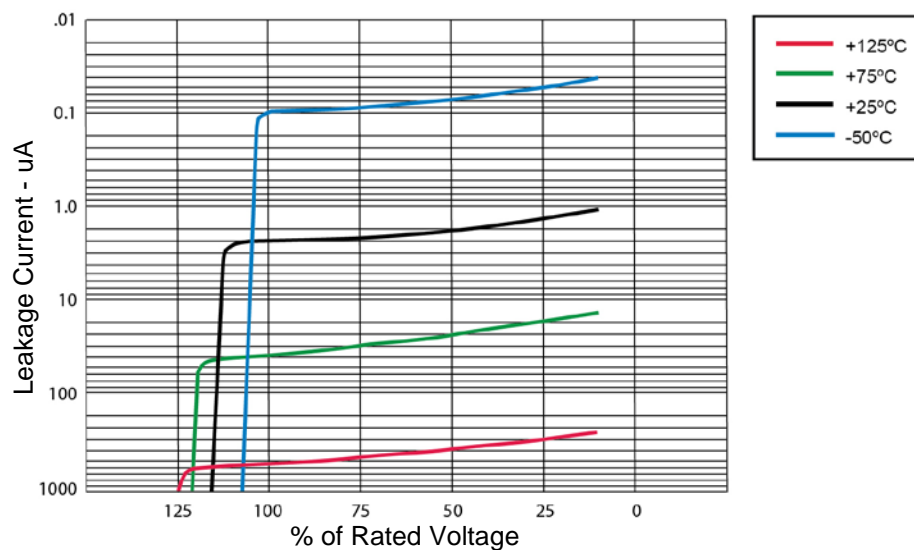

**FIGURE 4**  
**Typical Reverse Leakage Current – Per Leg 680 Series**

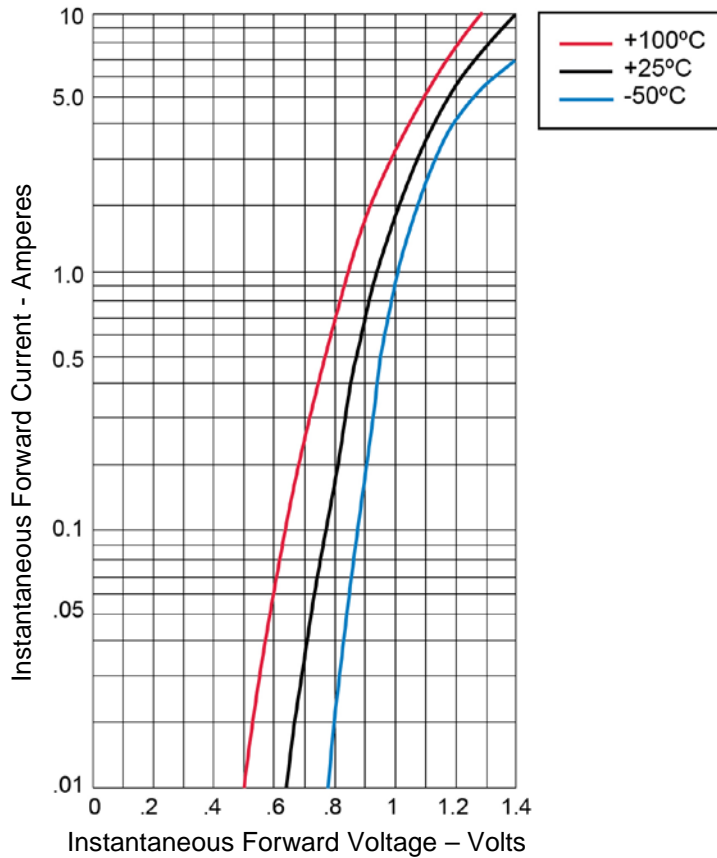
**GRAPHS (continued)**

**FIGURE 5**  
Typical Forward Characteristics – Per Leg 680 & 684 Series

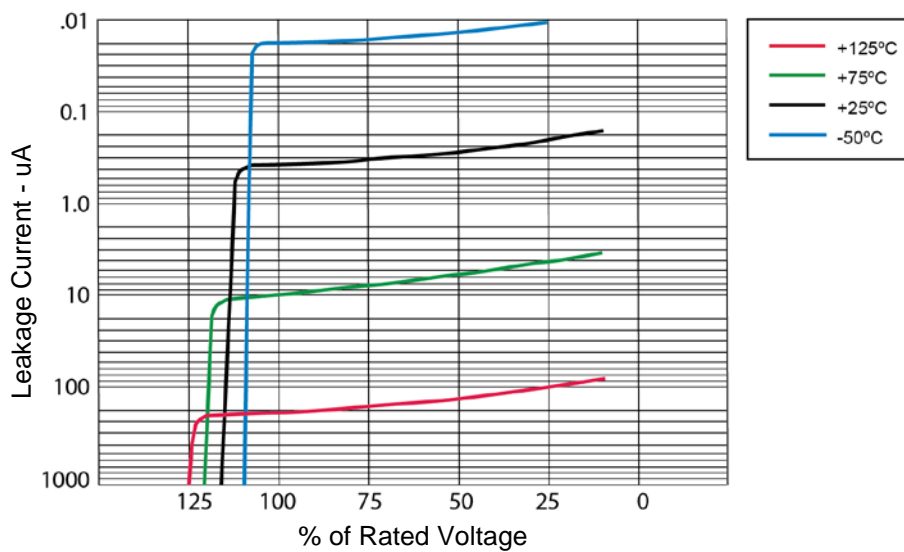

**FIGURE 6**  
Typical Reverse Leakage Current – Per Leg 684 Series

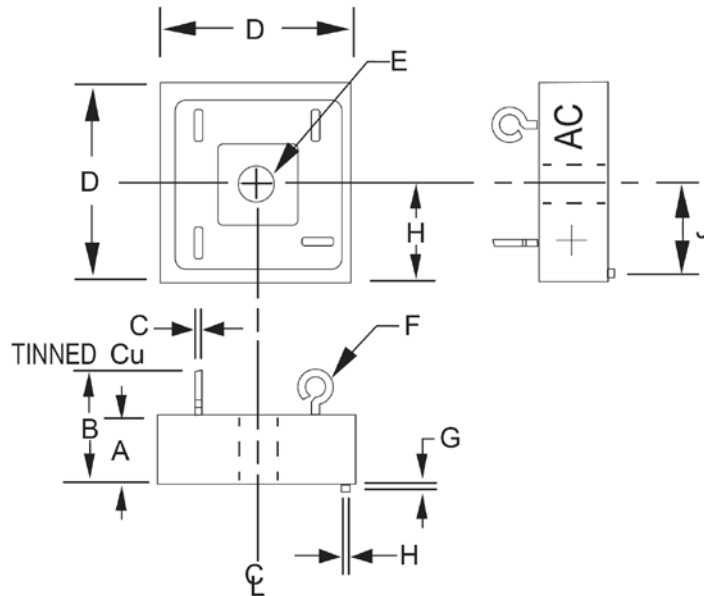
**PACKAGE DIMENSIONS**
**679 & 683**

Ltr	Dimensions	
	Inch	Millimeters
A	0.328 MAX	8.33 MAX
B	0.750 MAX	19.05 MAX
C	0.04	1.02
D	1.125 MAX	25.58 MAX
E	0.193 DIA	4.90 DIA
F	0.09 DIA	2.29 DIA
G	0.062	1.57
H	0.062	1.57
J	0.50	12.7

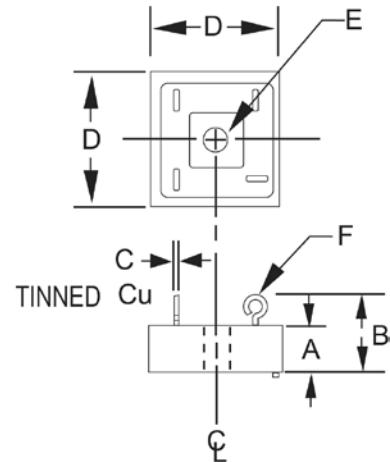
**680 & 684**

Ltr	Dimensions	
	Inch	Millimeters
A	0.250 MAX	6.10 MAX
B	0.570 MAX	14.45 MAX
C	0.04	1.02
D	0.750 MAX	19.05 MAX
E	0.140 DIA	3.56 DIA
F	0.09 DIA	2.29 DIA